



INVERTER

Plug-in option

FR-A8AY

INSTRUCTION MANUAL

Analog output function

Digital output function

PRE-OPERATION INSTRUCTIONS	1
INSTALLATION AND WIRING	2
PARAMETER LIST	3
ANALOG OUTPUT	4
DIGITAL OUTPUT	5

Thank you for choosing this Mitsubishi inverter plug-in option.

This Instruction Manual provides handling information and precautions for use of the equipment. Incorrect handling might cause an unexpected fault. Before using this inverter, always read this Instruction Manual carefully to use the equipment to its optimum performance.

Please forward this Instruction Manual to the end user.

Safety instructions

Do not attempt to install, operate, maintain or inspect the product until you have read through this Instruction Manual and appended documents carefully and can use the equipment correctly. Do not use this product until you have a full knowledge of the equipment, safety information and instructions. In this Instruction Manual, the safety instruction levels are classified into "WARNING" and "CAUTION".



Warning

Incorrect handling may cause hazardous conditions, resulting in death or severe injury.



Caution

Incorrect handling may cause hazardous conditions, resulting in medium or slight injury, or may cause only material damage.

The



Caution

level may even lead to a serious consequence according to conditions. Both instruction levels must be followed because these are important to personal safety.

◆ Electric Shock Prevention



Warning

- While the inverter power is ON, do not open the front cover or the wiring cover. Do not run the inverter with the front cover or the wiring cover removed. Otherwise you may access the exposed high voltage terminals or the charging part of the circuitry and get an electric shock.
- Do not remove the inverter front cover even if the power supply is disconnected. The only exception for this would be when performing wiring and periodic inspection. You may accidentally touch the charged inverter circuits and get an electric shock.
- Before wiring or inspection, LED indication of the inverter unit operation panel must be switched OFF. Any person who is involved in wiring or inspection shall wait for at least 10 minutes after the power supply has been switched OFF and check that there is no residual voltage using a tester or the like. For a short time after the power-OFF, a high voltage remains in the smoothing capacitor, and it is dangerous.
- Any person who is involved in wiring or inspection of this equipment shall be fully competent to do the work.
- The plug-in option must be installed before wiring. Otherwise you may get an electric shock or be injured.
- Do not touch the plug-in option or handle the cables with wet hands. Otherwise you may get an electric shock.
- Do not subject the cables to scratches, excessive stress, heavy loads or pinching. Otherwise you may get an electric shock.

◆ Injury Prevention



Caution

- The voltage applied to each terminal must be the ones specified in the Instruction Manual. Otherwise a burst, damage, etc. may occur.
- The cables must be connected to the correct terminals. Otherwise a burst, damage, etc. may occur.
- The polarity (+ and -) must be correct. Otherwise a burst or damage may occur.
- While power is ON or for some time after power OFF, do not touch the inverter as it will be extremely hot. Touching these devices may cause a burn.

◆ Additional Instructions

The following instructions must be also followed. If the product is handled incorrectly, it may cause unexpected fault, an injury, or an electric shock.

Caution

Transportation and mounting

- Do not install or operate the plug-in option if it is damaged or has parts missing.
- Do not stand or rest heavy objects on the product.
- The mounting orientation must be correct.
- Foreign conductive objects must be prevented from entering the inverter. That includes screws and metal fragments or other flammable substance such as oil.
- If halogen-based materials (fluorine, chlorine, bromine, iodine, etc.) infiltrate into a Mitsubishi product, the product will be damaged. Halogen-based materials are often included in fumigant, which is used to sterilize or disinfect wooden packages. When packaging, prevent residual fumigant components from being infiltrated into Mitsubishi products, or use an alternative sterilization or disinfection method (heat disinfection, etc.) for packaging. Sterilization or disinfection of wooden package should also be performed before packaging the product.

Trial run

- Before starting operation, each parameter must be confirmed and adjusted. A failure to do so may cause some machines to make unexpected motions.

Warning

Usage

- Do not modify the equipment.
- Do not perform parts removal which is not instructed in this manual. Doing so may lead to fault or damage of the product.

Caution

Usage

- When parameter clear or all parameter clear is performed, the required parameters must be set again before starting operations. Because all parameters return to their initial values.
- Static electricity in your body must be discharged before you touch the product.

Maintenance, inspection and parts replacement

- Do not carry out a megger (insulation resistance) test.

Disposal

- The inverter must be treated as industrial waste.

General instruction

- Many of the diagrams and drawings in this Instruction Manual show the inverter without a cover or partially open for explanation. Never operate the inverter in this manner. The cover must be reinstalled and the instructions in the Instruction Manual must be followed when operating the inverter.

— CONTENTS —

1	PRE-OPERATION INSTRUCTIONS	7
1.1	Unpacking and checking the product.....	7
1.1.1	Product confirmation.....	7
1.2	Component names	8
1.3	Specifications	9
2	INSTALLATION AND WIRING	10
2.1	Pre-installation instructions	10
2.2	Installation procedure	10
2.3	Wiring	13
3	PARAMETER LIST	17
4	ANALOG OUTPUT	19
4.1	Connection diagram	19
4.2	Terminals.....	20
4.3	Extended analog output function parameter list.....	21
4.4	Adjustment procedure	22
4.4.1	Analog output signal voltage/current switchover (Pr.309) setting.....	22
4.4.2	Meter calibration	24
4.4.3	Setting output signals	26
4.4.4	Analog meter voltage minus sign output selection (Pr.1019)	26
4.4.5	Adjusting the analog signal (Pr.307, Pr.308, Pr.311, Pr.312).....	27
4.5	Precautions	29

5 DIGITAL OUTPUT

30

5.1	Terminals.....	30
5.2	Digital output function parameter list.....	31
5.3	Parameter setting	31





1 PRE-OPERATION INSTRUCTIONS

1.1 Unpacking and checking the product

Take the plug-in option out of the package, check the product name, and confirm that the product is as you ordered and intact. This product is a plug-in option for the FR-A800 series.

1.1.1 Product confirmation

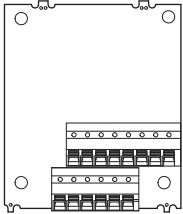
Check the enclosed items.

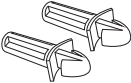
<p>Plug-in option1</p>  A technical drawing of a rectangular plug-in option. It features a central section with two rows of electrical contacts. The top row has 12 contacts, and the bottom row has 12 contacts. There are four circular mounting holes, one in each corner of the main body.	<p>Mounting screw (M3 × 8 mm)2 (Refer to page 10.)</p>  Two screws with a Phillips head and a hexagonal base, shown at an angle.	<p>Spacer2 (Refer to page 10.)</p>  Two L-shaped spacers, one shown from a top-down perspective and one from a side perspective, highlighting their stepped profile.
---	---	--

1.2 Component names

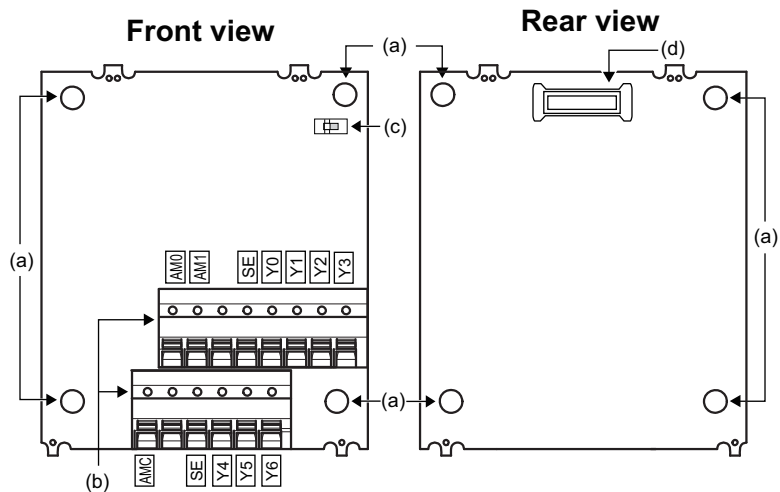

Symbol	Name	Description	Refer to page
a	Mounting hole	Fixes the option to the inverter with screws, or installs spacers.	10
b	Terminal block	Connects the device to input the signal to the inverter, and the device to receive the signal from the inverter.	13
c	Switch for manufacturer setting	Switch for manufacturer setting. Do not change the initial setting ().	—
d	Connector	Connects to the option connector of the inverter.	10

1.3 Specifications

◆ Analog output

Item	Voltage output	Current output
Output signal	0 to ± 10 VDC max (across terminals AM0 to AMC)	0 to 20 mADC (across terminals AM1 to AMC)
Output resolution	3 mV	10 μ A
Applicable meter	DC voltmeter Full-scale ± 10 V (internal impedance: 10 k Ω or more)	DC ammeter Full-scale 20 mA (internal impedance: 300 Ω or less)
	Wiring length maximum 10 m	

◆ Digital output

Open collector output specification: permissible load of 24 VDC 0.1 A

2 INSTALLATION AND WIRING

2.1 Pre-installation instructions

Check that the inverter's input power and the control circuit power are both OFF.

Caution

- Do not mount or remove the plug-in option while the input power is ON. Doing so may damage the inverter or plug-in option.
- To avoid damage due to static electricity, static electricity in your body must be discharged before you touch the product.

2.2 Installation procedure

- (1) Remove the inverter front cover. (Refer to Chapter 2 of the Instruction Manual (Detailed) of the inverter for details on how to remove the front cover.)
- (2) For the two mounting holes (as shown in the next page) that will not be tightened with mounting screws, insert spacers.
- (3) Fit the connector of the plug-in option along the guide of the connector on the inverter, and insert the plug-in option as far as it goes.
- (4) Fit the two locations, the left and right, of the plug-in option securely to the inverter unit by screwing in the supplied mounting screws (tightening torque 0.33 N·m to 0.40 N·m). If the screw holes do not line up, the connector may not be inserted deep enough. Check the connector.

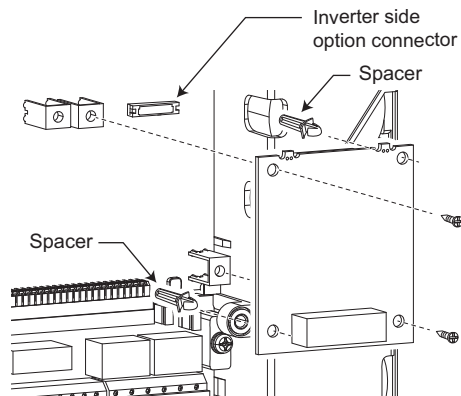

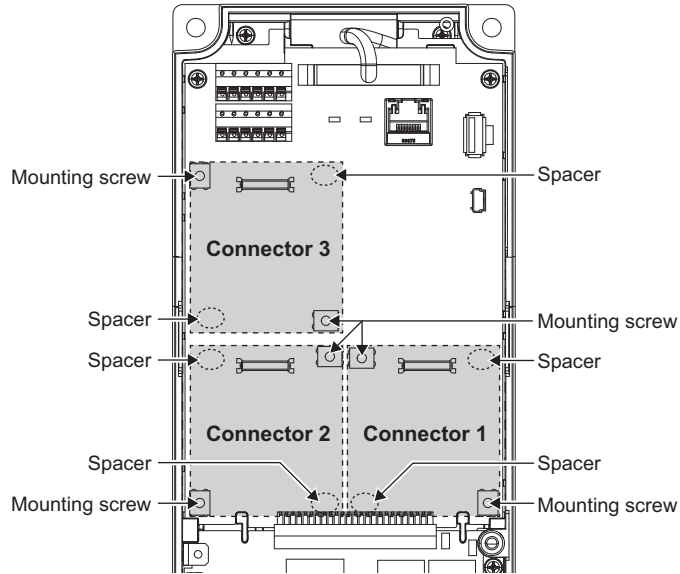

Insertion positions for screws and spacers

NOTE

- When mounting/removing an option, hold the sides of the circuit board. Do not press on the parts on the circuit board. Stress applied to the parts by pressing, etc. may cause a failure.
- Caution must be taken of mounting screws falling off when removing and mounting the plug-in option.
- Only one type of option per inverter may be used. When multiple options are mounted, priority is given to option connectors 1, 2 and 3 on the inverter in this order, and options having a lower priority do not function. (For the positions of the option connectors 1 to 3, refer to [page 11](#).)
- When the inverter cannot recognize that the option unit is mounted due to improper installation, etc., the protective function (E.1 to E.3) is displayed. A different indication will appear according to the mounted position (option connector 1 to 3).

Mounted position	Fault indication
Option connector 1	E. 1
Option connector 2	E. 2
Option connector 3	E. 3

- When removing the plug-in option, remove the two screws on the left and right, then pull it straight out. Pressure applied to the connector and to the option board may break the option.

2.3 Wiring

- (1) For the wiring, strip off the sheath of a cable, and use it with a blade terminal. For a single wire, strip off the sheath of the wire and apply directly. Insert the blade terminal or the single wire into a socket of the terminal.

Strip off the sheath for the below length. If the length of the sheath peeled is too long, a short circuit may occur with neighboring wires. If the length is too short, wires might come off.

Wire the stripped cable after twisting it to prevent it from becoming loose. In addition, do not solder it.

Cable sheath stripping length



Crimp the blade terminal.

Insert wires to a blade terminal, and check that the wires come out for about 0 to 0.5 mm.

Check the condition of the blade terminal after crimping. Do not use a blade terminal of which the crimping is inappropriate, or the face is damaged.

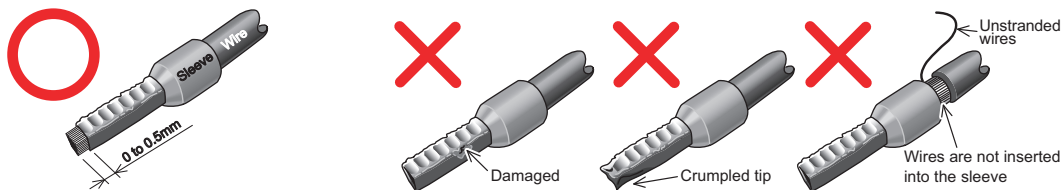

Caution

- After wiring, wire offcuts must not be left in the inverter. They may cause a fault, failure or malfunction.

Blade terminals commercially available (as of February 2012. The product may be changed without notice.)

Cable gauge (mm ²)	Blade terminal model			Manufacturer	Crimping tool name
	With insulation sleeve	Without insulation sleeve	For UL wire *1		
0.3	Al 0,5-10WH	—	—	Phoenix Contact Co., Ltd.	CRIMPFOX 6
0.5	Al 0,5-10WH	—	Al 0,5-10WH-GB		
0.75	Al 0,75-10GY	A 0,75-10	Al 0,75-10GY-GB		
1	Al 1-10RD	A 1-10	Al 1-10RD/1000GB		
1.25, 1.5	Al 1,5-10BK	A 1,5-10	—		
0.75 (for two cables)	Al-TWIN 2 × 0,75-10GY	—	—		

*1 A blade terminal with an insulation sleeve compatible with the MTW wire which has a thick wire insulation.

Cable gauge (mm ²)	Blade terminal product number	Insulation product number	Manufacturer	Crimping tool product number
0.3 to 0.75	BT 0.75-11	VC 0.75	NICHIFU Co.,Ltd.	NH 67

(2) Insert the cable into a socket.

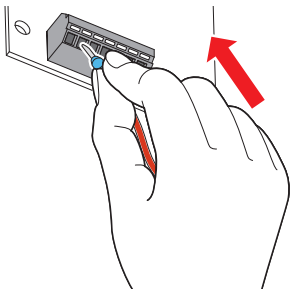

When using a single wire or stranded wires without a blade terminal, push the open/close button all the way down with a flathead screwdriver, and insert the wire.

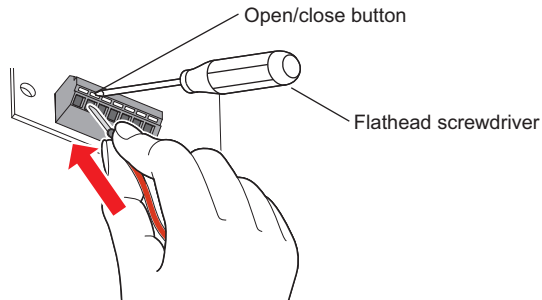

- Wire removal

Pull the wire while pushing the open/close button all the way down firmly with a flathead screwdriver.

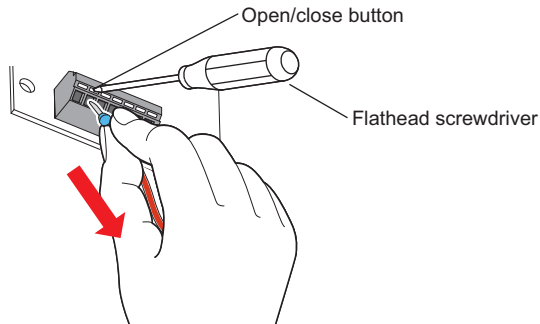

 **NOTE**

- When using stranded wires without a blade terminal, twist enough to avoid short circuit with a nearby terminals or wires.
- Pulling out the wire forcefully without pushing the open/close button all the way down may damage the terminal block.
- Use a small flathead screwdriver (tip thickness: 0.4 mm/tip width: 2.5 mm). If a flathead screwdriver with a narrow tip is used, terminal block may be damaged.

Commercially available product (as of February 2012. The product may be changed without notice.)

Name	Model	Manufacturer
Driver	SZF 0- 0,4 × 2,5	Phoenix Contact Co., Ltd.

- Place the flathead screwdriver vertical to the open/close button. In case the blade tip slips, it may cause an inverter damage or injury.
- When wiring cables to the inverter's RS-485 terminals while a plug-in option is mounted, take caution not to let the cables touch the circuit board of the option or of the inverter. Otherwise, electromagnetic noises may cause malfunctions.

3 PARAMETER LIST

When the FR-A8AY is mounted on the inverter, the following parameters are extended.

Pr.	Pr. group	Refer to page	Setting range	Minimum setting increments	Initial value	Refer to page	
Extended analog output	306	M303	Analog output signal selection	1 to 3, 5 to 14, 17, 18, 21, 24, 32 to 34, 50, 52 to 54, 61, 62, 67, 70, 87 to 97	1	2	19 and later
	307	M340	Setting for zero analog output	0 to 100%	0.1%	0%	
	308	M341	Setting for maximum analog output	0 to 100%	0.1%	100%	
	309	M342	Analog output signal voltage/ current switchover	0, 1, 10, 11	1	0	
	310	M343	Analog meter voltage output selection	1 to 3, 5 to 14, 17, 18, 21, 24, 32 to 34, 50, 52 to 54, 61, 62, 67, 70, 87 to 97	1	2	
	311	M344	Setting for zero analog meter voltage output	0 to 100%	0.1%	0%	
	312	M345	Setting for maximum analog meter voltage output	0 to 100%	0.1%	100%	
	323	M346	AM0 0V adjustment	900 to 1100%	1%	1000%	
	324	M347	AM1 0mA adjustment	900 to 1100%	1%	1000%	
	418	M432	Extension output terminal filter	5 to 50 ms, 9999	1 ms	9999	

Pr.		Pr. group	Refer to page	Setting range	Minimum setting increments	Initial value	Refer to page
Extended analog output	C0 (900)	M310	FM/CA terminal calibration	—	—	—	19 and later
	C1 (901)	M320	AM terminal calibration	—	—	—	
	1019	M305	Analog meter voltage minus sign output selection	0, 1	1	0	
Digital output	313	M410	DO0 output selection	0 to 8, 10 to 20, 22, 25 to 28, 30 to 36, 38, 39, 41 to 54, 56, 57, 61, 63, 64, 68, 70, 84 to 99, 100 to 108, 110 to 116, 120, 122, 125 to 128, 130 to 136, 138, 139, 141 to 154, 156, 157, 161, 163, 164, 168, 170, 184 to 199, 200 to 205, 300 to 305, 9999	1	9999	30 and later
	314	M411	DO1 output selection				
	315	M412	DO2 output selection				
	316	M413	DO3 output selection				
	317	M414	DO4 output selection				
	318	M415	DO5 output selection				
	319	M416	DO6 output selection				

4 ANALOG OUTPUT

4.1 Connection diagram

By setting Pr.306 to Pr.312, analog signals such as the output frequency and output current can be output from the voltage output terminal (AM0) and current output terminal (AM1).

Connect the voltmeter or ammeter as shown below:

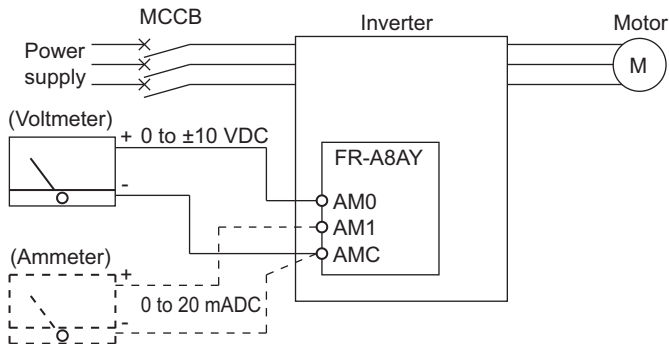

NOTE

- The wiring length for the voltmeter/ammeter should be within 10 m.

4.2 Terminals

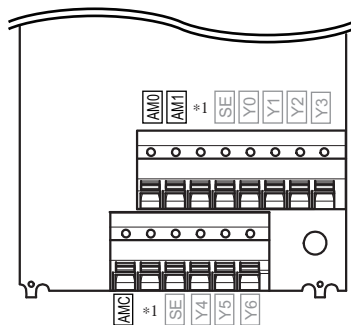

Terminal symbol	Terminal name	Description
AM0	Voltage output terminal	Connects the DC voltmeter (± 10 VDC).
AM1	Current output terminal	Connects the DC ammeter (20 mADC).
AMC	Common terminal	Common terminal for AM0 and AM1.
Y0 to Y6	Used for digital output function. (Refer to page 30 .)	
SE		

*1 Empty terminal. Do not use.

4.3 Extended analog output function parameter list

Parameter number	Name	Setting range	Minimum increments	Initial value
306	Analog output signal selection	1 to 3, 5 to 14, 17, 18, 21, 24, 32 to 34, 50, 52 to 54, 61, 62, 67, 70, 87 to 97	1	2
307	Setting for zero analog output	0 to 100%	0.1%	0%
308	Setting for maximum analog output	0 to 100%	0.1%	100%
309	Analog output signal voltage/current switchover	0, 1, 10, 11	1	0
310	Analog meter voltage output selection	1 to 3, 5 to 14, 17, 18, 21, 24, 32 to 34, 50, 52 to 54, 61, 62, 67, 70, 87 to 97	1	2
311	Setting for zero analog meter voltage output	0 to 100%	0.1%	0%
312	Setting for maximum analog meter voltage output	0 to 100%	0.1%	100%
323	AM0 0V adjustment	900 to 1100%	1%	1000%
324	AM1 0mA adjustment	900 to 1100%	1%	1000%
C0 (900)	FM/CA terminal calibration	—	—	—
C1 (901)	AM terminal calibration	—	—	—
1019	Analog meter voltage minus sign output selection	0, 1	1	0



- Pr.306, Pr.310 can be written even when the inverter is operating.

4.4 Adjustment procedure

4.4.1 Analog output signal voltage/current switchover (Pr.309) setting

Use **Pr.309 Analog output signal voltage/current switchover** to select whether to send the same signal from terminal AM0 (voltage output) and terminal AM1 (current output), or to send the signals separately.

Pr.309 setting value	Description	Terminal	Parameter setting	Calibration parameter
0 (Initial value)	Outputs the same selection signal from both the voltage output terminal (AM0) and the current output terminal (AM1). The signal that set in Pr.306 Analog output signal selection is enabled. (The Pr.310 setting is disabled.)	AM0	Pr.306: Selects the output signal. Pr.307: Output signal value when analog output is zero.	Pr.323 Pr.324 C1 (Pr.901)
10		AM1	Pr.308: Output signal value when analog output is at maximum.	
		AM0	Pr.306: Selects the output signal. Pr.307: Analog output value when output signal is zero.	
AM1		Pr.308: Analog output value when output signal is at maximum.		

Pr.309 setting value	Description	Terminal	Parameter setting	Calibration parameter
1	Outputs separate selection signals from the voltage output terminal (AM0) and the current output terminal (AM1).	AM0	Pr.310: Selects the output signal. Pr.311: Output signal value when analog output is zero. Pr.312: Output signal value when analog output is at maximum.	Pr.323 C0 (Pr.900)
		AM1	Pr.306: Selects the output signal. Pr.307: Output signal value when analog output is zero. Pr.308: Output signal value when analog output is at maximum.	Pr.324 C1 (Pr.901)
AM0		Pr.310: Selects the output signal. Pr.311: Analog output value when output signal is zero. Pr.312: Analog output value when output signal is at maximum.	Pr.323 C0 (Pr.900)	
AM1		Pr.306: Selects the output signal. Pr.307: Analog output value when output signal is zero. Pr.308: Analog output value when output signal is at maximum.	Pr.324 C1 (Pr.901)	
11				

 **NOTE**

- "Analog output" means the voltage (0 to ± 10 V) and current (0 to 20 mA) output from terminals AM0 and AM1; while "output signal" indicates the monitor signal (refer to [page 26](#)) set in parameters **Pr.306** and **Pr.310**.

4.4.2 Meter calibration

(1) Outputting the same signal from terminals AM0 and AM1 (**Pr.309** = "0 or 10")

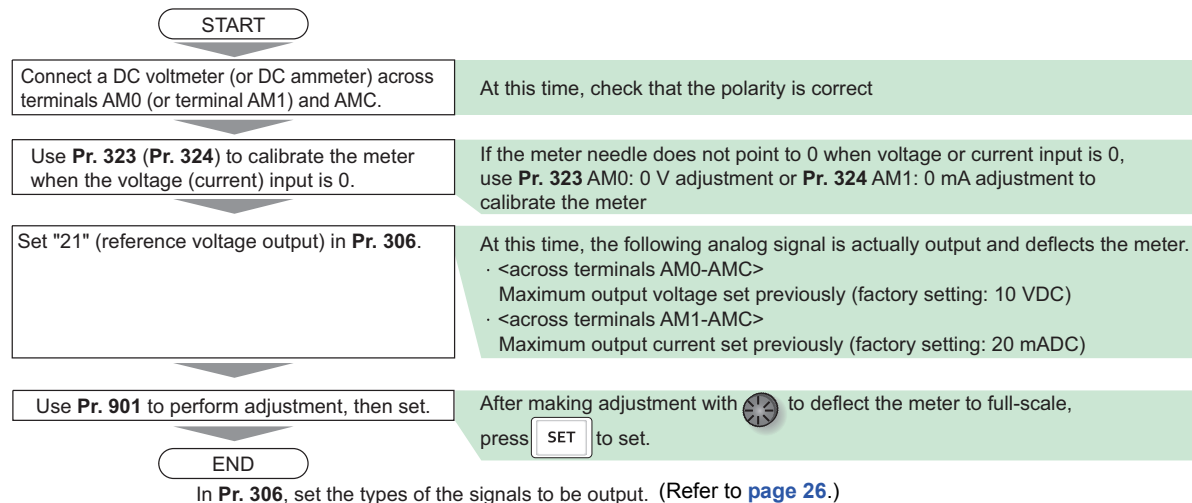

NOTE

- If calibration is performed without setting **Pr.306** = "21 (reference voltage output)", the terminal AM of the inverter is calibrated. To calibrate the extended analog output, always set to "21".
- When the plug-in option used was remounted on another inverter, use **Pr.323** and **Pr.324** to calibrate again.

(2) Outputting separate signals from terminals AM0 and AM1 (Pr.309 = "1 or 11")

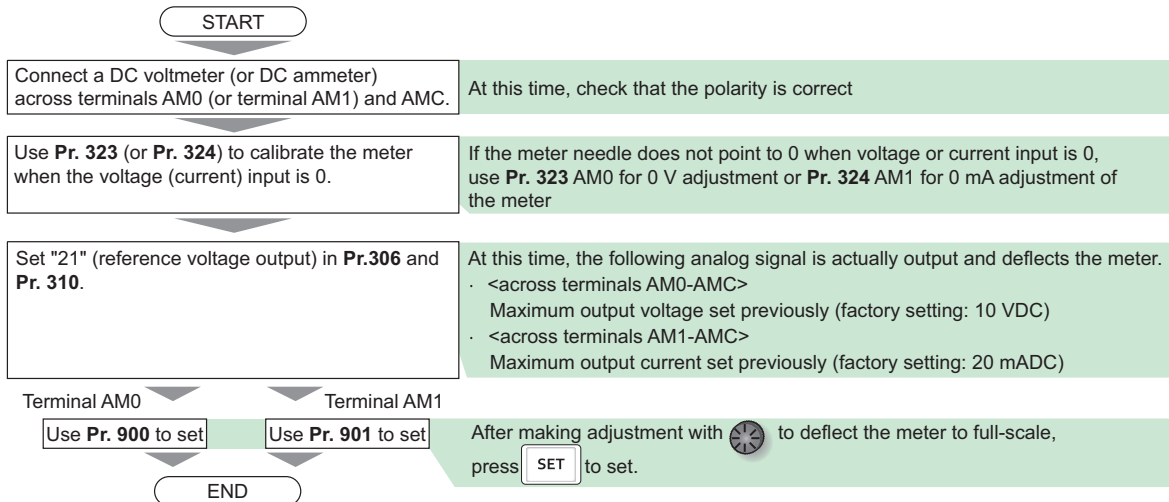

In **Pr. 306** and **Pr. 310**, set the types of the signals to be output. (Refer to [page 26](#).)

NOTE

- If calibration is performed without setting "21 (reference voltage output)" in **Pr.306** or **Pr.310**, the terminal FM, CA, or AM of the inverter is calibrated. To calibrate the extended analog output, always set to "21".
- When the plug-in option used was remounted on another inverter, use **Pr.323** and **Pr.324** to calibrate again.

4.4.3 Setting output signals

Set the output signals to be monitored. Set **Pr.306** to output the same signal from terminals AM0 and AM1, and **Pr.306** and **Pr.310** to output different signals. The AM0 terminal can be used for negative output (from -10 VDC to +10 VDC). The settings of **Pr.306** and **Pr.310** are the same as those of **Pr.54 FM/CA terminal function selection** and **Pr.158 AM terminal function selection**. For the details of **Pr.54** and **Pr.158**, refer to the Instruction Manual (Detailed) of the inverter.

4.4.4 Analog meter voltage minus sign output selection (Pr.1019)

The output from the terminal AM0 (analog voltage output) can be displayed with minus signs on the monitor. For the monitored items that can have minus signs, refer to the description of **Pr.54 FM/CA terminal function selection** and **Pr.158 AM terminal function selection** in the Instruction Manual (Detailed) of the inverter.

Pr.1019 setting	Minus sign output from terminal AM0
0 (initial value)	Output without minus sign (positive values only)
1	Output with minus sign.



- When terminal AM0 (analog voltage output) is "output with a minus sign", the output will be within the -10V DC to +10V DC range.
Connect the meter with which output level is matched.
- Parameter unit (FR-PU07) displays only positive values.
- When the remote output 1 to 4 is set to the terminal AM0 (**Pr.306** = "87 to 90"), regardless of the **Pr.1019** setting, minus outputs can be made.

4.4.5 Adjusting the analog signal (Pr.307, Pr.308, Pr.311, Pr.312)

Use **Pr. 307** or **Pr. 311** to set the values at zero analog output (meter points 0) and **Pr. 308** or **Pr. 312** at maximum analog output (full scale).

When outputting the same signal from terminals AM0 and AM1, use **Pr.307** to set the value at zero analog output and **Pr.308** at maximum analog output. When outputting separate signals from terminals AM0 and AM1, use **Pr.307** (for terminal AM1) and **Pr.311** (for terminal AM0) to set the value at zero analog output, and **Pr.308** (for terminal AM1) and **Pr.312** (for terminal AM0) at maximum analog output. (Refer to [page 22](#).)

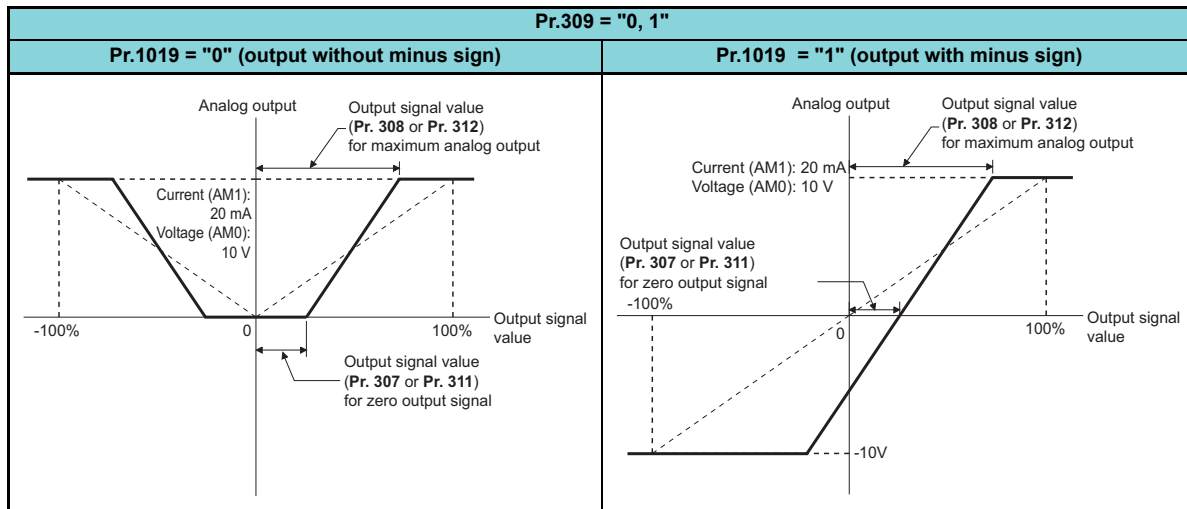

NOTE

- When **Pr.307** \geq **Pr.308** and **Pr.311** \geq **Pr.312**, the output values from the terminals AM0 and AM1 will always be zero.

Pr.309 = "10, 11"

Pr.1019 = "0" (output without minus sign)

Pr.1019 = "1" (output with minus sign)

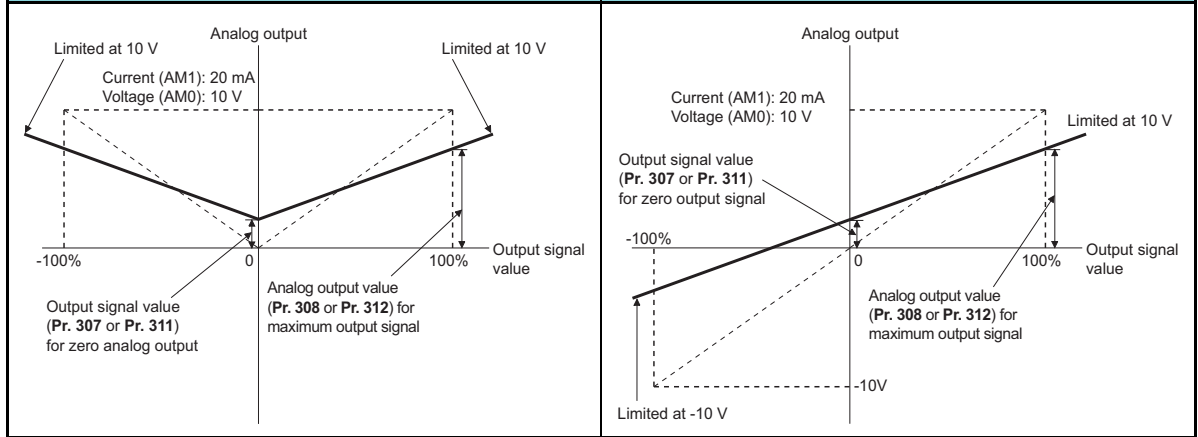

NOTE

- When **Pr.307 = Pr.308** and **Pr.311 = Pr.312**, the output values from the terminals AM0 and AM1 will always be the values that are set in the parameters.

4.5 Precautions

- When using a voltmeter with a lower internal impedance or an ammeter having a greater internal impedance than the value indicated in the specifications (Refer to [page 9](#)), the indicator may not go to full-scale, making it unable to calibrate in some cases.
- When calibrating a meter with small full scale, first adjust the outputs from the terminals AM0 and AM1 accordingly, then connect the meter.

Caution

- This product is initially set to provide the full-scale output of 10 VDC and 20 mADC. Voltmeters (7 VDC or less) or ammeters (14 mADC or less) with a small full-scale value may accidentally be damaged during calibration. Use caution.
- When calibrating the meter using **Pr.323, Pr.324, C0 (Pr.900), and C1 (Pr.901)** while **Pr.309** = "10 or 11", set "0%" in **Pr.307** or **Pr.311**, and "100%" in **Pr.308** or **Pr.312** to prevent calibration value deviation.
- All the outputs are shut off when a protective function (E.1 to E.3) is activated.

5 DIGITAL OUTPUT

5.1 Terminals

Use Pr.313 to Pr.319 to output inverter signals (RUN, SU, etc.) as open collector outputs.

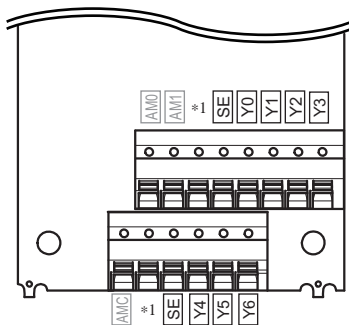

*1 Empty terminal. Do not use.

Terminal symbol	Terminal name	Description
Y0	Digital output terminal	Assigns the function using Pr.313.
Y1		Assigns the function using Pr.314.
Y2		Assigns the function using Pr.315.
Y3		Assigns the function using Pr.316.
Y4		Assigns the function using Pr.317.
Y5		Assigns the function using Pr.318.
Y6		Assigns the function using Pr.319.
SE	Common terminal	Common terminals for the terminals Y0 to Y6. Isolated from the terminal SE of the inverter
AM0	Used for analog output function. (Refer to page 19 .)	
AM1		
AMC		

5.2 Digital output function parameter list

Parameter number	Name	Initial value	Setting range
313	DO0 output selection	9999	0 to 8, 10 to 20, 22, 25 to 28, 30 to 36, 38, 39, 41 to 54, 56, 57, 61, 63, 64, 68, 70, 84 to 99, 100 to 108, 110 to 116, 120, 122, 125 to 128, 130 to 136, 138, 139, 141 to 154, 156, 157, 161, 163, 164, 168, 170, 184 to 199, 200 to 205, 300 to 305, 9999
314	DO1 output selection	9999	
315	DO2 output selection	9999	
316	DO3 output selection	9999	
317	DO4 output selection	9999	
318	DO5 output selection	9999	
319	DO6 output selection	9999	
418	Extension output terminal filter	9999	5 to 50 ms, 9999

5.3 Parameter setting

◆ Setting output signals

Use **Pr.313 to Pr.319** to assign signals to the terminals DO0 to DO6. The settings of **Pr.313 to Pr.319** are the same as those of **Pr.190 to Pr.196 (output terminal function selection)**. For the details of **Pr.190 to Pr.196**, refer to the Instruction Manual (Detailed) of the inverter.



- The same function can be set to two output terminals or more.

◆ Adjusting the output terminal response level (Pr.418)

- The response level of the output terminals can be delayed in a range of 5 to 50 ms. (Operation example for the RUN signal.)

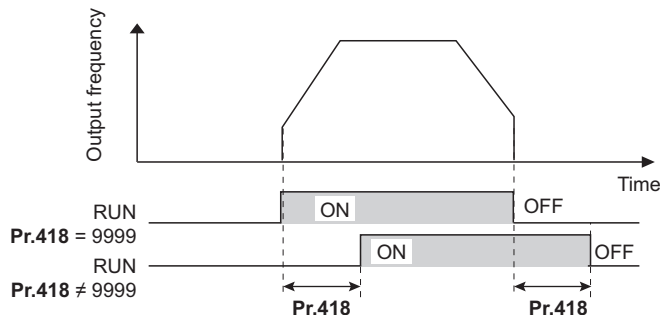

NOTE

- The response level is not adjusted while **Pr.418 = "9999"**.
- When **Pr.157 OL signal output timer** is set for the Overload warning (OL) signal output, the OL signal is output when the set time of (**Pr.157 + Pr.418**) elapses.

MEMO

REVISIONS

* The manual number is given on the bottom left of the back cover.

Print date	* Manual number	Revision
Aug. 2013	IB(NA)-0600497ENG-A	First edition



INVERTER

