

INVERTER
FR-E800

Digest Edition

E800



Design future manufacturing

FR-E800—World's smallest class inverter with high functionality

Ever since the Industrial Revolution, manufacturing technologies have evolved over the years. And now, this is the time for new revolution.

A new era has started. Inverters are connected to the world. We design future manufacturing and what's ahead.





E800

E800-E Ethernet model

E800-SCE Safety communication model



E800 Standard model



IoT



Smart factory made possible through industrial IoT

AI

Artificial intelligence (AI) supports users in various ways



E800

Real-time connection with the host IT system enables centralized or remote monitoring of operation, which further streamlines the production.

1 Improving usability by supporting CC-Link IE TSN as standard

Real-time production data can be collected using efficient protocols, and multiple protocols are supported on the same network, which provides a smart connection solution with various devices.

CC-Link IE TSN >> P11

2 Expanding a range of applications with multi-protocols

Multi-protocol support enables switching between various types of communication networks.

Inverter models that support major global industrial Ethernet networks are available.

**EtherNet/IP
PROFINET
EtherCAT** >> P11

3 Enabling flexible connection with two Ethernet ports

There is no need to use a switching hub.

Two Ethernet ports >> P12

AI technology and smartphone connectivity support initial startup or troubleshooting. Extensive maintenance functions will contribute to improvement in maintainability.

1 Reducing downtime using the AI function

The AI fault diagnosis function is used to identify the cause of a fault, enabling the fastest troubleshooting procedure.

AI fault diagnosis >> P25

2 Enhancing predictive maintenance

Integrating the world's first*¹ corrosive gas environment detection circuit*² makes it possible to identify signs of inverter damage caused by corrosive gas. The corrosion diagnosis function for the control circuit board enables visualization of the environment where the inverter is installed, enhancing maintainability and preventing faults.

Control circuit board corrosion diagnosis >> P22

*1: According to our investigation as of September 10, 2019.

*2: Patent pending.

3 Further facilitating operation with your smartphone

Using smartphones or tablets, you can scan the QR code on the product to access the setup information, or you can access inverters via wireless remote network with a mobile app. This will contribute to reduction in startup time and improvement in maintainability.

Engineering software >> P26

Safety

Advanced harmony
between humans and
FA devices



Performance

Various solutions
achieved by the outstanding
drive performance

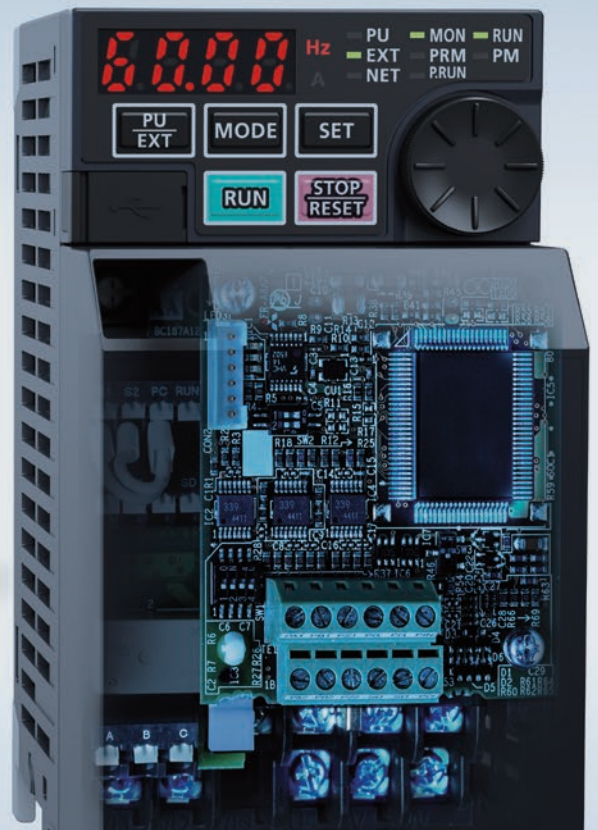

Available when the plug-in option is connected.

E800

Various safety monitoring functions and wireless inverter connection enable stable and safe operation of the system.

1 Attaining both safety and productivity

Speed monitoring functions ensure safe operation for users.

SLS function*1
(Safely-limited speed)

>> P19

2 Reducing the costs for safety

The inverter is compliant with safety integrity level (SIL) 3 of the IEC 61508 standard for functional safety. This will contribute to reduction in the initial safety certification cost. Furthermore, safety products can be used on the existing network as safety communication protocols are supported.

Functional safety

>> P19

3 Ensuring operators' safety by wireless interfaces

Adjustments of inverter parameters and inverter monitoring can be performed wirelessly away from the system, ensuring operators' safety.

Ethernet connection*1

>> P18

*1: Several conditions must be met to use this function.

Various control methods are supported to expand applications in many systems.

1 Supporting various control methods

Various control methods such as Vector control (with encoder), Real sensorless vector control (without encoder), and positioning without using sensors are supported. Premium efficiency motors and PM motors are supported, enabling applications in various solutions.

Control method

>> P17

2 Expanding applications with the enhanced product line

The product line is enhanced as compared to the preceding FR-E700 inverters.

- 18.5 kW / 22 kW supported
- 575 V class supported
- Surrounding air temperature of -20°C to 60°C*1
- Compliance with IEC 60721-3-3(3C2)*2 for corrosive gas concentration
- IP67 models (FR-E846)

Extended capacity range / improved environmental resistance

>> P14

*1: Derating required for 50°C or higher.

*2: Coated model (-60) only

Useful functions for each of the design, operation, and maintenance processes of systems

FR-E800 inverters have various functions to attract more customers by offering safe and reliable operation for a long time.

This is the time to start innovation in the fields of manufacturing.

Design

1



Smart factory

Supporting various networks enable flexible system design.

P10-13

2



Wide range of applications

The extended range of capacities and dimensions supports various applications.

P14-15

3



Higher added values

The outstanding drive performance and various functions create higher added values.

P16-17

Operation

4



Improved safety

Humans and FA devices can work together by enhancing functional safety.

P18-19

5



Energy saving

Use of induction motors or IPM motors contributes to energy saving.

P20-21

Maintenance

6



Improved maintainability

Functions for residual life diagnosis, predictive maintenance, and preventive maintenance support stable system operation.

P22-23

7



Downtime reduction

When a fault occurs, AI analysis and other diagnosis functions solve the problem quickly.

P24-25

Engineering tools

8



Engineering software for further ease of operation

The work efficiency can be improved for each of the design, operation, and maintenance processes.

P26-29

1



Design

Smart factory

Supporting various networks enable flexible system design.

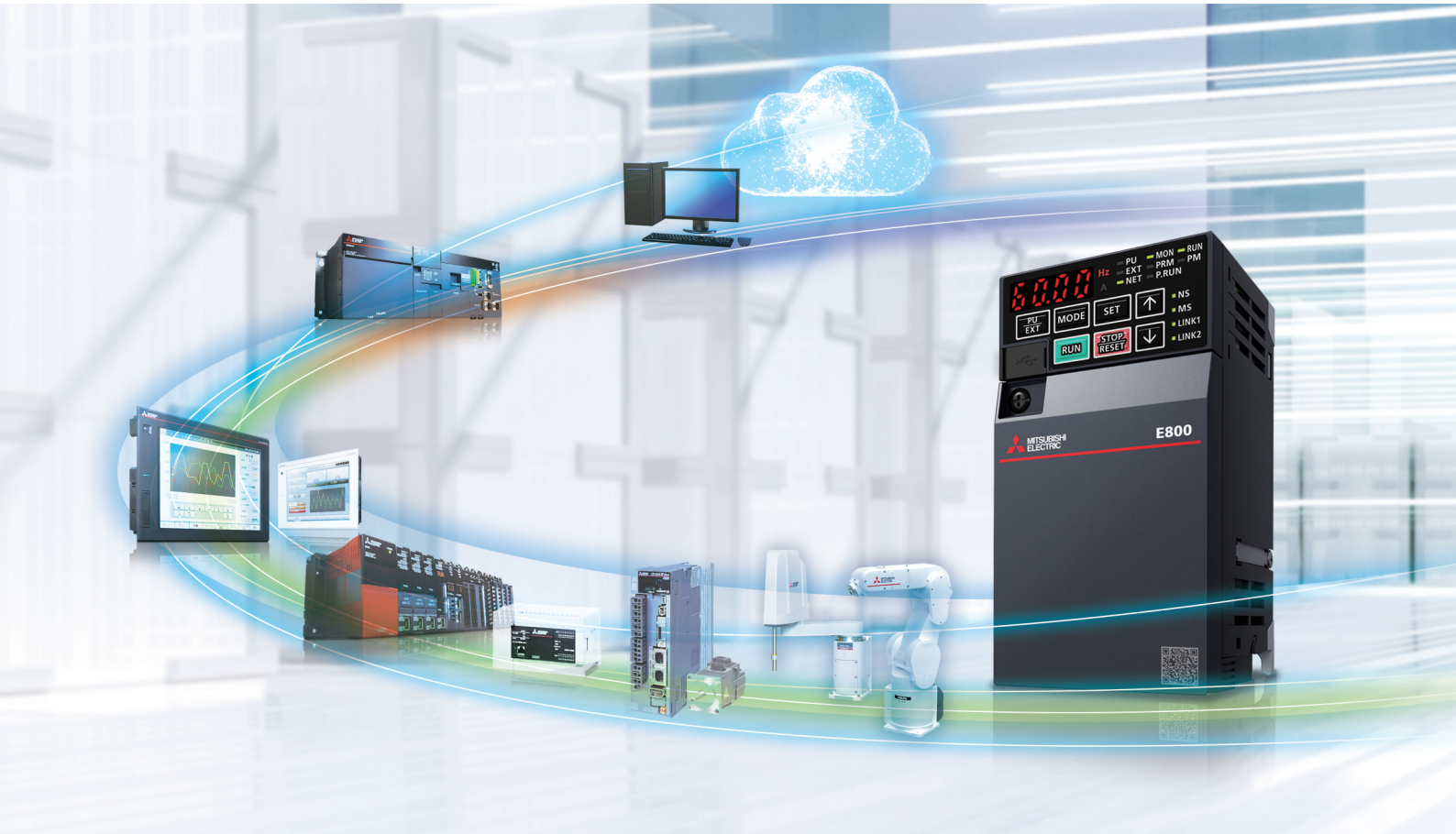

Smart factory

Office

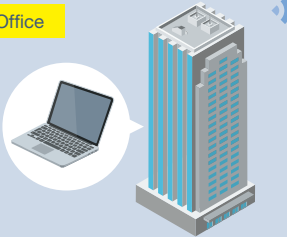

Real-time remote monitoring of operation of each factory enables interconnection between factories. In case of troubles, quick detection enables fast recovery.

Warehouse



Products are stored in a warehouse. Stock control information is shared with the office and the factories.

Factory A

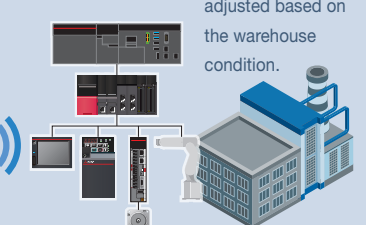

Production volume is adjusted based on the warehouse condition.

Factory B

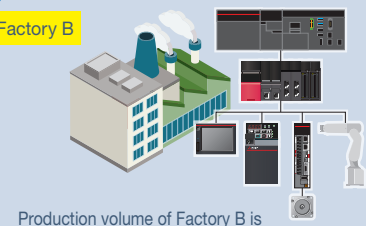

Production volume of Factory B is adjusted efficiently based on the production condition of Factory A.

Internet

1 Less workload required for system construction

▶ CC-Link IE TSN supported as standard

- Deterministic performance of cyclic communication is maintained even when mixed with slower information data (non real-time). This enables TCP/IP communication devices to be used without affecting overall control.
- Network device profiles are available to facilitate network construction.

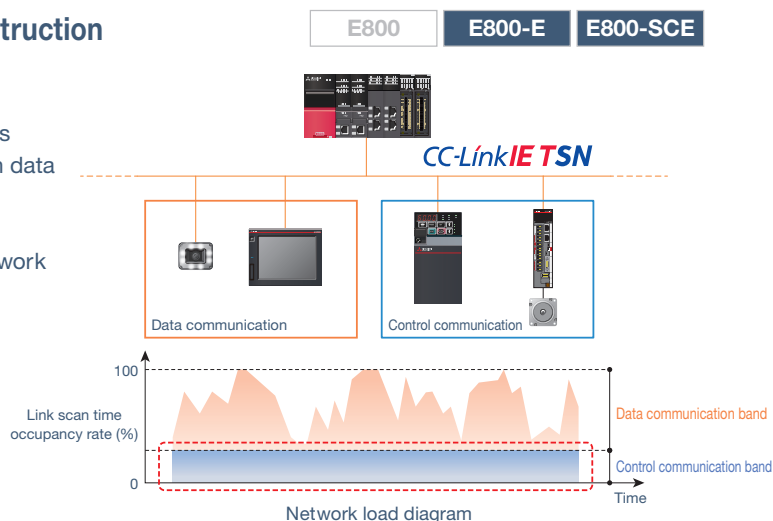

- Non-FA devices that support SLMP and TCP/IP communication can also connect to the network. Inverters can connect to a variety of devices, enabling use with versatile devices.

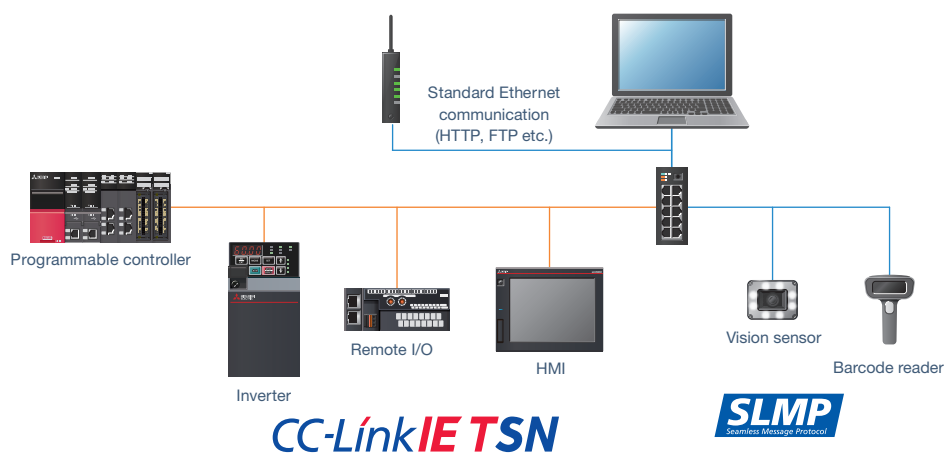

2 Compatibility with global networks

▶ Multi-protocols

Inverter models with the integrated function to support major global industrial Ethernet networks are available. FR-E800 inverters support a variety of open networks without using any options, enabling the use of inverters on the existing network and assuring compatibility with various systems. Users can select a protocol group suitable for the intended system. It is possible to switch between protocols only by setting parameters. (Supported protocols differ depending on the model.)

Supported protocols

Model	CC-Link IE TSN (100Mbps)*1	CC-Link IE Field Network Basic	MODBUS [®] /TCP	PROFINET	EtherNet/IP	BACnet/IP	EtherCAT
FR-E800-□EPA	●	●	●	—	●	●	—
FR-E800-□EPB	○	●	●	●	—	—	—
FR-E800-□EPC	—	—	—	—	—	—	○

*1: 1 Gbps is optional (to be supported).

●: Supported ○: To be supported soon



Design Smart factory

Supporting various networks enable flexible system design.

3 Supporting various topologies

E800

E800-E

E800-SCE

▶ Two Ethernet ports

Two Ethernet ports are provided as standard, enabling flexible connection in line topology without using a switching hub. (A compatible master module is required for ring topology.)

Complex networks can be created just by connecting devices with a cable to a free port. The network can even accommodate changes in the specifications of devices.

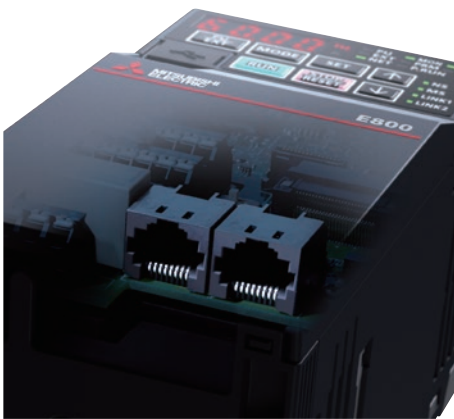

Line topology

The total wiring length can be minimized for large or extensive systems. Eliminating a switching hub allows more flexible installation of inverters even in a narrow space.

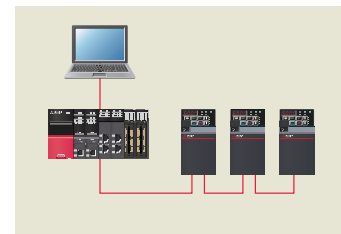

Star topology

A fault in one device does not affect other devices. Fast recovery is enabled when a fault occurs as it is easy to know which device is faulty.

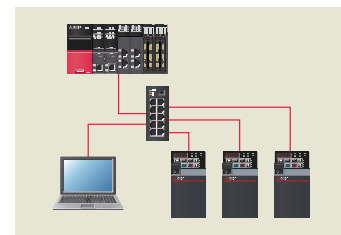

4 Enabling construction of a small-scale synchronous system of inverters

E800

E800-E

E800-SCE

▶ Inverter-to-inverter link function

Communication between multiple inverters is carried out through the I/O device and special register transmission of the PLC function (refer to page 16). A small-scale system can be created by connecting multiple inverters via Ethernet. (The FR-A800-E inverter or the FR-F800-E inverter can be mixed in the system.)

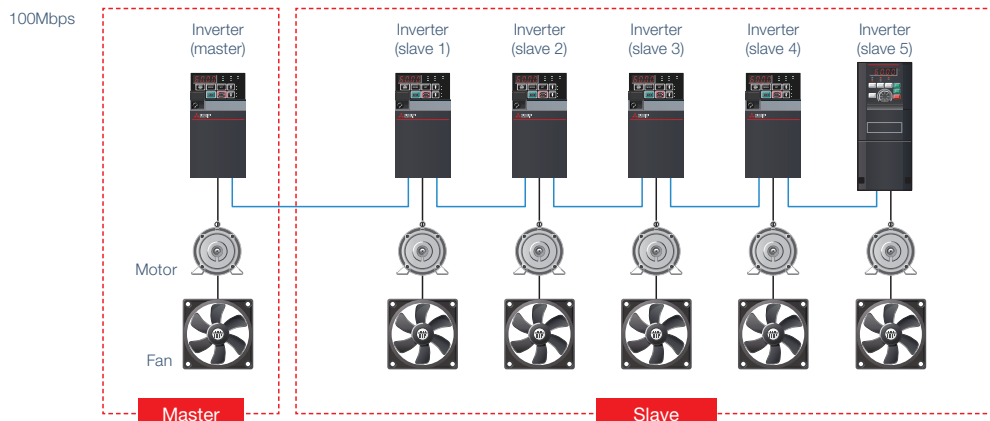

5 Simple configuration with less wiring using safety communication models

E800 E800-E **E800-SCE**

► Safety communication model To be supported soon

Safety communication models support Ethernet-based safety communication protocols certified as compliant with international standards. Safety products can be used on the existing network as safety communication protocols are supported. Safety control can be introduced while reducing the initial cost.

- CC-Link IE TSN Safety Function
- PROFISafe
- CIP Safety
- FSoE (Safety over EtherCAT)

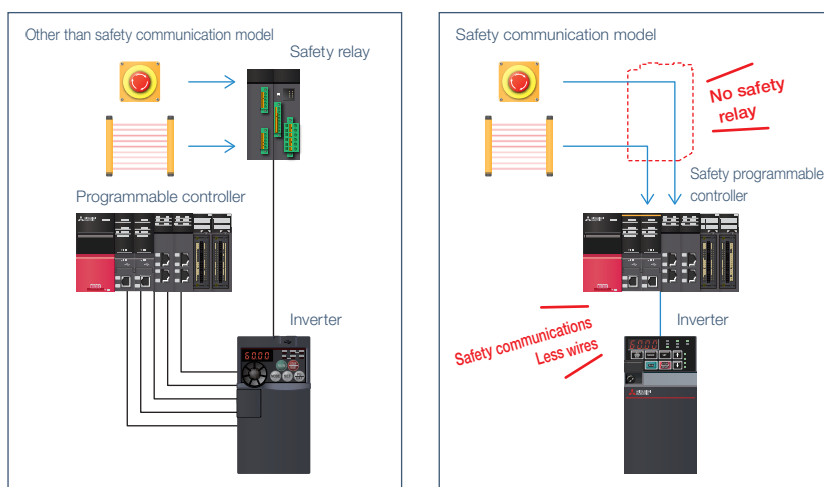

6 Security measures

E800 **E800-E** E800-SCE

► Ethernet IP filtering function

Set the IP address range for connectable network devices to limit connectable devices.

The Ethernet IP filtering function is a means to prevent unwanted access from external devices, but it does not prevent it completely.

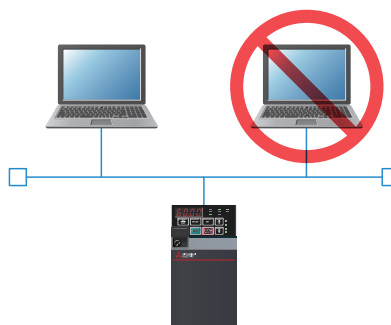

► Ethernet command source selection

Devices which can control the inverter can be limited by setting the IP address range of the network device(s) used to operate it.

► Ethernet function selection

Communication sockets are created only for selected applications such as CC-Link IE TSN or MODBUS/TCP to prevent unwanted access.

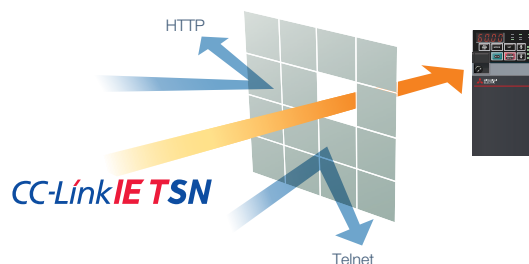

2



Design

Wide range of applications

The extended range of capacities and dimensions supports various applications.



1 Supporting various systems and environments

▶ Extended capacity range

The product line will be extended to include 18.5K and 22K inverters. This will allow use of inverters in large-scale systems.

▶ Increased environmental resistance

Various applications are supported by allowing for corrosive environments or a wide range of surrounding air temperatures.

- Surrounding air temperatures between -20°C and 60°C^{*1} are supported. (-10°C to $+50^{\circ}\text{C}$ for the FR-E700)
- Inverters with circuit board coating (IEC 60721-3-3(3C2))^{*2} are available for improved environmental resistance.

*1: Derating required for 50°C or higher.

*2: Coated model (-60) only.

E800

E800-E

E800-SCE



Water treatment plant



Painting line

2 Effective solution for downsizing equipment

▶ Double ratings

Two rating types of different rated current and permissible load can be selected by setting parameters. The choice of inverters is widened for intended applications of users. When users select the LD rating for light duty applications, inverters with smaller capacities can be used as compared to the FR-E700 series inverters. For example, when the LD rating (light duty) is selected for a 22K inverter, the inverter can drive a motor with a capacity up to 30 kW.

Load	Rating	Overload current rating
Light duty	LD rating	120% 60 s, 150% 3 s (inverse-time characteristics) at surrounding air temperature of 50°C
Normal duty	ND rating	150% 60 s, 200% 3 s (inverse-time characteristics) at surrounding air temperature of 50°C

E800 E800-E E800-SCE



Building water pumps

3 Optimizing the layout inside the enclosure

▶ Flexible installation

When the surrounding air temperature is 40°C or less, multiple inverters can be installed side-by-side. Users can select the most suitable layout for the intended installation area.



Side-by-side installation

E800 E800-E E800-SCE



Ceiling crane

4 Enabling installation in various environments

▶ IP67 models (400 V class: 0.75K to 3.7K) To be supported soon

Installation outside of the enclosure enables installation closer to machines (FR-E846). Since the inverter is compatible with hostile environments such as high humidity and dusty environments, users can easily install the inverter near the machine or in available spaces.

It is possible to reduce line noise by shortening the wiring length between the inverter and the motor.

E800 E800-E E800-SCE



Automotive production line

5 Improving productivity with shorter tact time by the enhanced regeneration function

▶ Built-in brake transistor

With the enhanced power regeneration capability (brake duty: 100% max.), deceleration time can be shortened.*1

*1 : For 200 V class 0.4K and 0.75K models, the brake duty is 30% ED maximum when the lowest resistance value is used. The brake resistor must have a sufficient capacity to consume the regenerative power.
For 200 V class 0.1K and 0.2K models, brake transistors are not built in.

▶ Increased excitation deceleration To be supported soon

When the increased magnetic excitation deceleration function is used, the motor consumes the regenerative power and the deceleration time can be reduced without using a brake resistor.

The tact time can be reduced for a transfer line or the like.

E800 E800-E E800-SCE



Automotive production line



Airport baggage conveyor

3



Design

Higher added values

The outstanding drive performance and various functions create higher added values.



1 Customizing inverter operation for each machine

E800

E800-E

E800-SCE

▶ PLC function

In accordance with the machine specifications, users can set various operation patterns: inverter movements at signal inputs, signal outputs at particular inverter statuses, and monitor outputs, etc. Operation of the system can be customized by the inverter alone.

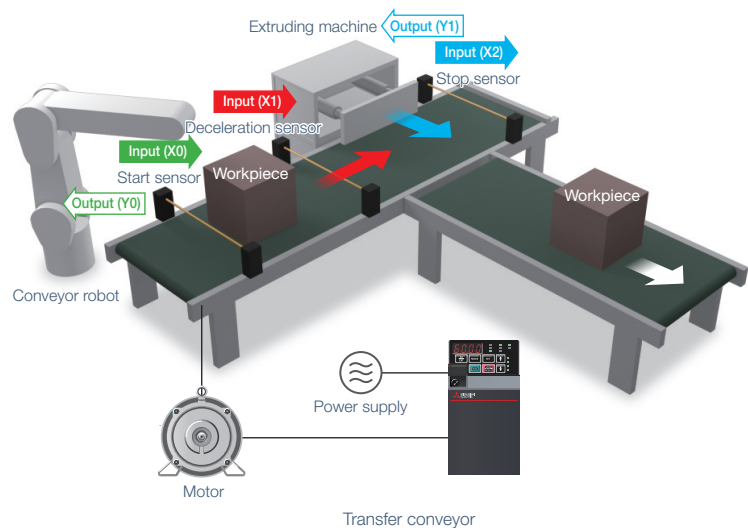

2 Same spare inverters for various applications

▶ Control method

Switching between control methods with the FR-E800 inverter, Vector control for lift application (with the plug-in option), Advanced magnetic flux vector control for conveyors, etc., reduces the number of required spare inverters.

PM sensorless vector control is available when inverters are used with PM motors. High-level control such as positioning control is enabled without using an encoder (to be supported).

▶ Offline auto tuning

Sensorless operation can be performed with non-Mitsubishi Electric general-purpose (induction) motors*1 and permanent magnet (PM) motors*1 as well as Mitsubishi Electric induction motors and PM motors.

Users can use existing motors with new inverters.

*1: Tuning may be disabled depending on the motor characteristics.

E800	E800-E	E800-SCE
------	--------	----------

Control	Speed control	Torque control	Position control	Motor
V/F control	●	–	–	Induction motor
Advanced magnetic flux vector control	●	–	–	
Real sensorless vector control	●	●	–	
Vector control (with plug-in option FR-A8AP E kit used)	○	○	○	PM motor
PM sensorless vector control	●	–	○	

●: Supported ○: To be supported

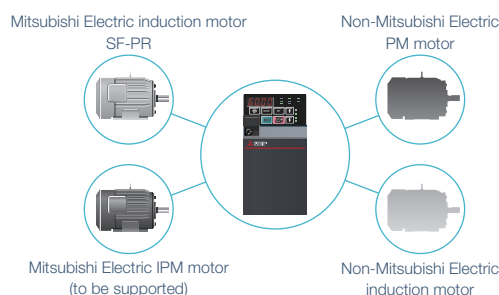

3 Improving work efficiency by powerful high-speed operation

▶ PM sensorless vector control

The torque is not reduced in the high-speed range (up to the rated speed) during PM sensorless vector control as compared with operation using a stepper motor. High-speed system operation improves the tact time.

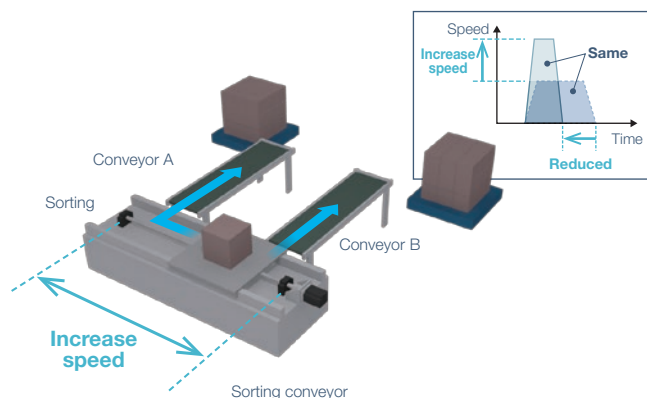

E800	E800-E	E800-SCE
------	--------	----------

4 Expanding the range of applications using inverter options

▶ Plug-in options

In addition to the existing plug-in options to add digital inputs / analog outputs and to support different communication standards, the Vector control compatible option FR-A8AP E kit is supported. Among our compact inverters, FR-E800 inverters are the first to support Vector control.

E800	E800-E	E800-SCE
------	--------	----------

FR-E800 inverter options

Model	Description	Supported
FR-A8AX E kit	16-bit digital input	●
FR-A8AY E kit	Digital output, additional analog output	●
FR-A8AR E kit	Relay output	●
FR-A8AP E kit	Vector control, encoder feedback control	○
FR-E8DS E kit	24VDC input	○
FR-A8NC E kit	CC-Link	●
FR-A8ND E kit	DeviceNet	○
FR-A8NP E kit	PROFIBUS-DP	○

●: Supported ○: To be supported

4



Operation

Improved safety

Humans and FA devices can work together by enhancing functional safety.



1 Wireless access with hard-to-reach inverters

E800

E800-E

E800-SCE

▶ Ethernet communication

Even if inverters are located in a high place, narrow area, or other hard-to-reach place, wireless access enables adjustments of inverter parameters, inverter monitoring (simultaneous monitoring of multiple axes possible), and inverter maintenance such as life diagnosis checks.

The FR-E800 inverter can be connected to FR Configurator2 using a commercially-available industrial wireless LAN*1 access point.

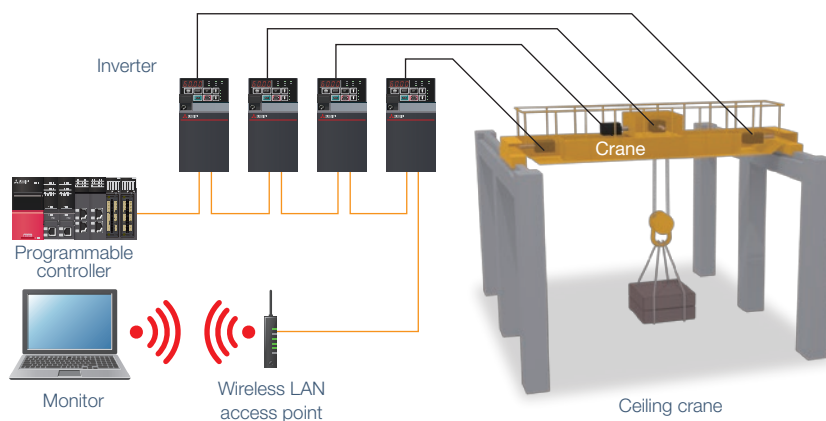

*1: A wireless LAN suitable for the industrial use in severe environments or in environments requiring high reliability (redundancy).

*2: Under certain environments or installation conditions, Ethernet communication through wireless LAN is not as stable as communication through wired LAN. Before starting operation, always check the communication status. Inverter operation (output shutoff, deceleration stop, etc.) when communication fails (due to reasons such as disconnection) can be selected by setting parameters. For applications requiring data transmission or update periodically or within a certain time period, a wired connection is recommended.

2 Attaining both safety and productivity

E800

E800-E

E800-SCE

Functional safety

The inverter is compliant with safety integrity level (SIL) 3 of the IEC 61508 standard for functional safety. This will contribute to reduction in the initial safety certification cost. The following safety functions (IEC 61800-5-2) are supported without using external devices such as an encoder. Several conditions must be met to use this function. This will significantly reduce time required for maintenance or tooling and eliminate external devices such as ones used for monitoring the speed.

		FR-E800, FR-E800-E	FR-E800-SCE	FR-E700-SC
Functional safety category (ISO 13849-1, IEC 61508)		SIL2, PLd, Cat.3	SIL3, PLe, Cat.3	SIL2, PLd, Cat.3
STO	Safety torque off, coasting to stop	●	○	●
SS1	Safe stop 1, deceleration stop	-	○	-
SLS	Safely-limited speed	-	○	-
SBC	Safe brake control	-	○	-
SSM	Safe speed monitor	-	○	-

●: Supported ○: To be supported -: Not supported

STO (safe torque off) function

The shutoff circuit (hardware) securely shuts off the output in case of emergency.

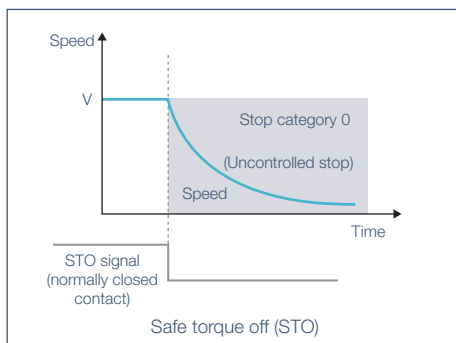

Driving power to the motor is electronically shut off by responding to the input signal from external equipment (output shutoff).

E800

E800-E

E800-SCE

Without STO function

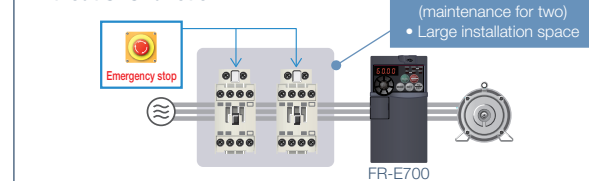

Functional safety integrated

- Magnetic contactor (MC)
- Emergency stop wiring

Safety stop function (STO) cuts down the number of MCs to one! *

- Cost reduction / low maintenance (maintenance for one)
- Small installation space

With STO function

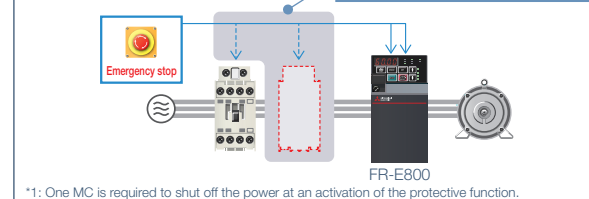

SLS (safely-limited speed) function

To be supported soon

E800

E800-E

E800-SCE

It is possible to continue operation at a safe speed without stopping the production line. The motor speed is calculated based on the current value or other data without using an encoder. This will contribute to wire and cost savings.

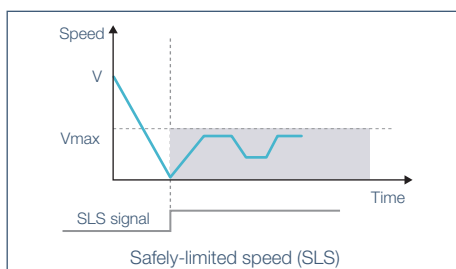

Function to monitor the speed so that the predetermined speed limit is not exceeded.

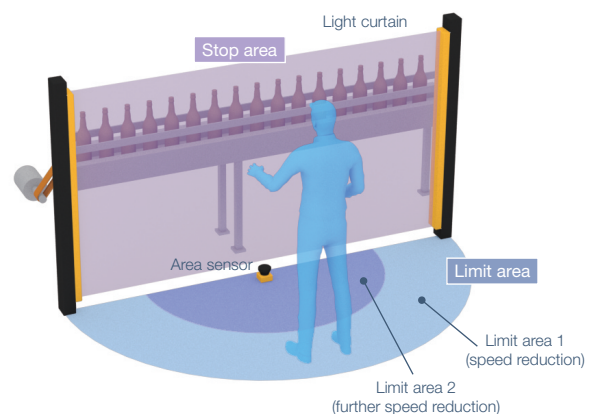

5 Operation Energy saving

Use of induction motors or PM motors contributes to energy saving.



1 Energy saving with motors

E800

E800-E

E800-SCE

▶ General-purpose motor (SF-PR)

The Mitsubishi Electric SF-PR high-performance energy saving motor conforms to the Japanese domestic Top Runner Standard (IE3 equivalent). Its energy-saving operation contributes reduction in the electricity charges, which in turn lowers the running cost. Motor constants are stored in the inverter. Energy-saving operation can be started just by setting parameters.

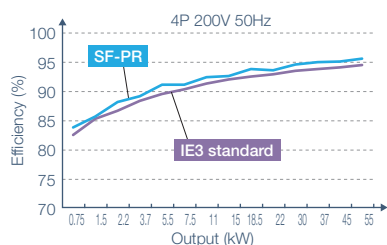

▶ PM motor

The PM motor achieves even higher efficiency as compared to the general-purpose motor (SF-JR). The setting for driving PM motors is enabled just by setting parameters.

Why is a PM motor so efficient?

- No current flows to the rotor (secondary side), and no secondary copper loss is generated.
- Magnetic flux is generated with permanent magnets, and less motor current is required.

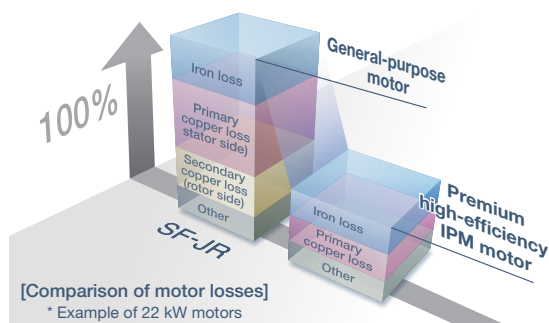

2 Supporting step-by-step energy saving solution

E800

E800-E

E800-SCE

► Compatibility with both induction motors and PM motors

Further energy saving operation is enabled by using IE3/IE4 induction motors or permanent magnet embedded (PM) motors. FR-E800 inverters support both induction motors and PM motors, enabling step-by-step replacement of existing devices. Users can replace inverters first and then motors. There is no need to replace them all at once.

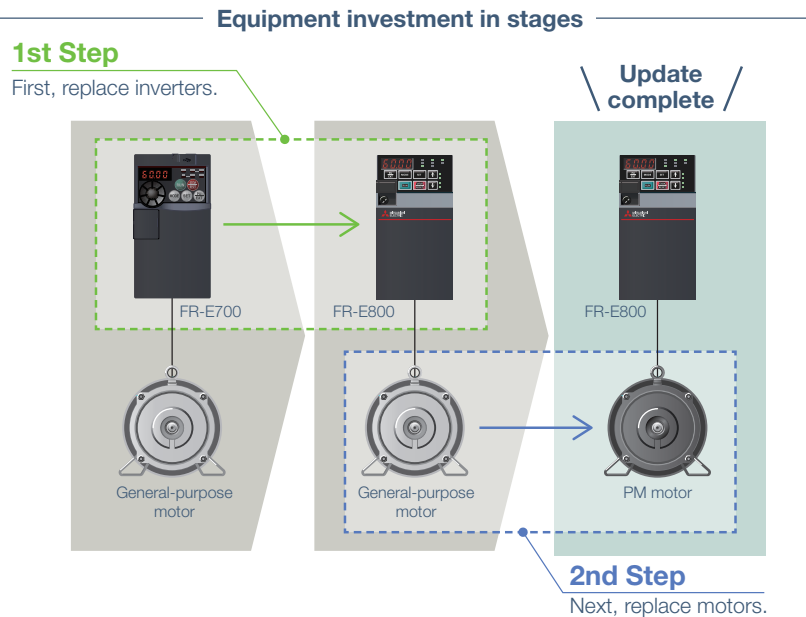

3 Energy saving with inverters

► Advanced optimum excitation control To be supported soon

A large starting torque can be provided with the same motor efficiency under Optimum excitation control. Without the need of troublesome adjustment of parameters (acceleration/deceleration time, torque boost, etc.), acceleration is done in a short time. Also, energy saving operation with the utmost improved motor efficiency is performed during constant-speed operation. When Advanced magnetic flux vector control is selected, Advanced optimum excitation control is available.

► Energy saving monitoring

The energy saving effect can be checked using an operation panel, output terminal, or network. The output power amount measured by the inverter can be output in pulses. The cumulative power amount can be easily checked.*1

*1: This function cannot be used as a meter to certify electricity billings.

E800

E800-E

E800-SCE

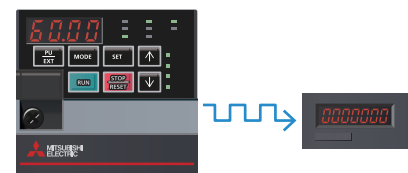
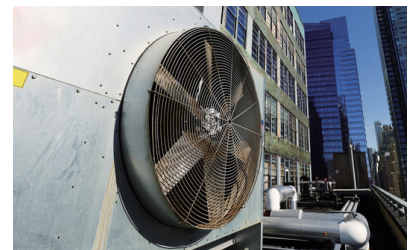

4 Energy saving with the regenerative option

► Power regeneration function (optional)

While the motor rotates to drive the machine during power driving, the machine rotates the motor during regenerative driving, which results in energy saving since the motor serves as a generator which returns the power to the power supply. By using the multifunction regeneration converter (FR-XC) as a common converter, the power returned from an inverter during regenerative drive can be supplied to another inverter, which in turn saves energy.

E800

E800-E

E800-SCE

[Power regeneration]

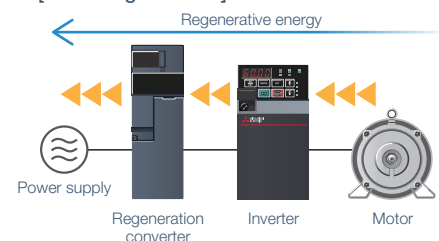



Functions for residual life diagnosis, predictive maintenance, and preventive maintenance support stable system operation.

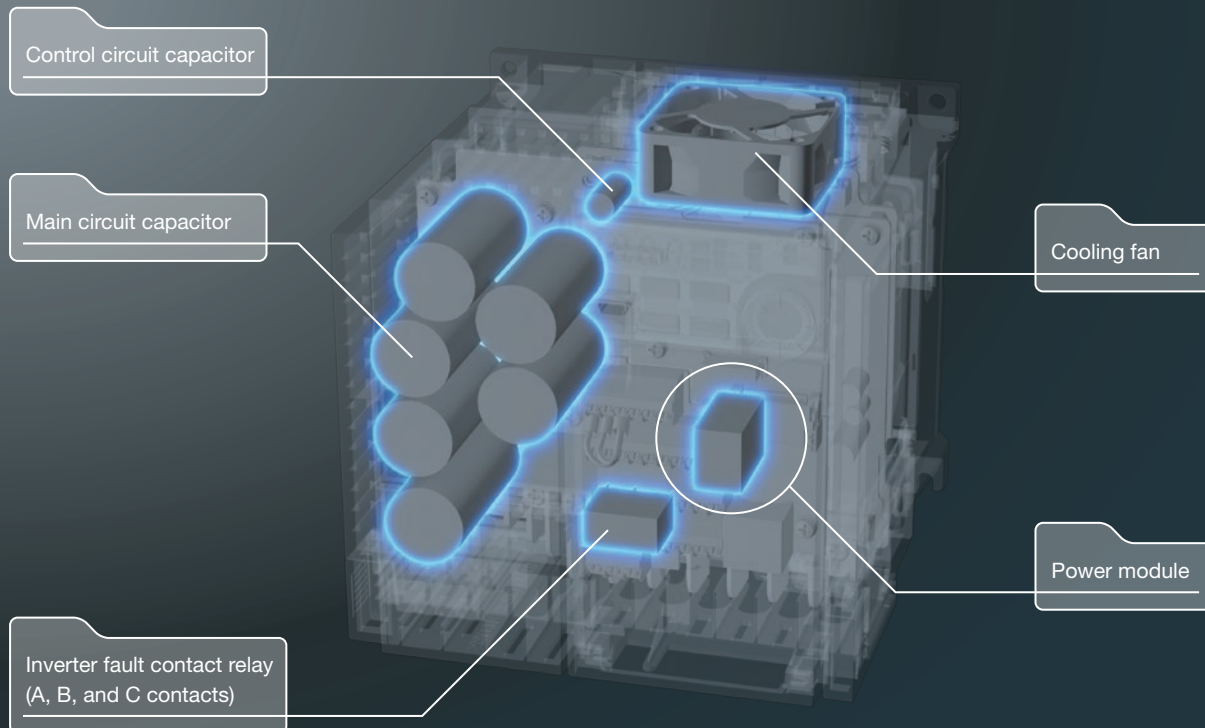

Example: FR-E840-3.7K

1 Supporting scheduled maintenance planning

▶ Control circuit board corrosion diagnosis

The world's first*¹ corrosive gas environment detection circuit*² makes it possible to identify signs of inverter damage caused by hydrogen sulfide or other corrosive gas. Equipment downtime will be reduced as the function notifies operators when the production environment needs to be improved (for coated models (-60) only).

*1: According to our investigation as of September 10, 2019.

*2: Patent pending.

▶ Enhanced life diagnosis function

Availability of life diagnosis checks is extended. This enhanced diagnosis function ensures reliable operation of the system.

The design life of cooling fans and capacitors has been extended to 10 years*³.

*3: Surrounding air temperature: annual average 40°C (free from corrosive gas, flammable gas, oil mist, dust and dirt)
Output current: 80% of the inverter rated current
Since the design life is a calculated value, it is not a guaranteed value.



Sewage treatment plant

Extended

- Main circuit capacitor online life diagnosis
- Inverter fault contact relay (A, B, and C contacts) life diagnosis
- Power module life diagnosis
- Control circuit capacitor life diagnosis
- Cooling fan life diagnosis
- Inrush current limit circuit life diagnosis

2 Real-time monitoring for early fault detection

E800

E800-E

E800-SCE

► Load characteristics fault detection function

When a mechanical fault such as clogging of the filter occurs, the inverter outputs a warning or shuts off the output to prevent system damage.

The speed-torque characteristic is stored while no fault occurs, enabling comparison between the measured data and the stored data.

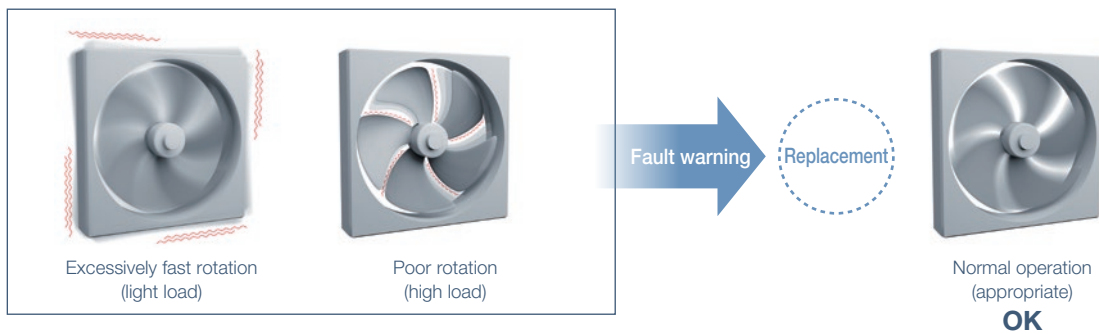

► Current detection function

Faults caused by stiff rotation of motor shaft (increased load) or cracks in the belt (decreased load) can be detected through the motor output current.

If the output current exceeds the predetermined value, a signal is output to inform the user of the faulty device.

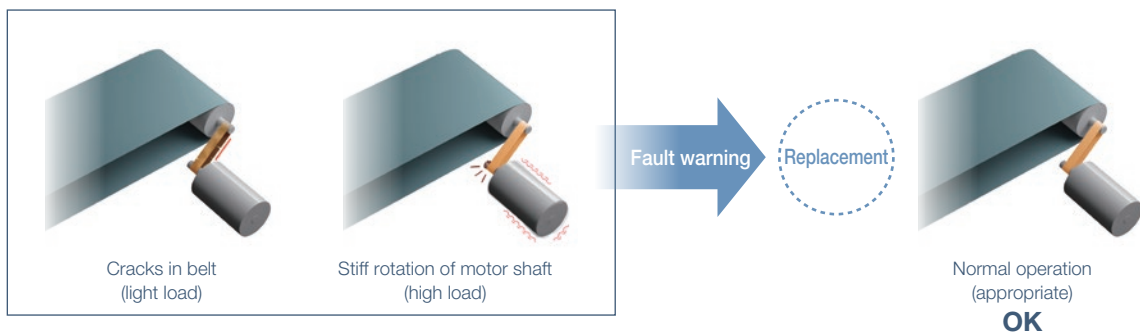

3 Supporting preventive maintenance of peripherals

E800

E800-E

E800-SCE

► Maintenance timer

The Maintenance timer signal is output when the inverter's cumulative energization time reaches the time period set with the parameter. This can be used as a guide for when the maintenance of the equipment should be conducted.

4 Thorough customer support

E800

E800-E

E800-SCE

► FA Center network

Our global network offers reliable technical support and customer satisfaction. (Refer to page 42.)

► Setup information web page

Our setup information web page provides easy access to manuals, videos, and outline dimension drawings (Refer to page 27.)





Maintenance

Downtime reduction

When a fault occurs, AI analysis and other diagnosis functions solve the problem quickly.



1 Streamlining the installation process

► **Compatible installation size**

E800

E800-E

E800-SCE

The installation size was determined to assure exchangeability with the FR-E700 series. Installation interchange attachment options are available for facilitating replacement with the models of different size (FR-E820-3.7K, FR-E840-0.4K/0.75K/1.5K).

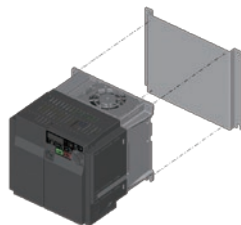

2 Quick reaction to troubles

► **Power supply from USB port**

E800

E800-E

E800-SCE

With the power supplied from the computer (USB bus power connection)*1, parameters can be set while the main circuit power supply is OFF.

Maintenance can be performed quickly and safely.

*1: The maximum SCCR should be 500 mA. A PU connector cannot be used during USB bus power connection.



3 Easy and fast wiring

► **Spring clamp terminals**

- Spring clamp terminals have been adopted for control circuit terminals for easy wiring. Furthermore, wires can be protected against loosening or contact faults due to vibrations during operation on a bogie or during transport. No additional screw tightening is required.

		FR-E800	FR-E800-E	FR-E800-SCE
Input terminal		7	2	0
Output terminal	Open collector	2	0	0
	Relay	1	1	1

E800

E800-E

E800-SCE

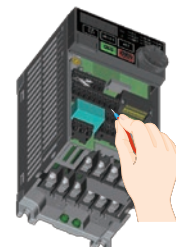

4 Troubleshooting supported by AI technology

E800

E800-E

E800-SCE

▶ AI fault diagnosis

The inverter is connected to the engineering software, FR Configurator2, in which Maisart*1 (Mitsubishi Electric's AI technology) is integrated to analyze data and help identify the cause of a fault.

This function enables the fastest troubleshooting procedure without requiring any special skills, which contributes to downtime reduction.



Maisart

*1: Maisart is Mitsubishi Electric's brand of AI technology. The name stands for "Mitsubishi Electric's AI creates the State-of-the-ART in technology". This means that it is using our proprietary AI technology to make everything smarter.

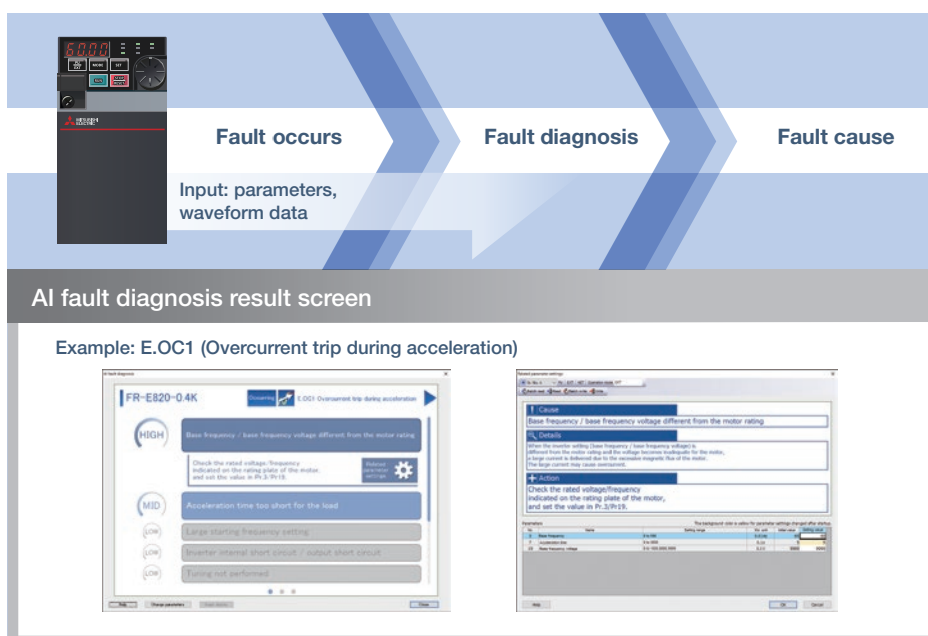

5 Trouble analysis from a remote location

E800

E800-E

E800-SCE

▶ Trace function

The operating status (output frequency or other data) immediately before the protective function is activated can be stored in a data file.

Users can read the data file in FR Configurator2 for graph display or send it by e-mail to someone away from the worksite, which facilitates the trouble analysis.

▶ Clock function

Setting the time*1 enables the user to specify the protective function activation time.

The date and time are also saved with the trace data, making the fault analysis easier.

*1: The clock is reset at power-OFF.

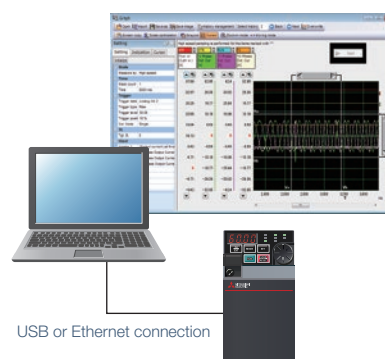



Engineering software for further ease of operation

The work efficiency can be improved for each of the design, operation, and maintenance processes.

1 FR Configurator2 for further ease of operation

Using FR Configurator2, easy-to-use software assisting anything from setup to maintenance, much more useful functions are available for users.

E800 E800-E E800-SCE

Free trial version Functions

The function with the marking above is available in the free trial version (usable free of charge with limited functions). It can be downloaded at Mitsubishi Electric FA Global Website.

Function	Free trial version	Function	Free trial version
Parameter list	○	Convert	○
Diagnosis	○	Developer	×
AI fault diagnosis	×	USB memory parameter copy file edit	×
Graph	×	Ethernet parameter setting	○
Batch monitor	×	iQSS backup file conversion	○
Test operation	○	Help	○
I/O terminal monitor	×		

A full functional trial version, which has the same functionality as the release version, is also offered for a limited period of 20 days. ○: Supported ×: Not supported

Life diagnosis check Free trial version Functions

Parts service life data is displayed in a dedicated window. A warning icon is shown in the alarm field of the parts recommended for replacement.

This can be used as a guideline to replace long life parts.



Graph function—Automatic sampling when a fault occurs

Waveform graph data immediately before the protective function is activated can be automatically obtained.

Graph display and log analysis are available using the stored trace data.



Ethernet parameter setting Free trial version Functions

Inverters in the same subnet mask are automatically detected, supporting easy network setting.

1) Detect supported devices.



2) Enter the network No., station No., IP address, and subnet mask.

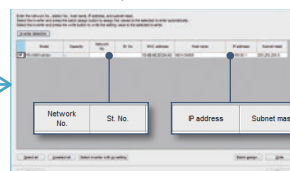

Setting complete

Diagnostics (Fault history)

Fault records in the inverter can be displayed. When the clock function or CC-Link IE TSN communication is used, the time of fault occurrence can be displayed, too. It is possible to check the occurrence time and the type of faults, which is helpful in identifying causes of faults.

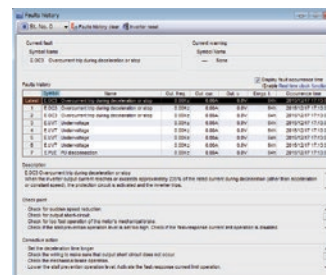

2 Further facilitating operation with your smartphone

E800

E800-E

E800-SCE

▶ Setup information web page

Users can scan the QR code on the product to directly access the setup information. Manuals, videos, and outline dimension drawings are available. (FR-E800 series inverters)

▶ Mobile app

To be supported soon

E800

E800-E

E800-SCE

Wireless access with inverters from a remote location enables setting or changing of parameters, starting and stopping, and monitoring on the screen of mobile devices.

Users can easily monitor the inverter operation by checking data such as the running frequency and status of input and output terminals at a glance in one screen.

Wireless communication equipment must be prepared in the system that includes the inverter.

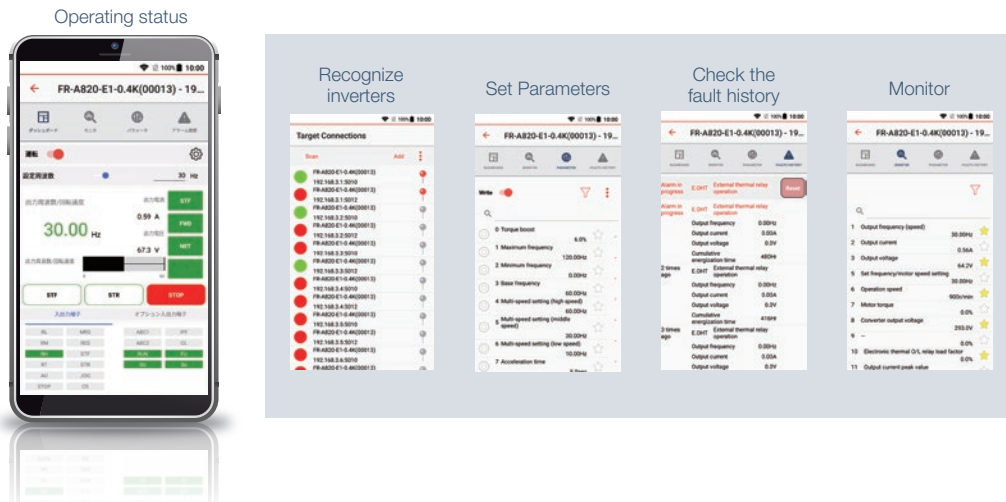



Engineering tools

Engineering software for further ease of operation

The work efficiency can be improved for each of the design, operation, and maintenance processes.

3 Further facilitating operation with the capacity selection software To be supported soon

E800 **E800-E** **E800-SCE**

Users can select motors by entering data of mechanical configuration, specifications, and operating patterns. Applicable combinations include inverters, sensorless servo drive units, and AC servo amplifiers. The most suitable combination can be selected from the selection result. The software also supports multi-axis systems. Twelve types of load mechanism such as a ball screw or a rack and pinion are selectable. Selection is available by following the steps from 1 to 3. When users include the power regeneration common converter or other applicable converter, the capacity of the converter can be selected at the same time.

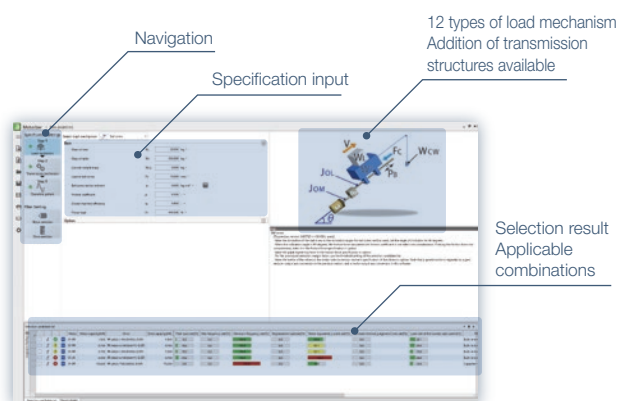

4 Further facilitating operation with the selection guide software To be supported soon

E800 **E800-E** **E800-SCE**

Advanced search for optimum inverters is available. Users can select inverters by entering data such as the motor capacity and current value and specifying specifications. The time spent on inverter selection can be reduced.

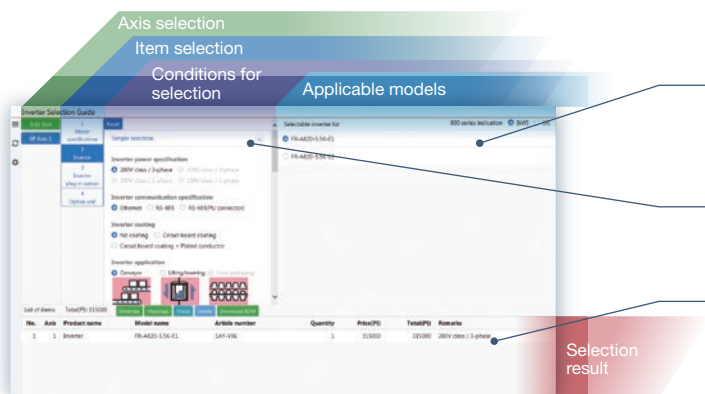

Applicable models will change in real time according to changes made to entries. Users do not have to fill all fields for selection. Applicable models will be selected according to the data entered.

Users can select the items to enter to set conditions for selection by folding or unfolding windows. Both easy setting and detailed setting are available.

Users can select one of the applicable models to register it as the selection result.

5 Further facilitating operation with Edgexcross

E800 **E800-E** **E800-SCE**

Inverters and the system are integrated by maximizing the use of production data with edge computing, enabling solutions for various issues including productivity improvement and equipment maintenance.

- Integration and processing of data sent from various devices and systems in production lines
- Real-time feedback to production sites
- Monitoring of field devices based on the know-how of production sites

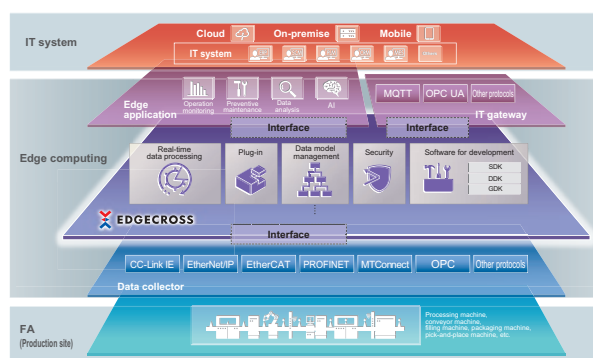

6 Further facilitating operation with GOT interaction functions To be supported soon

E800

E800-E

E800-SCE

GOT Drive

Enhanced compatibility between inverters and the GOT (human machine interface) brings various benefits to users.

Connection with the GOT2000 series can be established just by setting the station number. Other necessary settings are automatically done.

▶ Less time spent on screen design work by importing sample screens

Various sample screens*1 are available to enable parameter setting, batch monitor, measurement of load characteristics and so on using the GOT.

Using sample screens enables easy startup of the system.

*1: Sample screens are included in the GT Works3 (Ver. 1.205P or later) package, or can be downloaded at Mitsubishi Electric FA Global Website.

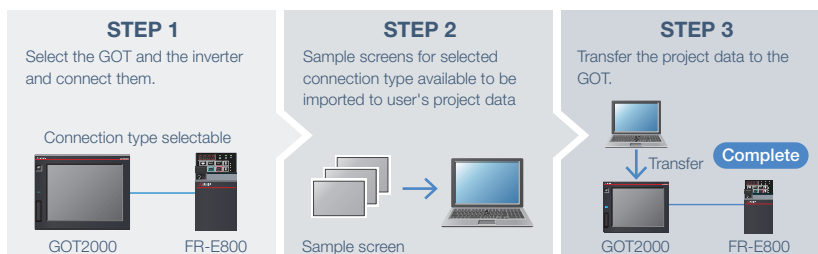

▶ Improving work efficiency without using a computer

Users can use the GOT to set up, adjust, and perform maintenance for inverters without using a computer.



▶ Immediate warning of system errors

By storing the data of relationship between the output frequency and the torque during normal inverter operation, users can judge whether the load is operating in normal condition. By outputting out-of-range warnings if applicable, users can detect mechanical faults or perform maintenance.

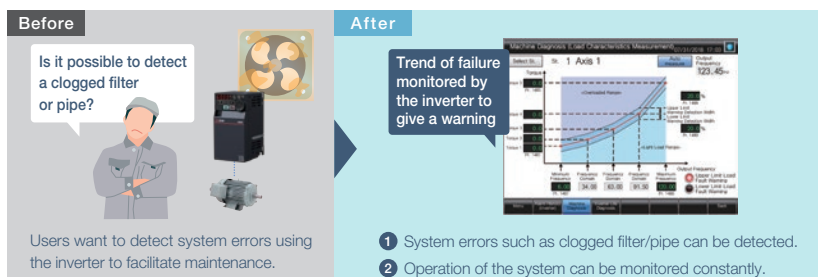

▶ Reducing downtime by interacting with the GOT

Faults occurred in the inverter can be displayed on the GOT screen. When a fault occurs, it is possible to identify the cause immediately, which contributes to downtime reduction.

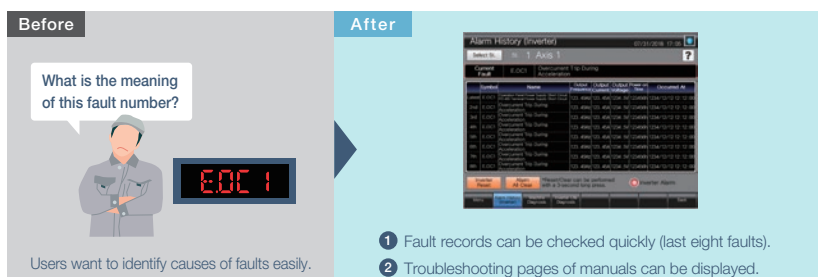

Lineup

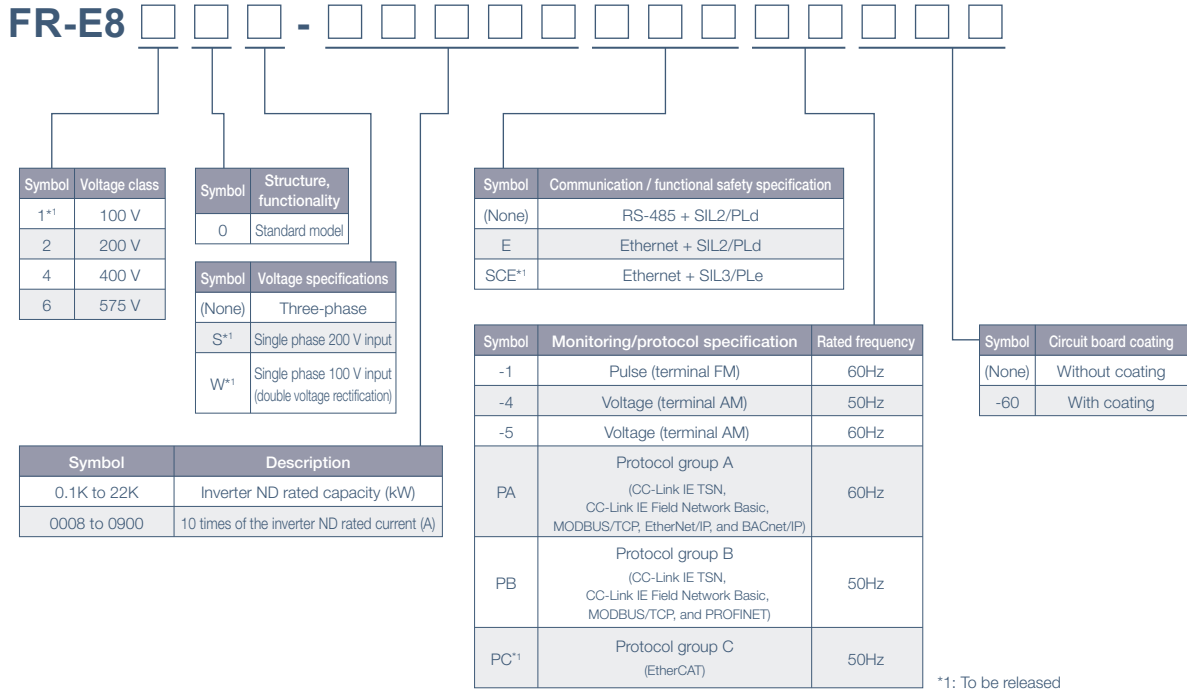

Model		Applicable motor capacity (ND rating) (kW)												
		0.1	0.2	0.4	0.75	1.5	2.2	3.7	5.5	7.5	11	15	18.5	22
Three-phase 200 V	FR-E820-[]K(E)	●	●	●	●	●	●	●	●	●	○	○	○	○
	FR-E820-[]KSCE	○	○	○	○	○	○	○	○	○	○	○	○	○
Three-phase 400 V	FR-E840-[]K(E)	—	—	●	●	●	●	●	●	●	○	○	○	○
	FR-E840-[]KSCE	—	—	○	○	○	○	○	○	○	○	○	○	○
Three-phase 575 V	FR-E860-[]K(E)	—	—	—	●	●	●	●	●	●	—	—	—	—
	FR-E860-[]KSCE	—	—	—	○	○	○	○	○	○	—	—	—	—
Single-phase 200 V	FR-E820S-[]K(E/SCE)	○	○	○	○	○	○	—	—	—	—	—	—	—
Single-phase 100 V	FR-E810W-[]K(E/SCE)	○	○	○	○	—	—	—	—	—	—	—	—	—

●: Released, ○: To be released, —: Not applicable



Rating

◆ Three-phase 200 V power supply

Model FR-E820-□		0.1K	0.2K	0.4K	0.75K	1.5K	2.2K	3.7K	5.5K	7.5K		
		0008	0015	0030	0050	0080	0110	0175	0240	0330		
Output	Applicable motor capacity (kW)*1	LD	0.2	0.4	0.75	1.1	2.2	3.0	5.5	7.5	11	
		ND	0.1	0.2	0.4	0.75	1.5	2.2	3.7	5.5	7.5	
	Rated capacity (kVA)*2	LD	0.5	0.8	1.4	2.4	3.8	4.8	7.8	12.0	15.9	
		ND	0.3	0.6	1.2	2.0	3.2	4.4	7.0	9.6	13.1	
	Rated current (A)*7	LD	1.3 (1.1)	2 (1.7)	3.5 (3.0)	6.0 (5.1)	9.6 (8.2)	12 (10.2)	19.6 (16.7)	30 (25.5)	40 (34)	
		ND	0.8 (0.8)	1.5 (1.4)	3 (2.5)	5 (4.1)	8 (7)	11 (10)	17.5 (16.5)	24 (23)	33 (31)	
	Overload current rating*3	LD	120% 60 s, 150% 3 s (inverse-time characteristics) at surrounding air temperature of 50°C									
		ND	150% 60 s, 200% 3 s (inverse-time characteristics) at surrounding air temperature of 50°C									
	Rated voltage*4		Three-phase 200 to 240 V									
	Regenerative braking	Brake transistor	-									
Maximum brake torque*5		150%				100%		50%		20%		
Rated input AC voltage/frequency		Three-phase 200 to 240 V 50 Hz / 60 Hz										
Permissible AC voltage fluctuation		170 to 264 V 50 Hz / 60 Hz										
Permissible frequency fluctuation		±5%										
Power supply	Rated input current (A)*8	LD	Without DC reactor	1.9	3.0	5.1	8.2	13	16	26	37	49
		With DC reactor	1.3	2.0	3.5	6.0	9.6	12	20	30	40	
	ND	Without DC reactor	1.4	2.3	4.5	7.0	11	15	23	30	41	
		With DC reactor	0.8	1.5	3.0	5.0	8.0	11	17.5	24	33	
	Power supply capacity (kVA)*6	LD	Without DC reactor	0.7	1.1	1.9	3.1	4.8	6.2	9.7	14	19
		With DC reactor	0.5	0.8	1.3	2.3	3.7	4.6	7.5	11	15	
ND	Without DC reactor	0.5	0.9	1.7	2.7	4.1	5.7	8.8	12	16		
With DC reactor	0.3	0.6	1.1	1.9	3.0	4.2	6.7	9.1	13			
Protective structure (IEC 60529)		Enclosed type (IP20)										
Cooling system		Natural					Forced air					
Approximate mass (kg)		0.5	0.5	0.7	1.0	1.4	1.4	1.8	3.3	3.3		

◆ Three-phase 400 V class

Model FR-E840-□		0.4K	0.75K	1.5K	2.2K	3.7K	5.5K	7.5K		
		0016	0026	0040	0060	0095	0120	0170		
Output	Applicable motor capacity (kW)*1	LD	0.75	1.5	2.2	3.0	5.5	7.5	11	
	ND	0.4	0.75	1.5	2.2	3.7	5.5	7.5		
Rated capacity (kVA)*2	LD	1.6	2.7	4.2	5.3	8.5	13.3	17.5		
	ND	1.2	2.0	3.0	4.6	7.2	9.1	13.0		
Rated current (A)*7	LD	2.1 (1.8)	3.5 (3.0)	5.5 (4.7)	6.9 (5.9)	11.1 (9.4)	17.5 (14.9)	23 (19.6)		
	ND	1.6 (1.4)	2.6 (2.2)	8 (7)	11 (10)	17.5 (16.5)	24 (23)	33 (31)		
Overload current rating*3	LD	120% 60 s, 150% 3 s (inverse-time characteristics) at surrounding air temperature of 50°C								
	ND	150% 60 s, 200% 3 s (inverse-time characteristics) at surrounding air temperature of 50°C								
Rated voltage*4		Three-phase 380 to 480 V								
Regenerative braking	Brake transistor	Built-in								
	Maximum brake torque*5	100%			50%		20%			
Rated input AC voltage/frequency		Three-phase 380 to 480 V 50 Hz / 60 Hz								
Permissible AC voltage fluctuation		323 to 528 V 50 Hz / 60 Hz								
Permissible frequency fluctuation		±5%								
Power supply	Rated input current (A)*8	LD	Without DC reactor	3.3	6.0	8.9	11	16	25	32
		With DC reactor	2.1	3.5	5.5	6.9	11	18	23	
	ND	Without DC reactor	2.7	4.4	6.7	9.5	14	18	25	
		With DC reactor	1.6	2.6	4.0	6.0	9.5	12	17	
	Power supply capacity (kVA)*6	LD	Without DC reactor	2.5	4.5	6.8	8.2	12	19	25
		With DC reactor	1.6	2.7	4.2	5.3	8.5	13	18	
ND	Without DC reactor	2.1	3.4	5.1	7.2	11	14	19		
With DC reactor	1.2	2.0	3.0	4.6	7.2	9.1	13			
Protective structure (IEC 60529)		Enclosed type (IP20)								
Cooling system		Natural				Forced air				
Approximate mass (kg)		1.2	1.2	1.4	1.8	1.8	2.4	2.4		

- *1 The applicable motor capacity indicated is the maximum capacity applicable for use of the Mitsubishi Electric 4-pole standard efficiency motor.
- *2 The rated output capacity indicated assumes that the output voltage is 230 V for three-phase 200 V class and 440 V for three-phase 400 V class.
- *3 The % value of the overload current rating indicated is the ratio of the overload current to the inverter's rated output current. For repeated duty, allow time for the inverter and motor to return to or below the temperatures under 100% load.
- *4 The maximum output voltage does not exceed the power supply voltage. The maximum output voltage can be changed within the setting range. However, the pulse voltage value of the inverter output side voltage remains unchanged at about $\sqrt{2}$ that of the power supply.
- *5 The braking torque indicated is a short-duration average torque (which varies with motor loss) when the motor alone is decelerated from 60 Hz in the shortest time and is not a continuous regenerative torque. When the motor is decelerated from the frequency higher than the base frequency, the average deceleration torque will reduce. Since the inverter does not contain a brake resistor, use the optional brake resistor when regenerative energy is large. A brake unit (FR-BU2) may also be used. (Option brake resistor cannot be used for 0.1K and 0.2K.)
- *6 The power supply capacity varies with the value of the power supply side inverter impedance (including those of the input reactor and cables).
- *7 Setting 2 kHz or more in **Pr. 72 PWM frequency selection** to perform low acoustic noise operation in the surrounding air temperature exceeding 40°C, the rated output current is the value in parenthesis.
- *8 The rated input current is the value when at the rated output current. The input power impedances (including those of the input reactor and cables) affect the value.

Rating

◆ Three-phase 575 V class

Model FR-E860-□			0.75K 0017	1.5K 0027	2.2K 0040	3.7K 0061	5.5K 0090	7.5K 0120	
Applicable motor capacity (kW)*1	LD		1.5	2.2	3.7	5.5	7.5	11	
	ND		0.75	1.5	2.2	3.7	5.5	7.5	
Rated capacity (kVA)*2	LD		2.5	3.6	5.6	8.2	11.0	15.9	
	ND		1.7	2.7	4.0	6.1	9.0	12.0	
Rated current (A)*7	LD		2.5 (2.1)	3.6 (3.0)	5.6 (4.8)	8.2 (7.0)	11 (9.0)	16 (13.6)	
	ND		1.7	2.7	4	6.1	9	12	
Overload current rating*3	LD		120% 60 s, 150% 3 s (inverse-time characteristics) at surrounding air temperature of 50°C						
	ND		150% 60 s, 200% 3 s (inverse-time characteristics) at surrounding air temperature of 50°C						
Rated voltage*4			Three-phase 525 to 600 V						
Regenerative braking	Brake transistor		Built-in						
	Maximum brake torque*5		100%	50%	20%				
Rated input AC voltage/frequency			Three-phase 575 V 60 Hz						
Permissible AC voltage fluctuation			490 to 632 V 60 Hz						
Permissible frequency fluctuation			±5%						
Power supply	Rated input current (A)*8	LD	Without DC reactor	4.3	5.9	8.9	12	16	22
			With DC reactor	2.5	3.6	5.6	8.2	11	16
		ND	Without DC reactor	3.0	4.6	6.6	10	13	17
			With DC reactor	1.7	2.7	4.0	6.1	9.0	12
	Power supply capacity (kVA)*6	LD	Without DC reactor	4.3	5.9	8.9	12	16	22
			With DC reactor	2.5	3.6	5.6	8.2	11	16
		ND	Without DC reactor	3.0	4.6	6.6	9.5	13	17
			With DC reactor	1.7	2.7	4.0	6.1	9.0	12
Protective structure (IEC 60529)			Enclosed type (IP20)						
Cooling system			Natural Forced air						
Approximate mass (kg)			1.9	1.9	1.9	2.4	2.4	2.4	

- *1 The applicable motor capacity indicated is the maximum capacity applicable for use of the Mitsubishi Electric 4-pole standard efficiency motor.
- *2 The rated output capacity indicated assumes that the output voltage is 575 V.
- *3 The % value of the overload current rating indicated is the ratio of the overload current to the inverter's rated output current. For repeated duty, allow time for the inverter and motor to return to or below the temperatures under 100% load.
- *4 The maximum output voltage does not exceed the power supply voltage. The maximum output voltage can be changed within the setting range. However, the pulse voltage value of the inverter output side voltage remains unchanged at about 1/2 that of the power supply.
- *5 The braking torque indicated is a short-duration average torque (which varies with motor loss) when the motor alone is decelerated from 60 Hz in the shortest time and is not a continuous regenerative torque. When the motor is decelerated from the frequency higher than the base frequency, the average deceleration torque will reduce. Since the inverter does not contain a brake resistor, use the optional brake resistor when regenerative energy is large. A brake unit (FR-BU2) may also be used. (Option brake resistor cannot be used for 0.1K and 0.2K.)
- *6 The power supply capacity varies with the value of the power supply side inverter impedance (including those of the input reactor and cables).
- *7 Setting 2 kHz or more in **Pr. 72 PWM frequency selection** to perform low acoustic noise operation in the surrounding air temperature exceeding 40°C, the rated output current is the value in parenthesis.
- *8 The rated input current indicates a value at a rated output voltage. The impedance at the power supply side (including those of the input reactor and cables) affects the rated input current.

MEMO

Common specifications

Control specifications	Control method		Soft-PWM control/high carrier frequency PWM control	
		Induction motor	V/F control, Advanced magnetic flux vector control, Real sensorless vector control	
		PM motor	PM sensorless vector control	
	Output frequency range	Induction motor	0.2 to 590 Hz (The upper-limit frequency is 400 Hz under Advanced magnetic flux vector control, and Real sensorless vector control.)	
		PM motor	0.2 to 400 Hz (not operable at maximum motor frequency or higher)	
	Frequency setting resolution	Analog input	0.015 Hz / 0 to 60 Hz (terminal 2, 4: 0 to 10 V / 12 bits)	
		Digital input	0.03 Hz / 0 to 60 Hz (terminal 2, 4: 0 to 5 V / 11 bits, 0 to 20 mA / 11 bits)	
	Frequency accuracy	Analog input	Within $\pm 0.2\%$ of the max. output frequency (25°C $\pm 10^\circ\text{C}$)	
		Digital input	Within 0.01% of the set output frequency	
	Voltage/frequency characteristics			Base frequency can be set from 0 to 590 Hz. Constant-torque/variable torque pattern can be selected. (available with induction motors only)
	Starting torque	Induction motor	150% 0.5 Hz (Advanced magnetic flux vector control) 200% 0.3 Hz (0.4K to 3.7K), 150% 0.3 Hz (5.5K or more) (Real sensorless vector control)	
		PM motor	50%	
	Torque boost			Manual torque boost (available with induction motors only)
	Acceleration/deceleration time setting			0 to 3600 s (acceleration and deceleration can be set individually), linear or S-pattern acceleration/deceleration mode
DC injection brake	Induction motor	Operation frequency (0 to 120 Hz), operation time (0 to 10 s), operation voltage (0 to 30%) can be changed.		
	PM motor	Operation time (0 to 10 s) can be changed, operation voltage (operating current) is fixed.		
Stall prevention operation level			Operation current level can be set (0 to 220% adjustable), whether to use the function or not can be selected.	
Torque limit level			Torque limit value can be set (0 to 400% variable).	
Operation specifications	Frequency setting signal	Analog input	Terminals 2 and 4: 0 to 10 V, 0 to 5 V, 4 to 20 mA (0 to 20 mA) are available.	
		Digital input	Input using the setting dial of the operation panel*1 Four-digit BCD or 16-bit binary (when used with option FR-A8AX E kit)	
	Start signal			Forward and reverse rotation or start signal automatic self-holding input (3-wire input) can be selected.
	Input signal (Seven terminals/Two terminals)			Low-speed operation command, Middle-speed operation command, High-speed operation command, Output stop, Forward rotation command, Reverse rotation command, Inverter reset The input signal can be changed using Pr.178 to Pr.189 (input terminal function selection) .
	Operational functions			Maximum and minimum frequency settings, multi-speed operation, acceleration/deceleration pattern, thermal protection, DC injection brake, starting frequency, JOG operation, output stop (MRS), stall prevention, regeneration avoidance, frequency jump, rotation display, automatic restart after instantaneous power failure, remote setting, automatic acceleration/deceleration, retry function, carrier frequency selection, fast-response current limit, forward/reverse rotation prevention, operation mode selection, slip compensation, droop control, speed smoothing control, traverse, auto tuning, applied motor selection, RS-485 communication*1, Ethernet communication*2, PID control, easy dancer control, cooling fan operation selection, stop selection (deceleration stop/coasting), power-failure deceleration stop function, stop-on-contact control, PLC function, life diagnosis, maintenance timer, current average monitor, multiple rating, speed control, torque control, torque limit, safety stop function
	Output signal	Open collector output (Two terminals) Relay output (One terminal)		Inverter running, Up to frequency The output signal can be changed using Pr.190 to Pr.196 (output terminal function selection). Fault codes of the inverter can be output (4 bits) from the open collector.
		Analog output (AM type)		-10 to +10 V / 12 bits
Protective/warning function	Protective functions		Overcurrent trip during acceleration, Overcurrent trip during constant speed, Overcurrent trip during deceleration or stop, Regenerative overvoltage trip during acceleration, Regenerative overvoltage trip during constant speed, Regenerative overvoltage trip during deceleration or stop, Inverter overload trip, Motor overload trip, Heat sink overheat, Undervoltage, Input phase loss, Stall prevention stop, Loss of synchronism detection*3, Upper limit fault detection, Lower limit fault detection, Brake transistor alarm detection, Output side earth (ground) fault overcurrent, Output short circuit, Output phase loss, External thermal relay operation, Option fault, Communication option fault, Parameter storage device fault, PU disconnection, Retry count excess, CPU fault, OC detect level, inrush resistance overheat, Communication fault (inverter), USB communication fault, analog input error, Safety circuit fault, Overspeed occurrence*3, Speed deviation excess detection*3, Brake sequence fault*3, PID signal fault, Ethernet communication fault*2, Opposite rotation deceleration fault*3, Internal circuit fault	
	Warning functions		Fan alarm, Stall prevention (overcurrent), Stall prevention (overvoltage), Regenerative brake pre-alarm*3, Electronic thermal relay function pre-alarm, PU stop, Maintenance timer warning, Parameter write error, Operation panel lock*3, Speed limit indication, Safety stop, Ethernet communication fault*2, Duplicate IP address*2, IP address fault*2	
Environment	Surrounding air temperature		-20°C to +60°C (The rated current must be reduced at a temperature above 50°C.)	
	Ambient humidity		95% RH or less (non-condensing) (With circuit board coating) 90% RH or less (non-condensing) (Without circuit board coating)	
	Storage temperature*4		-40°C to +70°C	
	Atmosphere		Indoors (without corrosive gas, flammable gas, oil mist, dust and dirt, etc.)	
	Altitude/vibration*5		Maximum 3000 m (Maximum 2000 m for the 575 V class), 5.9 m/s ² or less at 10 to 55 Hz (directions of X, Y, Z axes)	

*1 Enabled only for standard models.

*2 Enabled only for Ethernet models.

*3 This protective function is not available in the initial status.

*4 Temperature applicable for a short time, e.g. in transit.

*5 For the installation at an altitude above 1000 m, consider a 3% reduction in the rated current per 500 m increase in altitude.

Outline Dimension Drawings

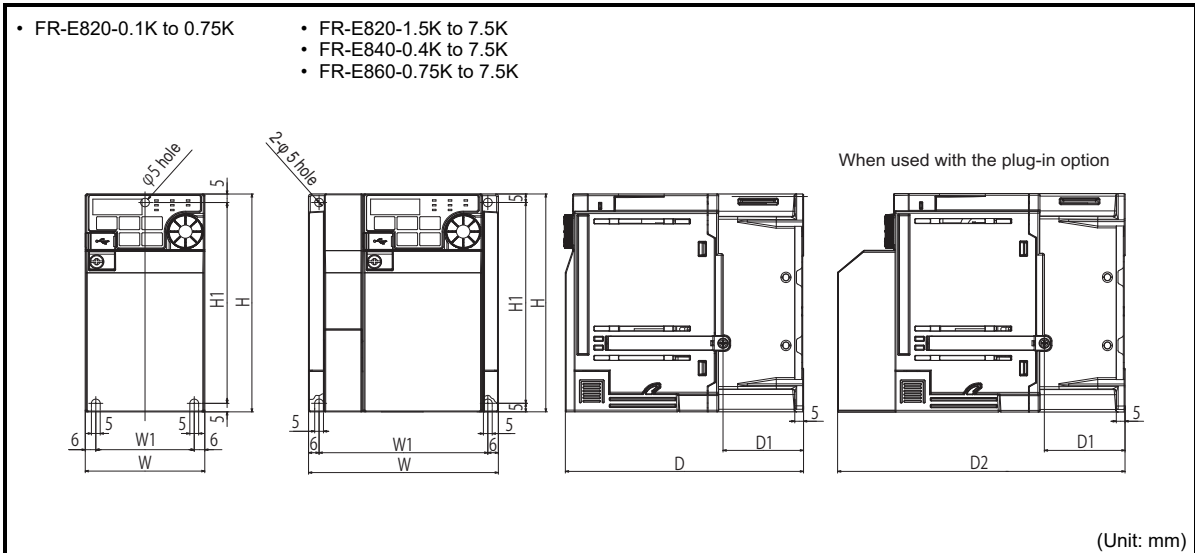

• Three-phase 200 V class

Inverter model	W	W1	H	H1	D	D1	D2
FR-E820-0.1K	68	56	128	118	80.5	10	108.1
FR-E820-0.2K					112.5	42	140.1
FR-E820-0.4K					132.5		160.1
FR-E820-0.75K	108	96			135.5	46	163.1
FR-E820-1.5K	140	128			142.5	52.5	170.1
FR-E820-2.2K							
FR-E820-3.7K	180	164	260	244	165	71.5	192.6
FR-E820-5.5K							
FR-E820-7.5K							

• Three-phase 400 V class

Inverter model	W	W1	H	H1	D	D1	D2
FR-E840-0.4K	108	96	128	118	129.5	40	157.1
FR-E840-0.75K						46	
FR-E840-1.5K	140	128	150	138	135	43.5	163.1
FR-E840-2.2K							
FR-E840-3.7K	220	208	150	138	147	68	174.6
FR-E840-5.5K							
FR-E840-7.5K							

• Three-phase 575 V class

Inverter model	W	W1	H	H1	D	D1	D2
FR-E860-0.75K	140	128	150	138	135	43.5	163.1
FR-E860-1.5K							
FR-E860-2.2K							
FR-E860-3.7K	220	208			147	68	174.6
FR-E860-5.5K							
FR-E860-7.5K							

Terminal Connection Diagram

E800

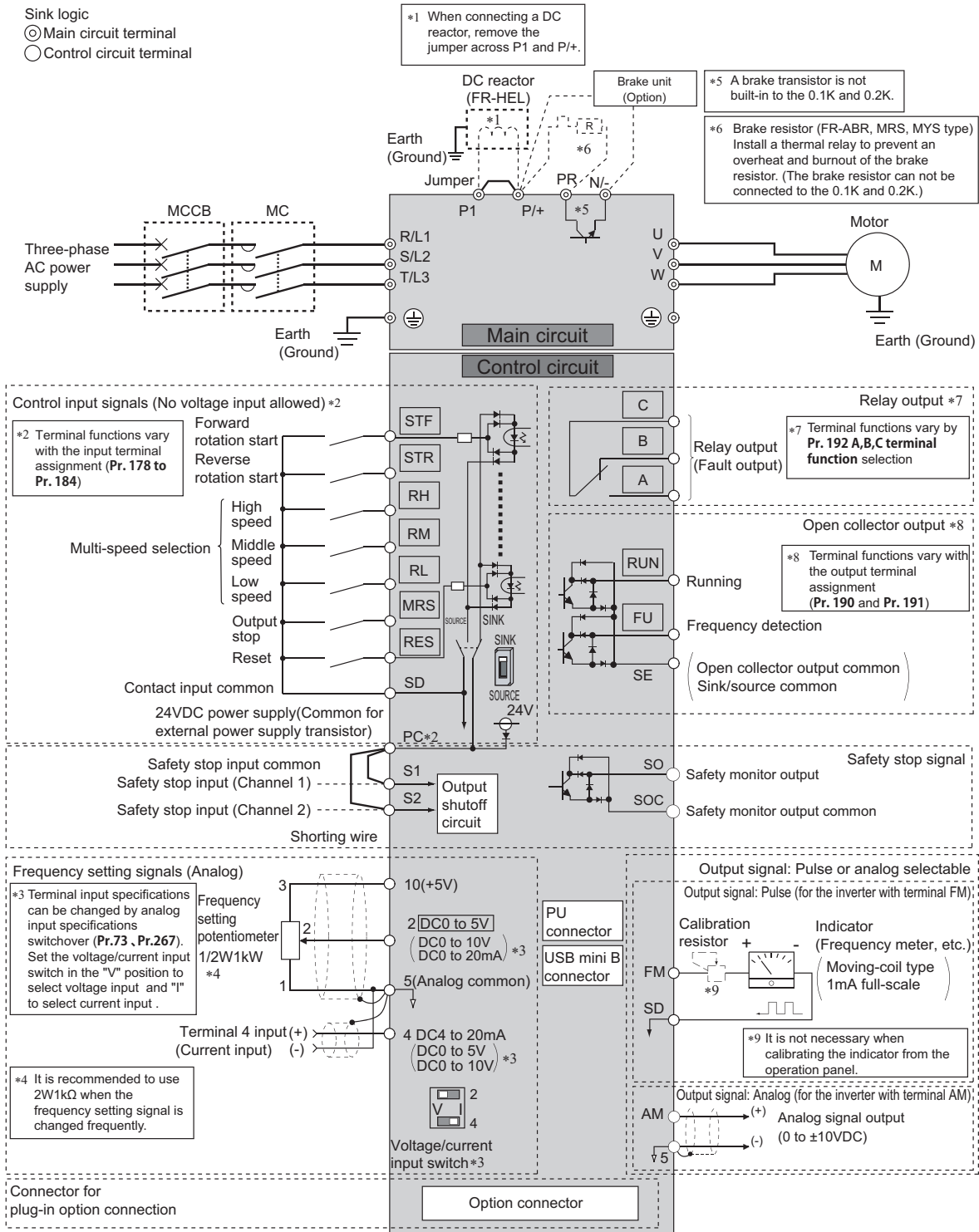

Terminal Specifications

E800

Type	Terminal Symbol	Terminal Name	Description			
Main circuit	R/L1, S/L2, T/L3	AC power input	Connect to the commercial power supply. Do not connect anything to these terminals when using the high power factor converter (FR-HC2) or the multifunction regeneration converter (FR-XC) in common bus regeneration mode.			
	U, V, W	Inverter output	Connect a three-phase squirrel-cage motor or PM motor.			
	P/+, PR	Brake resistor connection	Connect a brake transistor (MRS type, MYS type, FR-ABR) across terminals P/+ - PR. (The brake resistor cannot be connected to the 0.1K or 0.2K)			
	P/+, N/-	Brake unit connection	Connect the brake unit (FR-BU2), multifunction regeneration converter (FR-XC), or high power factor converter (FR-HC2).			
	P/+, P1	DC reactor connection	Remove the jumper across terminals P/+ - P1 and connect a DC reactor. When a DC reactor is not connected, the jumper across terminals P/+ and P1 should not be removed.			
		Earth (Ground)	For earthing (grounding) the inverter chassis. Must be earthed (grounded).			
input signal	Contact input	STF*1	Forward rotation start	Turn on the STF signal to start forward rotation and turn it off to stop.	When the STF and STR signals are turned on simultaneously, the stop command is given.	
		STR*1	Reverse rotation start	Turn on the STR signal to start reverse rotation and turn it off to stop.		
		RH, RM, RL*1	Multi-speed selection	Multi-speed can be selected according to the combination of RH, RM and RL signals.		Input resistance: 4.7 kΩ, voltage when contacts are open: 21 to 26 VDC, current when contacts are short-circuited: 4 to 6 mADC
		MRS*1	Output stop	Turn on the MRS signal (20ms or more) to stop the inverter output. Use to shut off the inverter output when stopping the motor by electromagnetic brake.		
		RES*1	Reset	Use to reset alarm output provided when protective circuit is activated. Turn on the RES signal for more than 0.1s, then turn it off. It is possible to set the initial setting to "always enabled". By setting Pr. 75, reset can be set enabled only at fault occurrence. Recover about 1s after reset is cancelled.		
		SD	Contact input common (sink) (initial setting)	Common terminal for contact input terminal (sink logic) and terminal FM.		
	External transistor common (source)		Connect this terminal to the power supply common terminal of a transistor output (open collector output) device, such as a programmable controller, in the source logic to avoid malfunction by undesirable currents.			
	24VDC power supply common		Common output terminal for 24VDC 0.1A power supply (PC terminal). Isolated from terminals 5 and SE.			
	PC	External transistor common (sink) (initial setting)	Connect this terminal to the power supply common terminal of a transistor output (open collector output) device, such as a programmable controller, in the sink logic to avoid malfunction by undesirable currents.			Power supply voltage range: 22.5 to 27 VDC, permissible load current: 100 mA
		Safety stop input terminal common	Common terminal for safety stop input terminals.			
		Contact input common (source)	Common terminal for contact input terminal (source logic).			
		24VDC power supply	Can be used as 24 VDC 0.1 A power supply.			
	Frequency setting	10	Frequency setting power supply	Used as power supply when connecting potentiometer for frequency setting (speed setting) from outside of the inverter.		5 VDC ± 0.5 V permissible load current 10 mA
		2	Frequency setting (voltage)	Inputting 0 to 5 VDC (or 0 to 10 VDC) provides the maximum output frequency at 5 V (or 10 V) and makes input and output proportional. Use Pr.73 to switch between input 0 to 5 VDC (initial setting) and 0 to 10 VDC input. Set the voltage/current input switch to the "I" position to select current input (0 to 20 mA).		Voltage input: Input resistance 10 kΩ ± 1 kΩ Permissible maximum voltage 20 VDC Current input: Input resistance 245 Ω ± 5 Ω Maximum permissible current 30 mA.
		4	Frequency setting (current)	Inputting 4 to 20 mADC (or 0 to 5 VDC, 0 to 10 VDC) provides the maximum output frequency at 20 mA and makes input and output proportional. This input signal is valid only when the AU signal is ON (terminal 2 input is invalid). To use the terminal 4 (current input at initial setting), assign "4" to any parameter from Pr.178 to Pr.184 (Input terminal function selection) before turning ON the AU signal. Use Pr.267 to switch among input 4 to 20 mA (initial setting), 0 to 5 VDC, and 0 to 10 VDC. Set the voltage/current input switch in the "V" position to select voltage input (0 to 5 V / 0 to 10 V).		
5		Frequency setting common	Common terminal for the frequency setting signals (terminals 2 or 4). Do not earth (ground).			
output signal	Relay	A, B, C	Relay output (fault output)	1 changeover contact output indicates that the inverter fault occurs. Fault: discontinuity across B-C (continuity across A-C), Normal: continuity across B-C (discontinuity across A-C)	Contact capacity 240 VAC 2A (power factor = 0.4) 30 VDC 1A	
	Open collector	RUN	Inverter running	The output is in LOW state when the inverter output frequency is equal to or higher than the starting frequency (initial value: 0.5 Hz). The output is in HIGH state during stop or DC injection brake operation.*2	Permissible load 24 VDC (Maximum 27 VDC) 0.1 A (a voltage drop is 3.4 V maximum when the signal is on)	
		FU	Frequency detection	The output is in LOW state when the inverter output frequency is equal to or higher than the preset detection frequency, and is in HIGH state when it is less than the preset detection frequency.*2		
		SE	Open collector output common	Common terminal of terminal RUN and FU.		
	Pulse	FM*3	For meter	Select one e.g. output frequency from monitor items. (Not output during inverter reset.) The output signal is proportional to the magnitude of the corresponding monitoring item.	Output item: output frequency (initial setting)	Permissible load current 1 mA 1440 pulses/s at 60 Hz
		AM*3	Analog voltage output			Output signal 0 to ±10 VDC, permissible load current 1 mA (load impedance 10 kΩ or more), resolution 8 bit
Safety stop signal	S1	Safety stop input (Channel 1)	Terminals S1 and S2 are used for the safety stop input signal for the safety relay module. Terminals S1 and S2 are used at the same time (dual channel). Inverter output is shutdown by shortening/opening between terminals S1 and SIC, or between S2 and SIC. In the initial status, terminals S1 and S2 are shorted with terminal PC by shorting wires. Terminal SIC is shorted with terminal SD. Remove the shorting wires and connect the safety relay module when using the safety stop function.		Input resistance 4.7 kΩ Voltage when contacts are open 21 to 26 VDC Current when contacts are short-circuited 4 to 6 mADC	
	S2	Safety stop input (with 24 VDC input) (Channel 2)				
	SO	Safety monitor output (open collector output)	Indicates the safety stop input signal status. Switched to LOW when the status is other than the internal safety circuit failure. Refer to the FR-E800 Instruction Manual (Functional Safety) (BCN-A23488-000) when the signal is switched to HIGH while both terminals S1 and S2 are open. (Please contact your sales representative for the manual.)		Permissible load 24 VDC (maximum 27 VDC) 0.1 A (The voltage drop is 3.4 V at maximum while the signal is ON.)	
	SOC	Safety monitor output terminal common	Common terminal for terminal SO.			
Communication	—	PU connector	With the PU connector, RS-485 communication can be made. · Conforming standard: EIA-485 (RS-485) · Transmission format: Multi-drop link · Communication speed: 300 to 115200bps · Overall extension: 500m			
	—	USB connector*4	USB connection with a personal computer can be established. Setting, monitoring and testing of the inverter can be performed using FR Configurator2. · Interface: conforms to USB 1.1 · Transmission Speed: 12 Mbps · Connector: USB mini B connector (receptacle mini B type)			

*1 Terminal functions can be selected using Pr.178 to Pr.184 (Input terminal function selection).

*2 An open collector transistor is ON (conductive) in LOW state. The transistor is OFF (not conductive) in HIGH state.

*3 Terminal FM is provided for the FM type inverter. Terminal AM is provided for the AM type inverter.

*4 USB bus power connection is available. The maximum SCCR should be 500 mA. A PU connector cannot be used during USB bus power connection.

Terminal Connection Diagram

E800-E

Sink logic

- ⊙ Main circuit terminal
- Control circuit terminal

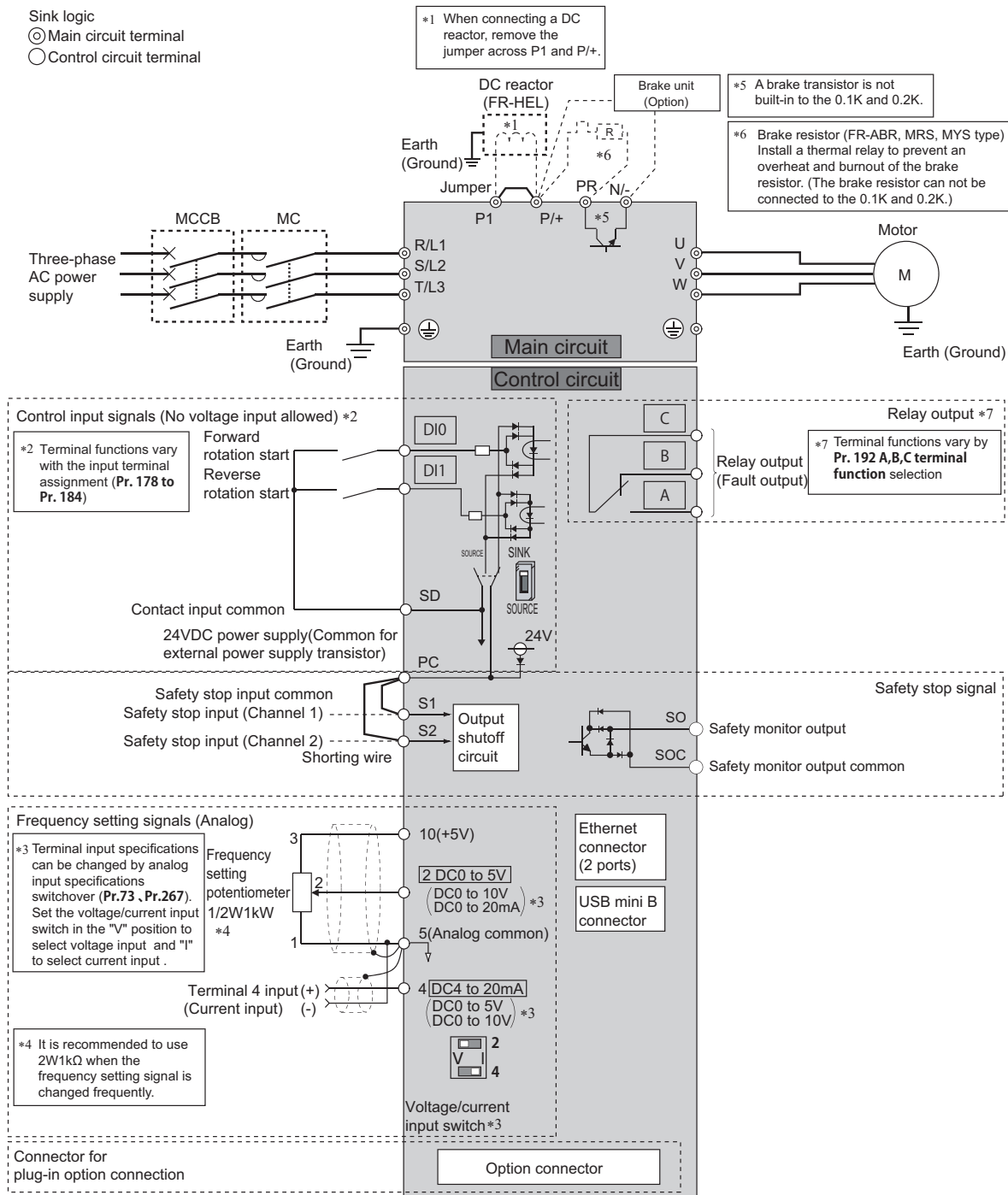

Terminal Specifications

E800-E

Type	Terminal Symbol	Terminal Name	Description			
Main circuit	R/L1, S/L2, T/L3	AC power input	Connect to the commercial power supply. Do not connect anything to these terminals when using the high power factor converter (FR-HC2) or the multifunction regeneration converter (FR-XC) in common bus regeneration mode.			
	U, V, W	Inverter output	Connect a three-phase squirrel-cage motor or PM motor.			
	P/+, PR	Brake resistor connection	Connect a brake transistor (MRS type, MYS type, FR-ABR) across terminals P/+ -PR. (The brake resistor cannot be connected to the 0.1K or 0.2K)			
	P/+, N/-	Brake unit connection	Connect the brake unit (FR-BU2), multifunction regeneration converter (FR-XC), or high power factor converter (FR-HC2).			
	P/+, P1	DC reactor connection	Remove the jumper across terminals P/+ -P1 and connect a DC reactor. When a DC reactor is not connected, the jumper across terminals P/+ and P1 should not be removed.			
		Earth (Ground)	For earthing (grounding) the inverter chassis. Must be earthed (grounded).			
input signal	DI0*1	Forward rotation start	Turn on the DI0 signal to start forward rotation and turn it off to stop.	When the DI0 and DI1 signals are turned on simultaneously, the stop command is given.	Input resistance: 4.7 kΩ, voltage when contacts are open: 21 to 26 VDC, current when contacts are short-circuited: 4 to 6 mADC	
		DI1*1	Reverse rotation start			Turn on the DI1 signal to start reverse rotation and turn it off to stop.
	SD	Contact input common (sink) (initial setting)	Common terminal for contact input terminal (sink logic).			
		External transistor common (source)	Connect this terminal to the power supply common terminal of a transistor output (open collector output) device, such as a programmable controller, in the source logic to avoid malfunction by undesirable current.			
		24 VDC power supply common	Common output terminal for 24 VDC 0.1 A power supply (PC terminal). Isolated from terminals 5 and SOC.			
		External transistor common (sink) (initial setting)	Connect this terminal to the power supply common terminal of a transistor output (open collector output) device, such as a programmable controller, in the sink logic to avoid malfunction by undesirable current.			
	PC	Safety stop input terminal common	Common terminal for safety stop input terminals.			Power supply voltage range: 22.5 to 27 VDC, permissible load current: 100 mA
		Contact input common (source)	Common terminal for the contact input terminal (source logic).			
		24 VDC power supply	Can be used as 24 VDC 0.1 A power supply.			
	Frequency setting	10	Frequency setting power supply	Used as power supply when connecting potentiometer for frequency setting (speed setting) from outside of the inverter.	5 VDC ± 0.5 V permissible load current 10 mA	
		2	Frequency setting (voltage)	Inputting 0 to 5 VDC (or 0 to 10 V) provides the maximum output frequency at 5 V (10 V) and makes input and output proportional. Use Pr. 73 to switch between input 0 to 5 VDC (initial setting) and 0 to 10 VDC input. Set the voltage/current input switch to the "I" position to select current input (0 to 20 mA).	Voltage input: Input resistance 10 kΩ ± 1 kΩ Permissible maximum voltage 20 VDC Current input: Input resistance 245 Ω ± 5 Ω Maximum permissible current 30 mA.	
		4	Frequency setting (current)	Inputting 0 to 20 mADC (or 0 to 5 V / 0 to 10 V) provides the maximum output frequency at 20 mA makes input and output proportional. This input signal is valid only when the AU signal is on (terminal 2 input is invalid). To use terminal 4 (initial setting is current input), set "4" to any of Pr.178, Pr.179 (input terminal function selection), and turn AU signal ON. Use Pr. 267 to switch from among input 4 to 20 mA (initial setting), 0 to 5 VDC and 0 to 10 VDC. Set the voltage/current input switch in the "V" position to select voltage input (0 to 5 V / 0 to 10 V).		
		5	Frequency setting common	Common terminal for the frequency setting signals (terminals 2 or 4). Do not earth (ground).		
		Relay	A, B, C	Relay output (fault output)	1 changeover contact output indicates that the inverter fault occurs. Fault: discontinuity across B-C (continuity across A-C), Normal: continuity across B-C (discontinuity across A-C)	Contact capacity 240 VAC 2 A (power factor = 0.4) 30 VDC 1 A
Safety stop signal	S1	Safety stop input (Channel 1)	Terminals S1 and S2 are used for the safety stop input signal for the safety relay module. Terminals S1 and S2 are used at the same time (dual channel). Inverter output is shutdown by shortening/opening between terminals S1 and SIC, or between S2 and SIC. In the initial status, terminals S1 and S2 are shorted with terminal PC by shorting wires. Terminal SIC is shorted with terminal SD. Remove the shorting wires and connect the safety relay module when using the safety stop function.	Input resistance 4.7 kΩ Voltage when contacts are open 21 to 26 VDC Current when contacts are short-circuited 4 to 6 mADC		
	S2	Safety stop input (with 24 VDC input) (Channel 2)				
	SO	Safety monitor output (open collector output)	Indicates the safety stop input signal status. Switched to LOW when the status is other than the internal safety circuit failure. Switched to HIGH during the internal safety circuit failure status. (LOW is when the open collector output transistor is ON (conducted), HIGH is when the transistor is OFF (not conducted).) Refer to the FR-E800 Instruction Manual (Functional Safety) (BCN-A23488-000) when the signal is switched to HIGH while both terminals S1 and S2 are open. (Please contact your sales representative for the manual.)	Permissible load 24 VDC (maximum 27 VDC) 0.1 A (The voltage drop is 3.4 V at maximum while the signal is ON.)		
	SOC	Safety monitor output terminal common	Common terminal for terminal SO.			
Communication	—	Ethernet connector (2-port) *2	Communication can be made via Ethernet. · Category: 100BASE-TX/10BASE-T · Data transmission speed: 100 Mbps (100BASE-TX) / 10 Mbps (10BASE-T) · Transmission method: Baseband · Maximum segment length: 100m between the hub and the inverter · Number of cascade connection stages: Up to 2 (100BASE-TX) / up to 4 (10BASE-T) · Interface: RJ-45 · Number of interfaces available: 1 · IP version: IPv4			
	—	USB connector *3	USB connection with a personal computer can be established. Setting, monitoring and testing of the inverter can be performed using FR Configurator2. · Interface: conforms to USB 1.1 · Transmission Speed: 12 Mbps · Connector: USB mini B connector (receptacle mini B type)			

*1 Terminal functions can be selected using Pr.178, Pr.179 (Input terminal function selection).

*2 Do not connect the parameter unit. The inverter may be damaged.

*3 USB bus power connection is available. The maximum SCCR should be 500 mA.

Option List

By fitting the following options to the inverter, the inverter is provided with more functions.

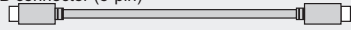
	Name	Type	Applications	Applicable Inverter			Remarks	
				E800	E800-E	E800-SCE		
Plug-in Type	Vector control Orientation control Encoder feedback control	FR-A8AP E kit	Vector control can be performed for encoder-equipped motors (induction motors). The main spindle can be stopped at a specified position (orientation) in combination with an encoder. The motor speed is sent back and the speed is maintained constant.	○	○	○	Shared among all models	
	16-bit digital input	FR-A8AX E kit	This input interface sets the high frequency accuracy of the inverter using an external BCD or binary digital signal. · BCD code 3 digits (maximum 999) · BCD code 4 digits (maximum 9999) · Binary 12 bits (maximum FFFH) · Binary 16 bits (maximum FFFFH)	●	●	○		
	Digital output Extension analog output	FR-A8AY E kit	This option provides the inverter with open collector outputs selected from among the standard output signals. This option adds 2 different signals that can be monitored such as the output frequency and output voltage. 20mADC or 10VDC meter can be connected.	●	●	○		
	Relay output	FR-A8AR E kit	Output any three output signals available with the inverter as standard from the relay contact terminals.	●	●	○		
	CC-Link communication	FR-A8NC E kit	This option allows the inverter to be operated or monitored or the parameter setting to be changed from a computer or programmable controller.	●	●	○		
	DeviceNet communication	FR-A8ND E kit		○	○	○		
	PROFIBUS-DP communication	FR-A8NP E kit		○	○	○		
Stand-alone type	Liquid crystal display operation panel	FR-LU08 (-01)	Graphical operation panel with liquid crystal display	○	-	-	Shared among all models	
	Parameter unit	FR-PU07	Interactive parameter unit with LCD display	○	-	-		
	Parameter unit with battery pack	FR-PU07BB (-L)	This parameter unit enables parameter setting without connecting the inverter to power supply.	○	-	-		
	Enclosure surface operation panel	FR-PA07	This operation panel enables inverter operation and monitoring of frequency, etc. from the enclosure surface	●	-	-		
	Parameter unit connection cable	FR-CB20[]	Cable for connection of operation panel or parameter unit [] indicates a cable length. (1m, 3m, 5m)	●	-	-		
	Encoder cable Mitsubishi Electric vector control dedicated motor (SFV5RU)	FR-V7CBL[]	Connection cable for the inverter and encoder for Mitsubishi Electric vector control dedicated motor (SFV5RU). [] indicates a cable length. (5m, 15m, 30m)	○	○	○		
	USB cable	MR-J3USBCBL3M Cable length: 3 m	Amplifier connector Mini B connector (5-pin)  Personal computer connector A connector	●	●	○		
	Intercompatibility attachment	FR-E7AT 01/02/03	For installation of a FR-E800 series inverter to the installation holes of FR-A024/A044 series inverter.	●	●	○		3.7K or lower. The option's model varies with the inverter's model.
	Intercompatibility attachment	FR-E8AT03	For installation of a FR-E700/E800 inverter to the installation holes of FR-A024/A044/E700 inverter.	●	●	○		3.7K
	DIN rail attachment	FR-UDA 01 to 03	Attachment for installation on DIN rail	○	○	○		3.7K or lower. The option's model varies with the inverter's model.
	Panel through attachment	FR-E8CN 01 to 06	Using this attachment dissipates the inverter's heat by having the inverter heatsink protrude from the back side of the enclosure.	○	○	○		All capacities. The option's model varies with the inverter's model.
	Totally enclosed structure specification attachment (IP40)	FR-E8CV 01 to 04	Installing the attachment to the inverter changes the protective structure of the inverter to the totally enclosed structure (IP40 equivalent as specified by JEM1030).	○	○	○		
	AC reactor	FR-HAL	For harmonic current reduction and inverter input power factor improvement	▲	▲	○		
	DC reactor	FR-HEL		▲	▲	○		
EMC Directive compliant noise filter	SF, FR-E5NF, FR-S5NFSA	EMC Directive (EN 61800-3 C3) compliant noise filter	▲	▲	○			
EMC compliant EMC filter installation attachment	FR-A5AT03 FR-AAT02 FR-E5T(-02)	For installation of the inverter to the EMC Directive compliant EMC filter (SF).	▲	▲	○			
Radio noise filter	FR-BIF(H)	For radio noise reduction (connect to the input side)	●	●	○	All capacities.		
Line noise filter	FR-B5F01, FR-BLF	For line noise reduction	●	●	○			
Filterpack	FR-BFP2	Combination of power factor improving DC reactor, common mode choke, and capacitive filter	○	○	○	0.4K or higher of the three-phase power input model. The option's model varies with the inverter's model.		

●: Supported ○: To be supported soon ▲: Supported (UL/cUL not yet met) -: Not supported

Name	Type	Applications	Applicable Inverter			Remarks	
			E800	E800-E	E800-SCE		
Stand-alone type	Brake resistor	MRS type, MYS type	For increasing the regenerative braking capability (permissible duty 3%ED)	•	•	○	0.4K or higher. The option's model varies with the inverter's model.
	High-duty brake resistor	FR-ABR	For increasing the regenerative braking capability (permissible duty 10%/6%ED)	▲	▲	○	
	Brake unit, Resistor unit, Discharging resistor	FR-BU2, FR-BR, GZG, GRZG type	For increasing the braking capability of the inverter (for high-inertia load or negative load) Brake unit, electrical-discharge resistor and resistor unit are used in combination	•	•	○	
	Multifunction regeneration converter Dedicated stand-alone reactor Dedicated box-type reactor	FR-XC FR-XCL/FR-XCG FR-XCB	One inverter can handle harmonic suppression and power regeneration. Functions that match the application can be selected by combining the inverter/converter with the dedicated reactor FR-XCB (box-type) or FR-XCL/FR-XCG.	•	•	-	According to capacities
	High power factor converter	FR-HC2	The high power factor converter switches the converter section on/off to reshape an input current waveform into a sine wave, greatly suppressing harmonics. (Used in combination with the standard accessory.)	•	•	-	
	Surge voltage suppression filter	FR-ASF FR-BMF	Filter for suppressing surge voltage on motor	•	•	○	400V: According to capacities 400V: 5.5K or higher According to capacities
Others	Pilot generator	QVAH-10	For tracking operation. 70 V / 35 VAC 500 Hz (at 2500 r/min)	•	•	○	Shared among all models
	Deviation sensor	YVGC-500WNS	For continuous speed control operation (mechanical deviation detection) Output 90VAC /90°	•	•	○	
	Analog frequency meter (64mm × 60mm)	YM-206NRI 1mA	Dedicated frequency meter (graduated to 130 Hz). Moving-coil type DC ammeter	•	-	-	
	Calibration resistor	RV24YN 10kΩ	For frequency meter calibration. Carbon film type B characteristic	•	•	○	
	FR Configurator2 (Inverter setup software)	SW1DND-FRC2	Supports an inverter startup to maintenance.	•	•	○	
	FR Configurator Mobile (Mobile App for Inverters)	-	The app enables operation of inverters using smart phones or tablets.	○	○	○	

•: Supported ○: To be supported soon ▲: Supported (UL/cUL not yet met) -: Not supported

• Trademarks

PROFIBUS, PROFINET, and PROFISafe are either trademarks or registered trademarks of PROFIBUS & PROFINET International.
DeviceNet, EtherNet/IP, and CIP safety are either trademarks or registered trademarks of ODVA.
EtherCAT is a trademark of Beckhoff Automation GmbH.
Safety over EtherCAT is a trademark of Beckhoff Automation GmbH.
MODBUS is a registered trademark of SCHNEIDER ELECTRIC USA, INC.
BACnet is a registered trademark of the American Society of Heating, Refrigerating and Air-Conditioning Engineers (ASHRAE).
Ethernet is a registered trademark of Fuji Xerox Corporation in Japan.
CC-Link IE TSN and CC-Link IE Field Network Basic are registered trademarks of CC-Link Partner Association.
QR Code is a registered trademark of DENSO WAVE INCORPORATED.
App Store is a service mark of Apple Inc.
Google Play and the Google Play logo are trademarks of Google LLC.
Other company and product names herein are the trademarks and registered trademarks of their respective owners.

Mitsubishi Electric's global FA network delivers reliable technologies and security around the world.

■ Production base
 ● Development center
 ● Global FA Center
 ▲ Mechatronics showroom
 ● Mitsubishi Electric sales office

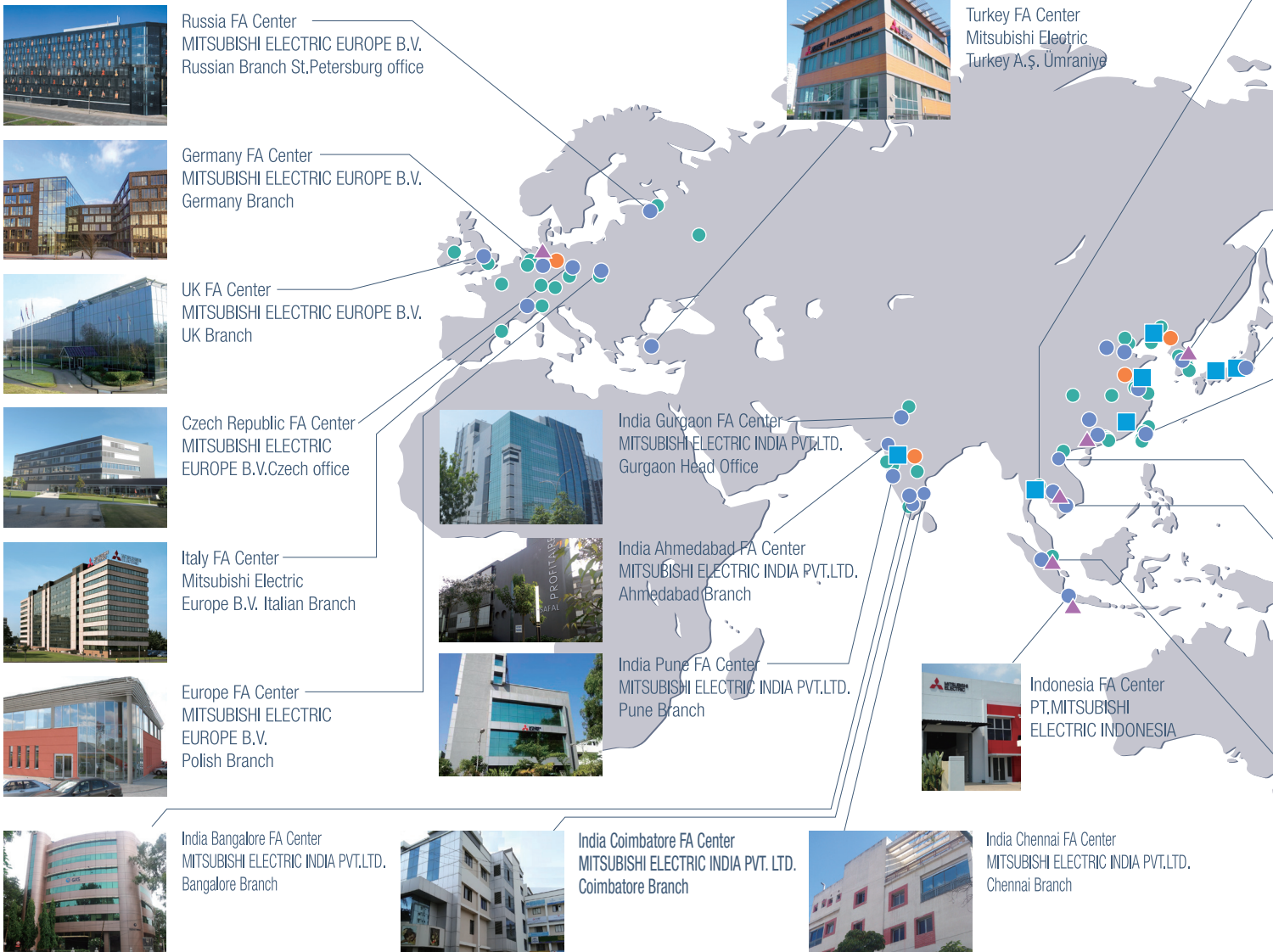

Production bases Under the lead of Nagoya Works, we form a powerful network to optimize our manufacturing processes.

Domestic bases

Nagoya Works



Shinshiro Factory
Kani Factory

Production bases overseas

MDI Mitsubishi Electric Dalian Industrial Products Co., Ltd.



MEAMC Mitsubishi Electric Automation Manufacturing (Changshu) Co., Ltd.

MEATH Mitsubishi Electric Automation (Thailand) Co., Ltd.

MEI Mitsubishi Electric India Pvt.



Thailand FA Center
MITSUBISHI ELECTRIC FACTORY
AUTOMATION (THAILAND) CO.,LTD



Korea FA Center
MITSUBISHI ELECTRIC
AUTOMATION KOREA CO.,LTD.



MITSUBISHI ELECTRIC CORPORATION
Factory Automation Systems Group



Taichung FA Center
MITSUBISHI ELECTRIC
TAIWAN CO.,LTD



Taipei FA Center
SETSUYO ENTERPRISE CO.,LTD



Ho Chi Minh FA Center
MITSUBISHI ELECTRIC
VIETNAM COMPANY
LIMITED



Hanoi FA center
Mitsubishi Electric
Vietnam
Company Limited
Hanoi Branch



ASEAN FA Center
MITSUBISHI ELECTRIC ASIA PTE.LTD.



North America FA Center
MITSUBISHI ELECTRIC
AUTOMATION,INC.



Mexico Monterrey FA Center
Monterrey Office, Mitsubishi
Electric Automation, Inc.



Mexico FA Center
Querétaro Office, Mitsubishi
Electric Automation, Inc.



Mexico City FA Center
Mexico FA Center
Mexico Branch, Mitsubishi
Electric Automation, Inc.



Brazil FA Center
Mitsubishi Electric do Brasil
Comércio e Serviços Ltda.



Brazil Votorantim FA Center
MELCO CNC do Brasil
Comércio e Serviços S.A.



Service bases are established around the world to provide the same services as in Japan globally. Overseas bases are opening one after another to support our customers' business expansion.

Area	Our overseas	FA centers
EMEA	26	7
China	17	4
Asia	31	13
Americas	15	6
Others	1	0
Total	90	30

-As of July 2017

China

Beijing FA Center
MITSUBISHI ELECTRIC
AUTOMATION (CHINA)LTD.



Tianjin FA Center
MITSUBISHI ELECTRIC
AUTOMATION (CHINA)LTD.



Guangzhou FA Center
MITSUBISHI ELECTRIC
AUTOMATION (CHINA)LTD.



Shanghai FA Center
MITSUBISHI ELECTRIC
AUTOMATION (CHINA) LTD.



Mitsubishi Electric Corporation Nagoya Works is a factory certified for ISO14001 (standards for environmental management systems) and ISO9001 (standards for quality assurance management systems)



MITSUBISHI ELECTRIC CORPORATION

HEAD OFFICE: TOKYO BLDG., 2-7-3, MARUNOUCHI, CHIYODA-KU, TOKYO 100-8310, JAPAN