

## Industrial Inverter

(For 3-phase motors)

---

### Instruction Manual

---

High-performance inverter

# *TOSVERT VF-AS3*

3-phase 240V class 0.4 to 55kW

3-phase 480V class 0.4 to 280kW

Safety precautions

I

Introduction

II

Read first

1

Installation and wiring

2

[Basic operation]  
Operation panel and  
screen display

3

[Basic operation]  
Operation methods of  
motor

4

[Fundamental  
operation] How to use  
parameters

5

[Advanced] How to  
use parameters

6

Operating using  
external signals

7

Monitoring operation  
status

8

Measures to satisfy  
standards

9

Selection and  
installation of  
peripheral devices

10

Table of parameters

11

Specifications

12

Trip information and  
measures

13

Maintenance and  
inspection

14

Warranty

15

Disposal

16

**TOSHIBA INDUSTRIAL PRODUCTS AND SYSTEMS CORPORATION**

Notice

1. Make sure that this instruction manual is delivered to the end user of the inverter unit.
2. Read this manual before installing or operating the inverter unit, and store it in a safe place for reference.



# I

## Safety precautions

I

II

The items described in the instruction manual and on the inverter itself are very important so that you can use safely the inverter, prevent injury to yourself and other people around you as well as to prevent damage to property in the area. Thoroughly familiarize yourself with the symbols and indications shown below and then continue to read the manual. Make sure that you observe all warnings given.

1

2

3

4

5

6

7

8

9

10

11

12



13

14

15

16



### Explanation of markings

Marking	Meaning of marking
 WARNING	Indicates that errors in operation will lead to death or serious injury.
 CAUTION	Indicates that errors in operation will lead to injury <sup>*1</sup> to people or that these errors will cause damage to physical property <sup>*2</sup> .

\*1 Such things as injury, burns or electric shock that will not require hospitalization or long periods of outpatient treatment.

\*2 Physical property damage refers to wide-ranging damage to assets and materials.

### Meanings of symbols

Marking	Meaning of marking
	Indicates an inhibition (Don't do it). Detailed information on the inhibition is described in illustration and text in or near the symbol.
	Indicates a mandatory action that must be followed. Detailed information on the mandatory action is described in illustration and text in or near the symbol.
	Indicates a warning or caution. Detailed information on the warning or caution is described in illustration and text in or near the symbol.

I

■ Limits in purpose



This inverter is used for controlling speeds of three-phase motors in general industrial use.

 Safety precautions

- This product is intended for general purpose uses in industrial application. It cannot be used for application which will cause big impact on public and require special quality control, such as power plant and railway, and equipment in which failure and operational errors of this product can endanger human life or harm a human body, such as equipment for nuclear power control, aviation, space flight control, traffic, medical, safety device, and amusement. However, it is possible to verify the application propriety under the condition that purpose is limited and special quality control is not required. Please contact your Toshiba distributor if you wish to use this product for a specific purpose.
- Please use our product for application which will not cause serious accident or damage even if the product has failure, or please use our product in environment where a backup circuit, device is provided as a system outside the product or a safety device functions.
- Please do not use our product for any load other than three-phase motors in general industrial use. Use in other than proper three-phase motors can cause an accident.

■ Handling

 Warning



 Disassembly inhibited	<ul style="list-style-type: none"> <li>• Never disassemble, modify or repair. This can result in electric shock, fire and other injury. Please call your Toshiba distributor for repairs.</li> </ul>
 Prohibited	<ul style="list-style-type: none"> <li>• Never remove the front cover when the power is on. The unit contains high voltage parts and contact with them will result in electric shock.</li> <li>• Do not stick your fingers into openings such as cable wiring holes and cooling fan covers. The unit contains high voltage parts and contact with them will result in electric shock.</li> <li>• Do not place or insert any kind of object (electrical wire cuttings, rods, wires etc.) inside the inverter. This will cause a short circuit and result in electric shock or fire.</li> <li>• Do not allow water or any other fluids to come in contact with the inverter. This will cause a short circuit and result in electric shock or fire.</li> </ul>
 Mandatory action	<ul style="list-style-type: none"> <li>• Turn the power on only after attaching the front cover. If you turn the power on without attaching the front cover, this will result in electric shock or other injury.</li> <li>• Immediately turn the power off if the inverter begins to emit smoke or an unusual odor, or unusual sounds. Continuous use of the inverter in such a state will cause fire. If the inverter is left to be turned on in that state, it can cause fire. Please call your Toshiba distributor for repairs.</li> <li>• Always turn the power off if the inverter is not used for long time.</li> <li>• The inverter will have failure due to leakage current caused by dust and other material. If the inverter's power is left to be turned on in that state, it can cause fire.</li> </ul>

 **Caution**

 Contact inhibited	<ul style="list-style-type: none"> <li>Do not touch heat radiating fins or discharge resistors. These devices get high temperature, and you will get burned if you touch them.</li> </ul>
--	---



**■ Transportation & installation**

 **Warning**

 Prohibited	<ul style="list-style-type: none"> <li>Do not install and operate the inverter if it is damaged or any of its components is missing. This will result in electric shock or fire. Please call your Toshiba distributor for repairs.</li> <li>Do not place any inflammable object near the inverter. If flame is emitted due to failure in the inverter, this will lead to fire.</li> <li>Do not install the inverter in any location where the inverter could come into contact with water or other fluids.</li> <li>This will result in electric shock or fire.</li> </ul>
 Mandatory action	<ul style="list-style-type: none"> <li>Operate under the environmental conditions prescribed in the instruction manual. Operations under any other conditions will result in failure.</li> <li>Mount the inverter on a metal plate. The rear panel will get high temperature. Do not mount the inverter on an inflammable object, this will result in fire.</li> <li>Do not operate the inverter with the front cover removed. The unit contains high voltage parts and contact with them will result in electric shock.</li> <li>An emergency stop device must be installed that is configured in accordance with the system specifications. If such an emergency stop device that can activate mechanical brake by shutting off power supply is not installed, operation cannot be stopped immediately by the inverter alone, thus resulting in an accident or injury.</li> <li>All options to be used must be those specified by Toshiba. The use of options other than those specified by Toshiba will result in an accident.</li> <li>In using a power distribution device and options for the inverter, they must be installed in a cabinet. When they are not installed in the cabinet, this will result in electric shock.</li> </ul>



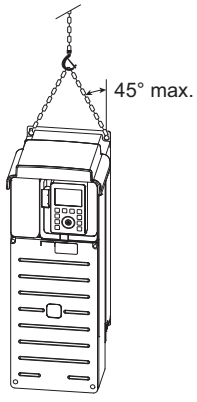

I

 **Caution**



 Prohibited	<ul style="list-style-type: none"> <li>• For transporting or carrying the inverter, do not hold by the front cover. The cover will come off and the unit will drop, resulting in injury.</li> <li>• Do not install the inverter in any place with large vibration. The unit will fall due to the vibration, resulting in injury.</li> </ul>
 Mandatory action	<ul style="list-style-type: none"> <li>• Carry the inverter by two people or more when the inverter is the model mass 20kg or more (VFAS3-2110P - 2370P, VFAS3-4220PC - 4750PC). If you carry the inverter alone, this will result in injury.</li> <li>• Transport a large-capacity inverter (VFAS3-2450P, 2550P, VFAS3-4900PC - 4280KPC) by a crane. If you transport a heavy load by hand, this will result in injury. Please take the utmost care for the operator's safety, and please handle the inverter carefully in order not to damage the product. For lifting the inverter, hang the inverter with wire ropes via hanging bolts (hanging holes) provided at upper part or lower part of the inverter as shown below.</li> </ul> <div style="text-align: center; margin: 10px 0;">  </div> <ul style="list-style-type: none"> <li>• Please make sure that the inverter is hanged by two wire ropes in a balanced manner, and please be careful that the inverter does not receive excessive force during the hanging operation.</li> <li>• Do not carry the inverter with the cover attached, hold nor put the hand in the wiring holes during the transportation. You can have your hands pinched and injured.</li> <li>• Transport the operation panel in accordance with law. Please transport the operation panel by airplane or ship in accordance with law as a lithium battery is used in the operation panel.</li> <li>• Install the inverter at a place which can support the unit's mass. If you install the inverter at a place which does not support the unit's mass, the unit will fall, resulting in injury.</li> <li>• Install the mechanical brake when it is necessary to hold a motor shaft. A brake function of the inverter cannot perform mechanical hold, and it results in injury.</li> <li>• When ambient temperature is above 50°C, use the operation panel by detaching it from the unit. There is a risk that heat can rise up and flame can be emitted in the lithium battery used in the operation panel. When ambient temperature is above 50°C, use the operation panel by detaching the panel from the unit and extending the panel.</li> </ul>

■ Wiring

I

 <b>Warning</b>	
 Prohibited	<ul style="list-style-type: none"> <li>Do not connect power supply to the output (motor side) terminals [U/T1], [V/T2] and [W/T3]. Connecting power supply to the output will damage the inverter and result in fire.</li> <li>Do not insert a braking resistor between DC terminals [PA/+] and [PC/-] or [PO] and [PC/-]. This will result in fire. Please connect the braking resistor in accordance with the instruction manual.</li> <li>Do not touch wires of equipment (e.g. ELCB) that is connected to the inverter power side at least 15 minutes after turning off the power. If an electric charge remains in a capacitor in the inverter, touching the wires before the indicated time will result in electric shock.</li> <li>Do not touch output terminals [U/T1], [V/T2] and [W/T3] on the PM motor side while the PM motor is rotating even after turning off the power. While the PM motor is rotating even after the power is turned off, as a high voltage is generated in the output terminals [U/T1], [V/T2] and [W/T3] on the PM motor side, touching the output terminals will result in electric shock. Please perform wiring after verifying that the PM motor is stopped.</li> <li>When using this 480V class inverter with a power supply system that is grounded in other than the neutral point (e.g. when the power supply has delta connection with single phase grounding), the grounding capacitor should not be grounded (or the capacity of the grounding capacitor should not be increased). Otherwise, it will result in failure or fire.</li> </ul>
 Mandatory action	<ul style="list-style-type: none"> <li>Electrical construction work must be done by a qualified expert. Erroneous connection of power supply by someone who does not have that expert knowledge will result in fire or electric shock.</li> <li>Connect output terminals (motor side) correctly. If the phase sequence is incorrect, the motor will operate in reverse and that can result in injury.</li> <li>Wiring must be done after installation. If you perform wiring prior to installation, this will result in electric shock or other injury. Verify that the power is turned off and the charge lamp is off before starting wiring. If you perform wiring without verification, this will result in electric shock.</li> <li>Install an earth leakage circuit breaker (ELCB) between the power supply and the inverter (primary side) if protective device against earth leakage is not installed into your system.</li> <li>Tighten the screws on the terminal block to specified torque. If the screws are not tightened sufficiently to the specified torque, this will result in fire.</li> <li>Verify that the power supply voltage is within +10% and -15% (<math>\pm 10\%</math> when the load is 100% in continuous operation) of the applied power supply voltage written on the name plate. If you do not use the appropriate power supply voltage, this will result in failure or fire.</li> </ul>
 Be grounded	<ul style="list-style-type: none"> <li>The grounding wire must be connected securely. If the grounding wire is not securely connected, when the inverter has failure or earth leakage, this will result in electric shock or fire.</li> </ul>

I



 <b>Caution</b>	
 Prohibited	<ul style="list-style-type: none"> <li>• Do not attach devices with built-in capacitors (such as noise reduction filters or surge absorbers) to the output terminals (motor side). Heat rises up and this could cause a fire.</li> <li>• Do not switch only one of two grounding capacitor switch screws in the same form. The inverter will have failure due to insufficient switching. Please switch two grounding capacitor switch screws in the same form.</li> <li>• Do not detach the operation panel from the unit when the power is ON. This will result in failure. Please detach the operation panel after turning the power off.</li> <li>• When you connect a USB cable to the operation panel, do not perform the connection while the operation panel is attached to the unit. This will result in failure. Please connect the USB cable to the operation panel after detaching the operation panel from the unit.</li> <li>• Do not connect Ethernet to the RS485 communication connector. Erroneous connection will result in failure.</li> <li>• Do not connect RS485 communication to the Ethernet connector. Erroneous connection will result in failure.</li> </ul>
 Mandatory action	<ul style="list-style-type: none"> <li>• Verify that the power is OFF before detaching the front cover. If you detach the front cover while the power is ON, this will result in electric shock or other injury.</li> <li>• Mount the front cover after wiring. If you turn the power on without attaching the front cover, this will result in electric shock or other injury. Please be careful that if you press too hard the front cover by a screwdriver for attachment, it will damage the inverter unit.</li> <li>• Mount the attached DC reactor (DCL) for VFAS3-4160KPC - 4280KPC. If you do not mount the attached DC reactor (DCL), it will result in failure. Mount the DC reactor (DCL) between [PA/+] and [PO].</li> <li>• Supply AC power supply to cooling fans if you use VFAS3-4160KPC - 4280KPC with DC input. If you do not supply AC power supply, the cooling fans do not operate, and this will result in overheat trip.</li> </ul>



■ Operations

I

 **Warning**

 Prohibited	<ul style="list-style-type: none"> <li>• Do not touch terminals when the inverter's power is on even if the motor is stopped. Touching the terminals while voltage is applied will result in electric shock.</li> <li>• Do not touch switches when the hands are wet and do not try to clean the inverter with a damp cloth. This will result in electric shock.</li> <li>• Do not touch terminals or motor of the inverter while performing auto tuning. Touching the terminals or motor while voltage is applied to the terminals and motor may result in electric shock, even if the motor is stopped. After setting offline auto-tuning (F400 = "2"), execute the auto tuning at first start of the inverter. The auto tuning takes several seconds and the motor is stopped meanwhile, but voltage is applied to the terminals and motor. The motor may also generate a sound during the auto tuning, but this is not malfunction.</li> </ul>
 Mandatory action	<ul style="list-style-type: none"> <li>• Turn the power on only after mounting the front cover. When you use the inverter housed in the cabinet with the front cover removed, always close the cabinet doors first and then turn the power on. If you turn the power on with the front cover or the cabinet doors open, this will result in electric shock.</li> <li>• Make sure to set the setup menu correctly. If you set the setup menu incorrectly, this will damage the inverter or cause the inverter to perform unexpected movement.</li> <li>• Make sure to set the parameter correctly. If you set the parameter incorrectly, this will damage the inverter or cause the inverter to perform unexpected movement. When you write the parameter in the inverter via a parameter writer or operation panel, please transmit correct data.</li> <li>• Make sure that operation instructions are off before resetting the inverter after malfunction. If the inverter is reset while the operation instructions are on, the motor will restart suddenly, resulting in injury.</li> <li>• Install circuit protection such as the mechanical brake in the crane. If there is no sufficient circuit protection installed in the crane, insufficient motor torque while auto tuning will cause the machine stalling/falling.</li> </ul>

 **Caution**

 Prohibited	<ul style="list-style-type: none"> <li>• Observe all allowable operating ranges of motors and machines in use. Not observing these ranges will result in damage to motors and machines and injury. Please use motors and machines within their respective allowable operating ranges by referring to their respective instruction manuals.</li> <li>• Do not set the stall prevention level parameters (F601 and F185) extremely low. If the stall prevention level parameters (F601 and F185) are set at or below the motor no-load current, the stall preventive function will be always enabled and increase the frequency when it judges that regenerative braking is taking place. Do not set the stall prevention level parameters (F601 and F185) at 30% or less under normal use conditions.</li> </ul>
---	---

Mandatory  
action

- Use the inverter that conforms to specifications of the power supply and the three-phase motor to be operated.  
If you use the inappropriate inverter, not only will the three-phase motor not rotate correctly, but it will cause serious accidents such as overheating and burning out.
- Take countermeasures against leakage current.  
The leakage current through the stray capacitance of the input/output power wires of inverter and motor can affect peripheral devices. In that case, please take countermeasures such as reducing the carrier frequency or shortening the length of input/output power wires. When the total wire length (total length between an inverter and motors) is more than 100m, if the trip occurs with the motor no-load current, make enough space between phase wires or insert the filter (MSF: motor-end surge voltage suppression filter).

### ■ When operation by communication or extension panel is selected

#### Warning

Mandatory  
action

- Set the parameter Communication time-out.  
If the parameter is not properly set, the inverter cannot be stopped immediately and this will result in injury and accidents.
- Install an emergency stop device and an interlock that are configured in accordance with the system specifications.  
If the inverter cannot be stopped immediately via communication or the extension panel, this will result in injury and accidents.

### ■ When auto-restart after momentary stop function is selected

#### Caution

Mandatory  
action

- When the auto-restart after momentary stop function is selected, stand clear of motors and machines at momentary power failure.  
The motors and machines which have stopped due to momentary power failure will restart suddenly after power is restored, and this will result in injury.
- Attach caution labels indicating functions programmed for Auto restart, on inverters, motors and machines.  
Please prevent accidents with the caution labels.



### ■ When retry function is selected

#### Caution



Mandatory  
action

- When the retry function is selected, stand clear of motors and machines at tripping stop.  
The motors and machines which have stopped due to tripping stop will restart suddenly, and this will result in injury.  
Take measures for securing safety even if the motor restarts unexpectedly, such as attaching a cover to the motor.
- Attach caution labels indicating functions programmed for Retry, on inverters, motors and machines.  
Please prevent accidents with the caution labels.

■ Maintenance and inspection



 <b>Warning</b>	
 Prohibited	<ul style="list-style-type: none"> <li>Do not replace parts. This will result in electric shock, fire and other injury. Please call your Toshiba distributor for repairs and replacement of expendable parts.</li> </ul>
 Mandatory action	<ul style="list-style-type: none"> <li>Perform daily inspection and periodic inspection on equipment. If the equipment is not inspected and maintained, faults and malfunctions cannot be discovered and that can result in accidents.</li> <li>Before inspection, perform the following steps.                             <ol style="list-style-type: none"> <li>Turn off the power to the inverter.</li> <li>Wait at least 15 minutes and verify that the charge lamp is no longer lit.</li> <li>Use a tester that can measure DC voltages (800 VDC or more), and verify that the voltage to the DC main circuits between [PA/+] and [PC/-] is 45V or less, and verify that the residual voltage of AC main circuits cable is 45V or less.</li> </ol> </li> </ul> <p>Performing inspection without carrying out these steps can lead to electric shock. When using the PM motor, please verify that the PM motor is stopped. While the PM motor is rotating even after the power is turned off, as a high voltage is generated in the output terminals [U/T1], [V/T2] and [W/T3] on the PM motor side, touching the output terminals will result in electric shock.</p>

■ Disposal

 <b>Caution</b>	
 Mandatory action	<ul style="list-style-type: none"> <li>If you dispose of the inverter, have it done by a specialist in industry waste disposal*1. If you dispose of the inverter by yourself, this can result in explosion of capacitor or production of noxious gases, resulting in injury.</li> <li>When you dispose of the operation panel, insulate the terminals of the lithium battery by wrapping the terminals with tapes. If the terminals contact with other metal or batteries, this will result in heat rising up, explosion, and fire.</li> </ul>

\*1 Persons who specialize in the processing of waste and known as "industrial waste product collectors and transporters" or "industrial waste disposal persons". Please observe any applicable law, regulation, rule or ordinance for industrial waste disposal.

■ Sterilization, insect removal processing for wooden packaging material

 <b>Caution</b>	
 Mandatory action	<ul style="list-style-type: none"> <li>If wooden packaging materials require sterilization, insect removal processing, make sure to employ methods other than fumigation. The fumigation processing may damage electronic parts by generated gas and steam. Especially halogen disinfectants, such as fluorine, chlorine, bromine and iodine cause corrosion inside the capacitors.</li> </ul>

■ Attach caution labels

Shown here are examples of caution labels for preventing accidents that are to be attached to inverters, motors and other equipment.

## I

Be sure to attach the caution labels where it is easily visible when selecting the auto-restart function or the retry function.

(Example of caution label)

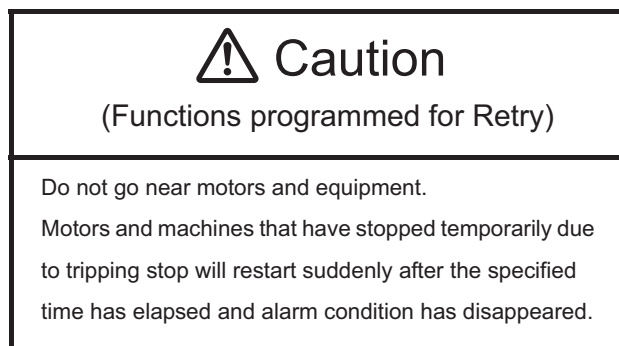
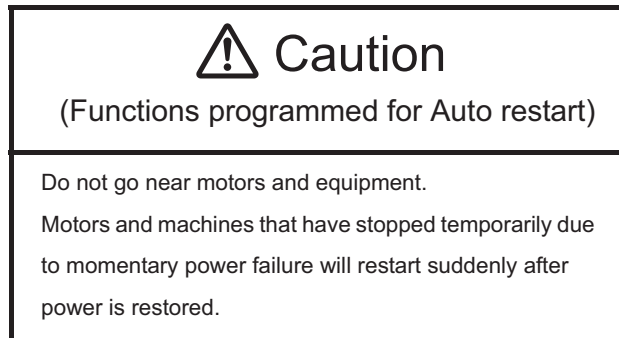

# II

## Introduction

---

Thank you for purchasing Toshiba's industrial inverter.

To handle TOSVERT VF-AS3 correctly, this instruction manual explains how to install and wire the inverter, operation procedure, how to run the motor, measures for protective functions (when an alarm/trip occurs), etc.

It is for the "Ver. 100" and later CPU versions of the inverter.

Please be informed that the specifications described in the instruction manual and technical data, and the CPU version may be changed without notice.

I

II

1

2

3

4

5

6

7

8

9

10

11

12

13

14

15

16



## CONTENTS

I	Safety precautions .....	I-1
II	Introduction .....	II-1
1	Read first.....	1-1
1.1	1.1 Check product purchase .....	1-1
1.2	1.2 Multi-rating .....	1-4
1.3	1.3 Indication of product type.....	1-5
1.4	1.4 Structure of equipment.....	1-7
1.5	1.5 Operation procedure .....	1-14
2	Installation and wiring.....	2-1
2.1	2.1 Installation .....	2-2
2.2	2.2 How to remove covers of inverter .....	2-10
2.3	2.3 Wiring .....	2-25
2.4	2.4 Cautions for application.....	2-64
3	[Basic operation] Operation panel and screen display.....	3-1
3.1	3.1 Basic of operation panel.....	3-1
3.2	3.2 Normal/emergency screen display.....	3-17
4	[Basic operation] Operation methods of motor.....	4-1
4.1	4.1 To run/stop motor.....	4-2
4.2	4.2 Basic setting methods of parameters.....	4-3
4.3	4.3 Basic panel run methods.....	4-20
4.4	4.4 Basic terminal run methods.....	4-27
5	[Fundamental operation] How to use parameters .....	5-1
5.1	5.1 Table of parameter access.....	5-1
5.2	5.2 Settings of main parameters .....	5-1
5.3	5.3 Setting other basic parameters .....	5-34
5.4	5.4 Setting of extended parameters that are especially important.....	5-64
6	[Advanced] How to use parameters.....	6-1
6.1	6.1 Output signals from the control terminals.....	6-1
6.2	6.2 Input signals to the control terminals.....	6-7
6.3	6.3 Selecting terminal functions .....	6-12
6.4	6.4 Switching two to four types of motor characteristics .....	6-16
6.5	6.5 V/f 5-point setting .....	6-19
6.6	6.6 Setting the frequency commands.....	6-20
6.7	6.7 Setting the start and end frequencies .....	6-32
6.8	6.8 DC braking .....	6-36
6.9	6.9 Automatic stop when run continues at the lower limit frequency (sleep function).....	6-42
6.10	6.10 Jog run .....	6-44
6.11	6.11 Jumping the frequency to avoid the resonant frequency .....	6-46
6.12	6.12 Setting the preset-speed operation frequency .....	6-48
6.13	6.13 Bumpless operation .....	6-50
6.14	6.14 Changing carrier frequency to reduce noise and magnetic noise .....	6-52
6.15	6.15 Avoiding trips.....	6-54
6.16	6.16 Single load sharing by multiple inverters (droop control) .....	6-69
6.17	6.17 High-speed operation with light load on cranes .....	6-72
6.18	6.18 Brake sequence .....	6-73
6.19	6.19 Constant speed run with Acc/Dec suspended (dwell operation).....	6-74
6.20	6.20 Switching to commercial power run .....	6-77
6.21	6.21 PID control .....	6-80
6.22	6.22 Retaining the stop position.....	6-81
6.23	6.23 Setting of motor parameters.....	6-82
6.24	6.24 Torque limits.....	6-95
6.25	6.25 Torque control .....	6-104
6.26	6.26 Adjusting current and speed control gain.....	6-107
6.27	6.27 Switching multiple acceleration/deceleration .....	6-108

6. 28	Pattern operation.....	6-114
6. 29	Shock monitoring function.....	6-118
6. 30	Setting the protection functions.....	6-119
6. 31	Forced run control in emergency.....	6-154
6. 32	Frequency adjustment using external input (override function).....	6-156
6. 33	Adjustment parameters.....	6-159
6. 34	Setting functions of operation panel.....	6-164
6. 35	Trace function.....	6-179
6. 36	Store cumulative power.....	6-180
6. 37	Select EASY key function.....	6-181
6. 38	Communication functions.....	6-183
6. 39	Step-out detection of PM motor.....	6-193
6. 40	Traverse function.....	6-194
6. 41	My function.....	6-195
7	Operating using external signals.....	7-1
7. 1	How to externally operate the inverter.....	7-1
7. 2	Applied operation by I/O signals.....	7-2
7. 3	Frequency commands by the analog signals.....	7-14
8	Monitoring operation status.....	8-1
8. 1	Screen display of [Monitor mode].....	8-1
8. 2	Screen display at trip occurrence.....	8-11
9	Measures to satisfy standards.....	9-1
9. 1	How to deal with CE marking.....	9-1
9. 2	Compliance with UL/CSA Standards.....	9-6
9. 3	Compliance with safety standards.....	9-11
10	Selection and installation of peripheral devices.....	10-1
10. 1	Selection of wire size.....	10-1
10. 2	Selection of a wiring device.....	10-4
10. 3	External options.....	10-10
10. 4	Insert type options.....	10-14
11	Table of parameters.....	11-1
11. 1	Frequency setting parameter.....	11-1
11. 2	Basic parameter.....	11-2
11. 3	Extended parameter.....	11-6
11. 4	Advanced parameter.....	11-48
11. 5	Communication parameter.....	11-49
11. 6	Parameter setting range and default setting depending on capacity.....	11-50
11. 7	Analog output/Monitor output function.....	11-56
11. 8	Input terminal function.....	11-59
11. 9	Output terminal function.....	11-63
11. 10	Setup menu.....	11-68
11. 11	Guidance function.....	11-69
12	Specifications.....	12-1
12. 1	Model and main standard specification.....	12-1
12. 2	Outside and Mass.....	12-9
13	Trip information and measures.....	13-1
13. 1	Description of trip and alarm information and measures.....	13-1
13. 2	How to reset trip.....	13-13
13. 3	If motor does not run while no trip message is displayed.....	13-15
13. 4	How to determine causes of other problems.....	13-16
14	Maintenance and inspection.....	14-1
14. 1	Daily inspection and cleaning.....	14-1
14. 2	Periodical inspection.....	14-3
14. 3	In case of a failure.....	14-7
14. 4	Cautions for storage.....	14-7



---

15 Warranty.....	15-1
16 Disposal .....	16-1





# 1 | Read first

I

II

This chapter explains check items when you receive the inverter, names of parts of the inverter, and the flow of basic procedures before operation.

1

## 1.1 Check product purchase

2

3

4

5

6

7

8

9

10

11

12

13

14

15

16

### CAUTION



Mandatory  
action

- Use the inverter that conforms to specifications of the power supply and the three-phase motor to be operated.  
If you use the inappropriate inverter, not only will the three-phase motor not rotate correctly, but it will cause serious accidents such as overheating and burning out.

Before using the product you have purchased, check to make sure that it is exactly what you ordered. Check the contents of packing and accessories for damage.

1

Rating label

**VF-AS3**  
 Model name → VFAS3-4280KPC  
 Rated voltage → 3PH-380/480V  
 Applicable motor capacity → 280kW/400HP (HD) 315kW/500HP (ND)

\* Refer to [1. 2] for (HD) and (ND).

Carton box

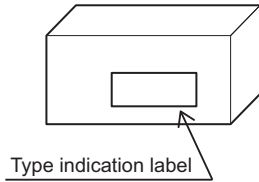

Danger label

**⚠ DANGER**  
**Risk of injury, electric shock or fire.**  
 • Read the instruction manual.  
 • Do not open the cover while power is applied or 15 minutes after power has been removed.  
 • Ensure proper earth connection.

Data matrix

Inverter main unit

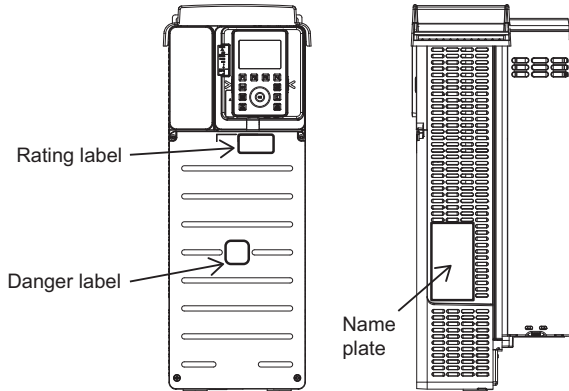

Name plate

Inverter type → TOSHIBA TRANSISTOR INVERTER  
 Inverter rated output capacity → VFAS3-2004P (1)  
 Rated voltage → 0.4kW-1.3kW/0.6HP-0.8HP (HD) / 0.75kW-1.8kW-1HP (ND)  
 Rated input current → 3PH 200/240  
 Rated output current → 0.01590

	INPUT		OUTPUT	
	HD	ND	HD	ND
U(V)	3PH 200/240	3PH 200/240	3PH 200/240	3PH 200/240
FREQ(Hz)	50/60	50/60	0.01590	0.01590
I(A)	1.7 max	2.0 max	3.3	4.2
U(V) (IP)	3PH 200/240	3PH 230		
F(Hz)	60		0.01590	
I(A) (IP)	1.6 max	2.7 max	FLA 3.2	FLA 4.2

SCGR: for rating and protection refer to User Manual  
 Motor Overload Protection: Class 10  
 Manufactured in Indonesia from foreign and domestic components  
 Serial No. 9530 19001503 0001

TOSHIBA INDUSTRIAL PRODUCTS AND SYSTEMS CORPORATION  
 TSIJ

Quick start

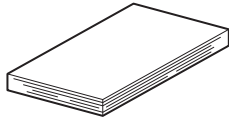

CD-ROM

Instruction manual is included as electronic data.



DC reactor

Only for frame size A7 and A8.

Danger label kit

Danger labels in 6 languages for sticking .

<p><b>⚠ DANGER</b></p> <p>Risque de blessure, d'électrocution ou d'incendie.</p> <ul style="list-style-type: none"> <li>• Lire le manuel d'instruction.</li> <li>• Avant d'intervenir dans le variateur couper la puissance et attendre 15 minutes avant d'ouvrir le couvercle.</li> <li>• Assurer un raccordement approprié à la terre.</li> </ul>	<p><b>⚠ GEFAHR</b></p> <p>Gefahr von Verletzungen, elektrischem Schlag oder Brand.</p> <ul style="list-style-type: none"> <li>• Lesen Sie die Bedienungsanleitung.</li> <li>• Vor öffnen der Abdeckung Gerät vom Netz trennen und 15 Minuten warten.</li> <li>• Sorgen Sie für eine fachgerechte Erdung.</li> </ul>
<p><b>⚠ PERICOLO</b></p> <p>Rischio di lesioni, scosse elettriche o incendi.</p> <ul style="list-style-type: none"> <li>• Leggere le istruzioni del manuale.</li> <li>• Togliere tensione e attendere 15 minuti prima di aprire il coperchio.</li> <li>• Garantire un adeguato collegamento a terra.</li> </ul>	<p><b>⚠ PELIGRO</b></p> <p>Riesgo de daños, descarga eléctrica o fuego.</p> <ul style="list-style-type: none"> <li>• Lea el manual de instrucciones.</li> <li>• Antes de retirar la cubierta corte la alimentación y espere 15 minutos.</li> <li>• Asegure una correcta conexión a tierra.</li> </ul>
<p><b>⚠ 危険</b></p> <p>有受傷、触电、发生火灾的危险。</p> <ul style="list-style-type: none"> <li>• 请仔细阅读使用说明书。</li> <li>• 在运行中或切断电源15分钟之内，请勿揭开盖板。</li> <li>• 务必切实地进行接地。</li> </ul>	<p><b>⚠ 警告</b></p> <p>けが、感電、火災のおそれがあります。</p> <ul style="list-style-type: none"> <li>• 取扱説明書の注意事項を読むこと。</li> <li>• 通電中及び電源遮断後15分以内は端子台カバーを開けないこと。</li> <li>• 確実に接地を行うこと。</li> </ul>

- French
- German
- Italian
- Spanish
- Chinese
- Japanese

1

SF	----	----	RUN
BF	MNS	BF	ERR

Profinet DeviceNet Profibus CANopen

- Labels for communication option
- Affix to lower side of communication indicator.



Important

- When you have purchased VFAS3-4160KPC to VFAS3-4280KPC (frame size A7 or A8), the DC reactor is packed together with the unit. Mount the DC reactor to the inverter by referring to [2. 3. 8].

## 1.2 Multi-rating

This inverter has multi-rating.

Select rating with the parameter <AUL: Multi-rating select> according to the characteristics of the load to be applied.

1

<AUL>="2: ND rating (120%-60s) (0 after execution)"

- Select it to apply equipment with variable torque characteristic.
- Example) Fans, pumps, blowers, etc.

<AUL>="3: HD rating (150%-60s) (0 after execution)"

- Select it to apply equipment with constant torque characteristic.
- Example) Conveyors, load transporting machinery, cranes, mixers, compressors, making machines, machine tools, etc.

Both of them return to "0" after setting.

For details, refer to [5. 3. 2].

This instruction manual describes the motor capacity based on HD rating. In the case of ND rating, it is described with parentheses like (ND: \*\*kW).

# 1.3 Indication of product type

Explanation of the indication of the inverter type.

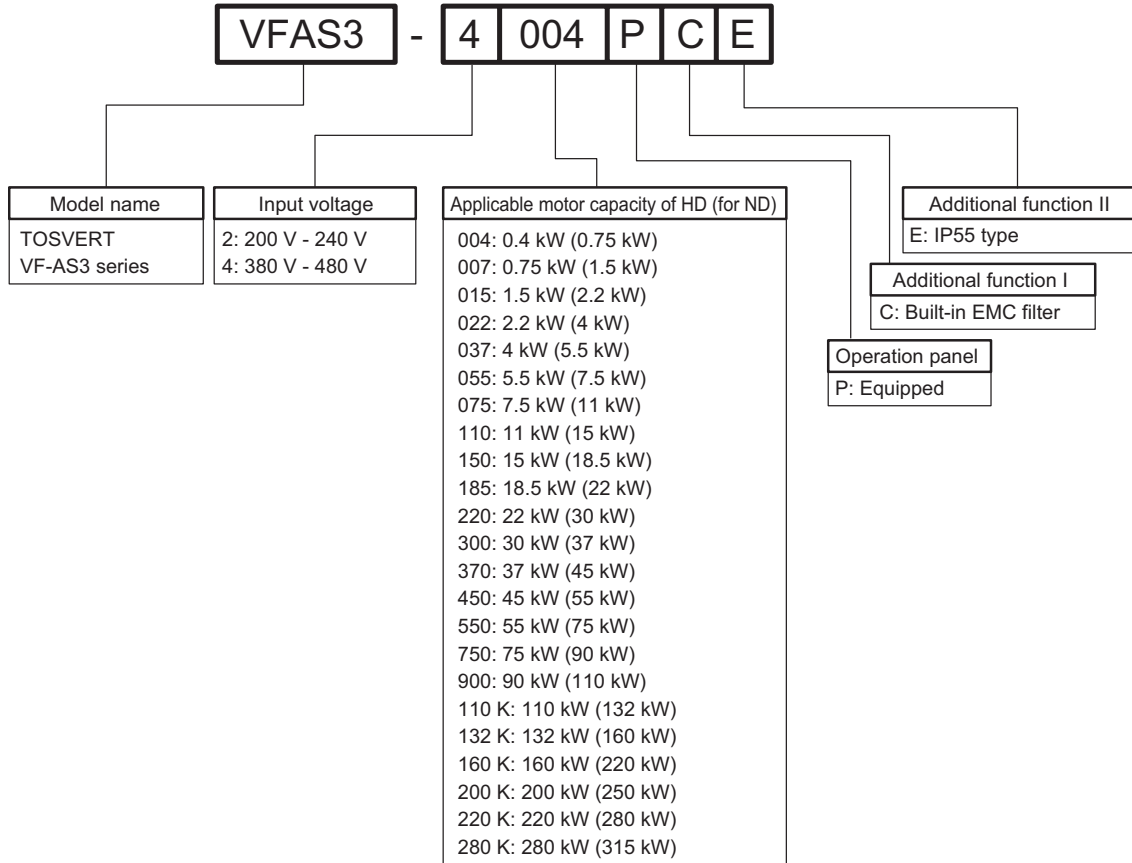

1

Important

- Always shut power off first then check the ratings label of inverter held in a cabinet.
- This inverter has multi-rating. The motor capacity is described based on HD rating. In the case of ND rating, it is described with parentheses like (ND: \*\*kW).

### ■ Type and frame size

This inverter has eight types of units with frame size A1 to A8 according to the voltage class and the capacity. The following table shows the relationships between the types and the frame sizes.

Frame size	Type-Form	
	240V	480V
A1	VFAS3-2004P to 2022P	VFAS3-4004PC to 4037PC
A2	VFAS3-2037P	VFAS3-4055PC, 4075PC
A3	VFAS3-2055P, 2075P	VFAS3-4110PC to 4185PC
A4	VFAS3-2110P to 2185P	VFAS3-4220PC to 4370PC
A5	VFAS3-2220P to 2370P	VFAS3-4450PC to 4750PC

Frame size	Type-Form	
	240V	480V
A6	VFAS3-2450P, 2550P	VFAS3-4900PC to 4132KPC
A7	-	VFAS3-4160KPC
A8	-	VFAS3-4200KPC to 4280KPC

**1**



# 1.4 Structure of equipment

The following is brief explanation of the names and functions of parts that compose the inverter.

## 1.4.1 Outside view

This inverter has eight types of units with frame size A1 to A8 (made of resin or metal) according to the voltage class and the capacity. For details of outside dimensions, refer to [12. 2].

1

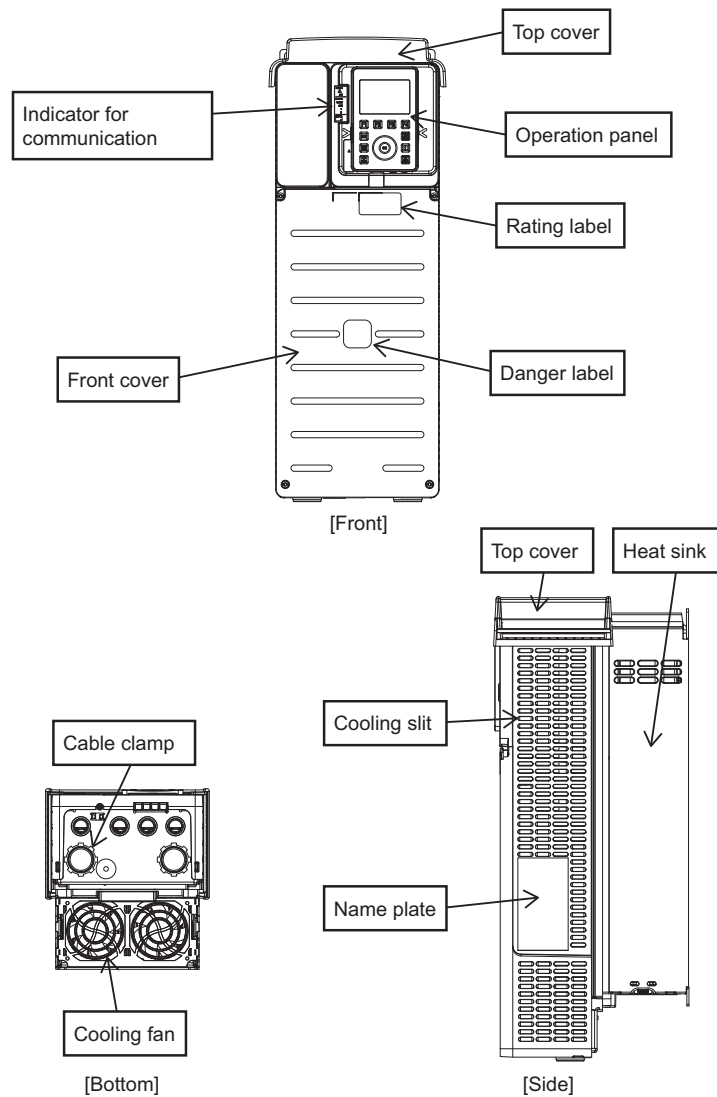

• **Front cover**

A cover for the terminal blocks (power circuit/control circuit). This cover should be removed for wiring to the power terminal block or the control terminal block, using the connector for communication and the option slot, switching the grounding capacitor, or checking the charge lamp. For how to remove, refer to [2. 2].

- **Top cover**

A cover to protect the top of the inverter, which is attached to models with frame size A1 to A5. Remove this cover to install inverters side by side or in a location with ambient temperature above 50°C for heat discharge. For how to remove, refer to [2. 2].

- **With frame size A4 or A5**

**VFAS3-2110P to 2370P, VFAS3-4220PC to 4750PC**

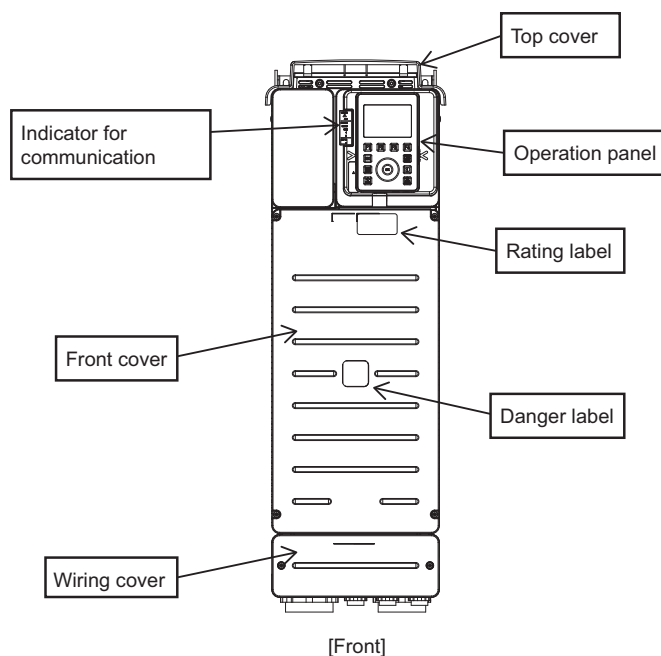
**1**

- **Wiring cover**

The models with frame size A4 or A5 have a cover for wiring beneath the front cover. This cover should be removed to wire to the power terminal block or control terminal block. For how to remove, refer to [2. 2. 2] (frame size A4) or [2. 2. 3] (frame size A5).

## 1. 4. 2 Operation panel and peripherals

The operation panel of the inverter is directly connected to RS485 communication connector 1. It is equipped with some indicators for inverter status on the left side of the operation panel.

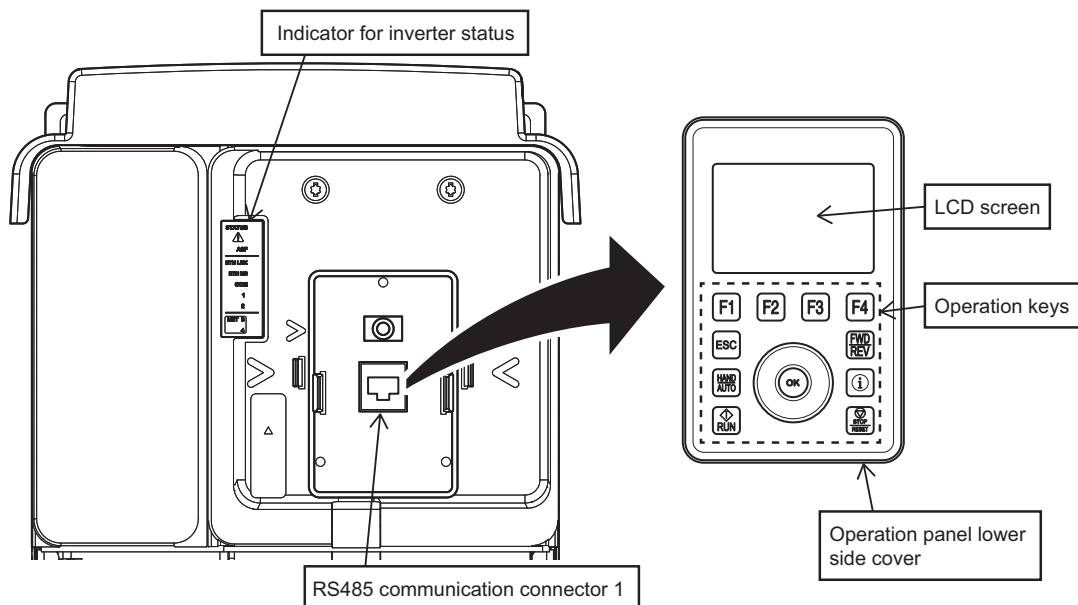

1

### ■ Operation panel

The operation panel is equipped with a LCD screen and operation keys on the front side and two types of connectors (operation panel female connector and USB-miniB connector) on the bottom surface.

It is directly connected to the unit with the operation panel male connector on the back side but can be removed. It can be also used for remote control with Door mounting kit (SBP010Z) and an exclusive cable (optional), see [10. 3. 8] for detail.

#### • LCD screen

The operation panel is equipped with a multilingual (8 languages) LCD that displays the frequency, parameters and their set values and the operation status according to the display mode of the inverter. For details, refer to [3. 1. 1].

#### • Operation keys

There are an [ESC] key, [HAND/AUTO] key, [RUN] key, [FWD/REV] key, [i] key, [STOP/RESET] key, [F1] to [F4] keys, touch wheel, and [OK] key.

The [F1] to [F4] keys execute functions according to the indication on the lower side of the LCD screen.

With the touch wheel, you can change the menu items and values on the screen by touching it by your finger to rotate to the right or left or touching its upper side or lower side lightly.

For details of the operation keys, refer to [3. 1. 1].

#### • Operation panel lower side cover

This cover protects two connectors on the right of the lower side of the operation panel and the slot for battery on the left. The right side/left side of the cover can be opened respectively.

## 1

- **Operation panel female connector**

For handy use, connect the operation panel to this female connector with a cable. To mount the operation panel on the cabinet, use the Door mounting kit SBP010Z (optional).

- **USB-miniB connector**

Used only by manufacturer.

- **Slot for battery**

A lithium battery is inserted to this slot for internal real time clock of the operation panel (equipped as standard at the time of shipping). For how to replace the battery, refer to [14. 2. 2].

- **RS485 communication connector 1**

Normally, this connector is used for connection of the operation panel.

For remote control, connect the operation panel with an exclusive extension cable (optional).

- **LED indicators**

The upper three LEDs indicate the operation status, trip status, and STO (Safe Torque Off) respectively from the top.

**STATUS (Green LED)**

- On: Stopped
- Fast blinking: Run command ON, frequency command 0
- Slow blinking: During run
- Off: Power OFF

 **(Red LED)**

- Blinking: A trip has occurred
- Off: In normal condition

**ASF (Yellow LED)**

- On: STO
- Off: In normal condition

Other seven LEDs indicate the communication status. For details, please see function manual for each communication.

### 1. 4. 3 Terminal blocks

This inverter is equipped with a power terminal block and a control terminal block. To the power terminal block, connect the power supply and the motor. To the control terminal block, connect external control signals.

Both terminal blocks are equipped in the unit and wiring and the connection state cannot be checked during run.

■ **Power terminal block**

The power terminal block to which the power supply and the motor are connected has different shapes and arrangements depending on the type of the inverter.

The following figure shows an example of frame size A1.

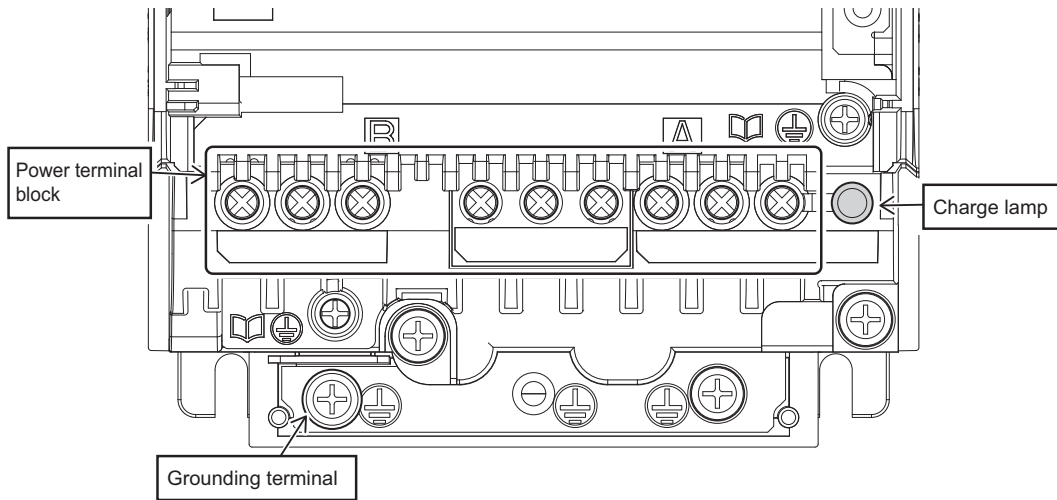

• **Power terminal block**

A cage-type or screw-type terminal block to which the power supply and motor, braking resistor, etc. are connected.

For details of the terminal types and functions, refer to [2. 3. 3].

• **Grounding terminal**

Exclusive terminal to wire a grounding wire.

• **Charge lamp**

While the charge lamp is on, voltage is applied, or high voltage remains in the inverter.

The location of the charge lamp varies depending on the type (frame size).

For details, refer to [2. 2. 6].

**Memo**

- For the layout and shape of power terminal block of each type, refer to [2. 3. 3].

1

■ **Control terminal block**

The control terminal block is common to all the types and is located on the lower side of the operation panel.  
 It connects wiring between the inverter and an external control device.  
 Control terminal block is detachable.

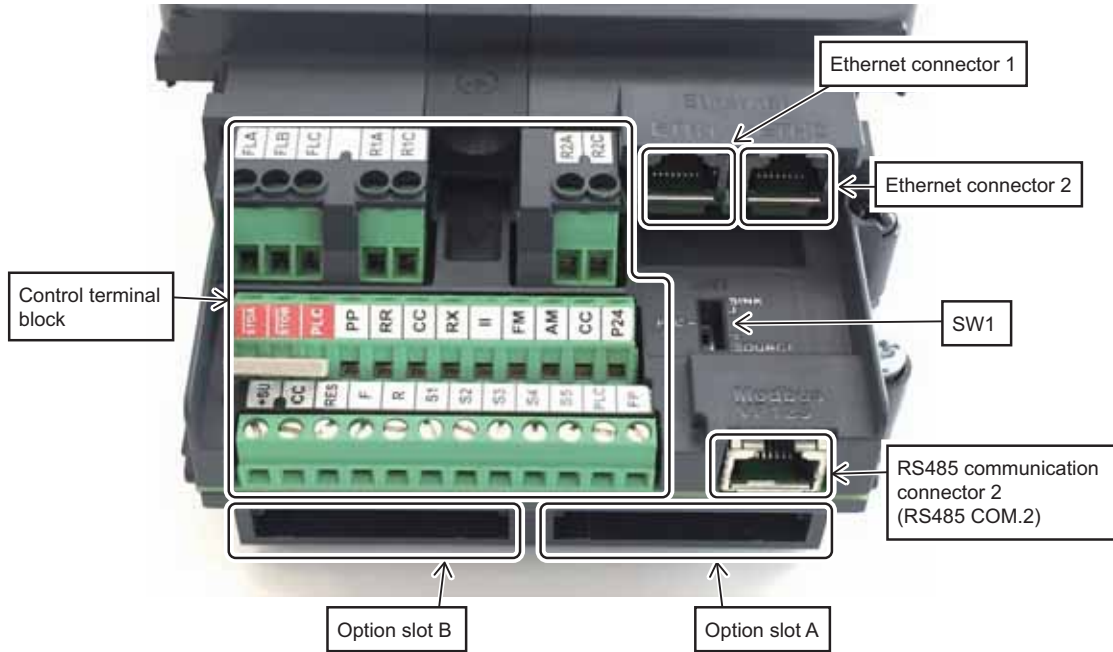

• **Control terminal block**

A cage-type terminal block.  
 For details of the terminal types and functions, refer to [2. 3. 5].

• **SW1**

A switch to switch between the sink logic, source logic and external power supply sink logic of the input terminal.  
 The default setting is PLC (external power supply) side. For details, refer to [2. 3. 5].

• **RS485 communication connector 2 (RS485 COM.2)**

An RJ45 connector for RS485 communication.  
 For details, refer to [2. 3. 6].

• **Ethernet connector 1, 2**

Two RJ45 connectors for Ethernet are equipped.  
 For details, refer to [2. 3. 7].

• **Option slot A, B**

Two slots are equipped in the back of the control terminal block.  
 The right one is slot A and the left one is slot B.  
 Furthermore, an option adaptor can be added between the operation panel and the unit.  
 For details, refer to [10. 4. 3].



Important

- Connection of Ethernet to the RS485 communication connectors may result in a malfunction.

## 1. 4. 4 Features of inverter

This inverter has the following features.

1

### (1) **A detachable LCD operation panel is equipped as standard**

- A touch wheel is adopted for excellent environment resistance.
- With the LCD display (240 x 160 dots), the operation panel has excellent visibility compared with an 7-segment LED display, allowing easy setting of parameters. Furthermore, it supports multiple languages.
- It is equipped with Real time clock that allows to calendar operation.
- Indication of QR Code<sup>®</sup> allows easy access from a smartphone to our website.
- An option to attach a door with IP65 water-proof and dust-proof performance is also provided.

### (2) **Built-in communication function for Ethernet to allow remote monitoring**

- The inverter is equipped with RJ45 connectors for Ethernet and for RS485 communication, two for each of them.

### (3) **Full filling options can be installed to two slots (up to three slots)**

- Cassette-type options for network (DeviceNet<sup>™</sup>, PROFIBUS, PROFINET, etc.), extended terminal block, encoder feedback, and safety function can be added easily.

### (4) **High environmental friendliness and enhanced environment resistance**

- A DC reactor built in as standard suppresses generation of harmonics to comply with IEC61000-3-12.
- An EMC noise filter is built in as standard to comply with C2/C3 (480 V class) of IEC61800-3.
- Comply with the chemicals (3C3)/dust (3S3) standards of IEC60721-3-3. (Frame size A6 or smaller)
- Can be used at an altitude of up to 4800 m. (TN/TT system) (Frame size A6 or smaller)
- A built-in Nema type 1 kit. (Frame size A5 or smaller)
- The inverter is operable at an ambient temperature of -15 to +60°C. ( Frame size A7 and A8:-10 to 60°C)
- The design expectancy life time of the cooling fan, smoothing aluminum electrolytic capacitor for power circuit, and aluminum electrolytic capacitor for control circuit are ten years. (Frame size A6 or smaller)

### (5) **High control performance is realized**

- With its multi-rating, the inverter is usable for a wide range of applications with light load (120% for 1 min) and heavy load (150% for 1 min).
- It is also usable for a PM motor.
- Auto tuning is possible.
- High frequency operation up to 590 Hz is possible.
- High-accuracy motor control is possible.

Note) QR Code is registered trademark of DENSO WAVE INCORPORATED.

# 1.5 Operation procedure

The basic procedure to operate a motor with the inverter is as follows.

1

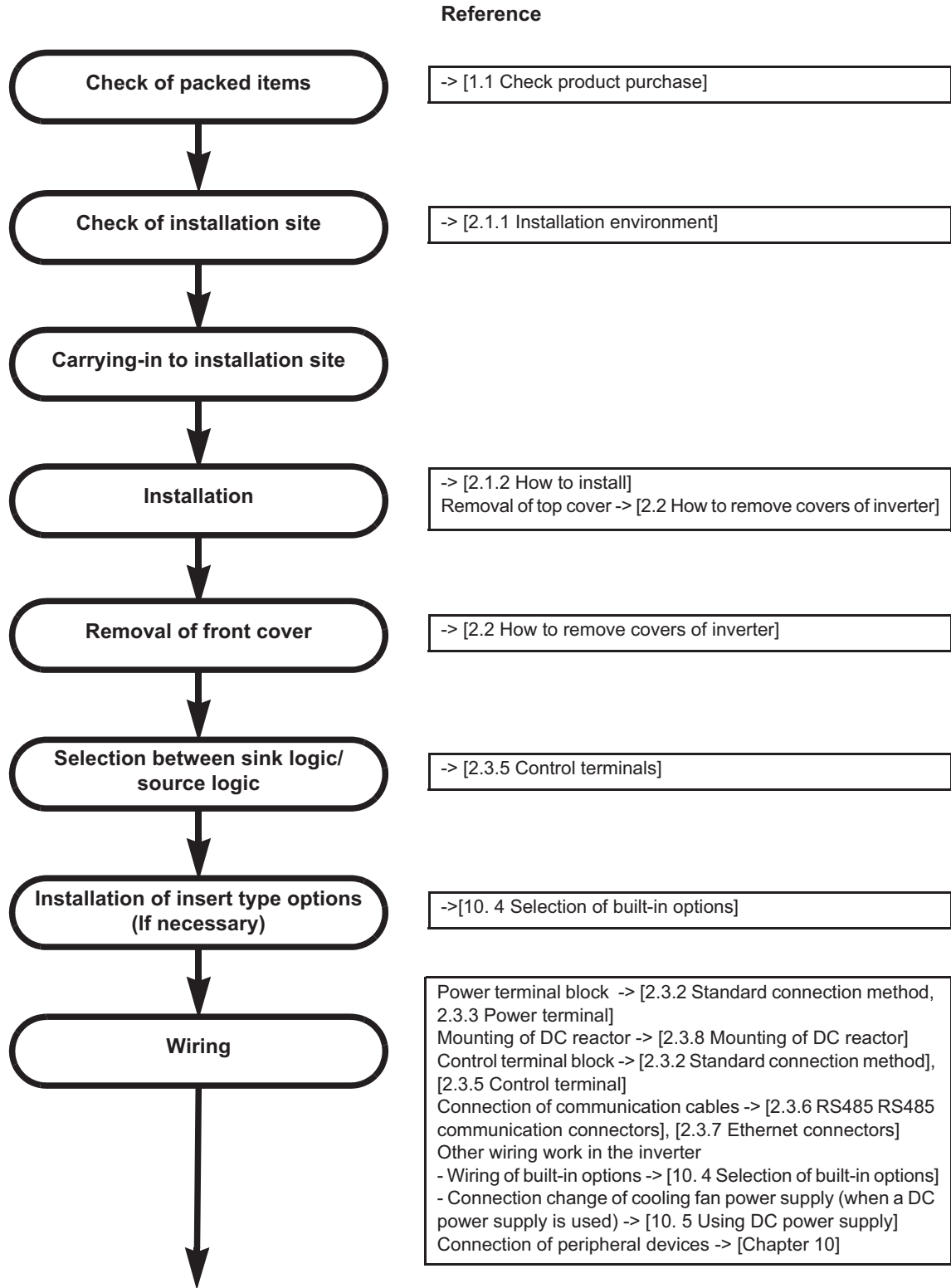



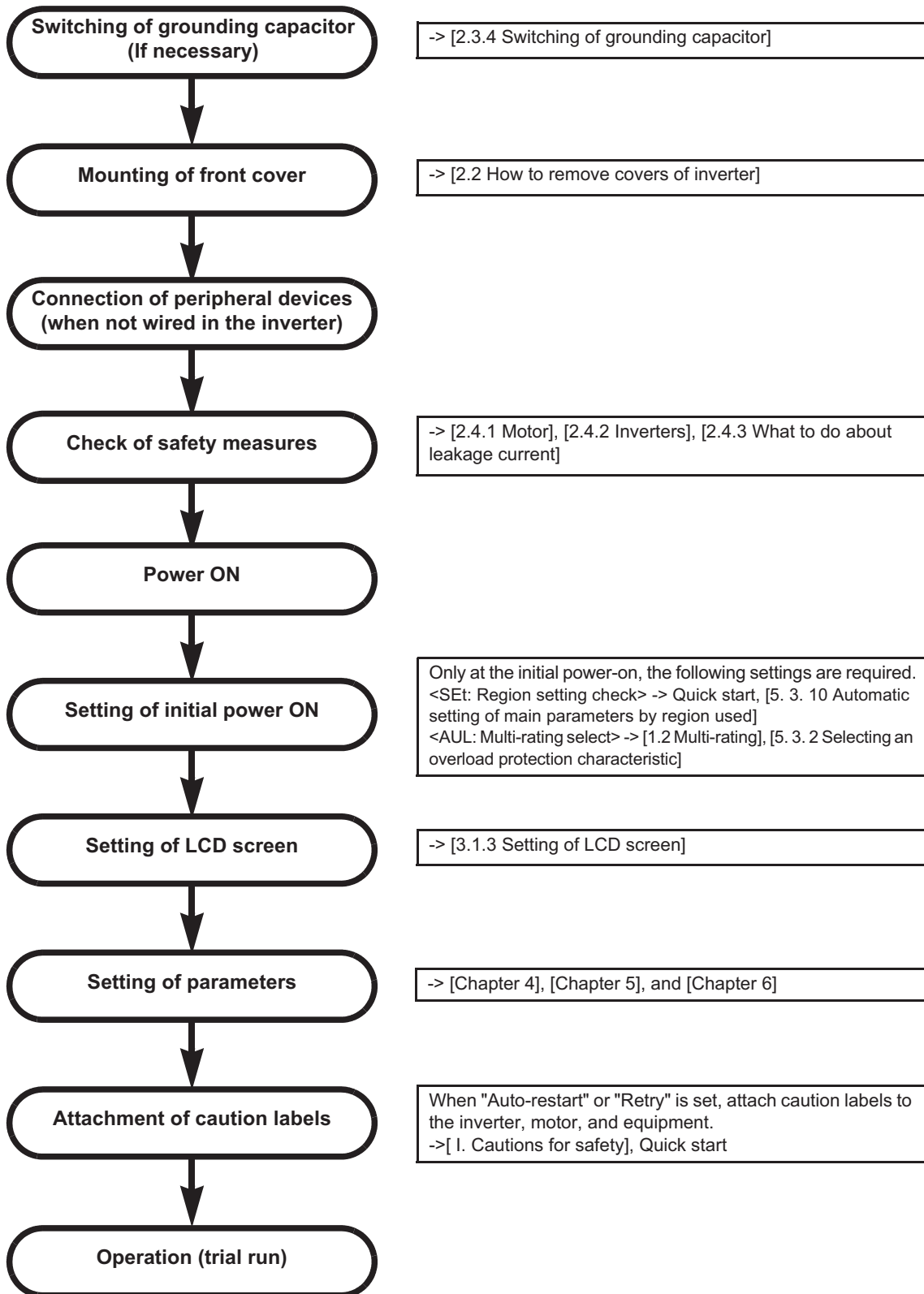



# 2

## Installation and wiring

I

II



### WARNING



Disassembly prohibited

- Never disassemble, modify or repair.  
This can result in electric shock, fire and other injury. Please call your Toshiba distributor for repairs.



Prohibited

- Do not stick your fingers into openings such as cable wiring holes and cooling fan covers. The unit contains high voltage parts and contact with them will result in electric shock.
- Do not place or insert any kind of object (electrical wire cuttings, rods, wires etc.) inside the inverter.  
This will cause a short circuit and result in electric shock or fire.
- Do not allow water or any other fluids to come in contact with the inverter.  
This will cause a short circuit and result in electric shock or fire.



### CAUTION



Prohibited

- For transporting or carrying the inverter, do not hold by the front cover.  
The cover will come off and the unit will drop, resulting in injury.



Mandatory action

- Carry the inverter by two people or more when the inverter is the model mass 20kg or more (VFAS3-2110P - 2370P, VFAS3-4220PC - 4750PC).  
If you carry the inverter alone, this will result in injury.

This chapter explains installation of the inverter, how to remove the covers, how to wire to the power supply and the motor, connection of the control circuit, and functions of terminals and connectors for communication.

1

2

3

4

5

6

7

8

9

10

11

12

13

14

15

16

## 2. 1 Installation

Take special care with the installation environment of the inverter. Install the inverter in a location that secures space for ventilation and heat emitting (in the cabinet, etc.), considering heat generation and occurrence of noise.

### 2. 1. 1 Installation environment

#### WARNING



Prohibited

- Do not place any inflammable object near the inverter. If flame is emitted due to failure in the inverter, this will lead to fire.
- Do not install the inverter in any location where the inverter could come into contact with water or other fluids. This will result in electric shock or fire.



Mandatory action

- Operate under the environmental conditions prescribed in the instruction manual. Operations under any other conditions will result in failure.

#### CAUTION



Prohibited

- Do not install the inverter in any place with large vibration. The unit will fall due to the vibration, resulting in injury.

This inverter is an electronic control instrument. Take full consideration to install it in the proper operating environment as follows.

- (1) **Do not install in any location of high temperature, high humidity, moisture condensation and freezing and avoid locations where there is exposure to water and/or where there may be large amounts of dust, metallic fragments and oil mist.**



- (2) **Do not install in any location where corrosive gases or grinding fluids are present.**
- (3) **Operate in areas where ambient temperature ranges from -15°C to +60°C.**

- When using the inverter in locations with temperatures above 50°C, remove the top cover and operation panel of the inverter to use it.

For details of how to remove the top cover, refer to [2. 2].

- -10 to 60°C for frame size A7 and A8.
- The inverter is a heat-emitting body. Make sure proper space and ventilation are provided when installing in the cabinet.
- Measure the ambient temperature in the positions shown in the figure on the right.

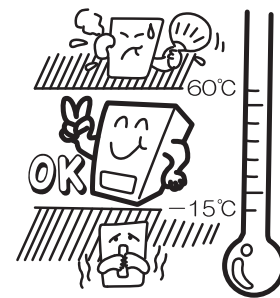

Position for measuring ambient temperature

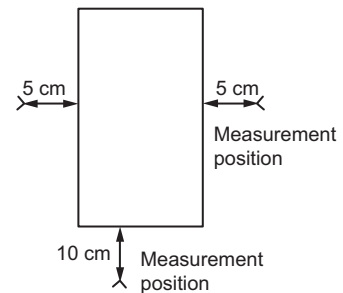

- (4) **Do not touch the heat sink as it may have a high temperature.**

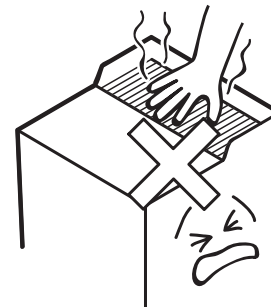

- (5) **Do not install in any location subject to large amounts of vibration.**

- If the inverter is installed in a location that is subject to vibration, anti-vibration measures are required. Please consult with your Toshiba distributor about these measures.



- (6) **If the inverter is installed near any of the equipment listed below, provide measures to insure against errors in operation.**

- Solenoids: Attach a surge suppressor on the coil.
- Brakes: Mount a surge absorber on the coil.
- Magnetic contactors: Mount a surge absorber on the coil.
- Resistors: Place far away from the inverter.

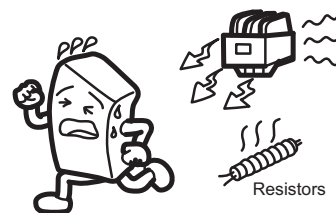

## 2. 1. 2 How to install

### WARNING



Prohibited

- Do not install and operate the inverter if it is damaged or any of its components is missing. This will result in electric shock or fire. Please call your Toshiba distributor for repairs.



Mandatory action

- Mount the inverter on a metal plate. The rear panel will get high temperature. Do not mount the inverter on an inflammable object, this will result in fire.
- Do not operate the inverter with the front cover removed. The unit contains high voltage parts and contact with them will result in electric shock.
- An emergency stop device must be installed that is configured in accordance with the system specifications. If such an emergency stop device that can activate mechanical brake by shutting off power supply is not installed, operation cannot be stopped immediately by the inverter alone, thus resulting in an accident or injury.
- All options to be used must be those specified by Toshiba. The use of options other than those specified by Toshiba will result in an accident.

### CAUTION



Prohibited

- For transporting or carrying the inverter, do not hold by the front cover. The cover will come off and the unit will drop, resulting in injury.



Mandatory action

- Carry the inverter by two people or more when the inverter is the model mass 20kg or more (VFAS3-2110P - 2370P, VFAS3-4220PC - 4750PC). If you carry the inverter alone, this will result in injury.
- Install the inverter at a place which can support the unit's mass. If you install the inverter at a place which does not support the unit's mass, the unit will fall, resulting in injury.
- Install the mechanical brake when it is necessary to hold a motor shaft. A brake function of the inverter cannot perform mechanical hold, and it results in injury.

Select an indoor location with good ventilation, and then install the inverter upright on a flat metal plate. For the positions and sizes of the mounting holes, refer to [12. 2].

#### ■ If multiple inverters are installed

To install multiple inverters in one location, either normal basic installation or side-by-side installation (to align inverters side-by-side horizontally with no space) can be adopted.

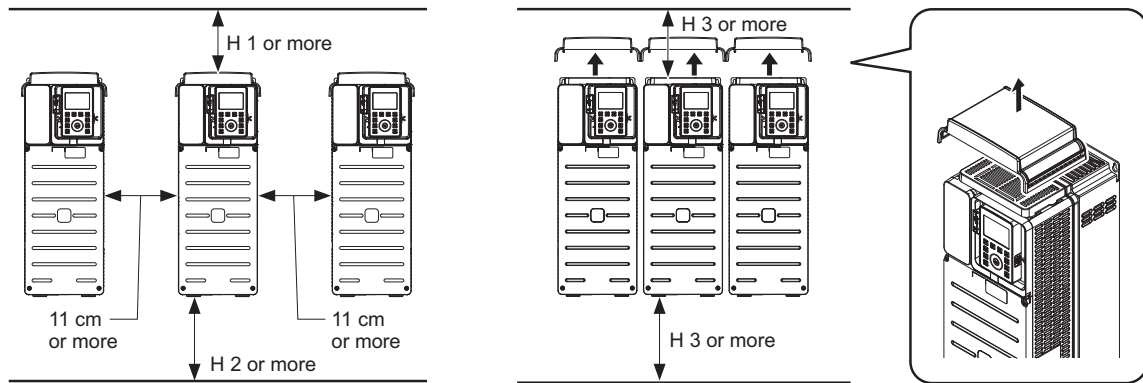

2

Type	H1(cm)	H2(cm)	H3(cm)
VFAS3-2004P - 2370P VFAS3-4004PC - 4750PC	10	10	10
VFAS3-2450P, 2550P VFAS3-4900PC - 4132KPC	25	25	25
VFAS3-4160KPC	15	15	25
VFAS3-4200KPC - 4280KPC	20	15	25

**1) Basic installation**

When installing multiple inverters, leave at least 11 cm or more of space between each inverter and install them aligned horizontally.

When using the inverter in locations with temperatures above 50°C, remove the top cover and operation panel of the inverter (refer to [2. 2]) and use the inverter with the output current reduced (refer to "Instruction manual for load reduction").

**2) Side-by-side installation**

To align the inverters side-by-side horizontally with no space, remove the top cover of the inverter before use (refer to [2. 2]). When using the inverter in locations with temperatures above 50°C, use the inverter with the operation panel removed and use the inverter with the output current reduced (refer to "Instruction manual for load reduction").

The space shown in the figure above is the minimum allowable space. Because the inverter has cooling fans built in on the top or bottom surfaces, make the space on top and bottom as large as possible to allow for air passage.



Important

- Do not install in any location with high humidity or high temperatures and where there are large amounts of dust, metallic fragments and oil mist.

**Memo**

- We also provide models with IP55 protective construction for adverse environments.

**■ Current reduction curve**

The current value of the inverter that can be output continuously varies depending on the installation method, ambient temperature, and the setting of carrier frequency.

For details, refer to "Instruction manual for load reduction" (E6582116).

**■ Calorific values of inverter and required ventilation**

The inverter will lose the power slightly as a result of conversion from AC to DC or from DC to AC. In order to suppress the rise in temperature inside the cabinet when this loss becomes heat loss, the interior of the cabinet must be ventilated and cooled.



The amount of forcible air-cooling ventilation required and the necessary heat discharge surface quantity when operating in a sealed cabinet depending on motor capacity are as follows.

<ND rating>

Input voltage Class	Applicable motor capacity (kW)	Inverter type-form		Frame size	Inverter calorific value (W) *1	Inner side calorific value (W) *1	Forced air-cooled Required ventilation amount (m <sup>3</sup> /min)	Sealed cabinet Necessary heat discharge surface quantity (m <sup>2</sup> )
3-phase 240 V	0.75	VFAS3-	2004P	A1	65	27	0.37	1.30
	1.5		2007P		92	29	0.52	1.83
	2.2		2015P		115	32	0.65	2.31
	4.0		2022P		189	38	1.07	3.79
	5.5		2037P	A2	243	47	1.38	4.85
	7.5		2055P	A3	392	53	2.22	7.84
	11		2075P		544	62	3.09	10.87
	15		2110P	A4	625	90	3.55	12.51
	18.5		2150P		750	101	4.26	15.01
	22		2185P		874	112	4.96	17.49
	30		2220P	A5	1084	136	6.15	21.68
	37		2300P		1384	163	7.86	27.68
	45		2370P		1631	184	9.26	32.63
	55		2450P	A6	2466	278	14.00	49.33
	75		2550P		3432	359	19.48	68.64

\*1 Case of 100% load ND continuous operation. The heat loss for the optional external devices (input reactor, radio noise reduction filters, etc.) is not included in the calorific values in the table.

**2**

Input voltage Class	Applicable motor capacity (kW)	Inverter type-form	Frame size	Inverter calorific value (W) *1	Inner side calorific value (W) *1	Forced air-cooled Required ventilation amount (m <sup>3</sup> /min)	Sealed cabinet Necessary heat discharge surface quantity (m <sup>2</sup> )	
3-phase 480 V	0.75	VFAS3-	4004PC	A1	56	26	0.32	1.13
	1.5		4007PC		79	28	0.45	1.58
	2.2		4015PC		100	30	0.57	2.00
	4.0		4022PC		140	33	0.79	2.80
	5.5		4037PC		192	37	1.09	3.83
	7.5		4055PC	A2	233	45	1.32	4.66
	11		4075PC		323	53	1.84	6.47
	15		4110PC	A3	455	62	2.58	9.10
	18.5		4150PC		557	70	3.16	11.14
	22		4185PC		603	71	3.42	12.06
	30		4220PC	A4	770	94	4.37	15.40
	37		4300PC		939	107	5.33	18.78
	45		4370PC		1101	123	6.25	22.02
	55		4450PC	A5	1094	132	6.21	21.88
	75		4550PC		1589	175	9.02	31.78
	90		4750PC		1827	199	10.37	36.54
	110		4900PC	A6	2920	309	16.58	58.40
	132		4110KPC		3457	358	19.62	69.13
	160		4132KPC		4013	405	22.78	80.26
	220		4160KPC	A7	5404	452	30.68	108.08
250	4220KPC	A8	6279	606	35.64	125.58		
280	4250KPC		6743	769	38.28	134.86		
315	4280KPC		7749	769	43.99	154.98		

\*1 Case of 100% load ND continuous operation. The heat loss for the optional external devices (input reactor, radio noise reduction filters, etc.) is not included in the calorific values in the table.

■ **Panel designing in consideration of effects of noise**

The inverter generates high frequency noise. When designing the control panel, consideration must be given to that noise.

Examples of measures are given below.

- Wire so that the power connections and the control connections are separated. Do not place them in the same conduit, do not run them in parallel, and do not bundle them.
- Provide shielding and twisted wires for control connection.
- Separate the input (power) and output (motor) wires of the power circuit. Do not place them in the same conduit, do not run them in parallel, and do not bundle them.
- Be sure to ground the inverter grounding terminals.
- Install a surge absorber on any magnetic contactor and relay coils used around the inverter.
- Install radio noise reduction filters if necessary.

### ■ When more than one inverter are installed in one cabinet

When two or more inverters are installed in one cabinet, pay attention to the followings.

- Ensure a space of at least 20 cm or more on the top and bottom of the inverters.  
(Note: Depending on the inverter type.)
- Install an air deflecting plate so that the heat rising up from the inverter on the bottom does not affect the inverter on the top.
- Inverters may be installed side by side with each other with no space left between them.

When installing inverters side by side, remove the top cover of the inverter. For how to remove, refer to [2. 2].

When using the inverter in locations with temperatures above 50°C, use the inverter with the operation panel removed and the output current reduced.

2

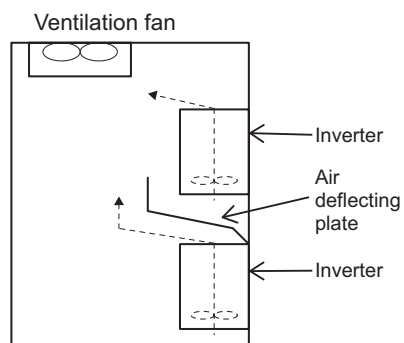

## 2.2 How to remove covers of inverter

### WARNING



Prohibited

- Never remove the front cover when the power is on.  
The unit contains high voltage parts and contact with them will result in electric shock.

### CAUTION



Mandatory  
action

- When removing and mounting the front cover, wiring cover or the power terminal block with a screwdriver, be sure not to scratch your hand as these results in injury.
- Turn the power off when removing the front cover and the wiring cover.  
If the power is on, it can result in electric shock or injury.
- Do not press too hard with the screwdriver.  
It can scratch the inverter unit.
- After wiring is complete, be sure to replace the front cover and the wiring cover.  
Otherwise, it can result in electric shock or fire.

In the following cases, covers of the inverter should be removed.

- **Wiring of the power circuit/control terminal block (refer to [2. 3. 2])**
- **Switching of the control terminal block (refer to [2. 3. 5])**
- **Switching of the grounding capacitor (refer to [2. 3. 4])**
- **Mounting of the DC reactor attached with frame size A7 and A8 (refer to [2. 3. 7])**
- **Mounting of insert type options (refer to [10. 4])**
- **Connection change of the cooling fan power supply when a DC power supply is used (refer to Application manual "DC power supply connect to inverter" (E6582156).**
- **Heat discharge measures in the case of high ambient temperature, side-by-side installation of multiple inverters, etc. (refer to [2. 1. 2])**
- **Removal of installed inverters with frame sizes A1 to A5**

Use the procedure and corresponding figure for each type, shown in following pages, to remove portions such as covers.

**2. 2. 1 With frame size A1, A2, or A3**  
**VFAS3-2004P to 2075P, VFAS3-4004PC to 4185PC**

The parts to be removed are as follows.

- Front cover on the lower side of the front surface (resin)
- Top cover on the top surface (resin)

Each cover can be removed separately.

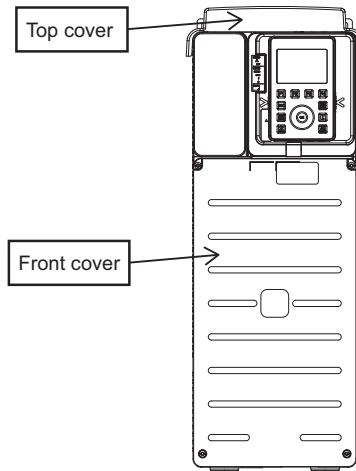

2

■ **Front cover**

- 1 Loosen four screws of the front cover.  
 Since the screws are of falling prevention type, they do not come off the front cover even if loosened.
  
- 2 Hold the both side of the front cover and pull it slightly downward.  
 The inserted part of the upper side of the front cover comes off.  
 The tab shown in the figure on the right also come off.
  
- 3 Pull the front cover toward you and remove it from the unit.
  
- 4 Mount the front cover in the reverse procedure.  
 Pay attention to engagement of the tab and insertion of the upper side of the cover.

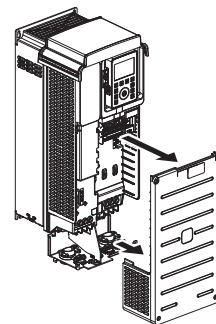
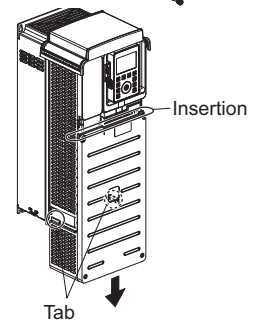
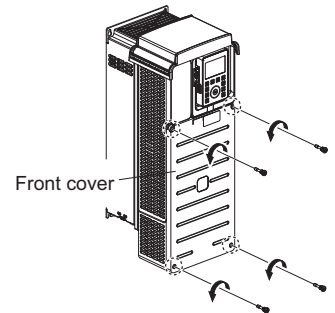

■ **Top cover**

- 1 Put your fingers in the clearance in the back from the upper side of the top cover, and pull the cover toward you while lifting it upward.  
The tab shown in the figure on the right comes off.

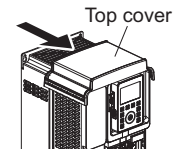

2



Important

- Since the tab is engaged stiffly, removing the top cover can result in injury. Pay enough attention.

- 2 Remove the top cover from the unit.

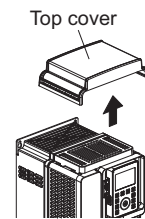

- 3 When mounting the top cover, put it on the top of the unit, adjust the position of the tab, push the cover to fit in.

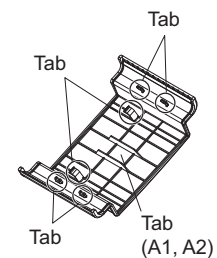

**2. 2. 2 With frame size A4**  
**VFAS3-2110P to 2185P, VFAS3-4220PC to 4370PC**

The parts to be removed are as follows.

- **Front cover in the middle of the front surface (resin)**
- **Wiring cover on the lower side of the front surface (resin)**
- **Top cover on the top surface (resin)**

Each cover can be removed separately.

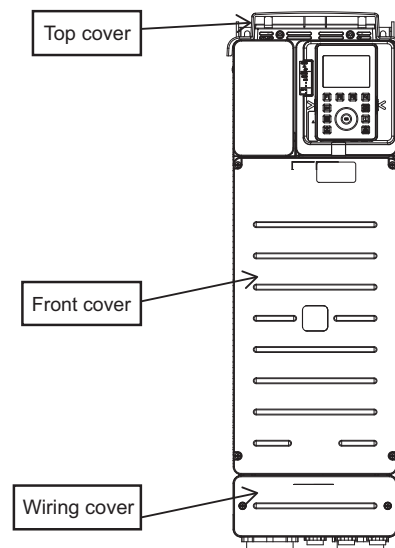

## ■ Front cover

- 1 Loosen four screws of the front cover.  
Since the screws are of falling prevention type, they do not come off the front cover even if loosened.
- 2 Remove the front cover from the unit.  
The upper part of the front cover has no inserted part.
- 3 Mount the front cover in the reverse procedure.

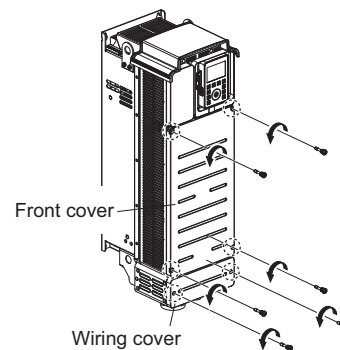

2

## ■ Wiring cover

- 1 Loosen two screws of the wiring cover.  
Since the screws are of falling prevention type, they do not come off the wiring cover even if loosened.
- 2 Remove the wiring cover from the unit.
- 3 Mount the wiring cover in the reverse procedure.

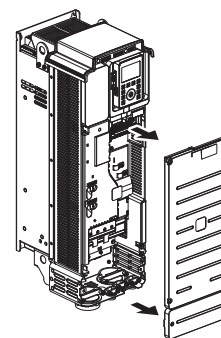

## ■ Top cover

- 1 Put your fingers in the clearance in the back from the upper side of the top cover, and pull the cover toward you to remove it.  
The tab shown in the figure on the right comes off.

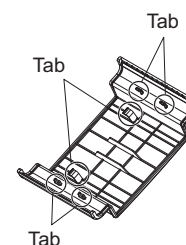
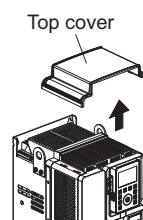
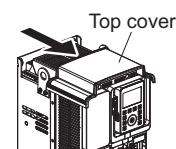

- 2 Mount the top cover in the reverse procedure.

**2. 2. 3 With frame size A5**  
**VFAS3-2220P to 2370P, VFAS3-4450PC to 4750PC**

The parts to be removed are as follows.

- **Front cover in the middle of the front surface (metal)**
- **Wiring cover on the lower side of the front surface (metal)**
- **Top cover on the top surface (metal)**

Each cover can be removed separately.

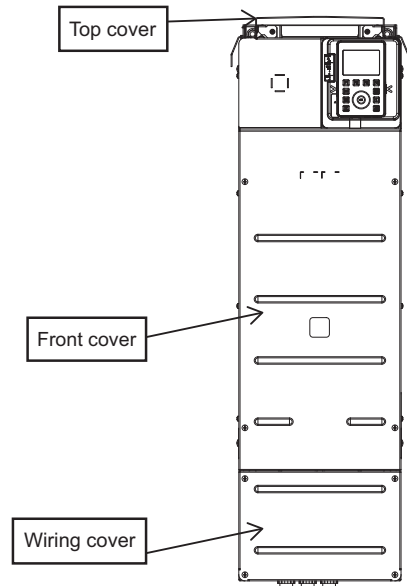

■ **Front cover**

- 1 Remove four screws of the front cover.  
Store the removed screws so as not to be lost.
- 2 Remove the front cover from the unit.
- 3 Mount the front cover in the reverse procedure.

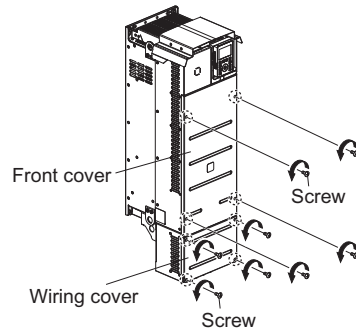

■ **Wiring cover**

- 1 Remove four screws of the wiring cover.  
Store the removed screws so as not to be lost.
- 2 Remove the wiring cover from the unit.
- 3 Mount the wiring cover in the reverse procedure.

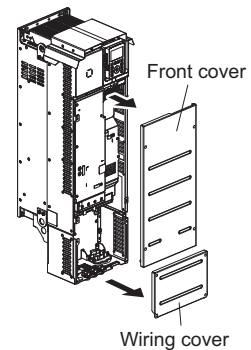



## ■ Top cover

- 1 Remove two screws of the top cover.  
Store the removed screws so as not to be lost.

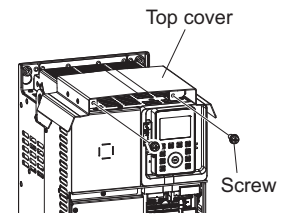

- 2 Pull the top cover slightly toward you.  
The tab shown in the figure on the right comes off.

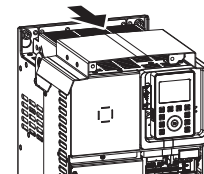

- 3 Lift the top cover upward and remove it from the unit.

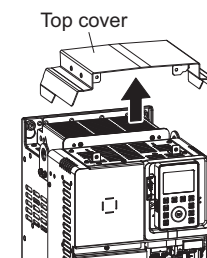

- 4 Mount the top cover in the reverse procedure.

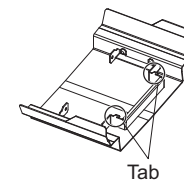

### 2. 2. 4 **With frame size A6** **VFAS3-2450P, 2550P,** **VFAS3-4900PC to 4132KPC**

The parts to be removed are as follows.

- **Front cover on the lower side of the front surface (metal)**
- **Transparent cover inside the front cover above (transparent resin)**
- **Wiring duct inside the front cover above (black resin)**

The top cover is never removed.

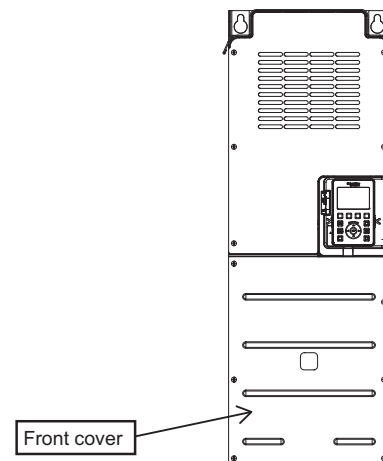

**2**

■ **Front cover**

- 1 Remove six screws of the front cover.  
Store the removed screws so as not to be lost.

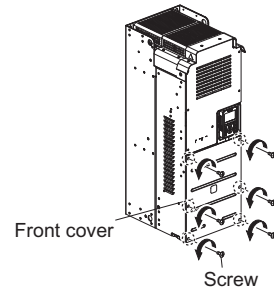

- 2 Lift the bottom end of the front cover, pull the entire cover downward and remove it from the unit.  
Since the upper part of the front cover has an inserted part, the cover cannot be removed just by lifting it.

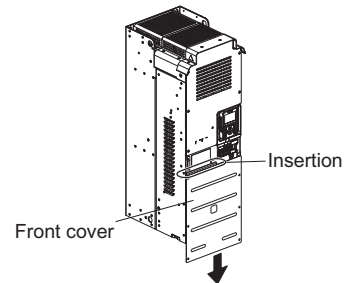

- 3 Mount the front cover in the reverse procedure.

■ **Transparent cover**

- 1 Remove the front cover.  
Refer to the procedure above.
- 2 Remove the tab that holds down the transparent cover, lift the transparent cover and remove it from the unit.

The transparent cover is just to be fitted in. It has no screw.

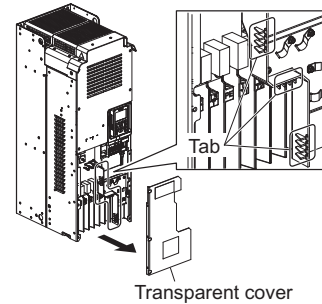

- 3 Mount the transparent cover in the reverse procedure.

■ **Wiring duct**

- 1 Remove the front cover and the transparent cover.  
Refer to the procedure above.

- 2 Remove two screws of the wiring duct.  
Store the removed screws so as not to be lost.
- 3 Remove one nut.  
Store the removed nut so as not to be lost.

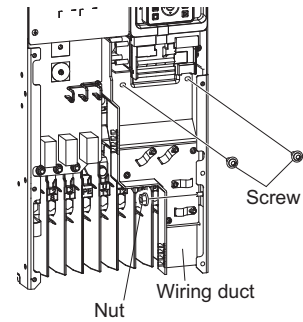

- 4 Lift the left side of the wiring duct first and remove it from the unit.  
Be careful that the bolt from which the nut has been removed does not get caught in the bolt hole.

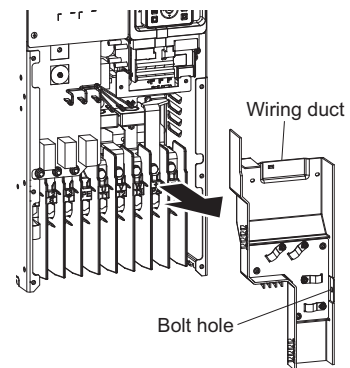

- 5 Mount the wiring duct in the reverse procedure.  
First, adjust the bolt hole to the position of the bolt.  
Be sure to mount the wiring duct before the transparent cover.

2

### 2. 2. 5 With frame size A7 and A8 VFAS3-4160KPC, VFAS3-4200KPC to 4280KPC

Here is a case of frame size A7.  
Except for its wider unit, frame size A8 has the same enclosure and structure as frame size A7.  
The parts to be removed are as follows.

- **Front cover (lower) on the lower side of the front surface (metal)**
- **Transparent cover inside the front cover above (transparent resin)**
- **Wiring duct inside the front cover above (white resin)**
- **DC reactor cover on the upper side of the front surface (metal mesh)**
- **Front cover (upper) in the middle of the front surface (metal)**

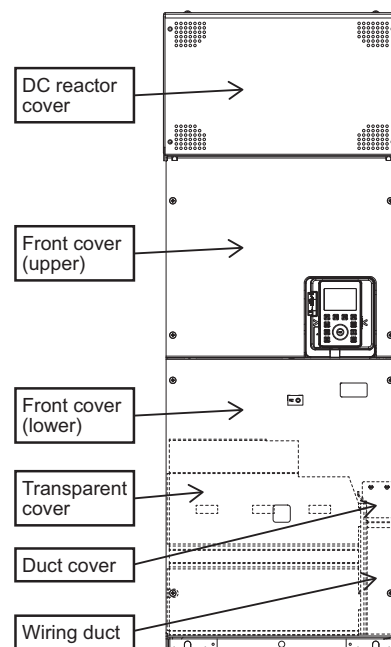

The DC reactor cover can be removed separately from the front cover.  
The top cover is never removed.

2

■ Front cover (lower)

- 1 Remove four screws of the front cover (lower).  
Store the removed screws so as not to be lost.
  
- 2 Lift the front cover (lower) and remove it from the unit.  
The upper side of the front cover (lower) has three tabs. If you lift them perpendicular to the cover, the cover can be removed without getting caught in the tabs.
  
- 3 Mount the front cover in the reverse procedure.

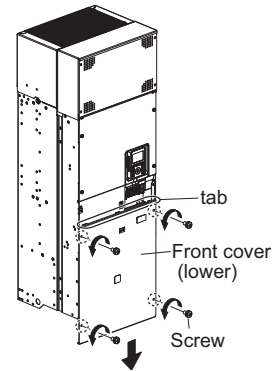

■ Transparent cover

- 1 Remove the front cover (lower).  
Refer to the procedure above.
  
- 2 Press and bend the wiring duct lightly by hand and remove two tabs on the right of the transparent cover from the fitting holes of the wiring duct.  
The tabs of the transparent cover are just fitted in.

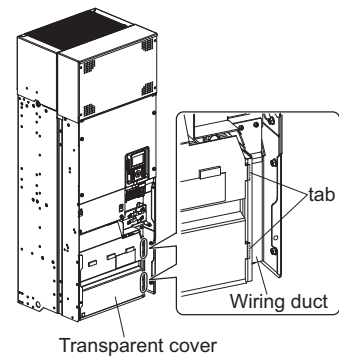

- 3 Lift the right side of the transparent cover first and remove it from the unit.  
The transparent cover is just fitted in and has no screw.  
Be careful that two bolt holes on the left side of the transparent cover do not get caught.

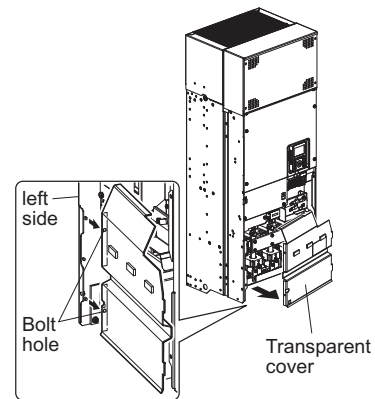

- 4 Mount the transparent cover in the reverse procedure.  
First, adjust the positions of two bolt holes and fit the cover in, then, fit two tabs on the right in the wiring duct.

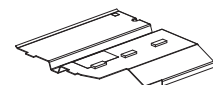

## ■ Wiring duct and Duct cover

- 1 Remove the front cover (lower) and the transparent cover.  
Refer to the procedure above.
  
- 2 Remove two screws of Duct cover.  
Store Duct cover and screws so as not to be lost.

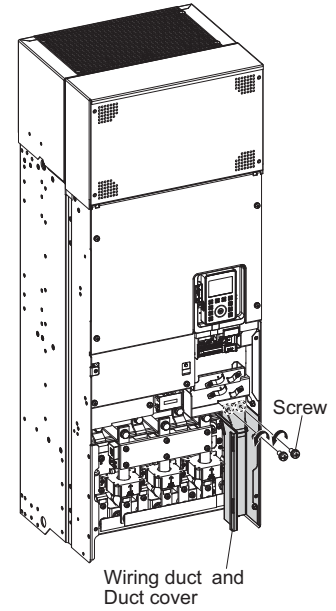

2

- 3 Remove two nuts of the wiring duct.  
Store the removed nuts so as not to be lost.

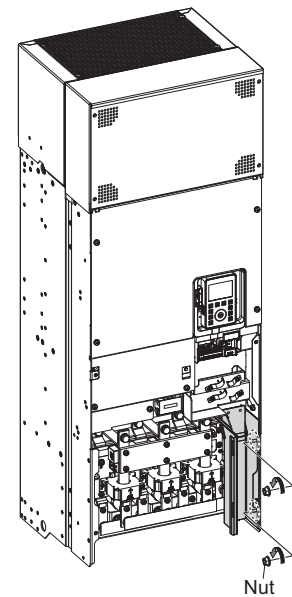

**2**

- 4 Remove the wiring duct from the unit by pulling it down.

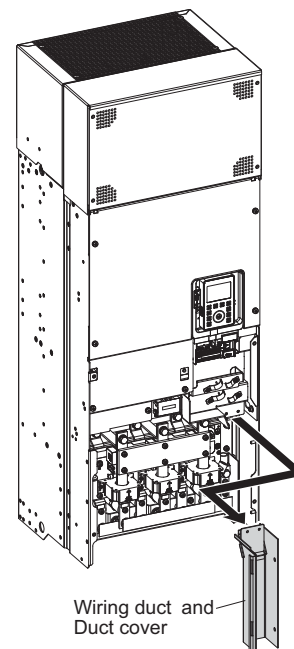

- 5 Mount Wiring duct and Duct cover in the reverse procedure.  
 First, insert the upper right part of the wiring duct to the unit. See the figure in step 4.  
 Be sure to mount the wiring duct before the transparent cover.

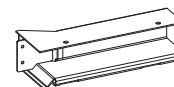

■ **DC reactor cover**

- 1 Remove four screws of the DC reactor cover.  
 Store the removed screws so as not to be lost.
- 2 Lift the lower end of the DC reactor cover slightly and remove it from the unit by pulling down.  
 The upper side of the DC reactor cover is to be inserted.
- 3 Mount the DC reactor cover in the reverse procedure.

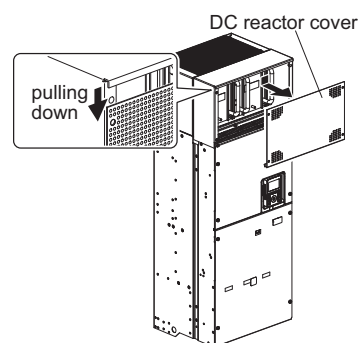
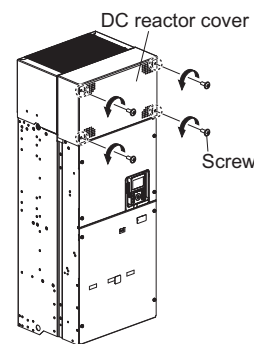

■ **Front cover (upper)**

- 1 Remove the front cover (lower) and the DC reactor cover.  
Refer to the procedure above.
- 2 Remove eight screws of the front cover (upper).  
Store the removed screws so as not to be lost.

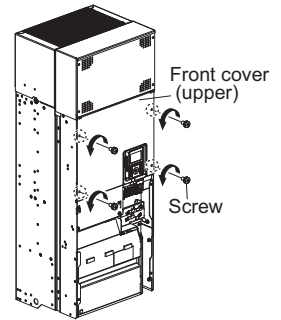

2

- 3 Lift the lower end of the front cover (upper) slightly, move the front cover (upper) slightly upward and unfasten two tabs of the unit.  
The upper end of the front cover (upper) is caught in two tabs of the unit.

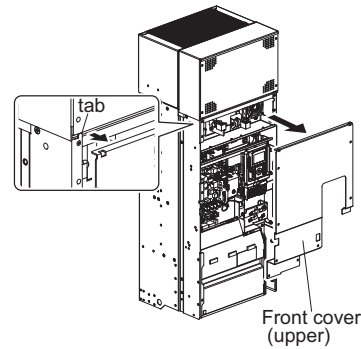

- 4 Lift the front cover (upper) and remove it from the unit.

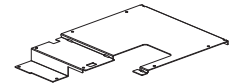

- 5 Mount the front cover (upper) in the reverse procedure.  
First, fit the upper end of the front cover (upper) in two tabs of the unit.  
Be sure to mount the front cover (upper) before the front cover (lower) and the DC reactor cover.

**2. 2. 6 Charge lamp**

While the charge lamp is on (red), voltage is applied, or high voltage remains in the inverter.  
The location of the charge lamp varies depending on the type.

■ **With frame size A1 to A5  
VFAS3-2004P to 2370P, VFAS3-4004PC to 4750PC**

The charge lamp is inside the front cover.

In the case of frame size A1, check the charge lamp in the following procedure. Also for other models, remove the front cover by referring to [2. 2] and check the charge lamp.

## 2

- 1 Loosen four screws of the front cover.  
Since the screws are of falling prevention type, they do not come off the front cover even if loosened.

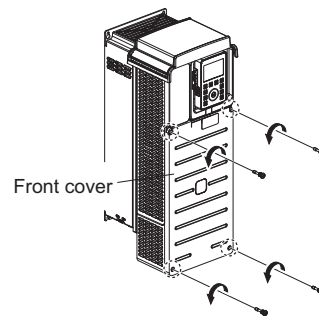

- 2 Hold the both side of the front cover and pull it slightly downward.  
The inserted part of the upper side of the front cover comes off.  
The tab shown in the figure on the right also come off.

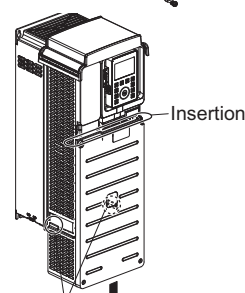

- 3 Pull the front cover toward you and remove it from the unit.

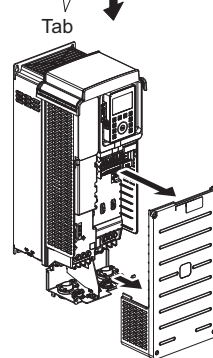

- 4 Check that the charge lamp is on/off.

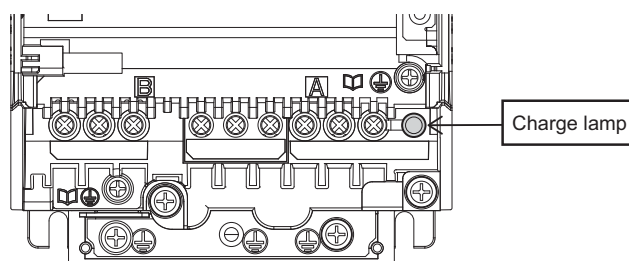

- 5 Mount the front cover in the reverse procedure.  
Pay attention to engagement of the tab and insertion of the upper side of the cover.



Frame size A2  
VFAS3-2037P, VFAS3-4055PC, 4075PC

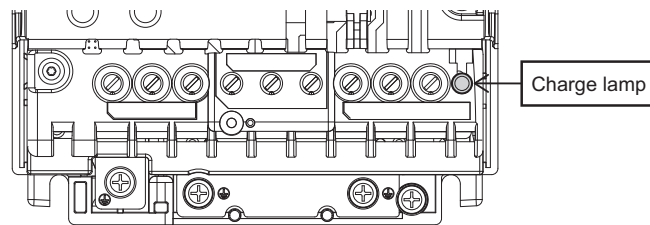

Frame size A3  
VFAS3-2055P, 2075P, VFAS3-4110PC to 4185PC

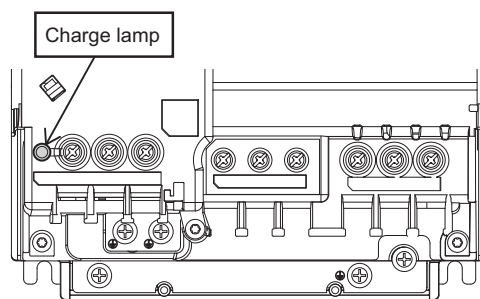

Frame size A4  
VFAS3-2110P to 2185P, VFAS3-4220PC to 4370PC

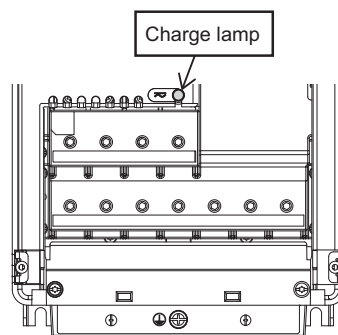

Frame size A5  
VFAS3-2220P to 2370P, VFAS3-4450PC to 4750PC

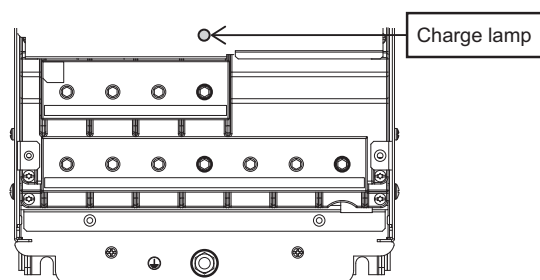

2



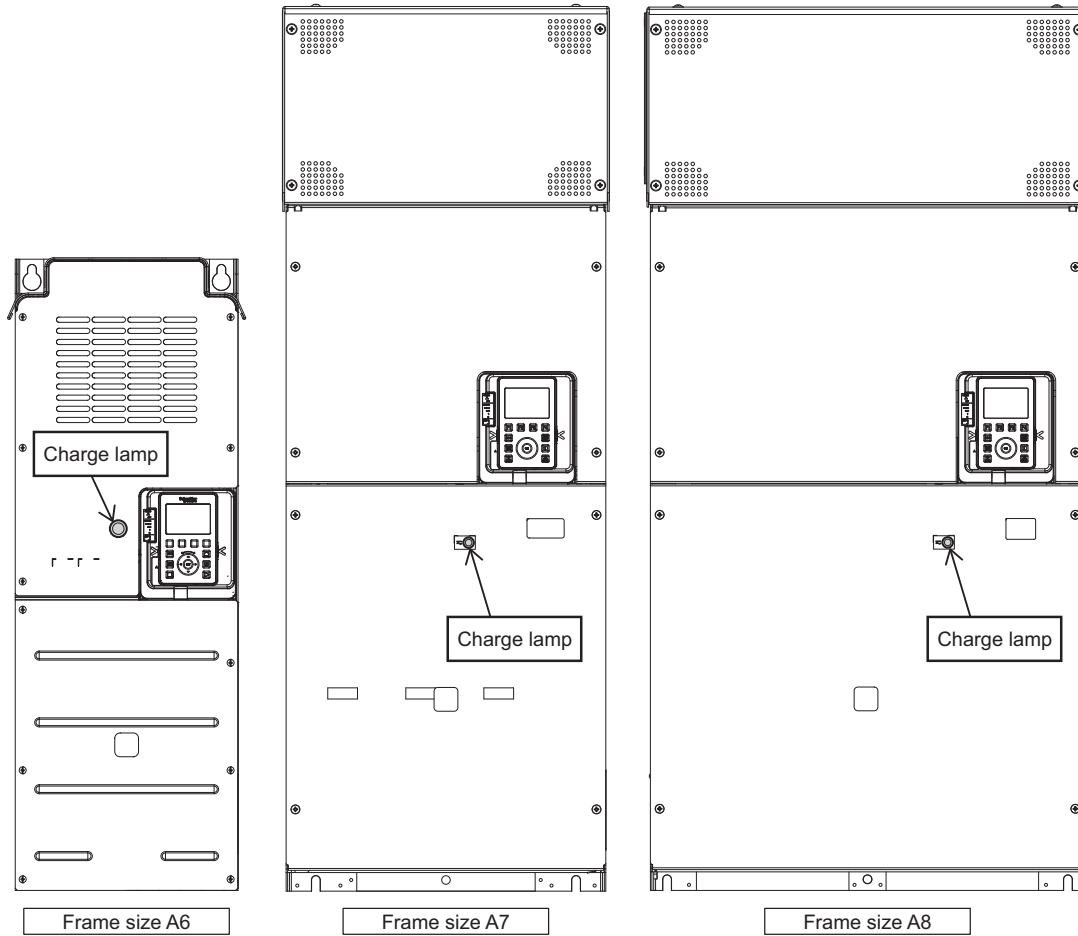

■ **With frame size A6 to A8**  
**VFAS3-2450P, 2550P, VFAS3-4900PC to 4280KPC**

You can check the charge lamp without opening the cover. When removing the front cover, be sure to check that the charge lamp is off.

**2**





## 2.3 Wiring

 <b>WARNING</b>	
 Disassembly prohibited	<ul style="list-style-type: none"> <li>• Never disassemble, modify or repair. This can result in electric shock, fire and other injury. Please call your Toshiba distributor for repairs.</li> </ul>
 Prohibited	<ul style="list-style-type: none"> <li>• Do not stick your fingers into openings such as cable wiring holes and cooling fan covers. The unit contains high voltage parts and contact with them will result in electric shock.</li> <li>• Do not place or insert any kind of object (electrical wire cuttings, rods, wires etc.) inside the inverter. This will cause a short circuit and result in electric shock or fire.</li> <li>• Do not allow water or any other fluids to come in contact with the inverter. This will cause a short circuit and result in electric shock or fire.</li> </ul>
 Mandatory action	<ul style="list-style-type: none"> <li>• All options to be used must be those specified by Toshiba. The use of options other than those specified by Toshiba will result in an accident.</li> <li>• In using a power distribution device and options for the inverter, they must be installed in a cabinet. When they are not installed in the cabinet, this will result in electric shock.</li> </ul>

2

This section explains cautions for wiring, how to connect to the power supply, motor, and control equipment, functions of the terminal blocks/connectors for communication, and how to switch the grounding capacitor, etc.

### 2.3.1 Cautions for wiring

 <b>WARNING</b>	
 Prohibited	<ul style="list-style-type: none"> <li>• Never remove the front cover when the power is on. The unit contains high voltage parts and contact with them will result in electric shock.</li> </ul>
 Mandatory action	<ul style="list-style-type: none"> <li>• Mount the front cover after wiring. If you turn the power on without attaching the front cover, this will result in electric shock or other injury.</li> <li>• Electrical construction work must be done by a qualified expert. Erroneous connection of power supply by someone who does not have that expert knowledge will result in fire or electric shock.</li> <li>• Connect output terminals (motor side) correctly. If the phase sequence is incorrect, the motor will operate in reverse and that can result in injury.</li> <li>• Wiring must be done after installation. If you perform wiring prior to installation, this will result in electric shock or other injury.</li> <li>• Verify that the power is turned off and the charge lamp is off before starting wiring. If you perform wiring without verification, this will result in electric shock.</li> <li>• Tighten the screws on the terminal block to specified torque. If the screws are not tightened sufficiently to the specified torque, this will result in fire.</li> <li>• Verify that the power supply voltage is within +10% and -15% (<math>\pm 10\%</math> when the load is 100% in continuous operation) of the applied power supply voltage written on the name plate. If you do not use the appropriate power supply voltage, this will result in failure or fire.</li> </ul>



Be grounded

- The grounding wire must be connected securely. If the grounding wire is not securely connected, when the inverter has failure or earth leakage, this will result in electric shock or fire.

CAUTION



Prohibited

- Do not attach devices with built-in capacitors (such as noise reduction filters or surge absorbers) to the output terminals (motor side). Heat rises up and this could cause a fire.



Mandatory action

- Following type of screwdriver should be used;  
Frame size A1 : PH2 (phillips, bit type2), shaft diameter 5.0mm or less  
Frame size A2 : PH2 (phillips, bit type2), shaft diameter 5.8mm or less

2

Pay attention to the following when wiring.

■ **Measures for noise**

To prevent electrical interference due to high-frequency noise generated by the inverter, separately bundle wires to the power circuit's power side terminals ([R/L1], [S/L2], [T/L3]) and wires to the motor side terminals ([U/T1], [V/T2], [W/T3]).

■ **Control power supply**



The control power of this inverter is supplied inside from the power circuit power supply. Therefore, if a malfunction or trip causes the power circuit to be shut off, control power will also be shut off.

- To check the cause of the malfunction or trip, set <F602: Trip record retention> to "1: Retain at power off."
- To make the control circuit continuously operate even if the power circuit is shut off due to malfunction or tripping, use an optional control power supply unit and supply power to the control circuit.

■ **Wiring**

- For power terminals, use ferrules with insulation sleeve terminal and crimp-style terminal with insulation sleeve. Connect the terminals so that adjacent terminals do not touch each other.
- For the sizes of electric wires used in the power circuit, refer to the table in [10. 1].
- The length of each wire is assumed to be 30 m or less. If the wire length is over 30 m, the wire size (diameter) must be increased.
- For grounding terminal, use wires of the size that is equivalent to or larger than those given in table [10. 1] and always ground the inverter.
- Wire the grounding wire as close as possible to the inverter.
- To ground the inverter unit, connect it to an exclusive grounding terminal. Do not use screws of the case, chassis, etc.
- Tighten the screws of the power terminal block and the control terminal block to the recommended tightening torque shown in the table [2. 3. 3] and [2. 3. 5] respectively.

### 2.3.2 Standard connection method

 <b>WARNING</b>	
 Prohibited	<ul style="list-style-type: none"> <li>Do not connect power supply to the output (motor side) terminals [U/T1], [V/T2] and [W/T3]. Connecting power supply to the output will damage the inverter and result in fire.</li> <li>Do not insert a braking resistor between DC terminals [PA/+] and [PC/-] or [PO] and [PC/-]. This will result in fire. Please connect the braking resistor in accordance with the instruction manual.</li> <li>Do not touch wires of equipment (e.g. ELCB) that is connected to the inverter power side at least 15 minutes after turning off the power. If an electric charge remains in a capacitor in the inverter, touching the wires before the indicated time will result in electric shock.</li> </ul>
 Be grounded	<ul style="list-style-type: none"> <li>The grounding wire must be connected securely. If the grounding wire is not securely connected, when the inverter has failure or earth leakage, this will result in electric shock or fire.</li> </ul>

2

The wiring of the power supply and motor is connected to the power terminal block and the wiring of external control equipment such as control signals to the control terminal block.

#### ■ Connection to power supply and motor

This diagram shows a standard wiring of the power circuit.

Connection to the power supply and motor wiring is common to all the types.

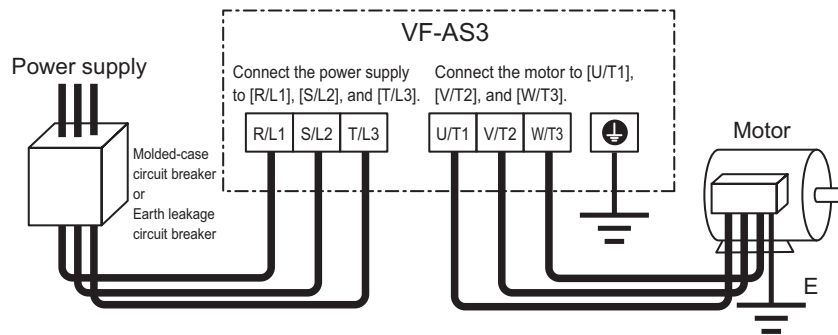

#### ■ Connection to peripheral devices

This diagram shows an example of connection to peripheral devices.

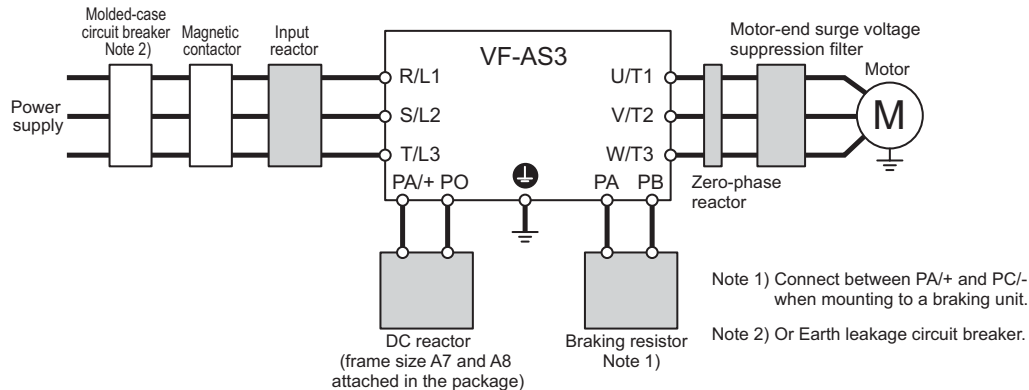

For details of the peripheral devices, refer to [Chapter 10].

- An noise filter is built in all the types as standard.
- A DC reactor is built in as standard or attached (frame size A7, A8).

#### Braking resistor

- To VFAS3-2004P to 2370P, VFAS3-4004PC to 4750PC, and VFAS3-4160KPC, connect only the braking resistor (optional) because a dynamic braking circuit is built in them as standard.
- When a braking resistor (optional) is installed for VFAS3-4900PC to 4132KPC and VFAS3-4200KPC to 4280KPC, a braking unit (optional) is also required.

For details, refer to [10. 3. 2].

#### DC input

- To input DC power, connect the inverter between terminals [PA/+] and [PC/-].
- When VFAS3-2110P to VFAS3-2550P or VFAS3-4220PC to VFAS3-4280KPC are used with a DC power supply, a circuit to suppress an inrush current should be required.
- When VFAS3-4160KPC to 4280KPC are used with a DC power supply, three-phase power input for cooling fan driving should be prepared separately.

For details, refer to application manual "DC power supply connect to inverter" (E6582156).

### ■ Connection procedure of power circuit wiring

The following is the connection procedure of the power connection, with frame size A1 as an example.

Connect other sizes in the same way.

- 1 Remove the front cover.  
For how to remove, refer to [2. 2. 1].
- 2 Loosen the screws of the grounding terminal for inverter case. Mount the grounding wire to the screws of grounding terminal. Switch the grounding capacitor when needed. For details of how to switch, refer to [2. 3. 4].
- 3 Loosen the screws of the terminals [U/T1], [V/T2], and [W/T3] and a terminal [PE] of the power terminal block.  
The terminal [PE] exists only in frame size A4 to A6.

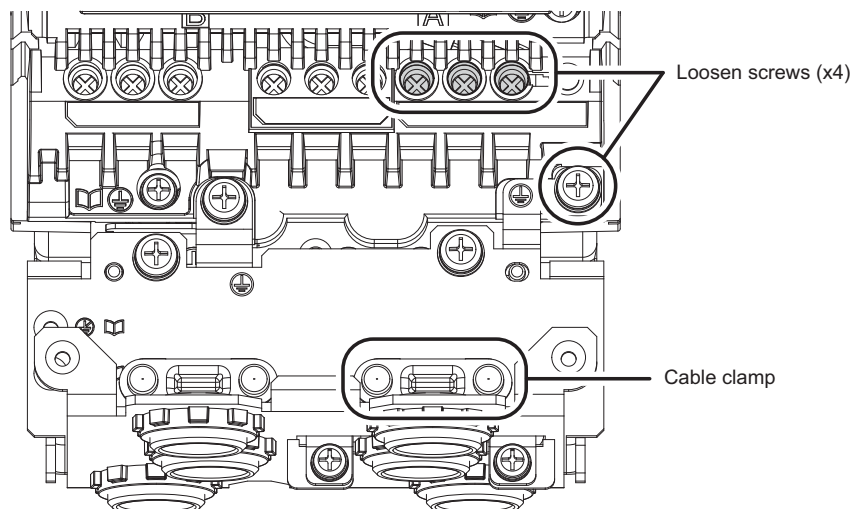

- 4 Pass the motor wiring through the cable clamp.  
The cable clamp exists only in frame size A1 to A5.
  
- 5 Mount the motor wiring to the screw of each corresponding terminal.  
Mount ferrules with insulation sleeve terminal and crimp-style terminal with insulation sleeve to the end of each wire of the motor in advance. For cautions, refer to "■Wiring" of [2. 3. 1].

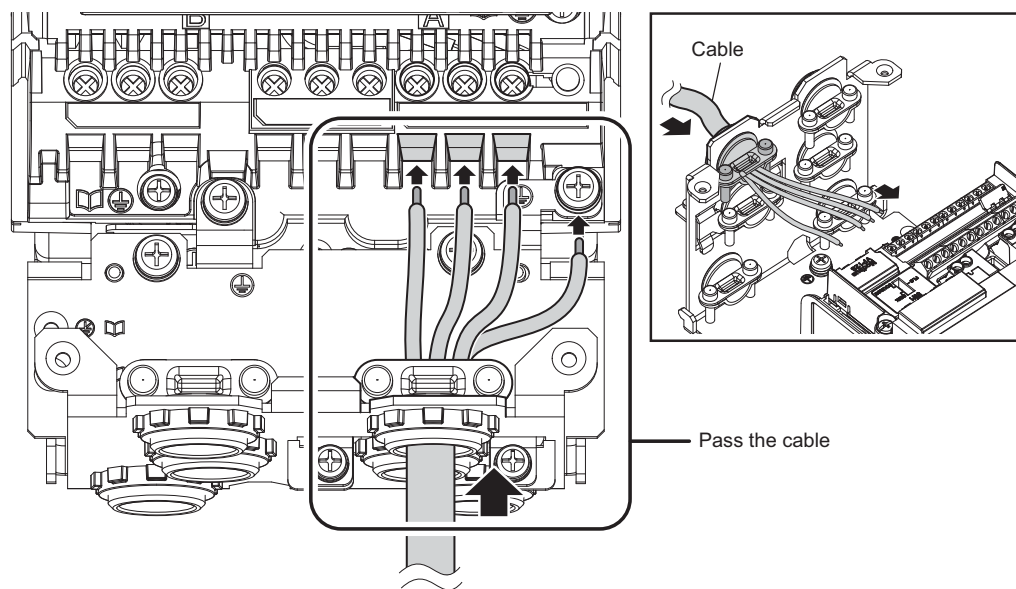

2

- 6 Tighten the screws of the terminals [U/T1], [V/T2], and [W/T3] and a terminal [PE].  
For the recommended tightening torque, refer to "■Recommended tightening torque of power terminal screws" of [2. 3. 3].

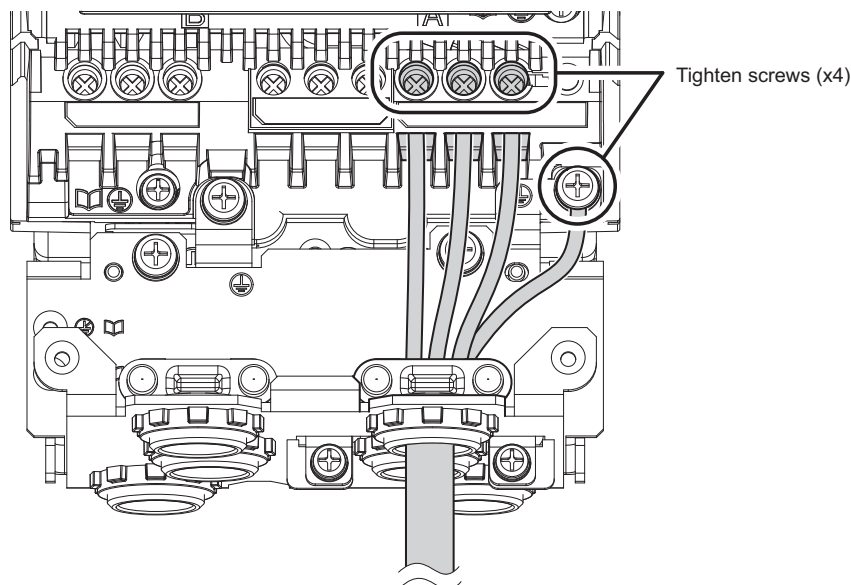

**2**

- 7 Tighten two screws of the cable clamp and fix the motor wiring (four wires) with the cable clamp.  
The cable clamp exists only in frame size A1 to A5.

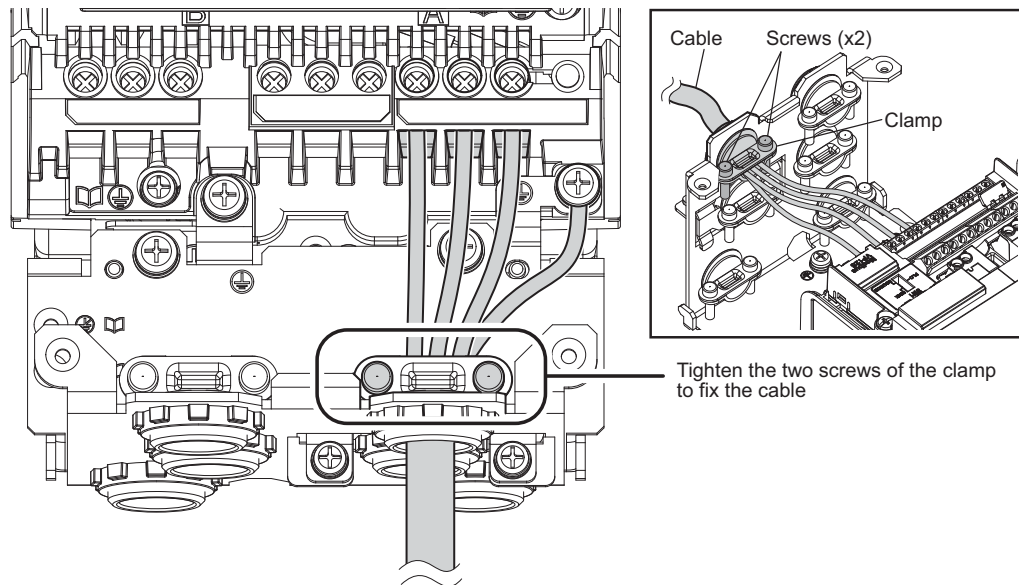

- 8 Similarly, mount the power supply wiring to the terminals [R/L1], [S/L2], and [T/L3] and a terminal [PE] after passing it through other cable clamp.  
For the recommended tightening torque of the screws, refer to "■Recommended tightening torque of power terminal screws" of [2. 3. 3].  
Also fix the power supply wiring with the cable clamp.  
The cable clamp exists only in frame size A1 to A5.

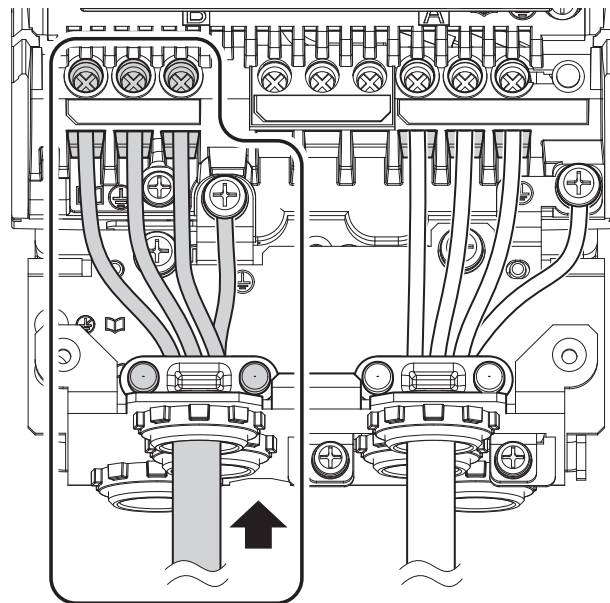

- 9 When connection is complete, mount the front cover.  
For how to mount, refer to [2. 2. 1].



**Memo**

- For the layout and shape of power terminal block of each frame size, refer to [2. 3. 3].
- The cable clamp exists only in frame size A1 to A5.
- Covers to be removed at the time of wiring vary depending on the frame size. For details, refer to [2. 2].

**■ Connection of control circuit**

- The input/output of the control circuit consist of digital input x 8 points, analog input x 3 points, analog output x 2 points, relay contact output x 3 points, etc. In many cases, the function of input/output can be switched with parameter setting.
- For the function and electrical specification of each terminal, refer to [2. 3. 5].
- For details of how to operate with terminal input, refer to [4. 4].

For an example of wiring of the control circuit, refer to the "■Standard connection diagram".

**■ Standard connection diagram**

This diagram shows a standard wiring of the power circuit and control circuit.

[Standard connection diagram - Sink]

This diagram shows an example of a standard connection for 240 V class, 0.4 to 37kW and 480 V class, 0.4 to 75kW (frame size A1 to A5).

Power supply

- 240 V class:  
0.4 - 37 kW Three-phase 200 - 240 V-50/60 Hz
- 480 V class:  
0.4 - 75kW Three-phase 380 - 480 V-50/60 Hz

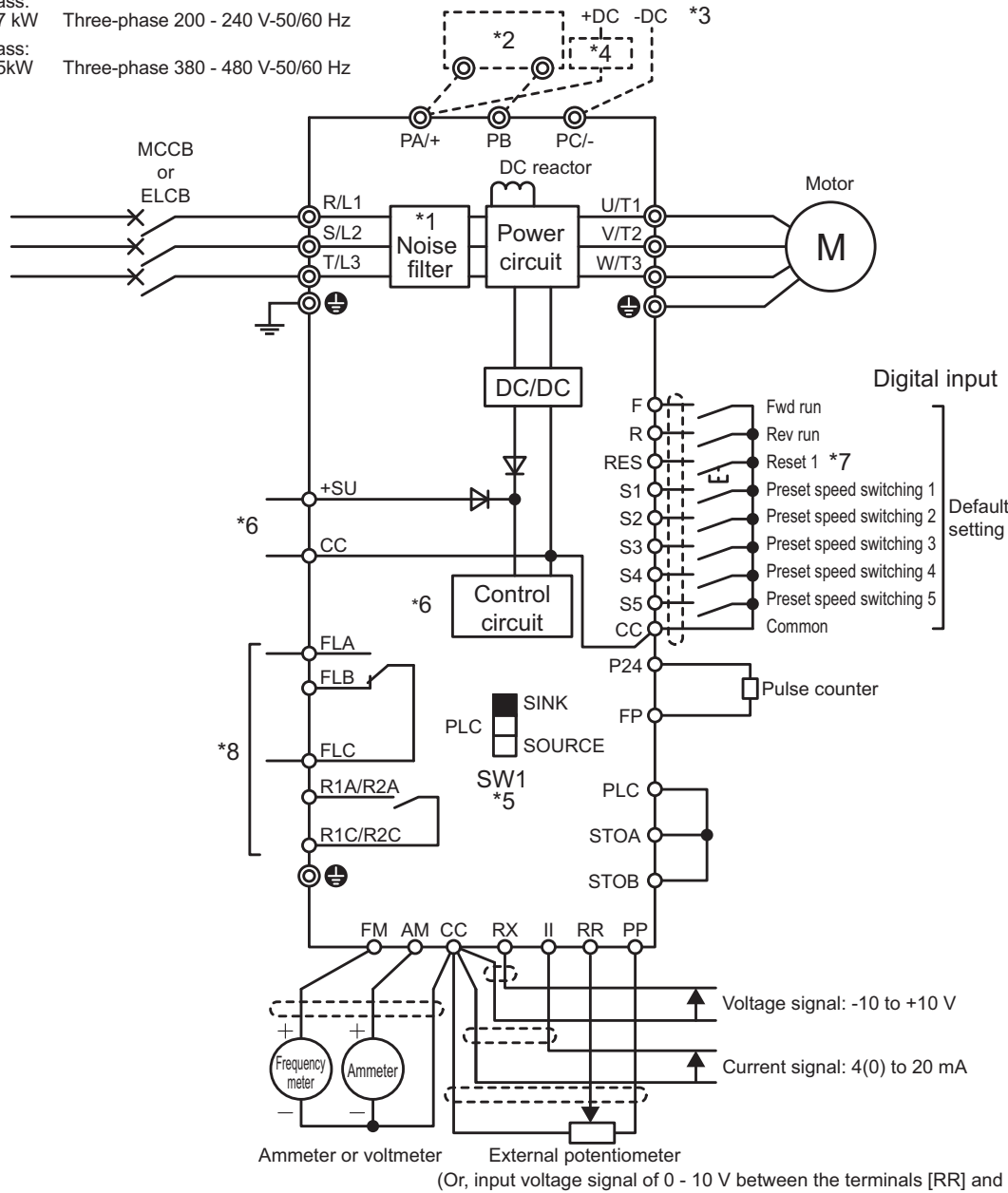

- \*1 EMC filter is built in 480 V class.
- \*2 External braking resistor (option).
- \*3 To input DC power, connect the inverter between the terminals [PA/+] and [PC/-].
- \*4 If your inverter is 240 V with 11kW or more, or 480 V with 22kW or more. when using it with a DC power supply, a circuit to suppress an inrush current is required. For detail, refer to application manual "DC power supply connect to inverter" (E6582156).
- \*5 For the switch function, refer to [2. 3. 5].
- \*6 To supply control power from an external power supply for backing up the control power supplied from the inverter, an optional control power supply unit (CPS002Z) is required. In this case, it is used in conjunction with the inverter internal power supply. Set <F647: Control power option failure detection> to back up the control power supply. For details, refer to [6. 30. 20].
- \*7 The reset signal is activated by ON→OFF trigger input.
- \*8 Connect to power to comply with OVC2 (Over Voltage Category 2). Isolation transformer is necessary when connecting to power supply (OVC3).

2

[Standard connection diagram - Sink]

This diagram shows an example of a standard connection for 240 V class, 45 - 55 kW and 480 V class, 90 - 132 kW (frame size A6).

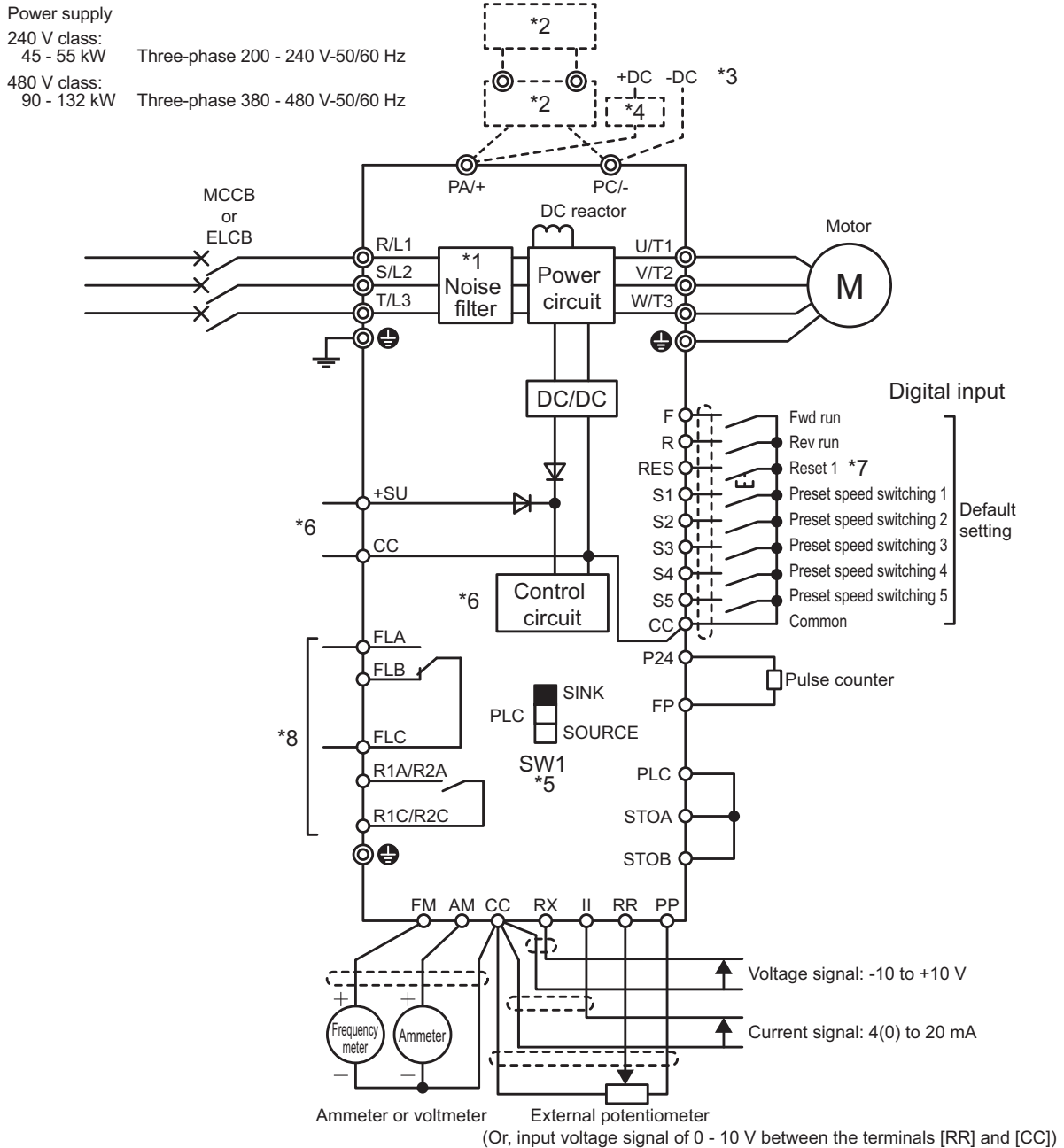

- \*1 EMC filter is built in 480 V class.
- \*2 When a braking resistor (optional) is mounted, a braking unit (optional) is also required.
- \*3 To input DC power, connect the inverter between the terminals [PA/+] and [PC/-].
- \*4 When the inverter is used with a DC power supply, a circuit to suppress an inrush current should be required. For detail, refer to application manual "DC power supply connect to inverter" (E6582156).
- \*5 For the switch function, refer to [2. 3. 5].
- \*6 To supply control power from an external power supply for backing up the control power supplied from the inverter, an optional control power supply unit (CPS002Z) is required. In this case, it is used in conjunction with the inverter internal power supply. Set <F647: Control power option failure detection> to back up the control power supply. For details, refer to [6. 30. 20].
- \*7 The reset signal is activated by ON→OFF trigger input.
- \*8 Connect to power to comply with OVC2 (Over Voltage Category 2). Isolation transformer is necessary when connecting to power supply (OVC3).

[Standard connection diagram - Sink]

This diagram shows an example of a standard connection for 480 V class, 160 kW (frame size A7).

Power supply

480 V class:  
160 kW Three-phase 380 - 440 V-50 Hz  
Three-phase 380 - 480 V-60 Hz

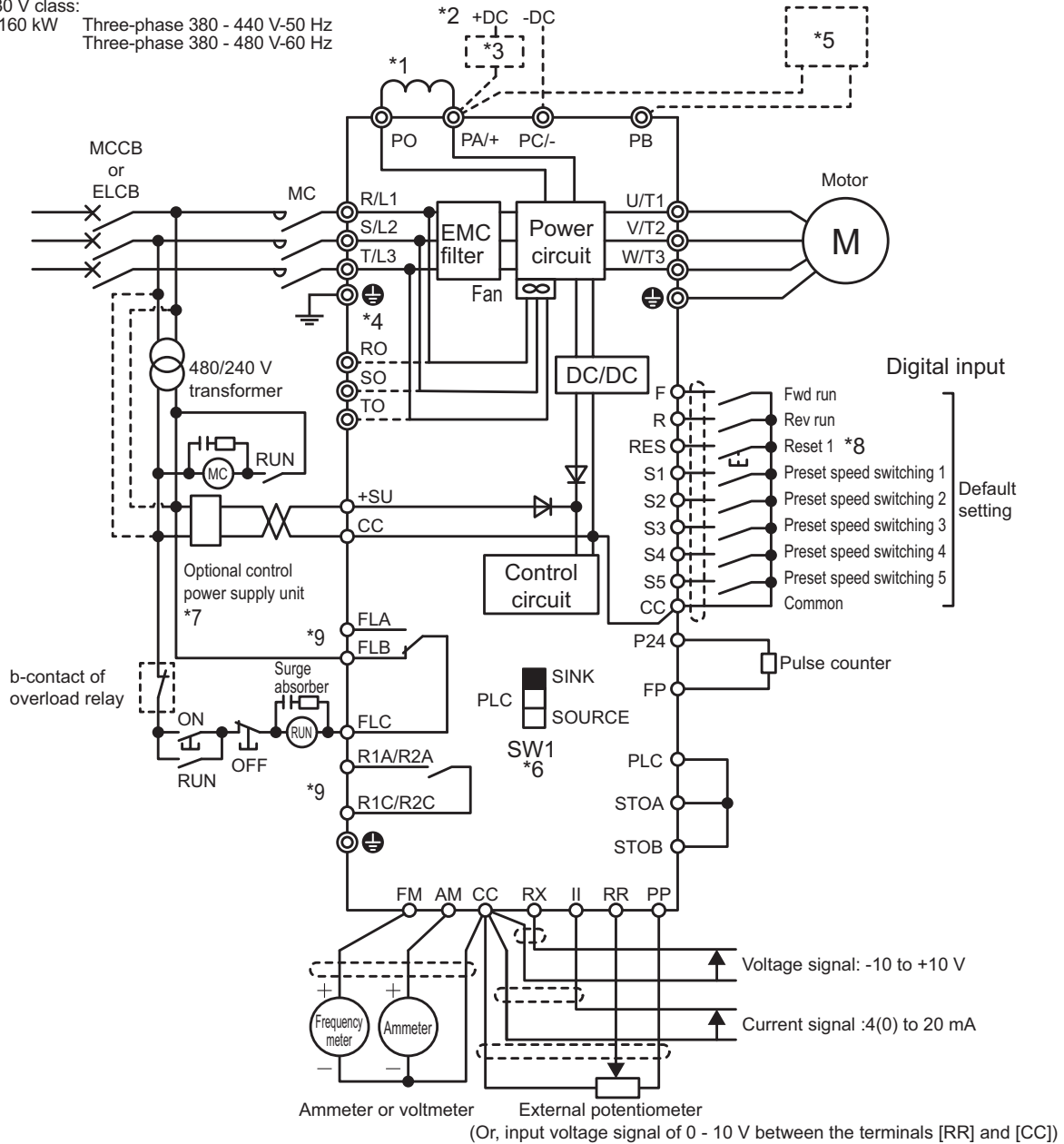

- \*1 Be sure to mount the DC reactor. A circuit between the terminals [PA/+ ] and [PO] is not short circuited (at the time of shipping).
- \*2 To input DC power, connect the inverter between the terminals [PA/+ ] and [PC/-].
- \*3 When the inverter is used with a DC power supply, a circuit to suppress an inrush current should be required. For detail, refer to application manual "DC power supply connect to inverter" (E6582156).
- \*4 When the inverter is used with a DC power supply, three-phase power input for cooling fan driving is required separately. For details, refer to application manual "DC power supply connect to inverter" (E6582156).
- \*5 External braking resistor (option)
- \*6 For the switch function, refer to [2. 3. 5].
- \*7 To supply control power from an external power supply for backing up the control power supplied from the inverter, an optional control power supply unit (CPS002Z) is required. In this case, it is used in conjunction with the inverter internal power supply. Set <F647: Control power option failure detection> to back up the control power supply. For details, refer to [6. 30. 20].
- \*8 The reset signal is activated by ON→OFF trigger input.
- \*9 Connect to power to comply with OVC2 (Over Voltage Category 2). Isolation transformer is necessary when connecting to power supply (OVC3).

[Standard connection diagram - Sink]

This diagram shows an example of a standard connection for 480 V class, 200 to 280 kW (frame size A8).

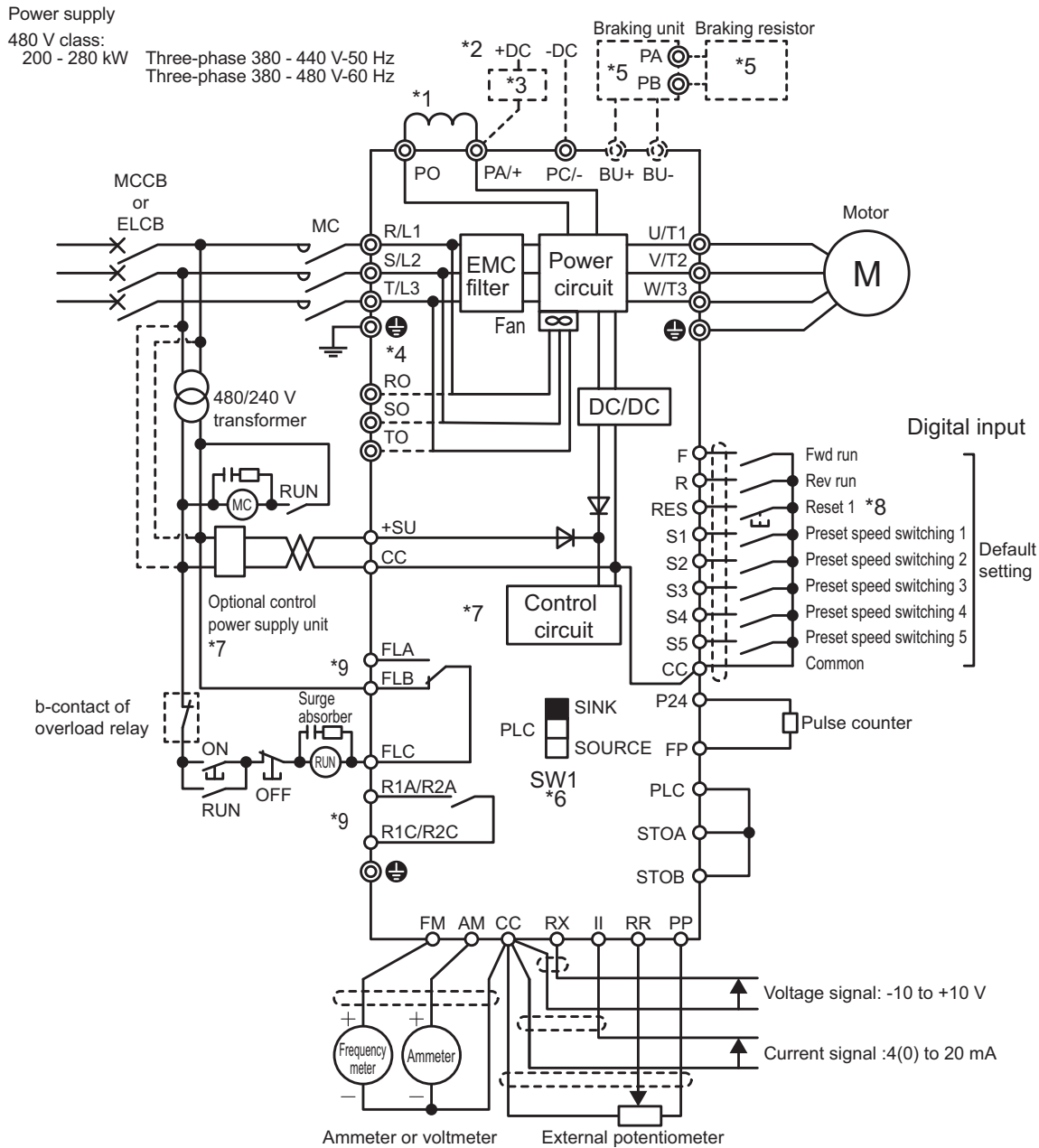

2

- \*1 Be sure to mount the DC reactor. It is not required for DC power input terminal. A circuit between the terminals [PA/+] and [PO] is not short circuited (at the time of shipping).
- \*2 To input DC power, connect the inverter between the terminals [PA/+] and [PC/-]. It is not used in conjunction with the DC reactor option DCL1.
- \*3 When the inverter is used with a DC power supply, a circuit to suppress an inrush current is required. For detail, refer to application manual "DC power supply connect to inverter" (E6582156).
- \*4 When the inverter is used with a DC power supply, three-phase power input for cooling fan driving is required separately. For details, refer to application manual "DC power supply connect to inverter" (E6582156).
- \*5 When a braking resistor (optional) is mounted, a braking unit (optional) is also required.
- \*6 For the switch function, refer to [2. 3. 5].
- \*7 To supply control power from an external power supply for backing up the control power supplied from the inverter, an optional control power supply unit (CPS002Z) is required. In this case, it is used in conjunction with the inverter internal power supply. Set <F647: Control power supply option failure detection> to back up the control power supply. For details, refer to [6. 30. 20].
- \*8 The reset signal is activated by ON→OFF trigger input.
- \*9 Connect to power to comply with OVC2 (Over Voltage Category 2). Isolation transformer is necessary when connecting to power supply (OVC3).

[Standard connection diagram - Source]

This diagram shows an example of a standard connection for 240 V class, 0.4 to 37 kW and 480 V class, 0.4 to 75 kW (frame size A1 to A5).

Power supply

240 V class:  
0.4 - 37 kW Three-phase 200 - 240 V-50/60 Hz

480 V class:  
0.4 - 75kW Three-phase 380 - 480 V-50/60 Hz

2

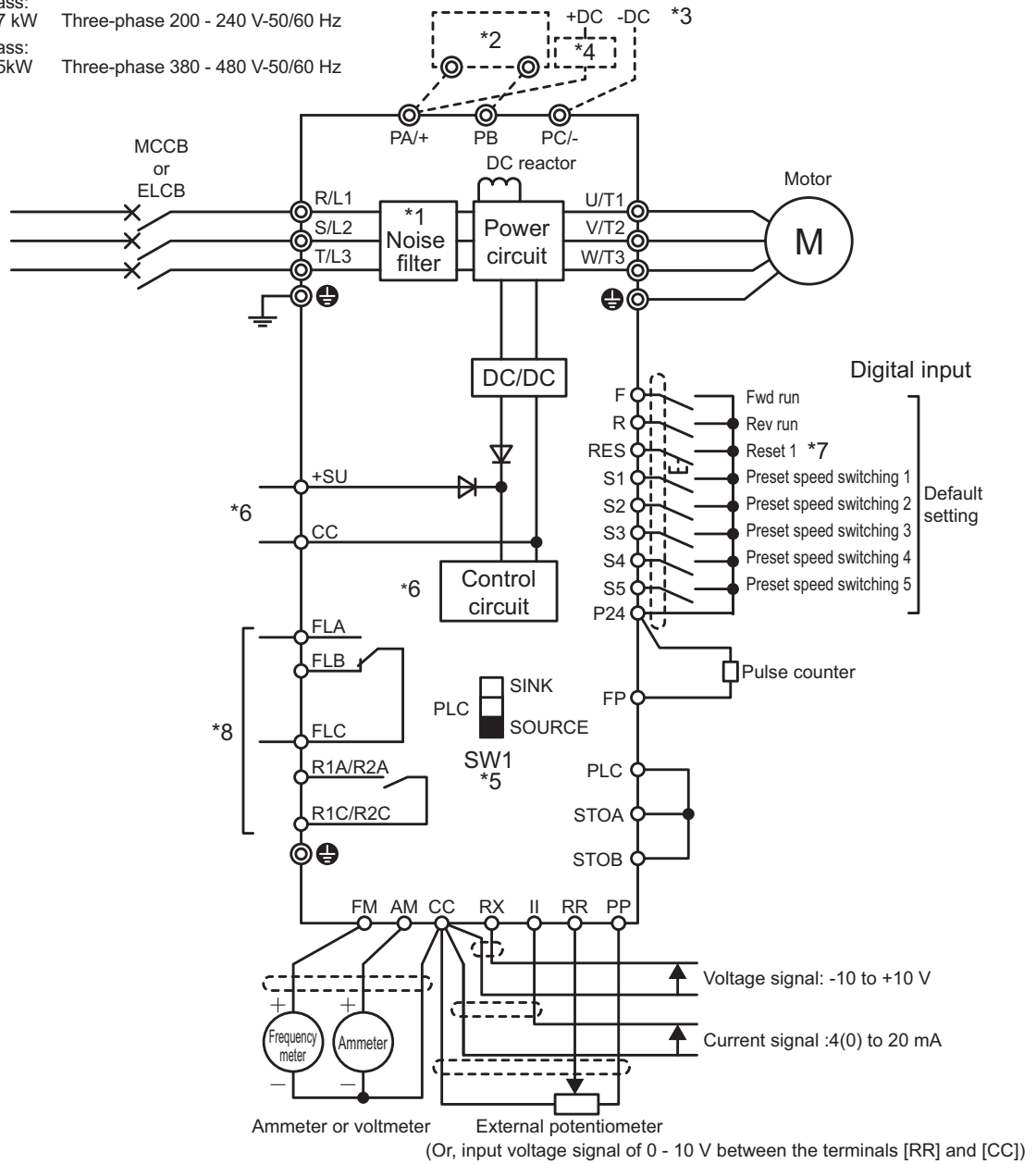

- \*1 EMC filter is built in 480 V class.
- \*2 External braking resistor (option).
- \*3 To input DC power, connect the inverter between the terminals [PA/+] and [PC/-].  
When your inverter is VFAS3-2110P to VFAS3-2370P or VFAS3-4220PC to VFAS3-4750PC, a circuit to suppress an inrush current is required. For detail refer to application manual "DC power supply connect to inverter" (E6582156).
- \*5 For the switch function, refer to [2. 3. 5].
- \*6 To supply control power from an external power supply for backing up the control power supplied from the inverter, an optional control power supply unit (CPS002Z) is required. In this case, it is used in conjunction with the inverter internal power supply.  
Set <F647: Control power option failure detection> to back up the control power supply.  
For details, refer to [6. 30. 20].
- \*7 The reset signal is activated by ON→OFF trigger input.
- \*8 Connect to power to comply with OVC2 (Over Voltage Category 2). Isolation transformer is necessary when connecting to power supply (OVC3).

[Standard connection diagram - Source]

This diagram shows an example of a standard connection for 240 V class, 45 to 55 kW and 480 V class, 90 to 132 kW (frame size A6).

Power supply

240 V class:  
45 - 55 kW Three-phase 200 - 240 V-50/60 Hz

480 V class:  
90 - 132 kW Three-phase 380 - 480 V-50/60 Hz

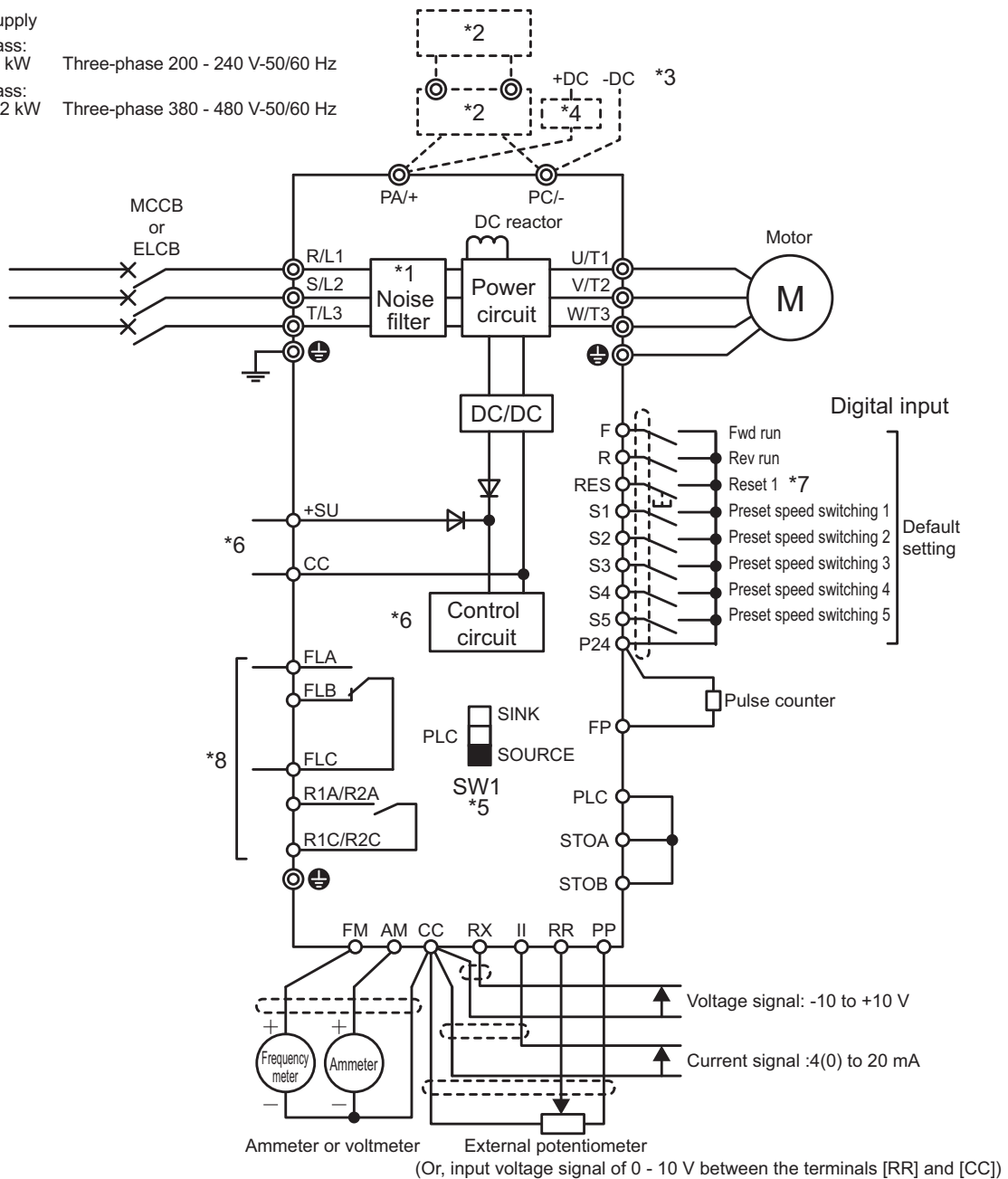

- \*1 EMC filter is built in 480 V class.
- \*2 When a braking resistor (optional) is mounted, a braking unit (optional) is also required.
- \*3 To input DC power, connect the inverter between the terminals [PA/+] and [PC/-].
- \*4 When the inverter is used with a DC power supply, a circuit to suppress an inrush current is required. For detail, refer to application manual "DC power supply connect to inverter" (E6582156).
- \*5 For the switch function, refer to [2. 3. 5].
- \*6 To supply control power from an external power supply for backing up the control power supplied from the inverter, an optional control power supply unit (CPS002Z) is required. In this case, it is used in conjunction with the inverter internal power supply. Set <F647: Control power option failure detection> to back up the control power supply. For details, refer to [6. 30. 20].
- \*7 The reset signal is activated by ON→OFF trigger input.
- \*8 Connect to power to comply with OVC2 (Over Voltage Category 2). Isolation transformer is necessary when connecting to power supply (OVC3).

[Standard connection diagram - Source]

This diagram shows an example of a standard connection for 480 V class, 160 kW (frame size A7).

Power supply

480 V class:  
160 kW Three-phase 380 - 440 V-50 Hz  
Three-phase 380 - 480 V-60 Hz

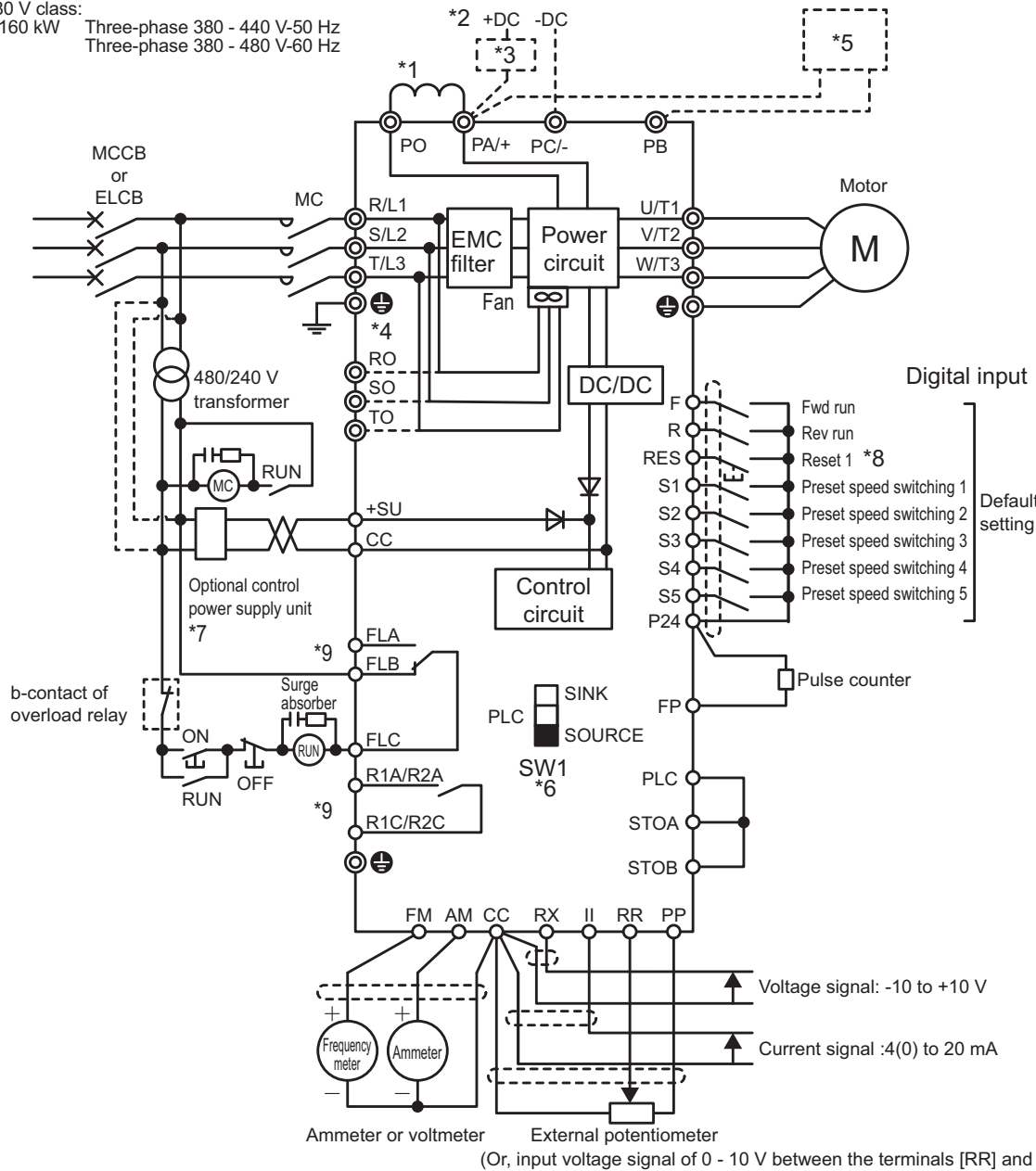

- \*1 Be sure to mount the DC reactor. A circuit between the terminals [PA/+] and [PO] is not short circuited (at the time of shipping).
- \*2 To input DC power, connect the inverter between the terminals [PA/+] and [PC/-].
- \*3 When the inverter is used with a DC power, a circuit to suppress an inrush current should be required. For detail, refer to application manual "DC power supply connect to inverter" (E6582156).
- \*4 When the inverter is used with a DC power supply, three-phase power input for cooling fan driving is required separately. For details, refer to application manual "DC power supply connect to inverter" (E6582156).
- \*5 External braking resistor (option)
- \*6 For the switch function, refer to [2. 3. 5].
- \*7 To supply control power from an external power supply for backing up the control power supplied from the inverter, an optional control power supply unit (CPS002Z) is required. In this case, it is used in conjunction with the inverter internal power supply. Set <F647: Control power option failure detection> to back up the control power supply. For details, refer to [6. 30. 20].
- \*8 The reset signal is activated by ON→OFF trigger input.
- \*9 Connect to power to comply with OVC2 (Over Voltage Category 2). Isolation transformer is necessary when connecting to power supply (OVC3).

2



[Standard connection diagram - Source]

This diagram shows an example of a standard connection for 480 V class, 200 to 280 kW (frame size A8).

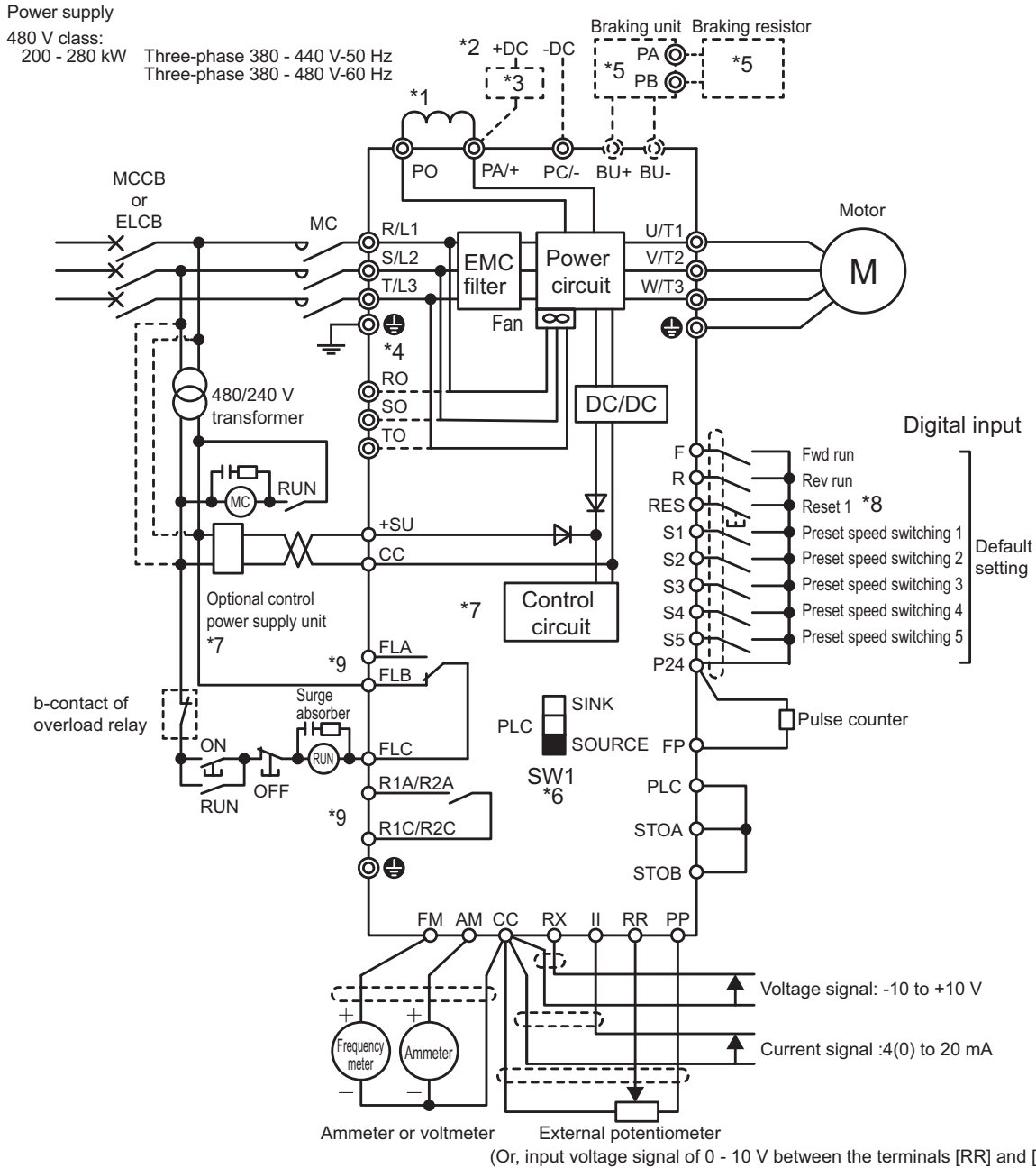

- \*1 Be sure to mount the DC reactor. It is not required for DC power input terminal. A circuit between the terminals [PA/+] and [PO] is not short circuited (at the time of shipping).
- \*2 To input DC power, connect the inverter between the terminals [PA/+] and [PC/-]. It is not used in conjunction with the DC reactor option DCL1.
- \*3 When the inverter is used with a DC power supply, a circuit to suppress an inrush current is required. For detail, refer to application manual "DC power supply connect to inverter" (E6582156).
- \*4 When the inverter is used with a DC power supply, three-phase power input for cooling fan driving is required separately. For details, refer to application manual "DC power supply connect to inverter" (E6582156).
- \*5 If a braking resistor (optional) is mounted, a braking unit (optional) is also required.
- \*6 For the switch function, refer to [2. 3. 5].
- \*7 To supply control power from an external power supply for backing up the control power supplied from the inverter, an optional control power supply unit (CPS002Z) is required. In this case, it is used in conjunction with the inverter internal power supply.
- \*8 The reset signal is activated by ON→OFF trigger input.
- \*9 Connect to power to comply with OVC2 (Over Voltage Category 2). Isolation transformer is necessary when connecting to power supply (OVC3).

### 2. 3. 3 Power terminals

The power terminals are connected to the power supply (primary side) and the motor (secondary side).

■ Functions of power terminals

2

Terminal symbol	Function	Applicable frame size
	Grounding terminal for inverter case. There are 3 terminals in cooling fin or mounting part of EMC plate.	All frame sizes
[PE]	Grounding terminal.	Frame size A4, A5, and A6
[R/L1] [S/L2] [T/L3]	Connected to an AC power supply. 240 V class: Three-phase 200 - 240 V-50/60 Hz 480 V class: VFAS3-4004PC to 4132KPC : Three-phase 380 - 480 V-50/60 Hz VFAS3-4160KPC to 4280KPC : Three-phase 380 - 440 V- 50 Hz Three-phase 380 - 480 V- 60 Hz	All frame sizes
[U/T1] [V/T2] [W/T3]	Connected to a three-phase motor.	All frame sizes
[PA/+] [PB]	Connected to a braking resistor. Change the parameters <F304: Dynamic braking, OLr trip>, <F308: Braking resistance>, and <F309: Braking resistor capacity> if necessary.	Frame size A1, A2, A3, A4, A5, and A7
[BU/+] [BU/-]	Inside the inverter. Connected to a braking unit (optional). Braking resistor (optional) is connected to a braking unit terminals [PA] and [PB].	Frame size A8
[PA/+] [PC/-]	A DC power can be input. For models of VFAS3-2110P to 2550P and VFAS3-4220PC to 4280KPC, a rush current suppression circuit (optional) is required. Connected to a braking unit (Optional) for frame size A6. Supply AC power supply to cooling fans if you use VFAS3-4160KPC - 4280KPC with DC input.	All frame sizes
[PA/+] [P0]	Be sure to connect the attached DC reactor.	Frame sizes A7 and A8
[R0] [S0] [T0]	Supply AC power supply for cooling fans if you use VFAS3-4160KPC - 4280KPC with DC input.	Frame sizes A7 and A8

<b>Memo</b>	<ul style="list-style-type: none"> <li>The arrangement of the terminals varies depending on the type. See the figures on the next page and after.</li> </ul>
-------------	--

■ **Recommended tightening torque of power terminal screws**

**Power terminal torque and wire strip length**

Screw size	Frame size	Torque		Strip length (mm)	Cable size
		(N · m)	(lb · in)		
M4	A1	1.3	11.5	10	-
	A2	1.5	13.3	10	-
M5	A3	2.6	23	18	-
M8	A4	5.0	44.3	28	AWG2 or smaller
		10	88.5	28	AWG1 or bigger
M10	A6	27	239	-	-
M12	A5	10	88.5	35	AWG1/0 or smaller
		18	159	35	AWG2/0 or bigger
M12	A7/A8	41	360	-	-
M10	A7	24	212	-	-
M4	A7/A8	1.4	12.4	-	-

2

**Grounding terminal torque**

Screw size	Frame size	Torque		Strip length (mm)	Cable size
		(N · m)	(lb · in)		
M5	A1,A2,A3	2.6	23	-	-
M6	A4	4.4	38.9	-	-
M8	A4	5.0	44.3	28	AWG2 or smaller
		10	88.5	28	AWG1 or bigger
M8	A5,A6	11.8	104	-	-
M10	A6	27	239	-	-
M12	A5	10	88.5	35	AWG1/0 or smaller
		18	159	35	AWG2/0 or bigger
M12	A7/A8	41	360	-	-
M10	A7	24	212	-	-

Note) 1(N · m) = 8.850(lb · in)

■ Arrangement of power terminals

1) Frame size A1

VFAS3-2004P to 2022P, VFAS3-4004PC to 4037PC

2

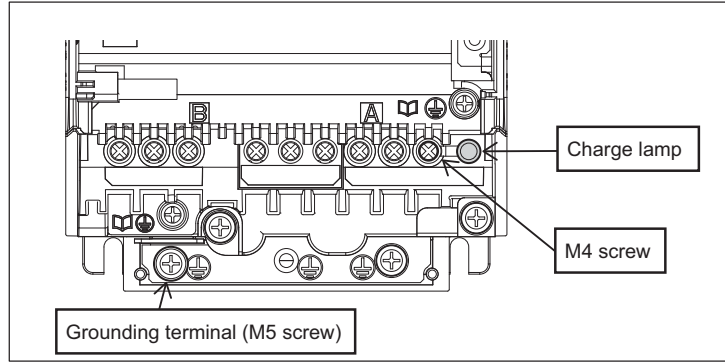
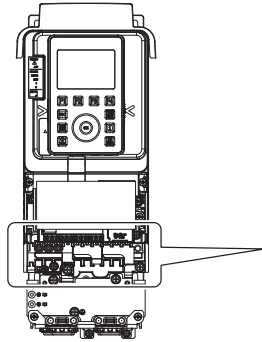

**! CAUTION**



Mandatory action

- Following type of screwdriver should be used for M4 screw;  
PH2 (phillips, bit type2), shaft diameter 5.0 mm or less.

2) Frame size A2

VFAS3-2037P, VFAS3-4055PC, 4075PC

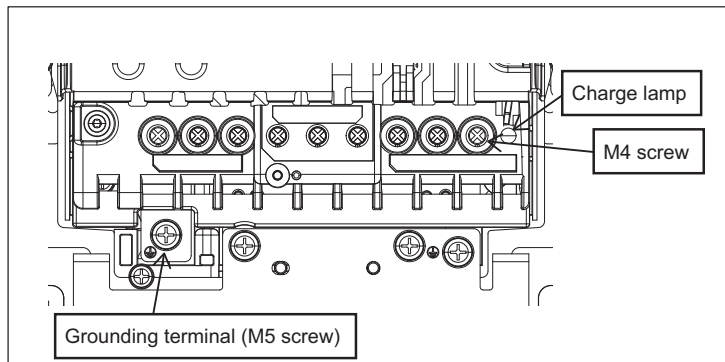
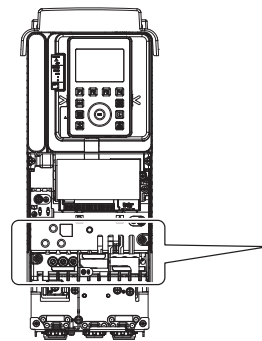

**! CAUTION**



Mandatory action

- Following type of screwdriver should be used for M4 screw;  
PH2 (phillips, bit type2), shaft diameter 5.8 mm or less

**3) Frame size A3**  
**VFAS3-2055P, 2075P, VFAS3-4110PC to 4185PC**

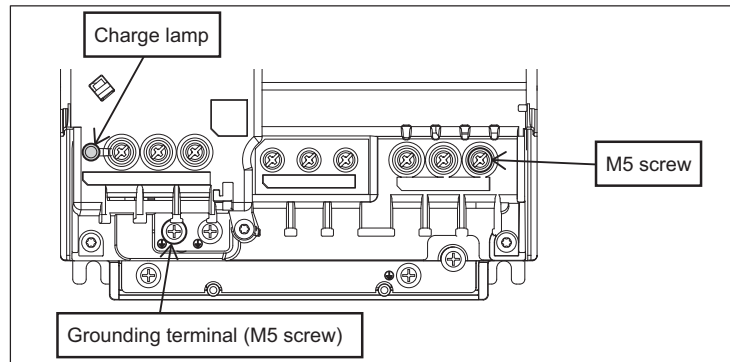
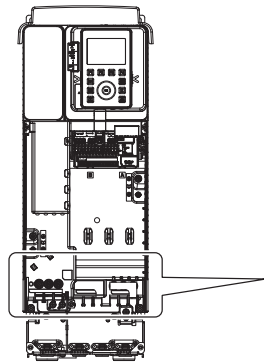

**2**

**4) Frame size A4**  
**VFAS3-2110P to 2185P, VFAS3-4220PC to 4370PC**

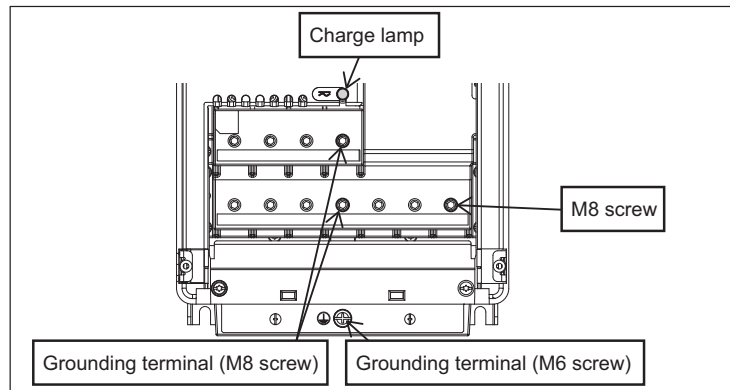
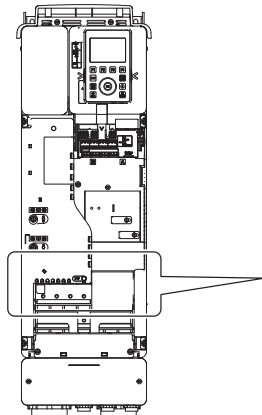

**5) Frame size A5**  
**VFAS3-2220P to 2370P, VFAS3-4450PC to 4750PC**

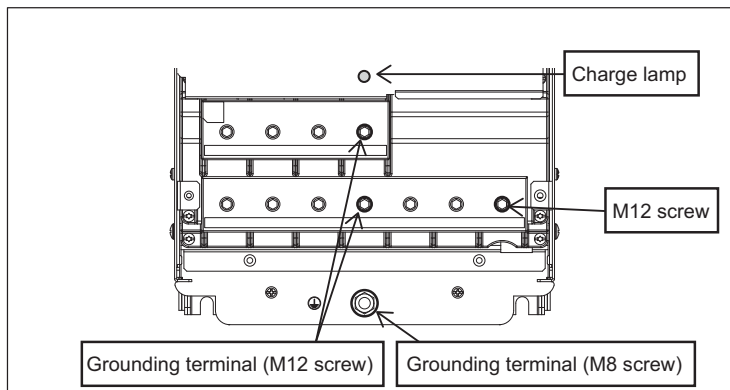
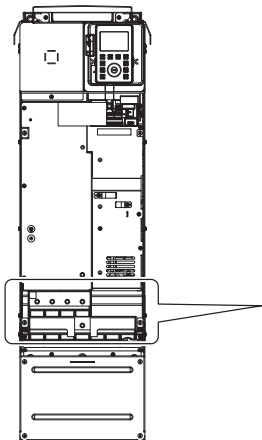

2

**6) Frame size A6  
VFAS3-2450P, 2550P, VFAS3-4900PC to 4132KPC**

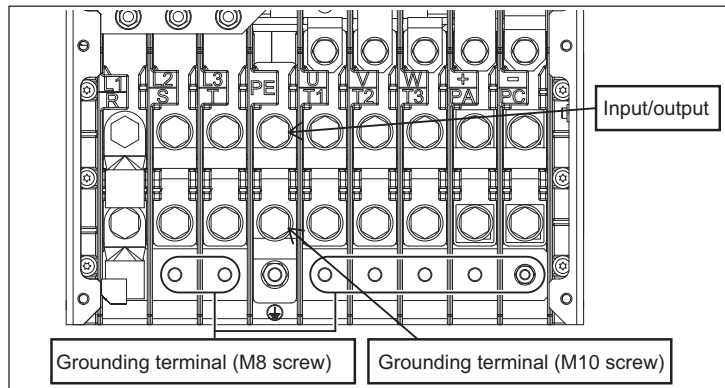
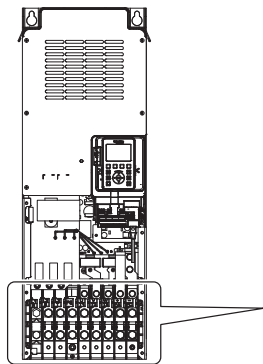

**7) Frame size A7  
VFAS3-4160KPC**

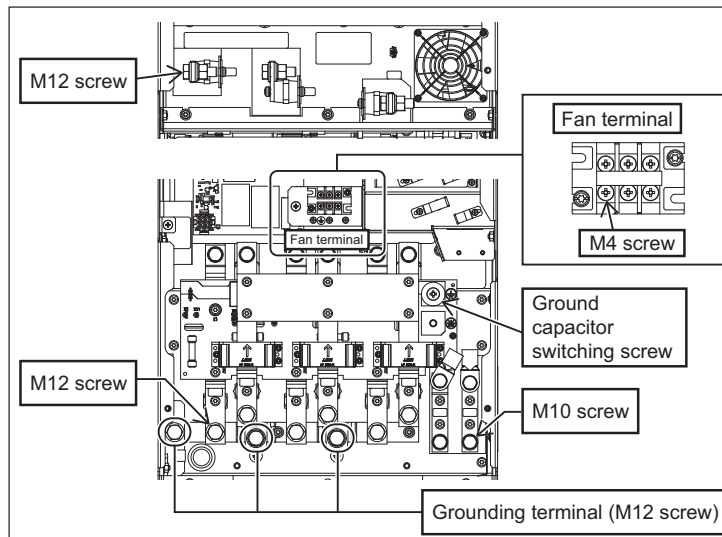
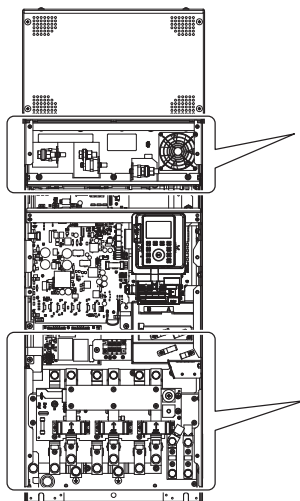

8) Frame size A8  
VFAS3-4200KPC to 4280KPC

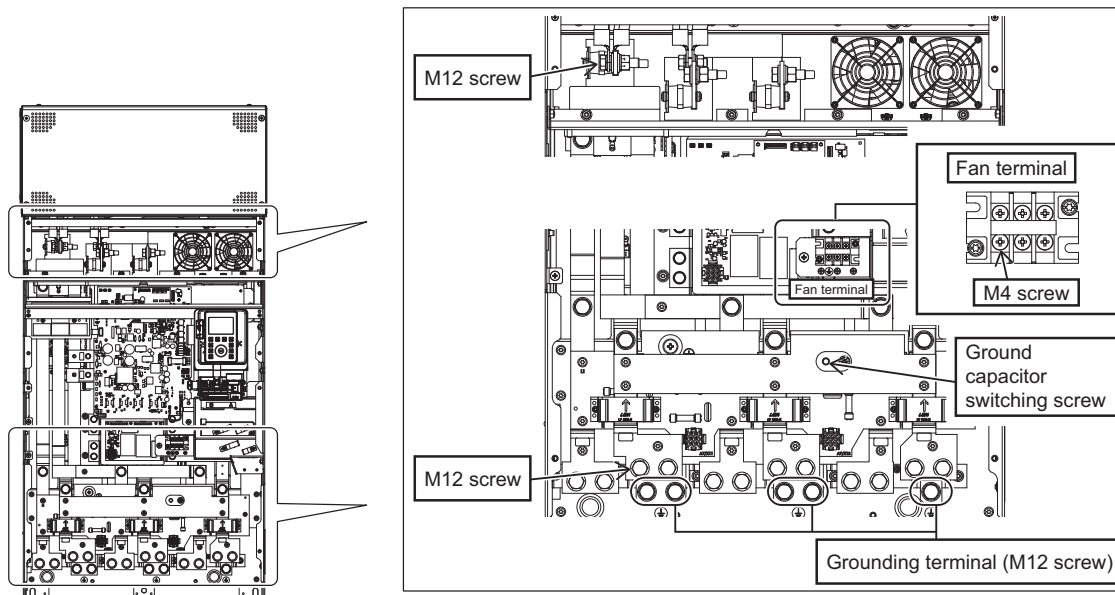

2

**2. 3. 4 Switching of grounding capacitor**

**⚠ WARNING**



Prohibited

- When using this 480V class inverter with a power supply system that is grounded in other than the neutral point (e.g. when the power supply has delta connection with single phase grounding), the grounding capacitor should not be grounded (or the capacity of the grounding capacitor should not be increased). Otherwise, it will result in failure or fire.

This inverter has a built-in noise filter (EMC noise filter for 480V class) and the inverter input power supply is grounded via the capacitor. By switching this grounding capacitor, the leakage current from the inverter can be reduced.

It is switched by changing the position of the exclusive switching screw(s) that varies depending on the type. For some types, the grounding capacitor is completely disconnected (frame size A1 to A5). For others, the capacitor capacity is reduced (frame size A6 to A8).

For the details of the influence of the leakage current and measures, refer to [2. 4. 3].



Important

- Note that when the grounding capacitor is reduced or not grounded, the inverter unit no longer comply with the EMC directive.
- Be sure to switch with the power off.
- For models with two switching screws, be sure to set both screws to the same side.

Switch the grounding capacitor in the following procedure given for each type. At the time of shipping, the grounding capacitor is grounded or its capacity is small.

**2**

■ **With frame size A1**  
**VFAS3-2004P to 2022P, VFAS3-4004PC to 4037PC**

- 1 Remove the front cover.  
 For how to remove, refer to [2. 2. 1].
- 2 Remove two screws for switching of grounding capacitor.  
 The grounding capacitor is disconnected.  
 Mount the removed screws to the positions shown in the figure on the right and tighten them.
- 3 To recover the shipping state, mount the two screws for switching of grounding capacitor and tighten them.  
 The grounding capacitor is connected and grounded.
- 4 After switching, mount the front cover.  
 For how to mount, refer to [2. 2. 1].

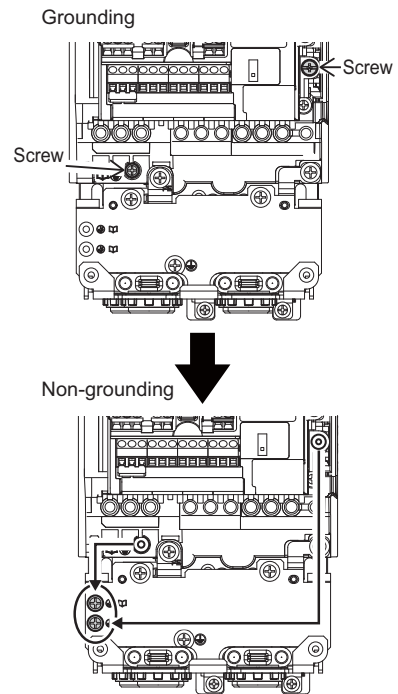

- For models with two switching screws, be sure to set both screws to the same side.



■ **With frame size A2**  
**VFAS3-2037P, VFAS3-4055PC, 4075PC**

- 1 Remove the front cover.  
 For how to remove, refer to [2. 2. 1].
  
- 2 Remove two screws for switching of grounding capacitor.  
 The grounding capacitor is disconnected.  
 Insert the removed screws to the positions shown in the figure on the right.
  
- 3 To recover the shipping state, mount the two screws for switching of grounding capacitor and tighten them.  
 The grounding capacitor is connected and grounded.
  
- 4 After switching, mount the front cover.  
 For how to mount, refer to [2. 2. 1].

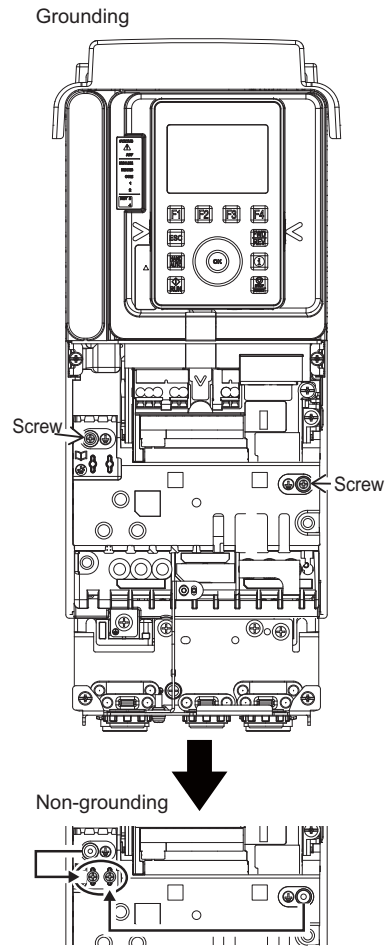

**2**



Important

- For models with two switching screws, be sure to set both screws to the same side.

**2**

■ **With frame size A3**  
**VFAS3-2055P, 2075P, VFAS3-4110PC to 4185PC**

- 1 Remove the front cover.  
 For how to remove, refer to [2. 2. 1].
- 2 Remove two screws for switching of grounding capacitor.  
 The grounding capacitor is disconnected.  
 Insert the removed screws to the positions shown in the figure on the right.
- 3 To recover the shipping state, mount the two screws for switching of grounding capacitor and tighten them.  
 The grounding capacitor is connected and grounded.
- 4 After switching, mount the front cover.  
 For how to mount, refer to [2. 2. 1].

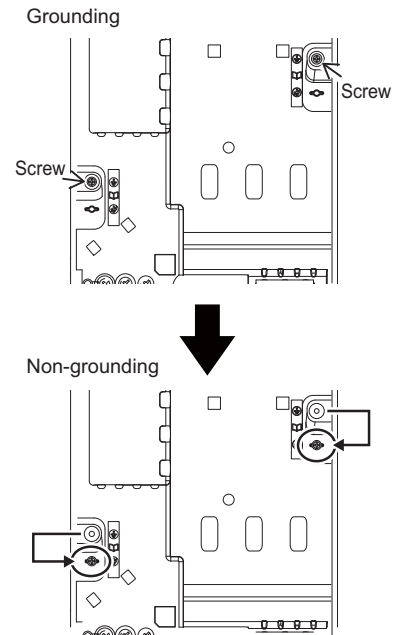

- For models with two switching screws, be sure to set both screws to the same side.

■ **With frame size A4**  
**VFAS3-2110P to 2185P, VFAS3-4220PC to 4370PC**

- 1 Remove the front cover.  
 For how to remove, refer to [2. 2. 2].
- 2 Remove the screw(s) for switching of grounding capacitor from the position of the grounding mark and insert it/them into the position of the non-grounding mark.  
 The 240 V class has one screw.  
 The 480 V class has two screws. Remove both of two screws.  
 The grounding capacitor is disconnected.
- 3 To recover the shipping state, remove the screw(s) for switching of grounding capacitor and tighten it/them to the screw hole in the position of the grounding mark.  
 The grounding capacitor is connected and grounded.
- 4 After switching, mount the front cover.  
 For how to mount, refer to [2. 2. 2].

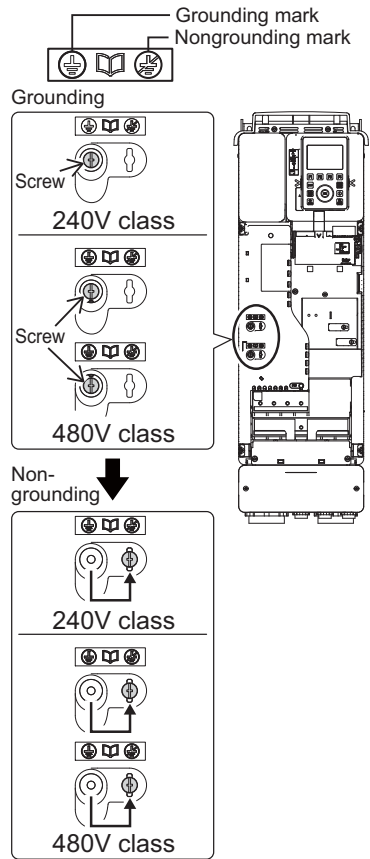

- For models with two switching screws, be sure to set both screws to the same side.

2

■ **With frame size A5**  
**VFAS3-2220P to 2370P, VFAS3-4450PC to 4750PC**

- 1 Remove the front cover.  
 For how to remove, refer to [2. 2. 3].
- 2 Remove the screw for switching of grounding capacitor from the position of the grounding mark and tighten it to the position of the non-grounding mark.  
 The grounding capacitor is disconnected.
- 3 To recover the shipping state, remove the screw(s) for switching of grounding capacitor and tighten it/them to the screw hole in the position of the grounding mark.  
 The grounding capacitor is connected and grounded.
- 4 After switching, mount the front cover.  
 For how to mount, refer to [2. 2. 3].  
 For frame size A6, A7 and A8, grounding capacitor is set to small (non-grounding mark side). To comply with EMC directive, switch the capacitance into large (grounding mark side) according to the procedure below.

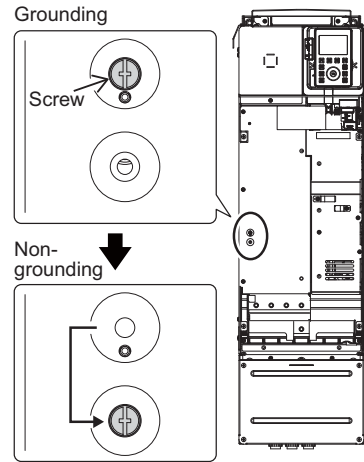

■ **With frame size A6**  
**VFAS3-2450P, 2550P, VFAS3-4900PC to 4132KPC**

Grounding capacitor is set to small (non-grounding mark side). To comply with EMC directive, switch the capacitance into large (grounding mark side) according to the procedure below.

- 1 Remove the front cover and the transparent cover inside (transparent resin).  
 For how to remove, refer to [2. 2. 4].
- 2 Remove the screw for switching of grounding capacitor from the position of the non-grounding mark and tighten it to the position of the grounding mark.  
 The grounding capacitor's capacity is increased.
- 3 To recover the shipping state, remove the screw(s) for switching of grounding capacitor and tighten it to the screw hole in the position of the non-grounding mark.  
 The grounding capacitor's capacity is recovered.
- 4 After switching, mount the transparent cover and the front cover in this order.  
 For how to mount, refer to [2. 2. 4].

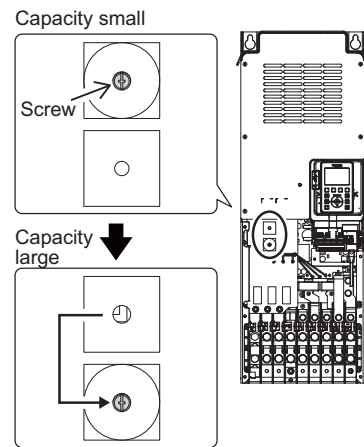

■ With frame size A7  
VFAS3-4160KPC

- 1 Remove the front cover and the transparent cover inside (transparent resin).  
For how to remove, refer to [2. 2. 5].
- 2 Remove the screw for switching of grounding capacitor from the position of the grounding mark and tighten it to the position of the non-grounding mark.  
The grounding capacitor's capacity is increased.
- 3 To recover the shipping state, remove the screw(s) for switching of grounding capacitor and tighten it/them to the screw hole in the position of the non-grounding mark.  
The grounding capacitor's capacity is reduced.
- 4 After switching, mount the transparent cover and the front cover in this order.  
For how to mount, refer to [2. 2. 5].

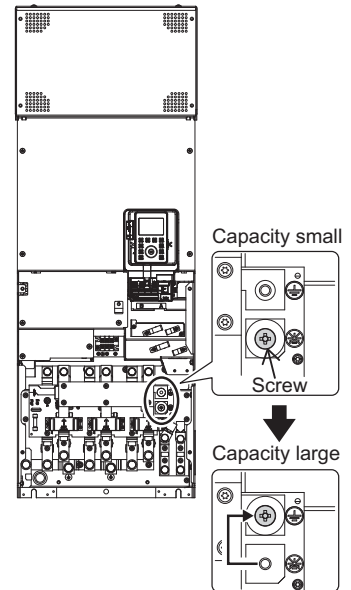

2

 CAUTION



- In case of one phase grounding system (A three-phase supply power is connected in delta), do not change the connection of grounding capacitor before factory setting. If connection changed (this means the capacitance is increased), the capacitor may become damaged.

Note) If a neutral grounding system is used, changing the connection of the grounding capacitor as shown in the figure at the top (changing the capacitance from Small to Large) makes the inverter compliant with the EMC directive.

2

■ With frame size A8  
VFAS3-4200KPC to 4280KPC

- 1 Remove the front cover and the transparent cover inside (transparent resin).  
For how to remove, refer to [2. 2. 5].
- 2 Remove the screw for switching of grounding capacitor from the position of the grounding mark and tighten it to the position of the grounding mark.  
The grounding capacitor's capacity is increased.
- 3 To recover the shipping state, remove the screw(s) for switching of grounding capacitor and tighten it/them to the screw hole in the position of the non-grounding mark.  
The grounding capacitor's capacity is reduced.
- 4 After switching, mount the transparent cover and the front cover in this order.  
For how to mount, refer to [2. 2. 5].

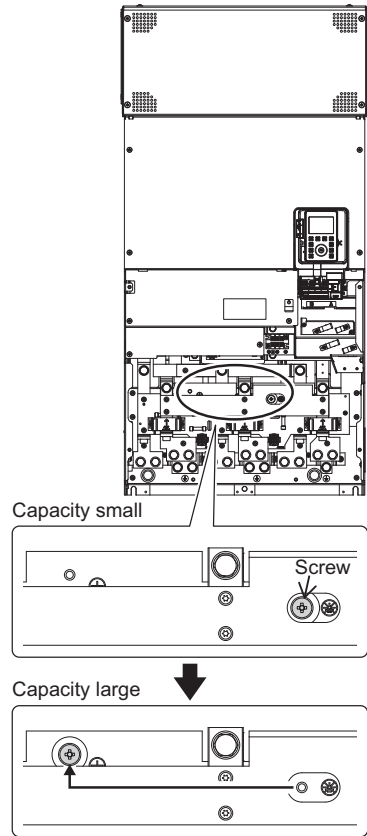

 CAUTION



- In case of one phase grounding system (A three-phase supply power is connected in delta), do not change the connection of grounding capacitor before factory setting. If connection changed (this means the capacitance is increased), the capacitor may become damaged.

Note) If a neutral grounding system is used, changing the connection of the grounding capacitor as shown in the figure at the top (changing the capacitance from Small to Large) makes the inverter compliant with the EMC directive.

### 2. 3. 5    Control terminals

The control terminals are connected to external control equipment to control operation of the inverter and motor and monitor the state externally.

■ **Functions of control terminals**

The control terminal block is common to all the models.



2

2

Terminal symbol	Input/output	Function	Electrical specifications	Internal circuit
F	Input	Multifunction programmable digital input. In the default setting, forward run is performed with ON and deceleration stop with OFF.	Digital input. • 24 Vdc-5 mA or less  Compliant with IEC61131-2 logic type 1 • Sink logic: ON < 10 V, 16 V < OFF • Source logic: OFF < 5 V, 11 V < ON  Sink logic and source logic can be switched with the slide switch [SW1]	
R	Input	Multifunction programmable digital input. In the default setting, reverse run is performed with ON and deceleration stop with OFF.		
RES	Input	Multifunction programmable digital input. In the default setting, this inverter protective function is reset by ON→OFF. It has no effect when the inverter is in a normal condition.		
S1	Input	Multifunction programmable digital input. In the default setting, preset speed operation is performed with ON		
S2	Input	Multifunction programmable digital input. In the default setting, preset speed operation is performed with ON		
S3	Input	Multifunction programmable digital input. In the default setting, preset speed operation is performed with ON		
S4	Input	Multifunction programmable digital input. In the default setting, preset speed operation is performed with ON With <F146: Terminal S4 input select>, digital input, pulse train input, and PG input can be switched.	Digital input. • 24 Vdc-5 mA or less  Compliant with IEC61131-2 logic type 1 • Sink logic: ON < 10 V, 16 V < OFF • Source logic: OFF < 5 V, 11 V < ON  Sink logic and source logic can be switched with the slide switch [SW1]  Pulse train input • Up to 30 kpps (duty 50%)	
S5	Input	Multifunction programmable digital input. In the default setting, preset speed operation is performed with ON. With <F147: Terminal S5 input select>, digital input, pulse train input, and PG input can be switched.		

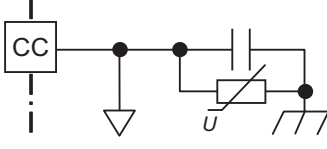
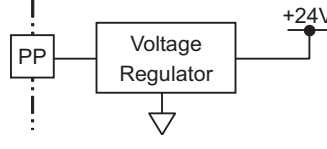
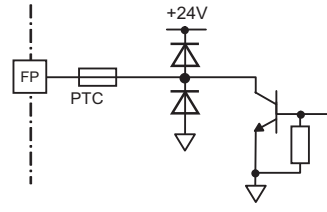
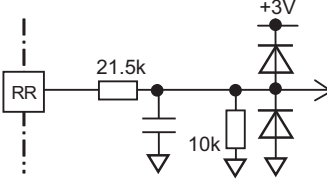
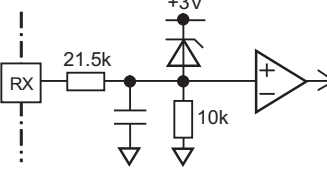
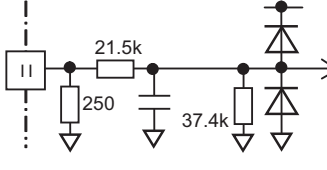

Terminal symbol	Input/output	Function	Electrical specifications	Internal circuit
CC	Common to input/output	An equipotential terminal of the control circuit. It is allocated in three positions.	-	
PP	Output	Voltage reference output for potentiometer.	10 Vdc (allowable load current: 10 mA <sub>dc</sub> )	
FP	Output	Multifunction programmable digital/pulse train output. With <F669: Terminal FP switching>, digital output and pulse train output can be switched.	Digital output • 24 Vdc-50 mA  Pulse train output • Up to 30 kpps (duty 50%)	
RR	Input	Analog input with 0 - 10 Vdc. It can be switched to PTC input, etc. with <F108: Terminal RR input select>.	0 - 10 Vdc (Input impedance: 31.5 kΩ)	
RX	Input	Analog input with -10 to +10 Vdc. With <F107: Terminal RX input voltage select>, it can be switched to 0 - 10 Vdc.	-10 to +10 Vdc (Input impedance: 31.5 kΩ)	
II	Input	Analog current input with 0 - 20 mA <sub>dc</sub> . The current can be changed to 4 - 20 mA, etc. with setting of the parameter.	0 - 20 mA <sub>dc</sub> (Input impedance: 250 Ω)	

2

Terminal symbol	Input/output	Function	Electrical specifications	Internal circuit
FM	Output	Multifunction programmable analog output. 0 - 10 Vdc output with default setting. With <F681: Terminal FM switching>, meter option (0 - 1 mA), current (0 - 20 mA) output, and voltage (0 - 10 V) output can be switched.	0 - 10 Vdc (allowable load resistance: 1 kΩ or more) 4 - 20 mAdc (0 - 20 mAdc) (allowable load resistance: 500 Ω or less)	
AM	Output	Multifunction programmable analog output. 0 - 20 mAdc output with default setting. With <F686: Terminal AM switching>, meter option (0 - 1 mA), current (0 - 20 mA) output, and voltage (0 - 10 V) output can be switched.		
PLC	Output	When the slide switch [SW1] is set to the sink side or source side, it can be used as 24 Vdc power output.	24 Vdc-200 mA (200 mA in total with P24) Compliant with IEC61131-2	
	Input	When the slide switch [SW1] is set to the PLC side, it can be used as a common terminal for digital input terminal.	-	
P24	Output	24 Vdc power output.	24 Vdc-200 mA (200 mA in total with PLC) Compliant with IEC61131-2	
+SU	Input	DC power input to operate the control circuit. Connect a control power supply option or 24 Vdc power supply between [+SU] and [CC].	24 Vdc- current 1A or more	
STOA	Input	STO function that complies with the safety standard IEC61800-5-2 (this is different function from programmable digital input). Function is deactivated by shorting the terminals [STOA]-[STOB]-[PLC] with a bridge at factory.	Compliant with IEC61131-2 logic type 1 • Activate < 5 V, 11 V < Deactivate  Refer to Safety Function Manual.	
STOB	Input	When STOA/STOB are OFF during motor is running, motor becomes coast stop. Under this condition, even if STOA/STOB are ON, motor is not running unless run command is once OFF and On again. For details, refer to Safety function manual (E6582067).		

Terminal symbol	Input/output	Function	Electrical specifications	Internal circuit
FLA	Output	Multifunction programmable relay contact output. Operation of the protection function of the inverter is detected in the default setting. The contact across [FLA]-[FLC] is closed and [FLB]-[FLC] is opened during protection function operation.	Maximum contact capacity <ul style="list-style-type: none"> <li>• 250 Vac-2 A (<math>\cos\phi=1</math>)</li> <li>• 30 Vdc-2 A (at resistive load)</li> <li>• 250 Vac-1 A (<math>\cos\phi=0.4</math>)</li> <li>• 30 Vdc-1A (L/R=7 ms)</li> </ul>	
FLB				
FLC				
R1A	Output	Multifunction programmable relay contact output. A low-speed signal is output in the default setting.	Minimum contact capacity <ul style="list-style-type: none"> <li>• 24 Vdc-5 mA</li> </ul>	
R1C				
R2A	Output	Multifunction programmable relay contact output. It is not assigned in the default setting. The function can be set with <F134: Terminal R2 function >.	Life <ul style="list-style-type: none"> <li>• 100000 times</li> </ul>	
R2C				

2



Important

- With relay contact output, chattering (momentary ON/OFF of contact) is generated by external factors of the vibration and the impact, etc. In particular, please set a filter of 10 ms or more, or timer for measures when connecting it directly to the input unit of the programmable controller.

Reference

- To change the function of the terminals [F], [R], [RES], and [S1] - [S5] → Refer to [6. 3. 2]
- To change the function of the terminals [FP], [FL], [R1], and [R2] → Refer to [6. 3. 3]
- To change the function of the terminals [RR] and [RX] → Refer to [6. 2]
- To change the function of the terminals [FM] and [AM] → Refer to [5. 2. 6], [6. 33. 3]

■ Recommended tightening torque of control terminal screws

Control terminal torque and wire strip length

	Screw size	Torque		Strip length (mm)	Screwdriver size	
		(N · m)	(lb · in)		Width (mm)	Thickness
Relay	M3	0.5	4.4	11	3.5	0.5
Except Relay (2nd)	M3	0.5	4.4	6 or 7	3.5	0.5
Except Relay (1st)	M3	0.5	4.4	6	3.5	0.5

**Wire size**

	Conductor	Using one wire		Using two wires		Using two wires with twin ferule	
		(mm <sup>2</sup> )	AWG	(mm <sup>2</sup> )	AWG	(mm <sup>2</sup> )	AWG
Relay	Solid wire	0.14-2.5	26-14	2x0.14 to 2x0.75	26-18	-	-
	Stranded wire	0.14-2.5	26-14	2x0.14 to 2x0.75	26-18	2x0.5 to 2x1.5	20-16
Except Relay (2nd)	Solid wire	0.14-2.5	26-14	2x0.14 to 2x1.0	26-18	-	-
	Stranded wire	0.14-1.5	26-16	2x0.14 to 2x0.75	26-18	2x0.5 to 2x1.0	20-18
Except Relay (1st)	Solid wire	0.14-1.5	26-16	2x0.14 to 2x0.75	26-18	-	-
	Stranded wire	0.14-1.5	26-16	2x0.14 to 2x0.75	26-18	2x0.5 to 2x1.0	20-18

■ **Switching of slide switch of control terminal block**

With the slide switch [SW1] of the control terminal block, the setting of sink logic, source logic and external power supply sink logic of the digital input terminals [F], [R], [RES], and [S1] - [S5] is switched.

For details of sink/source logic, refer to the following "■Sink logic and source logic."

- The slide switch [SW1] is set to the PLC side in the default setting. This is the setting when the inverter external power supply is used
- To use as sink logic, set the slide switch [SW1] to the SINK side.
- To use as source logic, set the slide switch [SW1] to the SOURCE side.



Important

- Switch the logic before turning on the power supply.
- After confirming that the sink/source setting is correct, turn on the power supply.

■ **Sink logic and source logic**

In Japan and the U.S., current flowing out turns digital input terminals on. This is called sink logic. The method generally used in Europe is source logic in which current flowing into digital input terminals turns them on.

Each digital input terminal is supplied with electricity from either the inverter's internal power supply or an external power supply, and its connections vary depending on the power supply used.

**Memo**

- Sink logic is sometimes referred to as negative logic, and source logic is referred to as positive logic.

1) **When the inverter internal power supply is used**

When the internal power supply of the inverter is used to supply electricity to digital input terminals, the connection is as shown in the diagram below.

Sink/source logic is set by the slide switch [SW1]. Refer to "■Switching of slide switch of control terminal block."

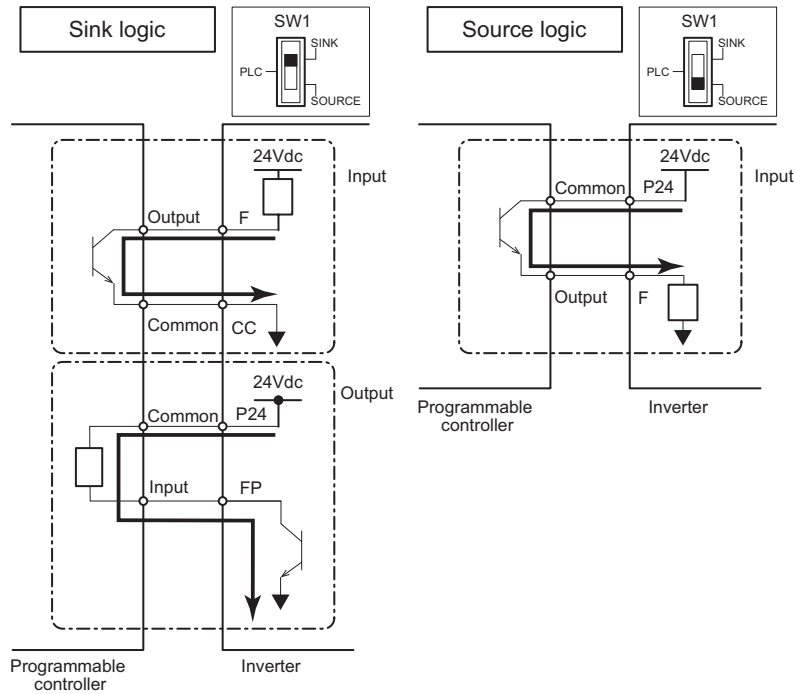

2

**2) When an external power supply is used**

The terminal [PLC] is used to connect to an external power supply or to separate a terminal from other input or output terminals.

Sink/source logic is set by the slide switch [SW1].

Refer to "■Switching of slide switch of control terminal block."

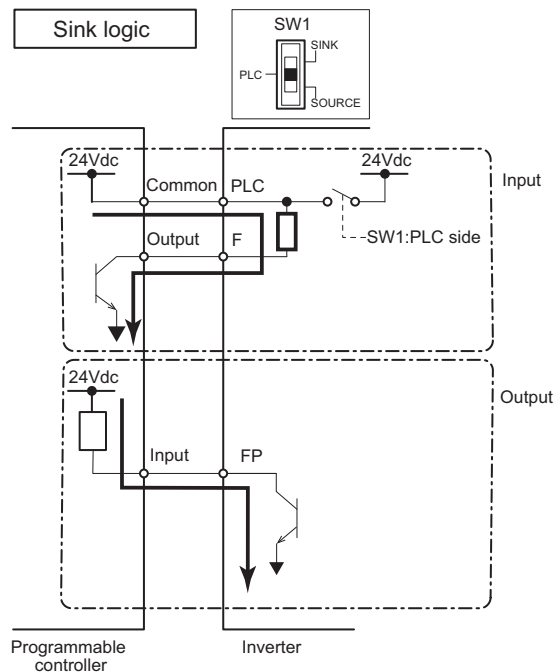

### **2. 3. 6 RS485 communication connectors**

This inverter is equipped with two RS485 communication ports.

To use RS485, refer to "RS485 Communication Function Instruction Manual" (E6582143).



Important

- Connection of Ethernet to the RS485 communication connectors will result in a failure.

## **2**

### **2. 3. 7 Ethernet connectors**

This inverter is equipped with two Ethernet ports.

To use Ethernet, refer to "Ethernet Function Instruction Manual" (E6582125).



Important

- Connection of RS485 communication connectors to Ethernet may result in a malfunction.

## 2. 3. 8 Mounting of DC reactor

### ⚠ Caution



Mandatory  
action

- Mount the attached DC reactor (DCL) for VFAS3-4160KPC ~ 4280KPC.  
If you do not mount the attached DC reactor (DCL), it will result in malfunction. Mount the DC reactor (DCL) between [PA/+] and [PO].

This inverter is equipped with a DC reactor (DCL) as standard, however, for VFAS3-4160KPC to 4280KPC, it is packaged together with the unit.

After installing the inverter, mount the DC reactor in the following procedure.

#### ■ With frame size A7 VFAS3-4160KPC

- 1 Remove the front cover (upper) of the inverter unit in advance.  
For how to remove, refer to [2. 2. 5].

- 2 Remove four screws of the DC reactor cover of the DC reactor.  
Store the removed screws so as not to be lost.

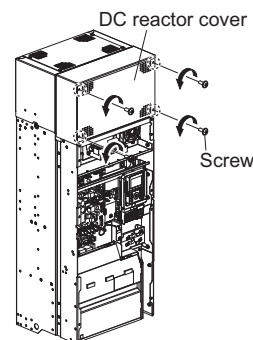

- 3 Remove the DC reactor cover from the DC reactor by pulling it down.  
The upper side of the DC reactor cover is to be inserted.

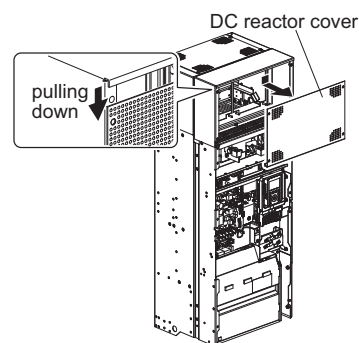

2

**2**

- 4 Remove four screws of the top cover (mesh) of the DC reactor.  
Store the removed screws so as not to be lost.

- 5 Remove the top cover (mesh) from the DC reactor.

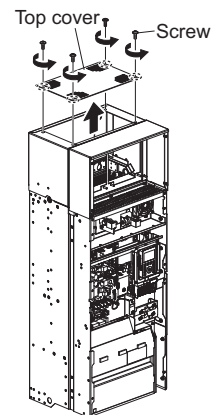

- 6 Check the positions of four mounting holes on the back side of the DC reactor and mount the DC reactor to the panel.

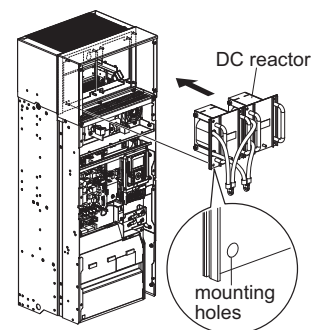

- 7 Wire the DC reactor and the terminals [PA/+] and [PO] of the power terminal block.  
Connect two wires (with a crimp-style terminal) from each of two DC reactor units to [PA/+] and [PO].  
Connect two flat braided wires for grounding to the grounding terminals respectively.

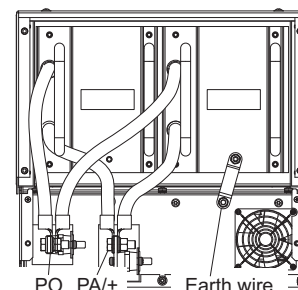

- 8 Mount the top cover (mesh) to the DC reactor and tighten four screws.

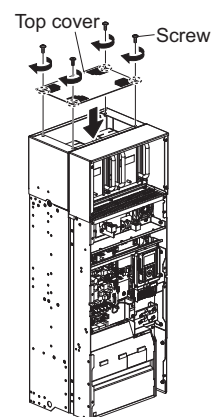



- 9 Mount the DC reactor cover to the DC reactor and tighten four screws according to necessity of other work.  
After mounting the DC reactor to the inverter, mount the front cover (upper) before the DC reactor cover.

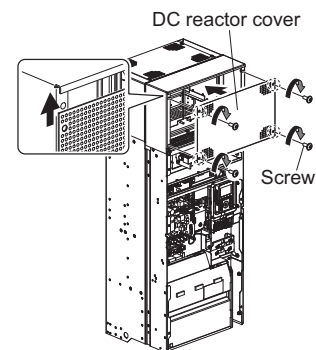

2

**Memo**

- After mounting the DC reactor to the inverter, if the DC reactor cover is mounted and fixed, the front cover (upper) cannot be mounted. Be sure to mount the front cover (upper) before the DC reactor cover.

■ **With frame size A8**  
**VFAS3-4200KPC to 4280KPC**

Except for its wider unit, frame size A8 has the same enclosure and structure as frame size A7.  
The mounting procedure of the DC reactor is the same as that of frame size A7, however, more wires are connected to the inverter unit.  
An example of wiring is shown below.

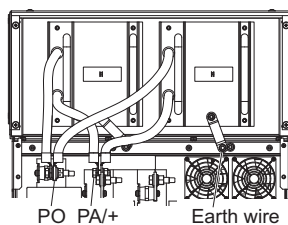

## 2.4 Cautions for application

This section introduces cautions for use of the motor and inverter, influence of leakage current on peripheral devices, and measures against it.

### 2.4.1 Motor

#### CAUTION



Mandatory  
action

- Use the inverter that conforms to specifications of the power supply and the three-phase motor to be operated.  
If you use the inappropriate inverter, not only will the three-phase motor not rotate correctly, but it will cause serious accidents such as overheating and burning out.

When this inverter and the motor are used in conjunction, pay attention to the following items.

#### ■ Comparison with commercial power supply operation

This inverter employs the sinusoidal PWM control. However, the output voltage and output current are not perfect sine waves. They have a distorted wave that is close to sinusoidal waveform. This is why there will be a slight increase in motor temperature, noise and vibration, compared to operation with a commercial power supply.

#### ■ Operation in low-speed range

When running continuously at low speed in conjunction with a general purpose motor, there may be a decline in that motor's cooling effect. If this happens, operate with the output lower than the ratedload.

To carry out low-speed operation continuously at the rated torque, use a constant torque motor. In this case, select "constant torque motor" of "4" -"7" in <OLM: Motor overload protection characteristic>. For details, refer to [5. 2. 5].

#### ■ Adjusting motor overload protection level

This inverter has a built-in electronic thermal for motor overload protection. The electronic thermal's reference current is set to the inverter's rated current in default setting, so adjust it in line with the rated current of the motor being used in combination before operation.

For how to set, refer to [5. 2. 5].

#### ■ High speed operation over 60 Hz

Operating at frequencies over 60 Hz will increase noise and vibration. This may exceed the motor's mechanical strength limits and the bearing limits so you should inquire to the motor's manufacturer about such operation.

#### ■ Lubricating mechanisms

Operating an oil-lubricated reduction gear and gear motor in the low-speed range will worsen the lubricating effect. Check with the manufacturer of the reduction gear to find out about operable gearing area.

■ **Occurrence of instability (abnormal vibrations and overcurrent trips)**

Unstable phenomena such as abnormal vibrations and overcurrent trips may occur depending on combinations of the inverter and motor, and load.

- 1) In the following cases, lower the settings of inverter carrier frequency.
  - Combined with a motor that is extremely below applicable motor ratings for the inverter
  - Combined with light load with a load factor of 5% or less
  - Combined with load whose inertial moment is very small
  - Combined with special motors

For details, refer to [6. 14].

- 2) In the following case, set the S-pattern acceleration/deceleration function (refer to [6. 27. 1]). When vector control is selected, adjust the load moment of inertia ratio (refer to [6. 23. 1] or switch to V/f constant mode (refer to [5. 3. 4]).

- Combined with couplings between load devices and motors with high backlash

- 3) When vector control is selected, adjust the load moment of inertia ratio (refer to [6. 23. 1] or switch to V/f constant control (refer to [5. 3. 4]) in the following case.

- Combined with loads that have sharp fluctuations in rotation such as piston movements

■ **Braking motor when turning off power supply**

A motor with its power turn off goes into coasting state, and does not stop immediately.

To stop the motor quickly as soon as the power is turn off, install an auxiliary brake. There are different kinds of brake devices, both electrical and mechanical. Select the brake that is best for the system.

■ **Load that produces regenerative torque**

When combined with a load that produces regenerative torque, the overvoltage or overcurrent protection function may be activated to trip the inverter. Install a braking resistor to deal with it. For details of the braking resistor, refer to [10. 3. 2].

■ **Motors with brake**

When motors with a brake are directly connected to the inverter's output, the brake cannot be released at startup because of low voltage. Wire the brake circuit separately from the power circuit.

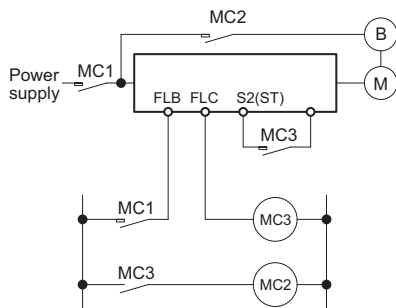

Circuit diagram 1

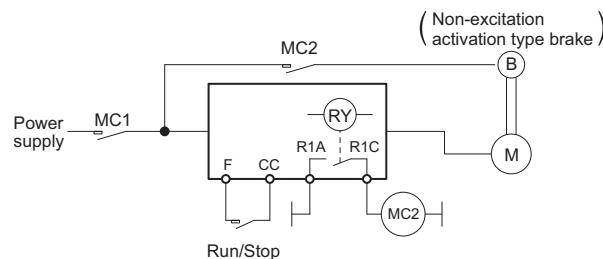

Circuit diagram 2

Circuit diagram 1 is an example in which the standby function is assigned to the terminal [S2]. This circuit can be applied to a machine that mainly operates horizontally. Set the terminal [S2] to "Open" to turn off output of the inverter and have the motor in coasting state. Then, operate the brake. If the brake is operated with inverter output, the inverter may trip due to bound current. Note that when it is applied to a machine with vertical movements, the motor may fall when it is in coasting state.

Circuit diagram 2 is an example in which low-speed signals are assigned to the terminals [R1A]-[R1C]. This circuit can be applied also to a machine with vertical movements. At the time of start, output is made from the inverter while the brake is operating. When the output frequency reaches <F100: Low-speed signal output frequency>, the brake is released by the signal output from the terminals [R1A]-[R1C]. When the machine stops, the inverter comes to deceleration stop. When the output frequency decreases under <F100>, the output signal from the terminals [R1A]-[R1C] becomes off and the brake operates.

### ■ Measures to protect motors against surge voltages

In a system in which a 480 V class inverter is used to control the operation of a motor, very high surge voltages may be produced depending on the wire length, wire routing and types of wires used. If such surge voltages are applied repeatedly for a long time, it may cause deterioration of insulation of motor coils.

Here are some examples of measures against surge voltages.

- Decrease <F300: Carrier frequency> of the inverter.
- Use a motor with high insulation strength.
- Insert an AC reactor or a motor-end surge voltage suppression filter between the inverter and the motor. Refer to [10. 3. 5].

## 2. 4. 2 Inverters

For the inverters to be used, pay attention to the following items.

### ■ Inverter capacity

Do not operate a motor whose capacity is larger than the inverter (e.g. a 45 kW motor with a 30 kW inverter), no matter how light the load is. Current ripple will raise the output peak current, making it easier to set off the overcurrent trip.

### ■ Power factor correction capacitor

Power factor correction capacitors cannot be installed on the output side of the inverter. To operate a motor with a power factor correction capacitor attached, remove the capacitor. Otherwise, it will cause an inverter malfunction and capacitor destruction.

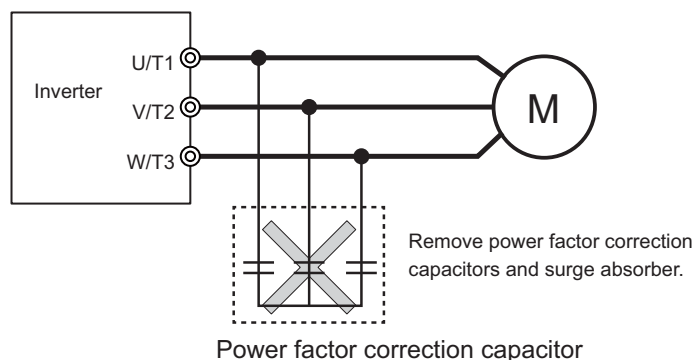

■ **Operating at other than rated voltage**

Connections to voltages other than the rated voltage described in the rating label cannot be made. If a connection must be made to a power supply other than one with rated voltage, use a transformer to raise or lower the voltage to the rated voltage.

■ **Selective circuit breaking when two or more inverters are used on the same power line**

There is no fuse in the inverter's power circuit. Thus, as the diagram below shows, when more than one inverter is used on the same power line, you must select interrupting characteristics so that only ELCB (ELCB1 to ELCBn in the diagram) install in each inverter will trip and the common MCCB (MCCB in the diagram) will not trip when a short occurs in one inverter.

When you cannot select the proper characteristics, install a circuit interrupting fuse on the secondary side of ELCB1 to ELCBn.

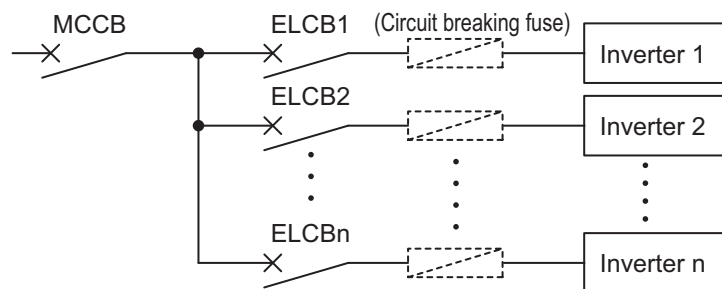

Selective circuit breaking of inverters

- \* MCCB : Molded Case Circuit Breaker
- \* ELCB : Earth Leakage Circuit Breaker

■ **If power supply distortion is not negligible**

If the power supply distortion is not negligible because the inverter shares a power distribution line with other systems causing distorted waves, such as systems with thyristors or large-capacity inverters, install an input reactor to improve the input power factor, to reduce higher harmonics, or to suppress external surges.

For details, refer to [10. 3. 1].

■ **Disposal**

To dispose the inverter, refer to [Chapter 16].

### 2. 4. 3 What to do about leakage current

#### ⚠ CAUTION



Mandatory  
action

- Take countermeasures against leakage current.  
The leakage current through the stray capacitance of the input/output power wires of inverter and motor can affect peripheral devices. In that case, please take countermeasures such as reducing the carrier frequency or shortening the length of input/output power wires. When the total wire length (total length between an inverter and motors) is more than 100m, if the trip occurs with the motor no-load current, make enough space between phase wires or insert the filter (MSF: motor-end surge voltage suppression filter).
- Pay attention to the cable length  
In case the total cable length (total of length between an inverter and motors) is 100 m or more, a trip can occur even with no-load current. Make enough space among each phase cable or install the filter (MSF) as countermeasure.

Measures should be taken for leakage current across ground and leakage current between wires because they may cause a malfunction of peripheral device.

#### ■ Influence of leakage current across ground

Leakage current may flow not just through the inverter system but also through grounding wires to other systems. This leakage current will cause earth leakage circuit breakers (ELCB), leakage current relays, ground relays, fire alarms and sensors to operate improperly, and it will cause superimposed noise on the TV screen or display of incorrect current detection with the CT.

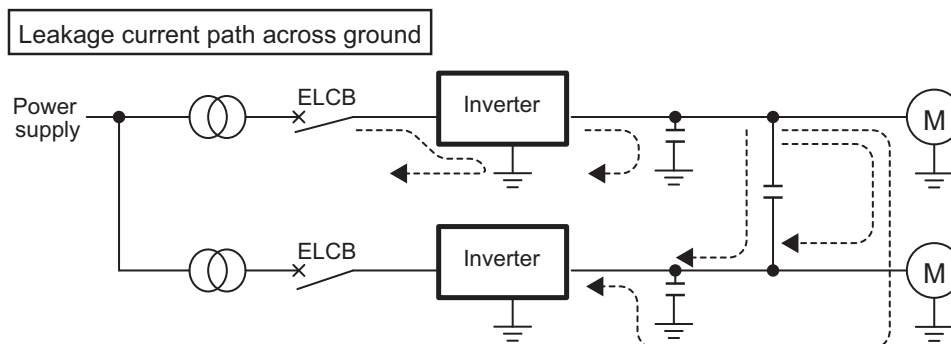

Here are some examples of measures against leakage current across ground.

- When there is no radio-noise interference or similar problem, switch the grounding capacitor of the EMC noise filter to "disconnected" (size A1 to A5) or "small capacitance" (size A6 to A8).  
For how to switch the grounding capacitor, refer to [2. 3. 4].
- Decrease <F300: Carrier frequency>.  
When there is no concern against the magnetic noise from the motor, carrier frequency reduction is effective measure. For details, refer to [6. 14].
- Use high frequency remedial products for ELCBs.
- Zero-phase reactor  
It may be effective over the motor cable.

#### Built-in noise filter

The 480 V models of this inverter has a built-in EMC noise filter, so the leakage current value in the delta connection (single-phase grounding) power supply may become greater. For detail, refer to application manual "leakage current" (E6581181).

■ Influence of leakage current across lines (in case of thermal relays)

The high frequency component of current leaking into electrostatic capacity between inverter output wires will increase the effective current values and make externally connected thermal relays operate unnecessarily. When the wires are long (50 m or more) or in case of models with motors of low rated current (several A (ampere) or less), especially the 480 V class low capacity (4.0 kW or less, 5.5 kW or less with ND) models, it will be easy for the external thermal relay to activate unnecessarily, because the ratio of leakage current against the motor rating will increase.

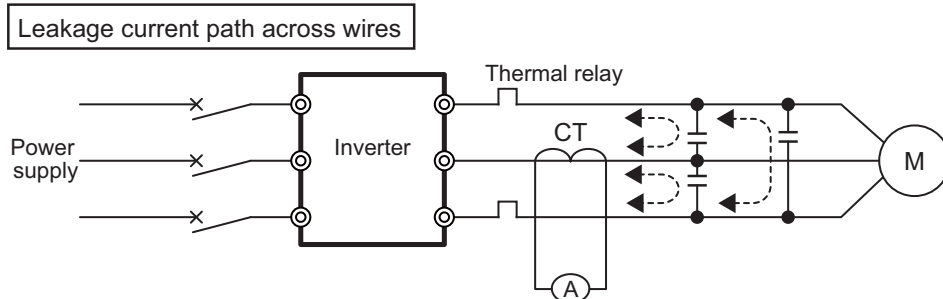

2

Here are some examples of measures against leakage current across lines.

- Use the electronic thermal of the inverter.  
The setting of the electronic thermal is done with <tHrA: Motor overload protection current 1>. For details, refer to [5. 2. 5].
- Decrease <F300: Carrier frequency>.  
However, note that the motor magnetic noise is increased.  
For details, refer to [6. 14].
- Install 0.1 to 0.5μF - 1000 V film capacitor to the input/output terminals of each phase in the thermal relay.

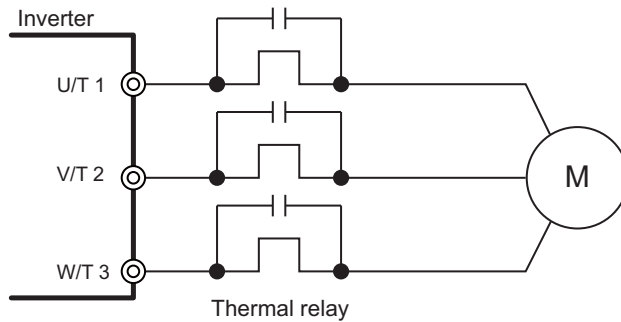

### ■ Influence of leakage current across lines (in case of CT and ammeter)

If a CT and ammeter are connected externally to detect inverter output current, the leak current's high frequency component may destroy the ammeter. If the wires are long (50 m or more) or in case of models with motors of low rated current (several A (ampere) or less), especially the 480 V class low capacity (4.0 kW or less, 5.5 kW or less with ND) models, it will be easy for the high frequency component to pass through the externally connected CT and be superimposed on and burn the ammeter, because the ratio of leakage current against the motor's rated current will increase.

Here are some examples of measures against leakage current across lines.

- Connect the ammeter to the terminal [FM] and terminal [AM] of the inverter.  
For how to connect the meter and how to set parameters, refer to [5. 3. 6].
- Check the current value with the monitor function.  
For details, refer to [8. 1. 1].
- Set <F300: Carrier frequency> to 5 kHz or less.  
However, this may increase noise on the motor side.  
For details, refer to [6. 14].



# 3

## [Basic operation]

# Operation panel and screen display

I

II

This chapter introduces the functions of the operation keys on the operation panel and screen display and explains how to operate them.

### Memo

- The specifications and operation procedure of the operation panel are common to all the types of this inverter.

## 3.1 Basic of operation panel

The operation panel allows you to set parameters and monitor the status. This section explains how to operate the operation panel and how to switch four types of display modes.

### 3.1.1 LCD screen and operation keys

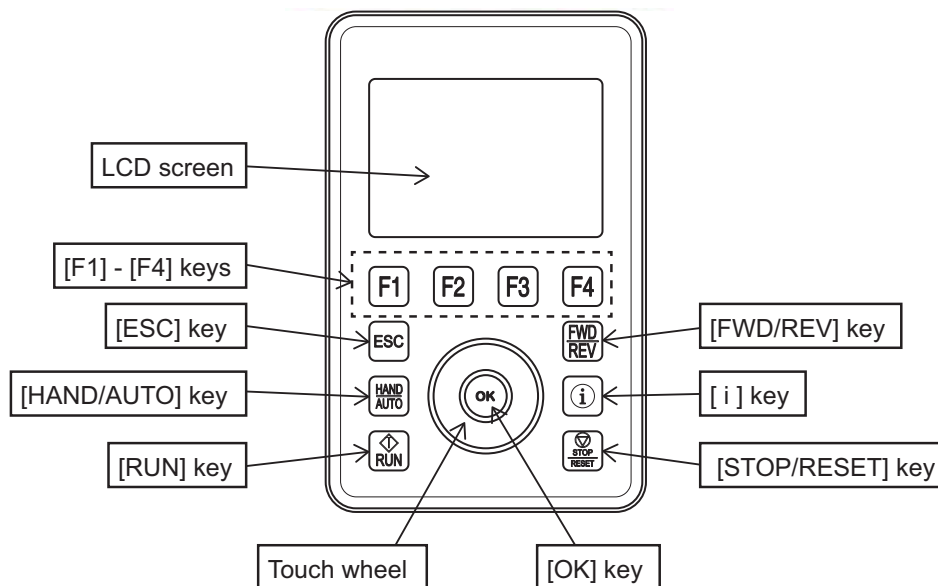

#### • LCD screen

This screen displays [Standard mode], [Setting mode], [Monitor mode], and [Easy mode] according to the purpose. When an error occurs, an alarm, trip, etc. are displayed. For details, refer to [3. 1. 2].

Normally, the backlight color is white, but it turns red when a trip occurs. You can adjust the contrast and set screen settings such as automatic off time. For details, refer to [3. 1. 3].

#### • [F1] - [F4] keys

They are keys to execute functions displayed on the screen.

For details, refer to [■[F1] - [F4] keys] described later in this subsection.

1

2

3

4

5

6

7

8

9

10

11

12

13

14

15

16

3

• **[ESC] key**

This key switches the display mode.

It is also used to return to the previous item of the hierarchy of the screen.

• **[HAND/AUTO] key**

This key switches between hand (operation panel)/remote (remote control).

It is used to operate the inverter temporarily at hand (operation panel) while performing terminal operation (remote control) normally.

To enable this key, set the parameter <F750: EASY key function>.

For details, refer to [6. 37].

• **[RUN] key**

This key is used for a run command from the operation panel.

To enable this key, set "1" to the parameter <CMOd: Run command select>.

For details, refer to [5. 2. 1].

• **[FWD/REV] key**

This key switches between forward run and reverse run of the motor during panel run.

It is enabled when the parameter <CMOd: Run command select> is "1" and <Fr: Panel Fwd/Rev run select> is "2" or "3".

For details, refer to [5. 3. 9].

• **[i] key**

This key displays information.

When "Website (QR code)" is selected, the information is QR code. When "Model information" is selected, model information is displayed.



Necessary information is displayed when a trip occurs.

And you can see QR code for the parameter information when the parameter is selected or edited.

■ **Model information**

You can check the following model information.

- Type-Form
- Multi-rating select
- Inverter rated voltage
- Rated output capacity
- Rated output current
- CPU 1 version
- CPU 2 version
- Serial No.
- Region setting

 STOP 0.0Hz 	
Model information  16:32	
Type-Form	VFAS3-2037P
Multi-rating select	HD rating (150%-60s)
Inverter rated voltage	200V
Rated output capacity	3.70kW-5.0HP
Rated output current	18.7A
Top	Return Monitor

■ Website (QR code)

When you press the [i] key, information is displayed. For example, you can access easily from your smartphone to our website by displaying the QR code.



■ Trip information

You can check the trip information of possible causes and remedies. When you press the [F2] key, you can see QR code for troubleshooting.

When a trip occurs, the trip title and trip name blink, and the backlight of the LCD screen turns red to inform you of a trip.

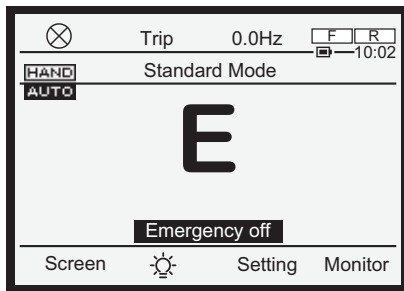

↓Press[i] key

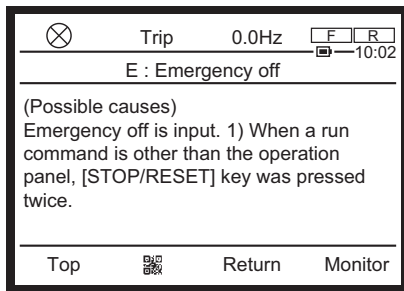

↓Press[F2] key

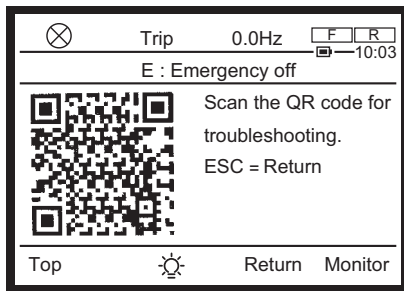

Note) If the camera cannot scan QR code because of the red screen, you can change the backlight color from red to white by pressing the [F2] key.

■ Parameter information

You can see QR code for the parameter when the parameter is selected or edited.

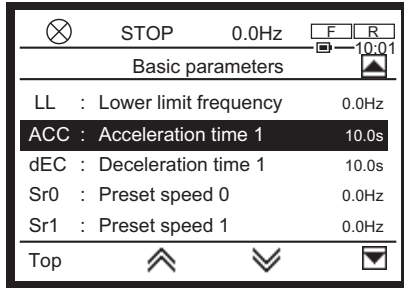

↓Press[i] key

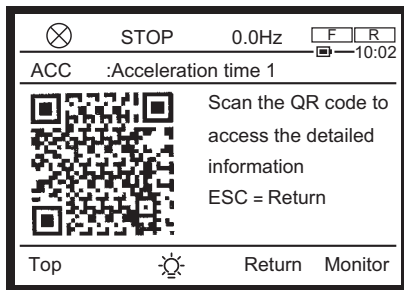

3

• [STOP/RESET] key

This key is used for a stop command from the operation panel.

To enable the stop command by this key, set "1" to the parameter <CMOD: Run command select>.

For details, refer to [5. 2. 1].

Emergency off can be applied to the inverter except when it is operated by the operation panel. When you press this key, **E0FF** blinks. When you press it again, "E" is displayed and the emergency off is applied.

For details, refer to [3. 2. 3].

It is also used as a reset key when a trip occurs. The inverter can be reset by pressing this key twice in succession when a trip occurs.

For details, refer to [3. 2. 4].

• Touch wheel

Slide your finger in a circular motion to change the menu items and values on the screen.

Turning clockwise: To move to the next item or increase the value.

Turning counterclockwise: To move to the previous item or decrease the value.

When you lightly touch the top or bottom of the circle, you can move to that direction by one item. For example, if you touch the top of the circle continuously, it works similarly to turning clockwise.

• [OK] key

This key is used to confirm the menu items and values on the screen.

■ [F1] - [F4] keys

The [F1] - [F4] keys are used to execute the items (text, symbol, icon, etc.) displayed on the lower side of the LCD screen.

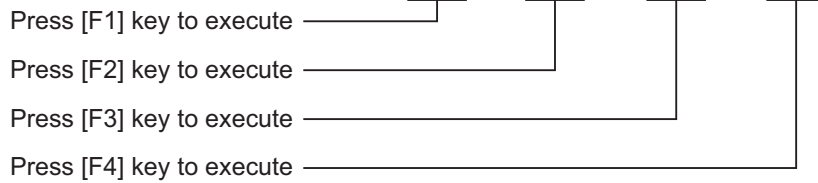
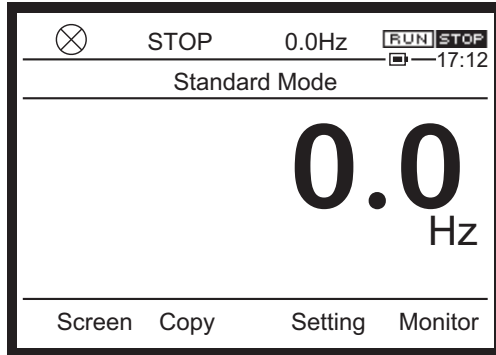

The [F1] - [F4] keys corresponding to the screen display are as follows.

Key	Screen display		Function	Reference
	Displayed position	Display		
[F1]	Left end	Screen	Sets the LCD screen	[3. 1. 3]
		Top	Displays the screen for [Standard mode]	[3. 1. 2]
		A9-- to A8--	Displays parameters of previous hundreds (A900s to A800s)	[4. 2. 1]
		F9-- to F8--	Displays parameters of previous hundreds (F900s to F800s)	[4. 2. 1]
		C9-- to C8--	Displays parameters of previous hundreds (C900s to C800s)	[4. 2. 1]
		X1000	Sets the far left number	[4. 2. 3]
[F2]	Middle left	⊗	Displays details monitor or Same as [OK] key	[3. 1. 4]
		☀	Inverts the backlight color (white or red)	[3. 2. 2]
		Language	Displays the screen for language selection	[3. 1. 3]
		←	Move setting to left	[3. 1. 3] [4. 2. 1]
		⌆	Page up (If there are more than six choices)	-
		Easy	Displays the screen for [Easy mode]	[3. 1. 2]
		Return	Same as [ESC] key (Return to the screen of [Setting mode])	-
		Change	Displays the setting screen of related parameters	[8. 1. 1]
		X100	Sets the number second from the left	[4. 2. 3]
Copy	Copy function	[3. 1. 4]		

Key	Screen display		Function	Reference
	Displayed position	Display		
[F3]	Middle right		Inverts the backlight color (white or red)	[3. 1. 3]
			Move setting to right	[3. 1. 3] [4. 2. 1]
			Page down (If there are more than six choices)	-
		R (Back)	Searches backward	[4. 2. 1]
		Setting	Displays the screen for [Setting mode]	[3. 1. 2]
		Return	Same as [ESC] key (Return to the screen of [Monitor mode])	-
		X10	Sets the number third from the left	[4. 2. 3]
[F4]	Right end	Jog	The inverter performs jog run while the key is pressed	[6. 10]
			Move setting to right	[3. 1. 4]
			Move setting to left	[3. 1. 4]
		Monitor	Displays the screen for [Monitor mode]	[3. 1. 2]
		F2-- to F1--	Displays parameters of next hundreds (F200s to F100s)	[4. 2. 1]
		C1-- to C0--	Displays parameters of next hundreds (C100s to C000s)	[4. 2. 1]
			Displays details monitor	[8. 1. 1]
		F (Next)	Searches forward	[4. 2. 1]
X1	Sets the far right number	[4. 2. 3]		

### 3. 1. 2 Display mode

This inverter has four types of display modes.

The display modes can be switched in the following two ways.

- Press the [ESC] key.
- Press any of the [F1] - [F4] keys to which the applicable display mode is assigned.

#### (1) [Standard mode]

- This is the mode that is displayed first power on.
- The operation status (output frequency of the inverter, etc) is always displayed and alarms and trips when they occur.  
In the default setting, the output frequency is displayed. The display contents can be selected with <F710: Standard mode display>.
- Setting of the panel operation frequency, EASY key function operation, language selection, and screen setting are also made in [Standard mode].

#### (2) [Setting mode]

- Parameters are set in this mode.
- All the parameters are displayed.
- [Easy mode] is also available in which only the registered parameters are displayed.

#### (3) [Easy mode]

- Parameters are set in this mode.
- In this mode, only the registered parameters are displayed.

(4) [Monitor mode]

- You can check the status such as the operation status of the inverter and terminal information.

The following are the top screen of each mode and how to switch between them.

When switching with the [F1] - [F4] keys

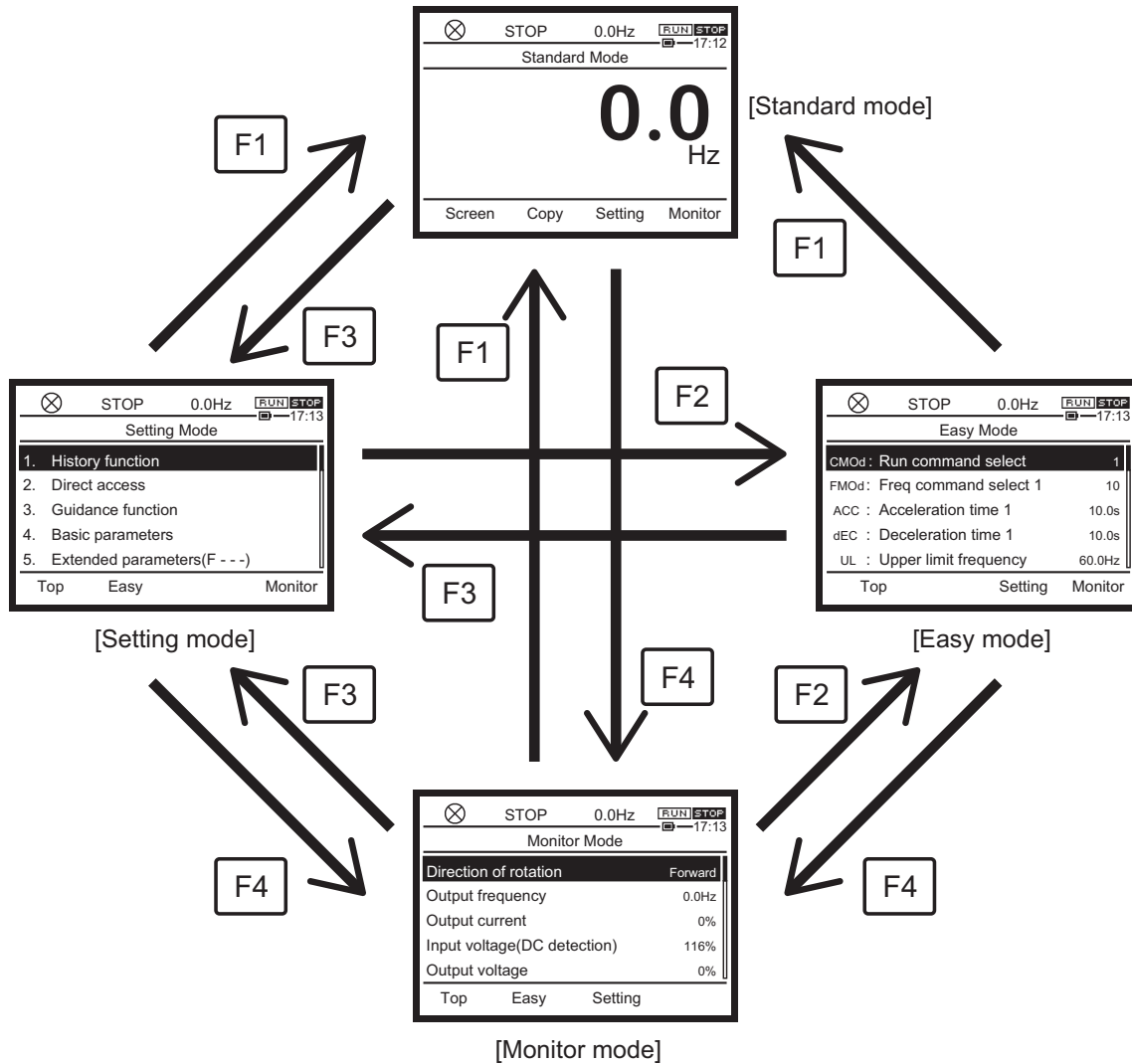

When switching with the [ESC] key

3

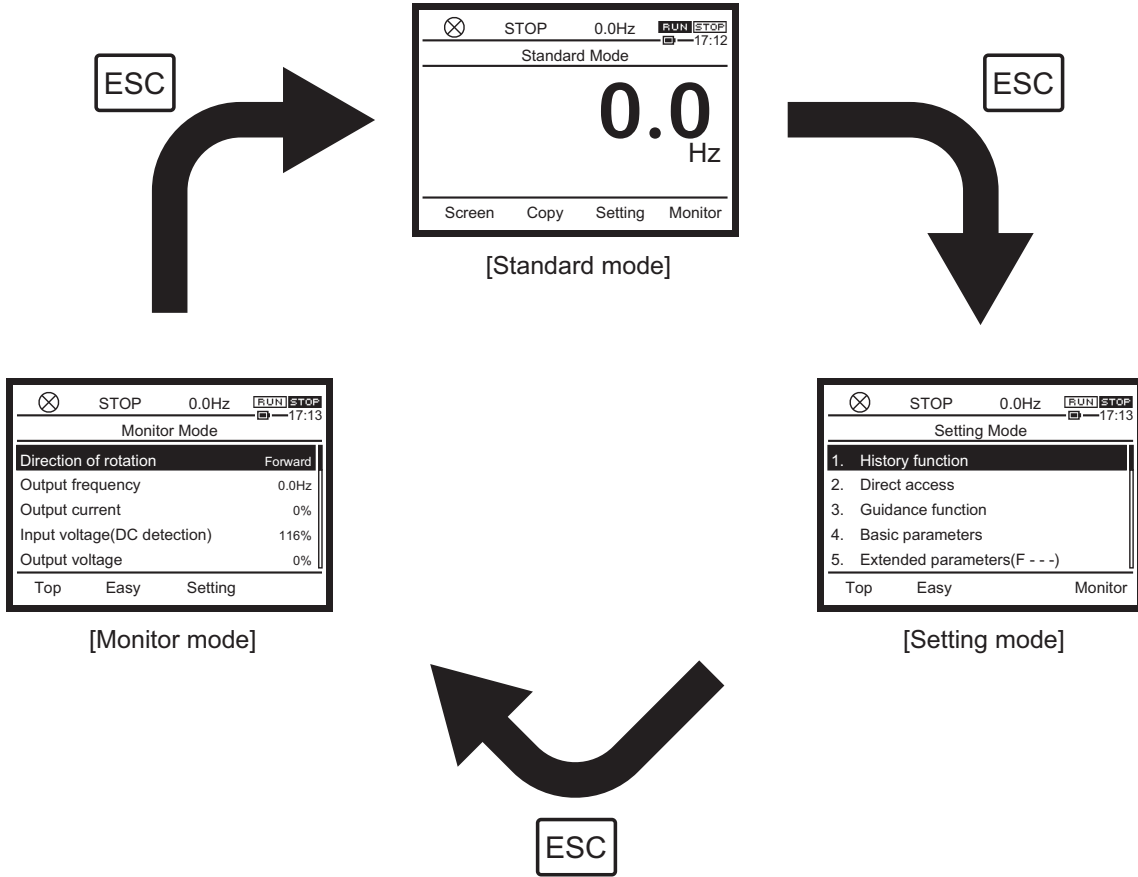

■ Screen structure

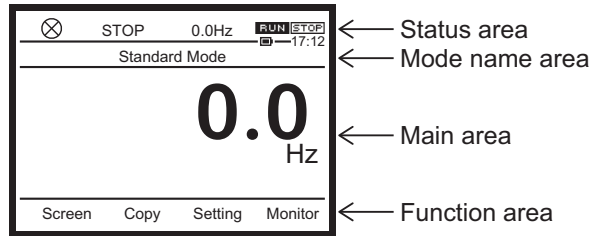



■ Screen display of [Standard mode]

This is the normal display mode of the inverter.

(1) - (6) are display contents common to [Standard mode], [Setting mode], [Easy mode], and [Monitor mode].

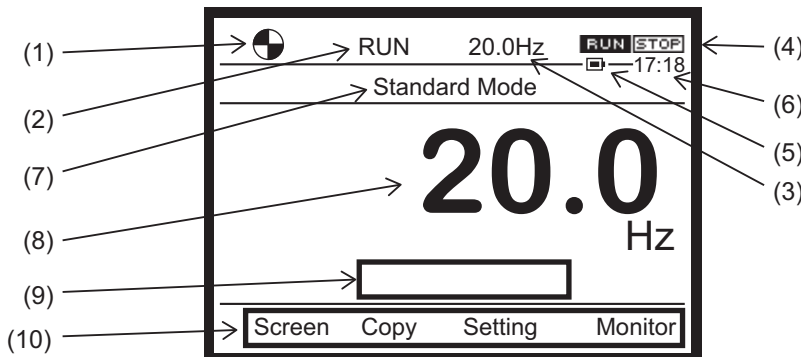

(1) The operation status is displayed with the following symbols.

⊙ (Rotating): In operation (clockwise for forward run, counterclockwise for reverse run)

⊗ : Stop

**EOFF** (Blinking): Waiting for emergency off applied with the [STOP/RESET] key (when you press the [STOP/RESET] key again while the symbol is blinking, the motor comes to an emergency off)

(2) The operation status is displayed with the following text.

"RUN": During run

"STOP": Stopped

"Trip": Trip has occurred

"JOG": In jog run

(3) The frequency command value (default setting) is displayed in Hz. Set the display contents with <F723: Status area display of operation panel>.

For details, refer to [5. 4. 3].

(4) The run commands are displayed with icons.

Run command from	Icon	Run / Stop
Terminal		Stop
		Fwd Run
		Rev Run
Operation panel, Extension panel		Stop
		Run
Embedded Ethernet		Stop
		Run
RS485 communication (connector 1)		Stop
		Run

3

Run command from	Icon	Run / Stop
RS485 communication (connector 2)		Stop
		Run
Communication option		Stop
		Run

- (5) The remaining capacity of the battery ( yes/ no) is displayed with icons.
- (6) The current time ("hour/minute") is displayed.
- (7) Current display mode [Standard mode] is displayed.
- (8) Normally, the output frequency (default setting) is displayed. Set the display contents with <F710: Standard mode display>. For details, refer to [5. 4. 3].  
When an alarm or trip occurs, its contents are displayed.
- (9) When an alarm or trip occurs, the name of the alarm and a message are also displayed here.
- (10) The functions assigned to the [F1] - [F4] keys are displayed.  
For details, refer to [3. 1. 1].

**Memo**

• When emergency off, alarm, or trip has occurred, refer to [3. 2] and [Chapter 13].

■ **Screen display of [Setting mode]**

This is a display mode to set parameters.

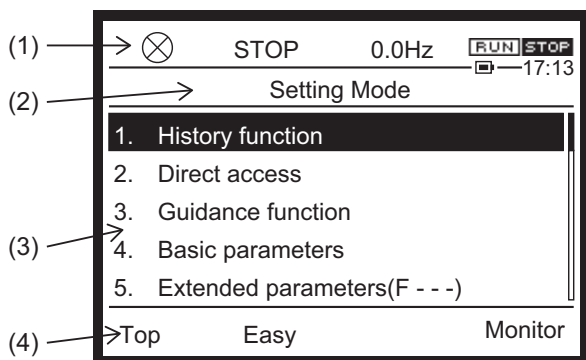

Top screen of [Setting mode]

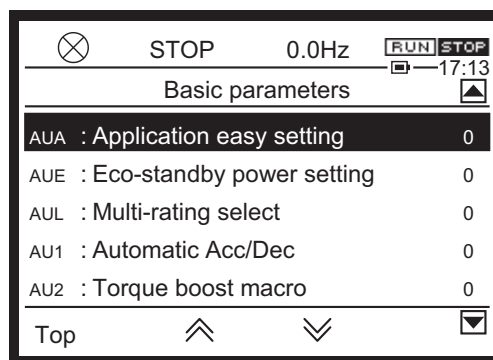

Setting screen of basic parameters

- (1) From the operation status to the current time, this mode has the same display as [Standard mode].
- (2) The current display mode [Setting mode] is displayed.
- (3) The setting items are displayed. One screen can display up to five items.  
Select an item with the touch wheel and press the [OK] key. Then the setting screen is displayed.  
<Setting screen of basic parameter>  
"Left end": Title  
"Middle": Parameter name  
"Right end": Setting value

- (4) The functions assigned to the [F1] - [F4] keys are displayed.  
For details, refer to [3. 1. 1].

■ **Screen display of [Easy mode]**

This is a display mode to set parameters easily.

It is displayed in the following cases.

- When "Easy" of the [F1] - [F3] keys is pressed in [Setting mode] and [Monitor mode]
- When [Easy mode] is set in <PSEL: Parameter mode select>

Only the parameters set in <F751: Easy setting 1> - <F782: Easy setting 32>. For details, refer to [5. 2. 8].

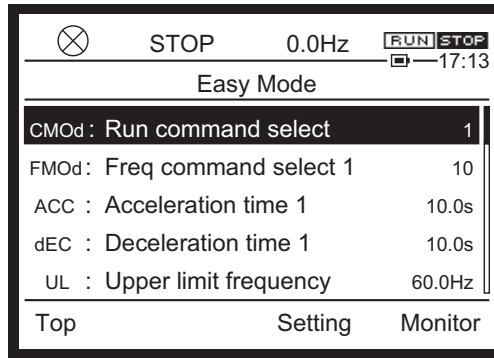

**Memo**

- For details of how to set parameters, refer to [4. 2. 3].

■ **Screen display of [Monitor mode]**

This is a display mode to monitor the inverter status (output current, input voltage, terminal information, etc.).

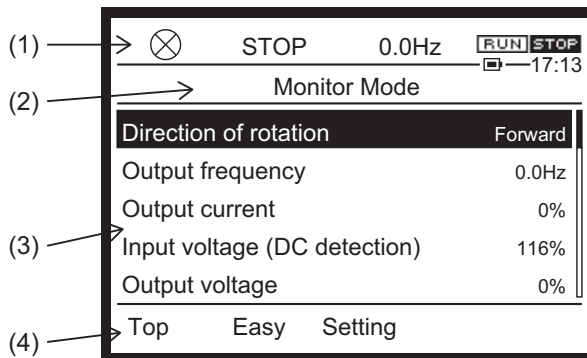

- (1) From the operation status to the current time, this mode has the same display as [Standard mode].
- (2) The current display mode [Monitor mode] is displayed.
- (3) The monitor items are displayed. One screen can display up to five items.  
"Left end": Monitor item name  
"Right end": Value, status

Furthermore, if  is displayed in the [F4] key when selecting an item with the touch wheel, detailed information is displayed when you press the [OK] key.

- (4) The functions assigned to the [F1] - [F4] keys are displayed.  
For details, refer to [3. 1. 1].

**Memo**

- For details of [Monitor mode], refer to [Chapter 8].

**3**

**3. 1. 3 Setting of LCD screen**



Important

- Note that if power off or a power failure occurs while the setting of the LCD screen is being changed, the LCD screen information is lost, and you may not be able to use the operation panel.

When you press the [F1] key ("Screen") in [Standard mode], the LCD setting screen is displayed. This screen allows various settings of the LCD screen such as selection of display language, setting of current date/time, link to the website, adjustment of contrast, and automatic off time.

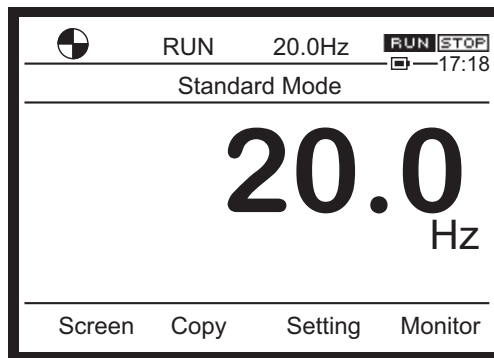

■ **LCD screen**

The following five items can be set.

- Selection of display language
- Setting of current date/time (date is displayed at the right end)
- Contrast adjustment of LCD screen (unit: %)
- Automatic off time setting of LCD screen backlight (unit: min)
- Link to website

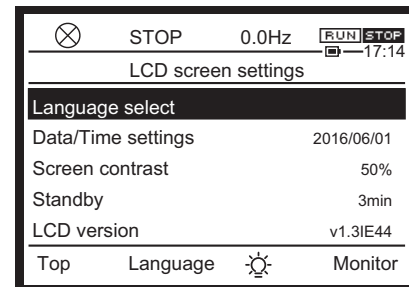

■ **Language selection**

Select a language to be displayed from the list.  
 You can select among English, German, Italian, Spanish, Portuguese, Chinese (simplified). (French and Russian are in preparation.)  
 The default setting is English.  
 A check mark is display to the right end of the selected language.

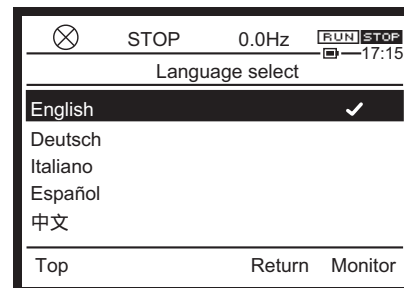

■ **Date/time setting**

Set the date and the time.  
 The time is represented in HH:MM and the date in YYYY/MM/DD.  
 Set the current time.  
 The digits that can be changed are highlighted. Press the [F2] key < or [F3] key > to shift the highlighted digits. Increase or decrease the value and press the [OK] key.

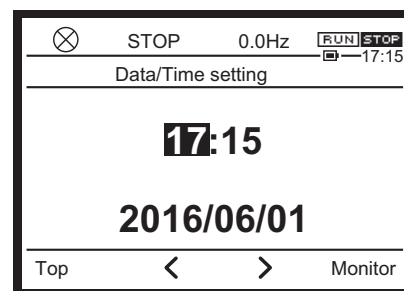

3

■ **Contrast adjustment**

The contrast can be adjusted in the range of 30 -70%.  
 The default setting is 50%.  
 If you touch the touch wheel, the value in the middle is highlighted. Increase or decrease the value and press the [OK] key.

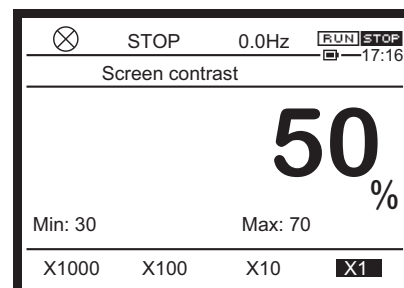

■ **Automatic off time**

The off time of the backlight can be set in the range of 0 min (always on) - 10 min (off after 10 minutes).  
 The default setting is 3 min.  
 If you touch the touch wheel, the value in the middle is highlighted. Increase or decrease the value and press the [OK] key.

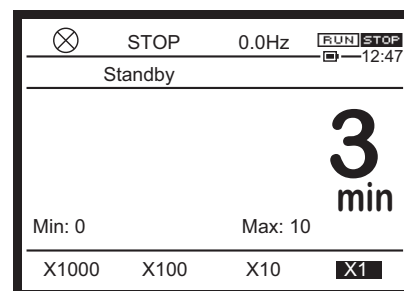

3

■ Switching of backlight color

When you press the [F3] key (☀️ mark), you can change the color of the backlight to white or red.

The color is switched every time you press the key.

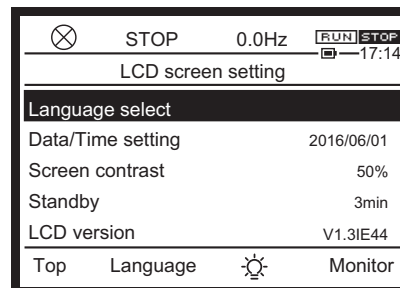

■ LCD version and Language version

You can check the version of the LCD body at the bottom of the screen.

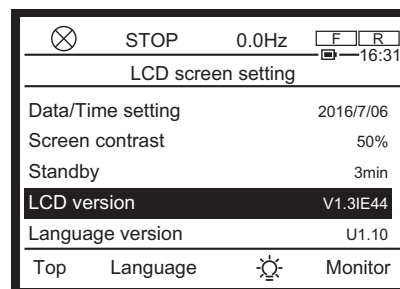

Memo

- The LCD screen can be set regardless of the setting of inhibition of parameter change with <F700: Parameter reading&writing access lockout>.

3. 1. 4 Copy function



Mandatory action

- The copy function cannot be used during run. Use this function when the inverter is stopped.
- Never turn off the power of the body or attach/remove the LCD during copying. Otherwise, the memory in the LCD may be damaged, and repair (service call) may be required.

When you press the [F2] key ("Copy") in [Standard mode], the copy function screen is displayed. The copy function allows you to upload/download the parameters of the inverter to/from the file (memory) of the LCD body.

<Limitations>

- Copying cannot be executed between inverters with different capacities.
- Re-upload the file if you want to use parameters added with version upgrade.
- Up to 16 files can be stored. Since the 17th file cannot be created, overwrite with the same file name.

**(1) Copying to LCD (uploading)**

- (1) Select "Copy to the keypad" and press the [OK] or [F2] key.

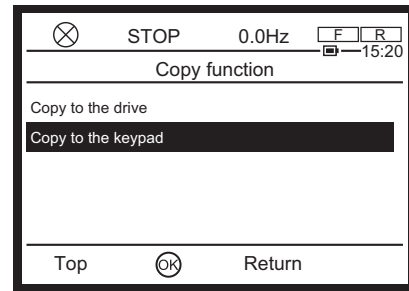

- (2) Set a figure 0 - 99 after the inverter type followed by #, and press the [OK] or [F2] key.

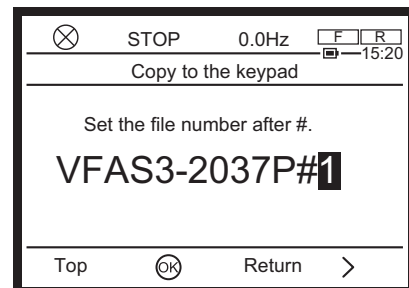

- (3) The highlighted part is the file name. In the following example, "VFAS3-2037P#1" is the file name.

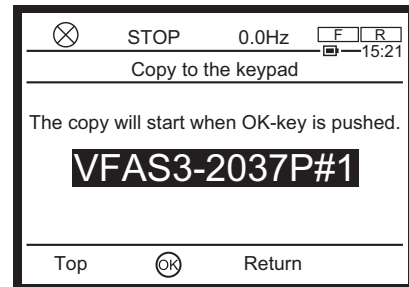

- (4) When you press the [OK] or [F2] key, copying of the parameters of the inverter body to the file (memory) of the LCD body is started.

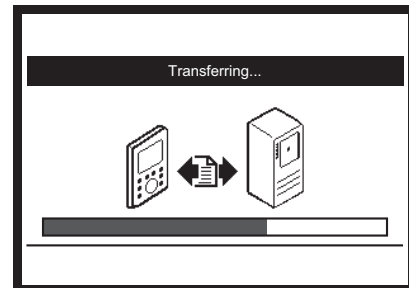

- (5) When the transfer is completed normally, the file name and CRC are displayed.

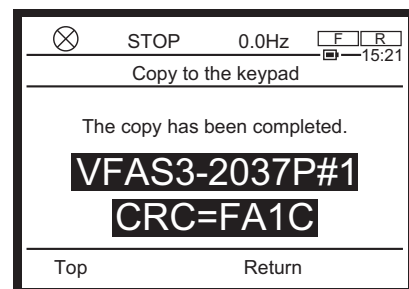

3

(2) Copying to inverter (downloading)

(1) Select "Copy to the drive", and press the [OK] or [F2] key.

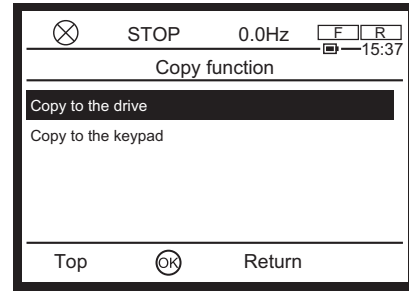

(2) Select a file to be downloaded to the inverter and press the [OK] or [F2] key.

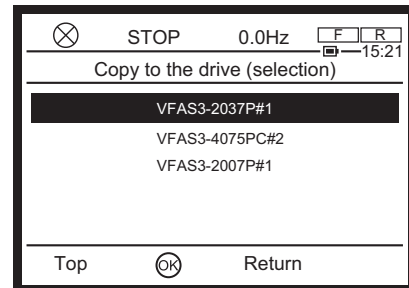

(3) The selected file is displayed.

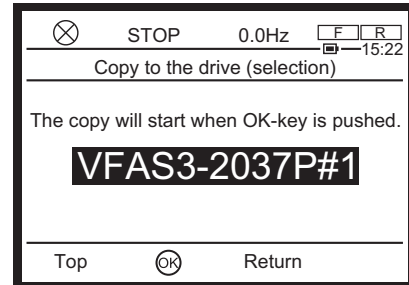

(4) When you press the [OK] or [F2] key, copying from the file (memory) of the LCD body to the parameters of the inverter body is started.

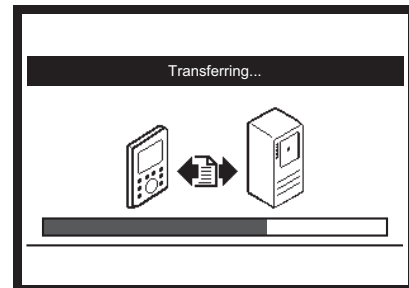

(5) When the transfer is completed normally, the file name and CRC are displayed.

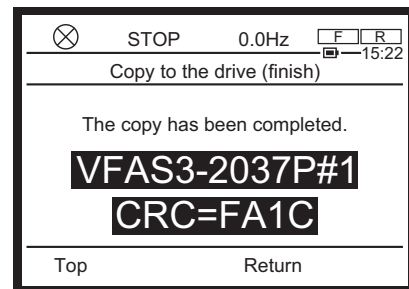



## 3.2 Normal/emergency screen display



This section explains the screen display of the operation panel.

When operation such as parameter setting is not performed, the top screen of [Standard mode] is displayed. During run, output frequency, etc. are displayed, and the status of alarm and trip is displayed when an error occurs.

### 3.2.1 Normal display

When the inverter is stopped, the screen on the right is displayed.

#### Status area

-  at the left end is stopped
- As status, "STOP" is displayed.
- The frequency command value "20.0 Hz" is displayed  
(<F723: Status area display of operation panel> = "1: Frequency command value")
- The run command is selected from operation panel, Extension panel ()

#### Main area

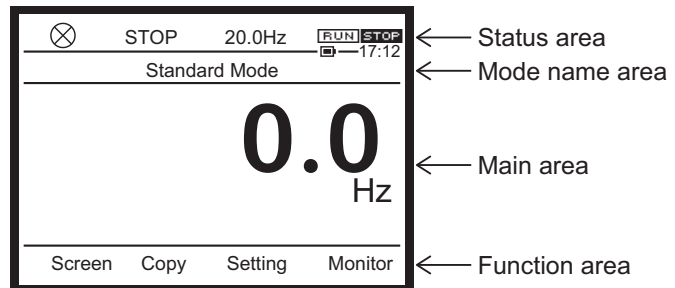

- The output frequency "0.0 Hz" is displayed (<F710: Standard mode display> = "0: Output frequency")



3

During run of the motor, the screen shown on the right is displayed.

#### Status area

-  at the left end rotates
- As status, "RUN" is displayed
- The frequency command value "20.0 Hz" is displayed  
(<F723: Status area display of operation panel> = "1: Frequency command value")
- The run command is selected from operation panel, Extension panel ()

#### Main area

- The output frequency "20.0Hz" is displayed (<F710: Standard mode display> = "0: Output frequency")

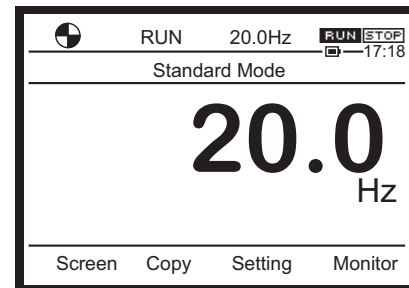

Even if [Standard mode] is switched to other display mode, you can grasp the operation status from the display in the status area.

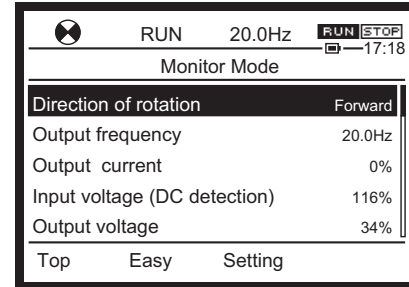

3

Reference

- When the LCD screen is dark -> Refer to [3. 1. 3]
- To check the output current, input/output voltage, etc. -> Refer to [3. 1. 2], [8. 1. 1]
- To check the setting value of the parameter -> Refer to [3. 1. 2], [4. 2]

### 3. 2. 2 Display at the time of trip

When a trip occurs, the trip title and trip name blink, and the backlight of the LCD screen turns red to inform you of a trip. Check the cause of the trip and eliminate it.

When you press the [I] key, necessary information is displayed. For details, refer to [3. 1. 1].

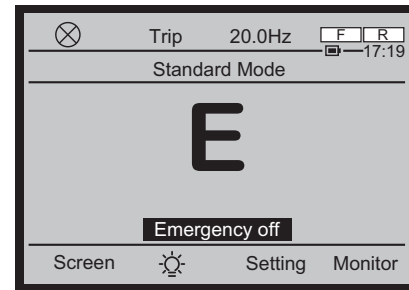

Memo

- If you want to return only the backlight from red to white, press the [F2] key.

Reference

- To reset from the operation panel -> Refer to [3. 2. 4]
- To know details of the display at the time of alarm/trip, causes, and measures -> Refer to [Chapter 13]

### 3. 2. 3 Emergency off

To apply emergency off from the operation panel except when the inverter is operated by the operation panel, follow the procedure below.

For how to apply emergency off by other than the operation panel (digital input, etc.), refer to [6. 30. 4].

- 1 Press the [STOP/RESET] key.  
**E0FF** blinks at the left end of the status area.  
 In [Standard mode], "Emergency off? (STOP) key" is displayed on the lower side in the main areas.  
 In the cases of "Setting mode" and "Monitor mode," just **E0FF** blinks.

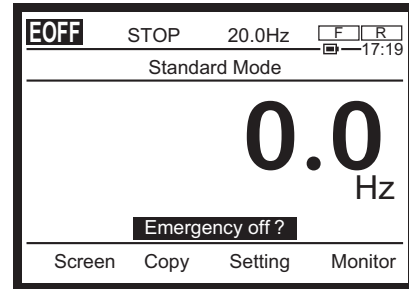

3

- 2 If you press the [STOP/RESET] key again while **E0FF** is blinking, the inverter comes to emergency off.
  - The backlight turns red, and "E" blinks.
  - "Trip" is displayed in the second position from the left of the status area.
  - "Emergency off" is displayed in the main area.

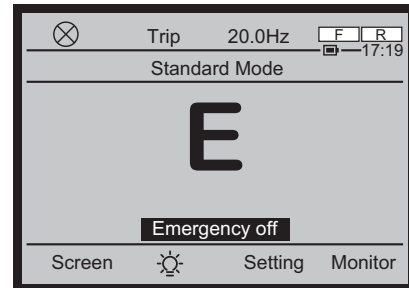

#### Memo

- The blinking **E0FF** returns to the original display status after few seconds if no operation is performed.. The inverter comes to emergency off only if you press the [STOP/RESET] key while **E0FF** is blinking.
- If you want to return only the backlight from red to white, press the [F2] key.

### 3. 2. 4 How to reset trip

If a trip occurs, you can reset it with panel operation.

For how to reset a trip by other than the operation panel (digital input, etc.), refer to [13. 1].

- 1 Press the [STOP/RESET] key with the trip displayed. "CLr" blinks in the main area, and "Reset? (STOP key)" is displayed on the lower side.
  - The backlight is red. It is white when the setting of the backlight is changed.

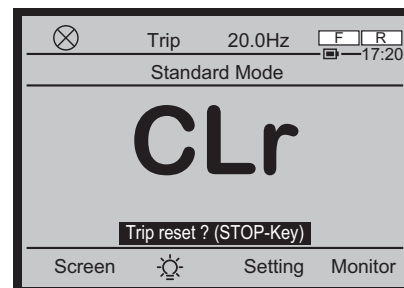

- 2 If you press the [STOP/RESET] key again while "CLr" is blinking, the trip is reset. The display on the screen once disappears, and the screen immediately after power on is displayed. The backlight returns to while.

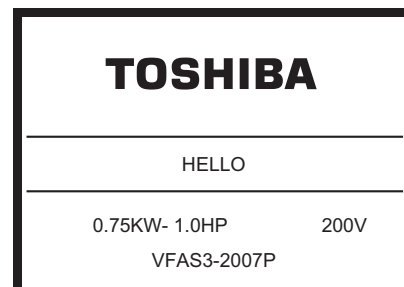

Important

- If the cause of the trip is not eliminated, a trip occurs again even after reset.
- If the trip is caused by overload protection or overheat or when pre-alarm occurs, the trip cannot be reset. For details, refer to [13. 1].

Memo

- The blinking "CLr" returns to the trip display after few seconds if no operation is performed. The trip is reset only if you press the [STOP/RESET] key while "CLr" is blinking.
- If you press keys other than the [STOP/RESET], it is considered that reset will not be done, and the screen returns to trip display.

3

# 4

## [Basic operation] Operation methods of motor

I

II



### WARNING



Prohibited

- Do not touch terminals when the inverter's power is on even if the motor is stopped. Touching the terminals while voltage is applied will result in electric shock.
- Do not touch switches when the hands are wet and do not try to clean the inverter with a damp cloth. This will result in electric shock.
- When the retry function is selected, stand clear of motors and machines at tripping stop. The motors and machines which have stopped due to tripping stop will restart suddenly, and this will result in injury. Take measures for securing safety even if the motor restarts unexpectedly, such as attaching a cover to the motor.
- Do not touch terminals or motor of the inverter while performing auto tuning. Touching the terminals or motor while voltage is applied to the terminals and motor may result in electric shock, even if the motor is stopped. After setting offline auto-tuning (F400 = "2"), execute the auto tuning at first start of the inverter. The auto tuning takes several seconds and the motor is stopped meanwhile, but voltage is applied to the terminals and motor. The motor may also generate a sound during the auto tuning, but this is not malfunction.
- Do not set the stall prevention level parameters (F601 and F185) extremely low. If the stall prevention level parameters (F601 and F185) are set at or below the motor no-load current, the stall preventive function will be always enabled and increase the frequency when it judges that regenerative braking is taking place. Do not set the stall prevention level parameters (F601 and F185) at 30% or less under normal use conditions.



Mandatory action

- Turn the power on only after mounting the front cover. When you use the inverter housed in the cabinet with the front cover removed, always close the cabinet doors first and then turn the power on. If you turn the power on with the front cover or the cabinet doors open, this will result in electric shock.
- Make sure that operation instructions are off before resetting the inverter after malfunction. If the inverter is reset while the operation instructions are on, the motor will restart suddenly, resulting in injury.
- Make sure to set the setup menu correctly. If you set the setup menu incorrectly, this will damage the inverter or cause the inverter to perform unexpected movement.
- Install circuit protection such as the mechanical brake in the crane. If there is no sufficient circuit protection installed in the crane, insufficient motor torque while auto tuning will cause the machine stalling/falling.



### CAUTION



Prohibited

- Observe all allowable operating ranges of motors and machines in use. Not observing these ranges will result in damage to motors and machines and injury. Please use motors and machines within their respective allowable operating ranges by referring to their respective instruction manuals.

1

2

3

4

5

6

7

8

9

10

11

12

13

14

15

16



Mandatory  
action

- Use the inverter that conforms to specifications of the power supply and the three-phase motor to be operated.  
If you use the inappropriate inverter, not only will the three-phase motor not rotate correctly, but it will cause serious accidents such as overheating and burning out.
- Take countermeasures against leakage current.  
The leakage current through the stray capacitance of the input/output power wires of inverter and motor can affect peripheral devices. In that case, please take countermeasures such as reducing the carrier frequency or shortening the length of input/output power wires. When the total wire length (total length between an inverter and motors) is more than 100m, if the trip occurs with the motor no-load current, make enough space between phase wires or insert the filter (MSF: motor-end surge voltage suppression filter).

The operation methods of the motor are panel run, terminal run, and communication run. In any case, parameters should be set in advance.

This chapter explains how to set parameters that are basic of motor operation.

In addition, the basic operation methods for panel run and terminal run are introduced, using examples.

## 4

### 4.1 To run/stop motor

To run/stop the motor, the following operations are required.

- Input a run command.
- Input a frequency command (motor speed).
- Input a stop command.

The operation methods of the motor are panel run, terminal run, and communication run.

To change the motor speed, control the output frequency of the inverter.

With this inverter, the run/stop command and the frequency command can be set individually.

- Set the input method of run/stop (run command) with the parameter <CMOd: Run command select>.
- Set the input method of the frequency command with the parameter <FMOD: Frequency command select 1>.

Set the method to input each command and operate with that method.



Important

- For reasons of safety, some parameters cannot be changed while the inverter is running. For details, refer to [11. 1], [11. 3].

#### ■ Panel run

On the operation panel, input run/stop (run command) and frequency command.

When you press the [RUN] key on the operation panel, the motor starts running. When you press the [STOP/RESET] key, it is stopped. Set the frequency command with the touch wheel and register it as a setting value of the parameter.

**Memo**

- For how to switch other operation method to panel run, refer to [4. 3], [5. 2. 1].

### ■ Terminal run

The motor is operated with an external signal.

Run/stop the motor with an ON/OFF signal to a digital input terminal. Also, input the frequency command with potentiometer/voltage/current signals to analog input terminals.

**Memo**

- For how to switch other operation methods to terminal run, refer to [4. 4], [5. 2. 1].

### ■ Communication run

The motor can be operated with an RS485 communication or Ethernet. Connect cables to RS485 communication connector 1 and 2 for the RS485 communication or to Ethernet connector 1 and 2 for the Ethernet communication. By inserting cassette options (PROFINET, etc.) to optional slots A, other communication run is also made possible.

For details, refer to "Communication Function Instruction Manual" (E6582143).

4

## 4. 2 Basic setting methods of parameters

This inverter has four kinds of display modes as described in [3. 1. 2]. Switch to [Setting mode] (or [Easy mode]) and set parameters.

On the setting screen of a parameter, the title, name, and setting value of the parameter are displayed. Each parameter has a 4-digit communication number assigned separately from the title.

### 4. 2. 1 [Setting mode] and [Easy mode]

Two parameter setting methods are provided.

#### [Easy mode]

- Only ten basic parameters most frequently used are displayed.
- Up to 32 parameters can be registered to be displayed.
- To set parameters not displayed in [Easy mode], set to [Setting mode] to read them out.
- Since parameters registered in [Easy mode] are directly displayed on the [Easy mode] screen, you can check or change them easily.

#### [Setting mode]

- This is a mode to set parameters of the inverter.
- All the basic parameters, extended parameters, and other parameters are displayed.

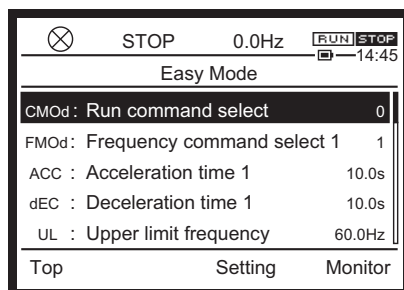
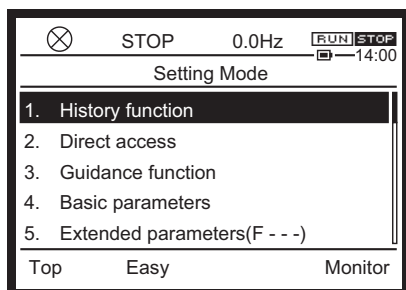

■ **How to switch [Setting mode]/[Easy mode]**

To switch between [Setting mode] and [Easy mode], switch to [Standard mode] or [Monitor mode] first.

4

**[Setting mode] -> [Easy mode]**

- Press [F2] key("Easy") at [Setting mode] or [Monitor mode]

**[Easy mode] -> [Setting mode]**

- Press [F3] key("Setting") at [Easy mode], [Standard mode] or [Monitor mode]

■ **[Setting mode]**

On the [Setting mode] screen, the following eight items are displayed.

1) **History function <AUH>**

The history of changed parameters is displayed. The latest five parameters whose settings have been changed on the operation panel can be searched automatically. It is a convenient function to immediately change parameters that have been once set or to adjust parameters by changing the setting values little by little. The changed parameters are displayed regardless of the difference from the default setting values.

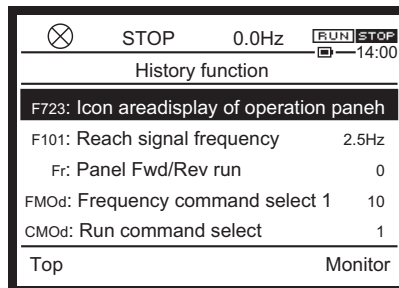

Read the history in the following procedure.

- 1 Select "1. History function" on the [Setting mode] screen and press the [OK] key. The history function screen is displayed. Up to five latest parameters that have been set or changed recently are displayed. For each parameter, the tile, parameter name, and setting value are displayed in one line.

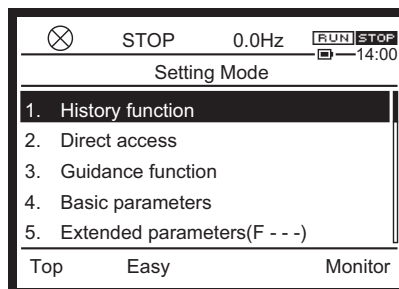



- 2 Select a parameter you want to change and press the [OK] key.  
In the example on the right, <F101: Reach signal specified frequency> is selected.

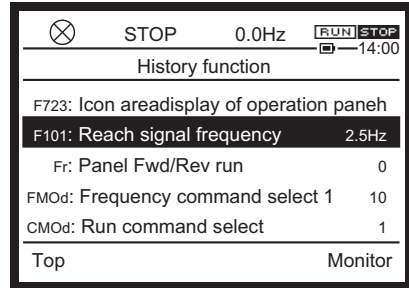

The setting screen of that parameter is opened.

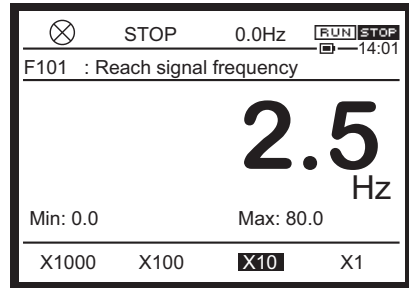

4

- 3 Change the setting of the selected parameter and press the [OK] key.

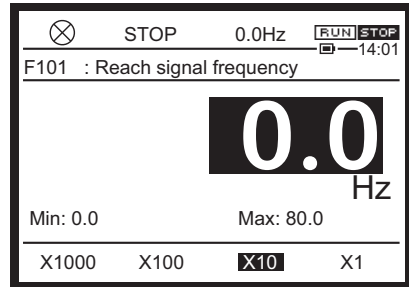

The history function screen is displayed.  
When you select the history function next time, the parameter changed most recently is displayed on the top.

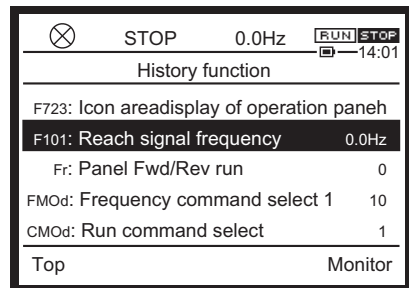

- 4 Press the [ESC] key.  
The screen returns to the [Setting mode] screen.

## Memo

- The following parameters are not displayed in the history function.
  - <FC: Panel run frequency>
  - <AUF: Guidance function>
  - <AUA: Application easy setting>
  - <AUL: Multi-rating select>
  - <AU1: Automatic Acc/Dec>
  - <AU2: Torque boost macro>
  - <SEt: Region setting check>
  - <tyP: Default setting>
  - <F699: Trip for test>
  - <F700: Parameter reading&writing access lockout>
  - <F737: Panel keys lockout>
  - <F738: Password setting>
  - <F739: Password verification>
  - <F899: Communication option reset>

## 4

## 2) Direct access

A 4-digit communication number is input to specify a parameter, and its setting screen is displayed directly.

On this setting screen, you can check or change the setting value of the parameter.

When you select "2. Direct access" on the [Setting mode] screen and press the [OK] button, the direct access screen is displayed.

A 4-digit communication number is displayed.

The selected digit is highlighted.

On the lower side of the screen, the title, name, and setting value of the parameter corresponding to the communication number are displayed.

Input the communication number in the following procedure.

## 1 Set the digit.

When you press the [F2] key ◀, the highlighted character is shifted to the left. When you press the [F3] key ▶, the highlighted character is shifted to the right.

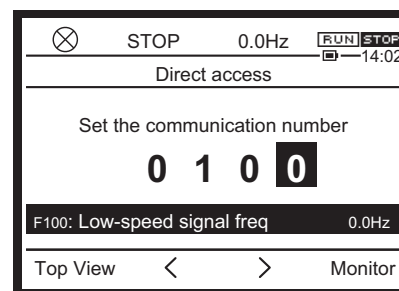
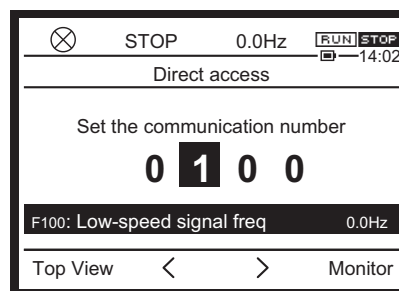

- 2 Set the value with the touch wheel.  
 The first, second, and third digits from the right are changed between "0" to "9." The fourth digit from the right is changed among "0", "A", and "C."  
 The values are carried or borrowed.  
 For example, if the third digit from the right is increased to above "0900," then "A000" is displayed and increased to "A100", "A200" and so on.

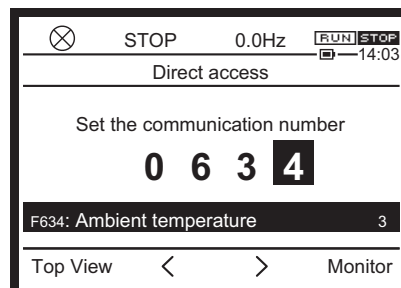

- 3 Press the [OK] key.  
 The setting screen of the selected parameter is displayed.

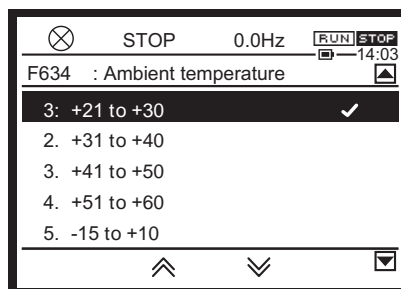

4

- 4 Press the [ESC] key.  
 The screen returns to the direct access screen.

**Memo**

- For the communication number of each parameter, refer to Chapter 11.
- For details of the concrete function and adjustment range of each parameter, refer to Chapters 5 and 6.

**3) Guidance function <AUF>**

Parameters required for a special purpose can be displayed as a group and set collectively.  
 You can set necessary parameters easily by setting parameter groups in turn that are automatically formed for special purposes.  
 Purpose-specific guidance such as Embedded Ethernet setting, Preset speed operation, Motor 1,2 switching, and Motor parameter is provided.

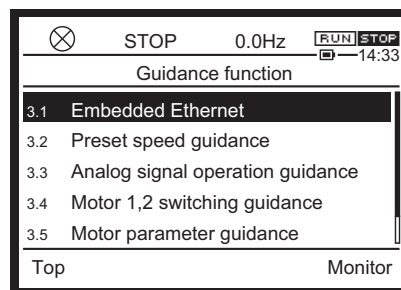

**Parameter setting**

Title	Parameter name	Adjustment range	Default setting
AUF	Guidance function	0: - 1: Embedded Ethernet setting 2: Preset speed operation 3: Analog frequency command 4: Motor 1,2 switching 5: Motor parameter 6: PM motor parameter	0

**How to use**

For example, set preset speed operation in the following procedure.

- 1 Select Guidance function "2: Preset speed operation" and press the [OK] key.

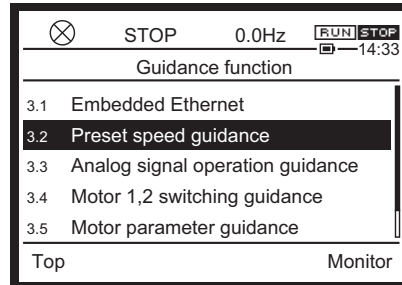

Parameters required for preset speed operation are displayed as a group.

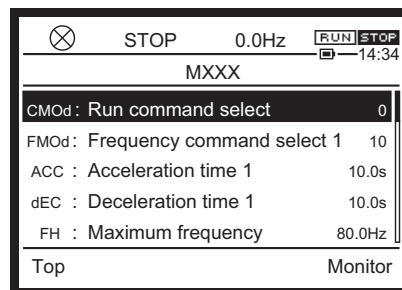

- 2 Press the [OK] key with <CMOd: Run command select> on the top of the preset speed parameter group screen selected. The selection screen of <CMOd> is displayed.

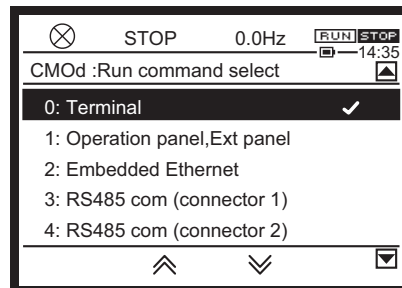

- 3 When you select <CMOd> and press the [OK] key, the screen returns to the preset speed parameter group screen. Select the next parameter <FMOd: Frequency command select 1> and press the [OK] key. By setting parameter groups similarly in turn, you can set necessary parameters easily.

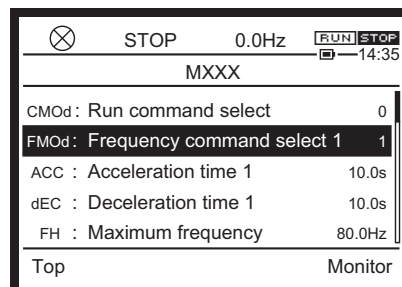

4

**List of parameters changeable by guidance function**

Embedded Ethernet setting	
<AUF>=1	
C081-C096	Device name 1-16
C610	Emb Eth. IP setting mode
C611-C614	Emb Eth. IP address setting value
C615-C618	Emb Eth. Subnet mask setting value
C619-C622	Emb Eth. Default gateway setting value
C629-C632	Emb Eth. IP address monitor
C633-C636	Emb Eth. Subnet mask monitor
C637-C640	Emb Eth. Default gateway monitor
Preset speed operation	
<AUF>=2	
CMOd	Run command select
FMOd	Frequency command select 1
ACC	Acceleration time 1
dEC	Deceleration time 1
FH	Maximum frequency
UL	Upper limit frequency
Sr1-Sr7	Preset speed 1-7
F111-F116	Terminal xx function
F287-F294	Preset speed 8-15
Analog frequency command	
<AUF>=3	
CMOd	Run command select
FMOd	Frequency command select 1
ACC	Acceleration time 1
dEC	Deceleration time 1
FH	Maximum frequency
UL	Upper limit frequency
LL	Lower limit frequency
F201	RR point 1 input value
F202	RR point 1 frequency
F203	RR point 2 input value
F204	RR point 2 frequency
F216	II point 1 input value
F217	II point 1 frequency
F218	II point 2 input value
F219	II point 2 frequency

Motor 1,2 switching	
<AUF>=4	
vL	Base frequency 1
vLv	Base frequency voltage 1
vb	Manual torque boost 1
tHrA	Motor overload protection current 1
ACC	Acceleration time 1
dEC	Deceleration time 1
F111-F116	Terminal xx function
F170	Base frequency 2
F171	Base frequency voltage 2
F172	Manual torque boost 2
F182	Motor overload protection current 2
F185	Stall prevention level 2
F415	Motor rated current
F500	Acceleration time 2
F501	Deceleration time 2
F601	Stall prevention level 1
Motor parameter	
<AUF>=5	
Pt	V/f pattern
vL	Base frequency
vLv	Base frequency voltage 1
F405	Motor rated capacity
F415	Motor rated current
F417	Motor rated speed
F400	Offline auto-tuning
PM motor parameter	
<AUF>=6	
Pt	V/f pattern
vL	Base frequency 1
vLv	Base frequency voltage 1
F402	Automatic torque boost
F405	Motor rated capacity
F415	Motor rated current
F417	Motor rated speed
F458	Current control response
F460	Speed control response 1
F461	Speed control stabilization coefficient 1
F462	Speed reference filter coefficient 1
F910	PM step-out detection current level
F911	PM step-out detection time
F912	PM q-axis inductance
F913	PM d-axis inductance
F914	Parameter for manufacturer
F915	PM control method
F916	PM starting current
F917	IPM maximum torque control
F918	IPM current phase adjustment
F919	Parameter for manufacturer
F400	Offline auto-tuning

**4) Basic parameter**

Basic parameters for inverter operation are displayed.

For details, refer to [5. 3], [5. 4], [11. 2].

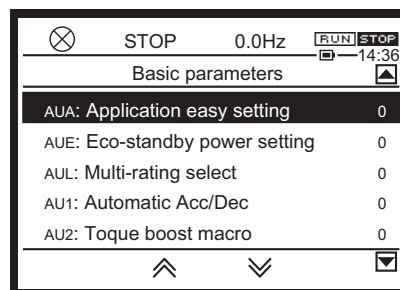

**5) Extended parameter (F---)**

Extended parameters used for complicated operation, detailed setting, and special applications, etc. are displayed.

Extended parameters are represented as "F" and a 3-digit number.

For details, refer to [5. 4], [Chapter 6], [11. 3].

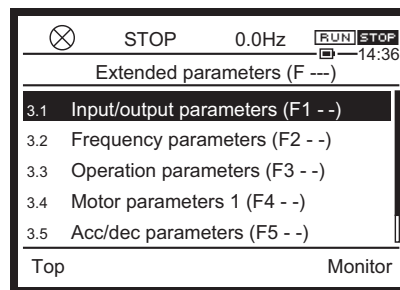

**6) Advanced parameter (A---)**

Parameters of My function, etc. that allows simplified programming are displayed.

Advanced parameters are represented as "A" and a 3-digit number.

For details, refer to [11. 4].

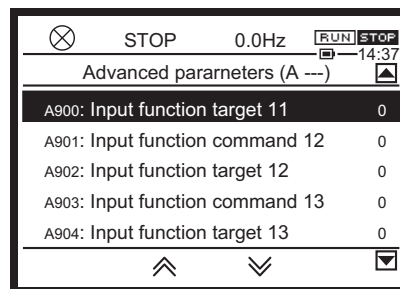

**7) Communication parameter (C---)**

Parameters with communication function are displayed.

Communication parameters are represented as "C" and a 3-digit number.

For details, refer to [11. 5].

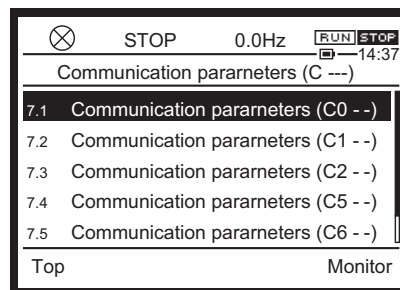

**8) Changed parameters search & edit <GrU>**

Parameters with values different from the default setting are searched, and the titles and setting values of such parameters are displayed.

The setting values of parameters can be set during search.

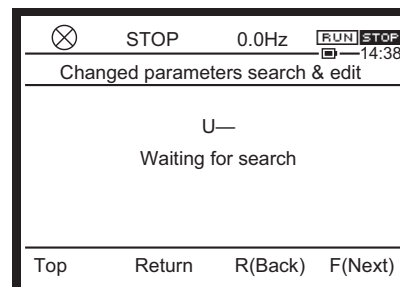

**Memo**

- Since all the parameters are compared with the default setting values, it may take a few seconds until parameters are displayed.
- To cancel parameter search, press the [ESC] key.

Read the changed parameter in the following procedure.

- 1 Select "8. Changed parameters search & edit" on the [Setting mode] screen and press the [OK] key.

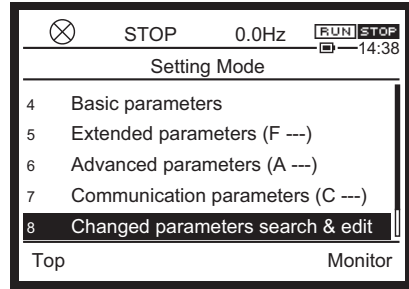

4

The Changed parameters search & edit screen is displayed. "U--- Waiting for search" is displayed in the main area.

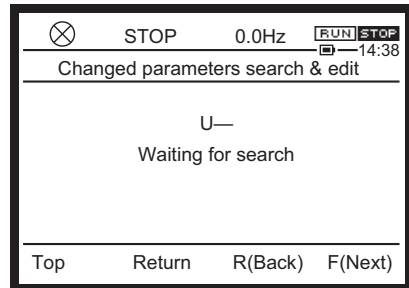

- 2 Press the [F4] key ("F(Next)"). During search, "U--F Forward searching..." is displayed. Among the changed parameters, the one with the smallest 4-digit communication number is displayed. The tile, parameter name, and setting value of the parameter are displayed.

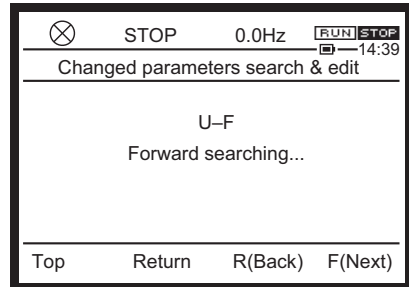

- 3 When you press the [F4] key ("F(Next)") repeatedly, the changed parameters are displayed one by one.

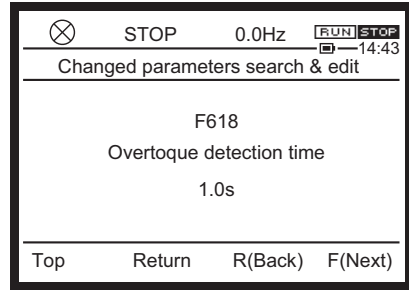

- 4 When you press the [F3] key ("R(Back)"), the changed parameters are displayed one by one from the one with the biggest communication number. During search, "U--r Reverse searching..." is displayed.

4

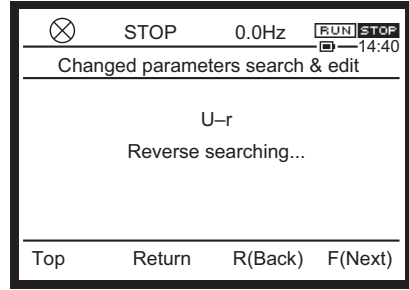

When the parameters have been searched to the last (first) one, "FIN search finish" is displayed.

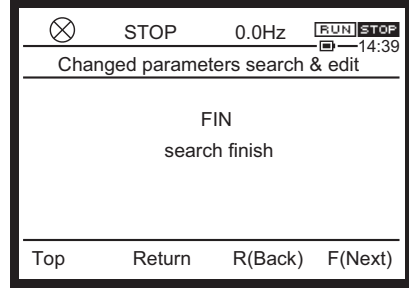

- 5 Press the [OK] key on the screen of the parameter you want to change. In the example on the right, <F618: Overtoque detection time> is selected.

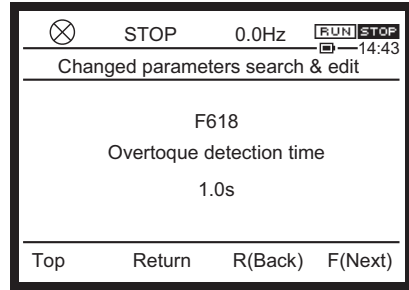



The setting screen of the parameter is opened.

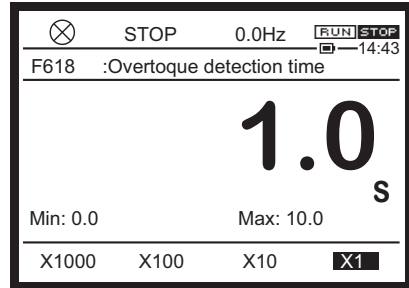

- 6 Change the setting of the selected parameter and press the [OK] key.

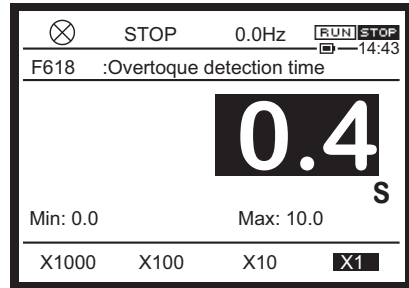

4

The Changed parameters search & edit screen is displayed. You can check that the parameter has been changed.

You can perform forward/reverse search continuously.

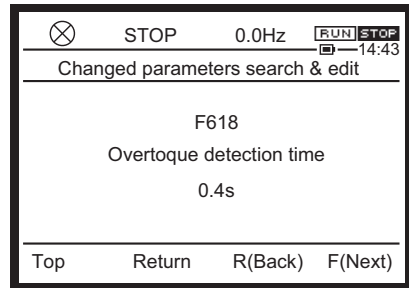

- 7 Press the [ESC] key or [F2] key ("Return"). The screen returns to the [Setting mode] screen.

Memo

- Even if the value is changed, when it is reset to the value same as the default setting, it is not displayed in Changed parameters search & edit.
- If "3" is set in <tyP: Default setting>, the parameters are all reset to the default setting. However, the values of some parameters are designed not to return to the default setting, considering maintainability. These parameters are not displayed in Changed parameters search & edit. For details of <tyP: Default setting>, refer to [5. 2. 9].



Important

- For reasons of safety, some parameters cannot be changed during run. For details, refer to [11. 2], [11. 3].

■ [Easy mode]

In [Easy mode], basic ten (default setting) parameters are displayed.  
Up to 32 parameters can be registered to be displayed.

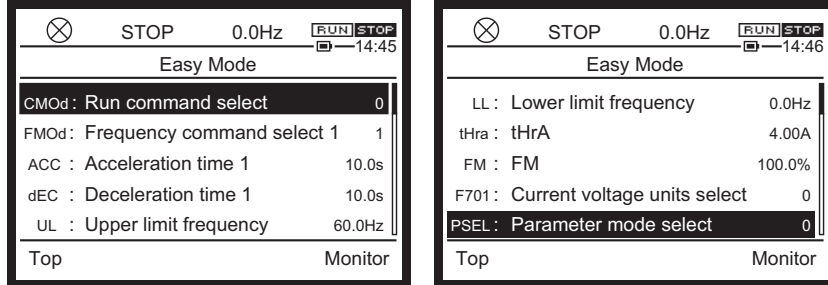

4

**<CM0d: Run command select>**

Set inputs (operation panel, terminal, communication) that give a run command to the inverter.  
For details, refer to [5. 2. 1].

**<FM0d: Frequency command select 1>**

Set inputs (operation panel, terminal, communication) that give a frequency command to the inverter.  
For details, refer to [5. 2. 1].

**<ACC: Acceleration time 1>**

Set the time that the output frequency of the inverter takes to reach <FH: Maximum frequency> from 0 Hz.  
For details, refer to [5. 2. 4].

**<dEC: Deceleration time 1>**

Set the time that the output frequency of the inverter takes to decrease to 0 Hz from <FH: Maximum frequency>.  
For details, refer to [5. 2. 4].

**<UL: Upper limit frequency>**

Set the upper limit of the output frequency.  
For details, refer to [5. 2. 3].

**<LL: Lower limit frequency>**

Set the lower limit of the output frequency.  
For details, refer to [5. 2. 3].

**<tHrA: Motor overload protection current 1>**

Set the reference current for protection with electronic thermal.  
For details, refer to [5. 2. 5].

**<FM: Terminal FM adjustment>**

Adjust the scale of the meter connected to the terminal [FM].  
For details, refer to [5. 2. 6].

**<F701: Current, voltage units select>**

Select the unit of current/voltage displayed on the operation panel among % or A (ampere)/V (volt).  
For details, refer to [5. 2. 7].

**<PSEL: Parameter mode select>**

Select the parameter mode between [Setting mode] and [Easy mode].  
For details, refer to [5. 2. 8].

## 4. 2. 2 Basic parameters and extended parameters

This inverter has basic parameters and other three types (with F, A, and C) of parameters.

**Basic parameter**

Basic parameters for inverter operation.

**Extended parameter**

Parameters used for complicated operation and detailed setting. They are represented as "F" and a 3-digit number.

**Advanced parameter**

Parameters used for My function, etc. that allows simplified programming. They are represented as "A" and a 3-digit number.

**Communication parameter**

Parameters to set communication function. They are represented as "C" and a 3-digit number.

Since <F--->, <A--->, and <C---> types includes many parameters, select them on a screen that displays parameters by the hundred and then on an individual screen.

On the selection screen of parameters, titles, parameter names, and setting values (right end) of the parameters are displayed.

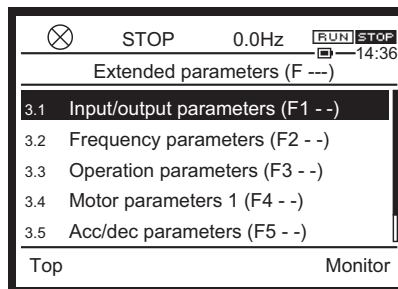
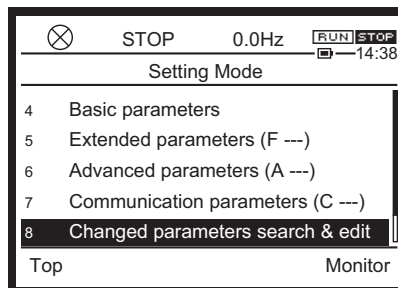

## 4. 2. 3 Basic operation of parameter setting

Set parameters in the following procedure.  
Select an item for some parameters and set a value for others.

■ **Setting of parameter for which an item should be selected**

For an example, here is a procedure to set an extended parameter <F710: Standard mode display>.

- 1 Press the [ESC] key to change from [Standard mode] to [Setting mode].

In the example on the right, the operation panel is in [Standard mode], and the output frequency is displayed in the middle of the screen.

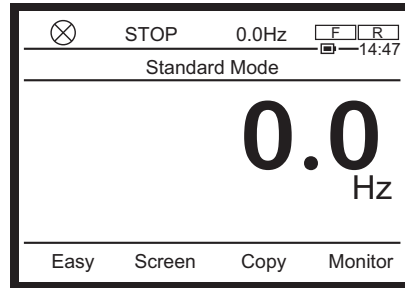

- To switch from [Monitor mode], press the [F3] key ("Setting").

- Switch from [Easy mode] to [Standard mode] or [Monitor mode]. For details of switching of display modes, refer to [3. 1. 2].

The [Setting mode] screen is displayed.

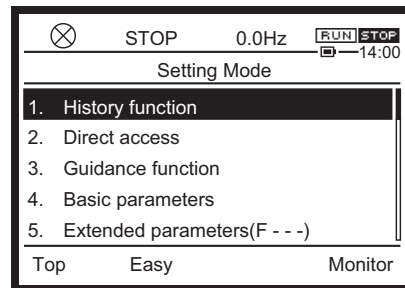

4

**Memo**

- If [Setting mode] is not displayed on the screen even after the above operation, check the <PSEL: Parameter mode select> setting. When "2: Easy mode only" is set, change the setting. For details, refer to [5. 2. 8].

- 2 Select "5. Extended parameter (F---)" with the touch wheel.

The selected item is highlighted.

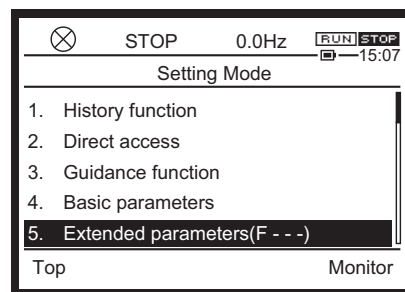

- 3 Press the [OK] key.

The extended parameter screen is displayed. The screen showing the list of each category with 100 parameters is displayed.

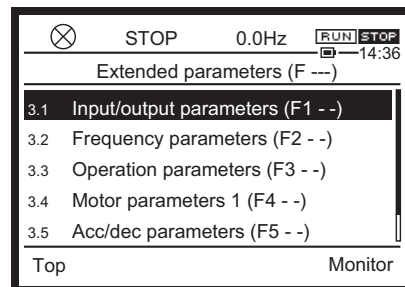

- 4 Select "3.7. Panel parameter (F7--)" with the touch wheel.

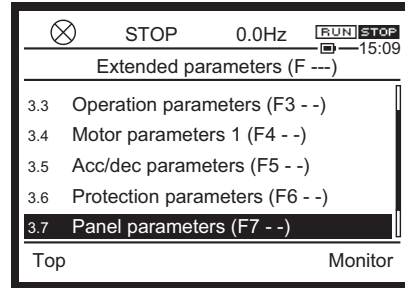

- 5 Press the [OK] key. The top screen of the parameters is displayed, starting with <F700: Parameter reading&writing access lockout>.

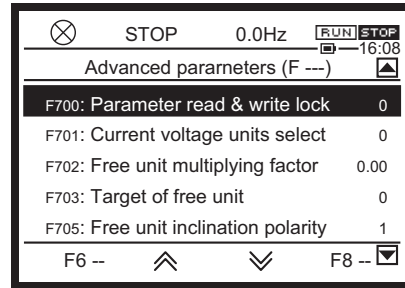

4

- 6 With the [F3] key and the touch wheel, select <F710: Standard mode display>.

The [F3] key scrolls down the screen that displays five parameters at a time page by page. The [F2] key scrolls up the screen that displays five parameters at a time page by page. The number displayed at the right end of each item is the current setting value.

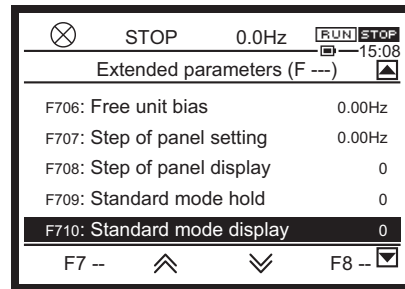

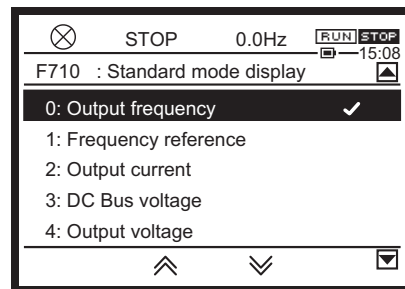

- 7 Press the [OK] key. The setting screen of <F710: Standard mode display> is displayed.

The current setting value is highlighted, and a check mark is displayed at the right end. In the example on the right, "0: Output frequency" is the current setting value.



4

- 8 Select a new setting value.  
 Select it by using the touch wheel, the [F2] key , and the [F3] key .  
 In the example on the right, the setting value is changed to "2: Output current."

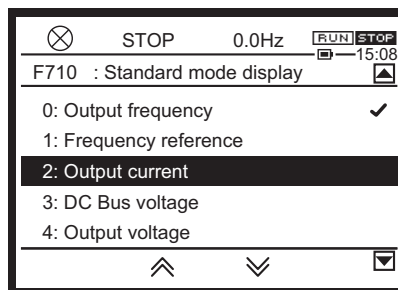

- 9 Press the [OK] key.  
 The setting value is changed. The screen display returns to the previous screen (previous one in the hierarchy), and the screen of the panel parameter is displayed.  
 Check that the number displayed at the right end of the item <F710: Standard mode display> has been changed ("0" -> "2" in the example on the right).

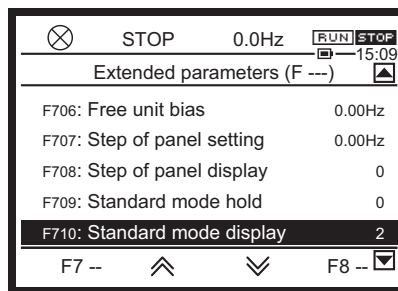

- 10 Press the [ESC] key.  
 The screen display returns to the previous one, and the extended parameter screen is displayed.

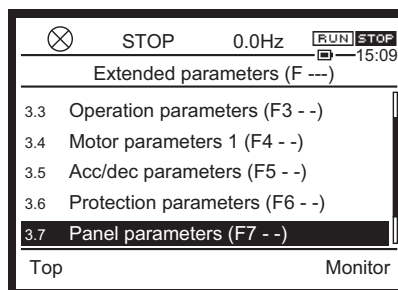

- 11 Press the [F1] key ("Standard") and return to [Standard mode].  
 In the example on the right, the display in [Standard mode] has been changed to output current (displayed in %). When you press the [F4] key/[ESC] key, the mode is switched to [Monitor mode].

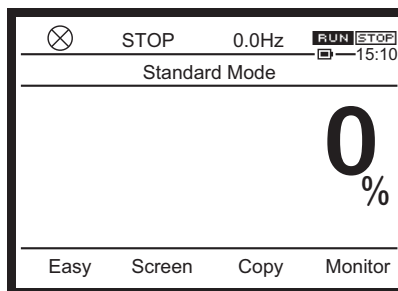

Memo

- For details of the function and adjustment range of <F710: Standard mode display>, refer to [5. 4. 3].

■ With parameters for which a value should be set

For an example, here is a procedure to set the basic parameter <ACC: Acceleration time 1>. At that time, the current setting value, unit, setting lower limit (Min:), and setting upper limit (Max:) are displayed.

- 1 Change the value with the touch wheel.  
When you touch the touch wheel, the value is highlighted, and you can change setting. When highlighted, the setting value is being changed. With the [F1] to [F4] keys, the following digits are changed.

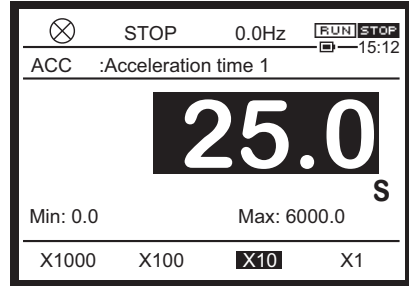

4

Key	Display	Meaning	Digit to be changed in this example
F1	x 1000	Change the digit that is the minimum digit x 1000	100 sec
F2	x 100	Change the digit that is the minimum digit x 100	10 sec
F3	x 10	Change the digit that is the minimum digit x 10	1 sec
F4	x 1	Change the minimum digit of the value displayed	0.1 sec

- 2 Press the [OK] key.  
The setting value is changed, and the screen display returns to the previous one.

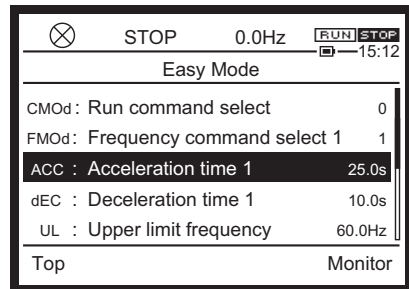

<b>Memo</b>	<ul style="list-style-type: none"> <li>• For details of the function and adjustment range of &lt;ACC: Acceleration time 1&gt;, refer to [5. 2. 4].</li> </ul>
-------------	---

## 4.3 Basic panel run methods

This section introduces panel run methods with basic examples.  
Input a run command and a frequency command from the operation panel.

### 4.3.1 [Operation example 1] Operating with [RUN] key/[STOP] key on operation panel

Operate only with the operation panel.

- First, make setting so that a run command and a frequency command can be input from the operation panel.
- Then, set a frequency command on the operation panel. The motor will rotate with this frequency.
- After setting the above, operate by using the keys on the operation panel.
- The parameters to be set are <CMOd: Run command select> and <FMOd: Frequency command select 1>.

#### Reference

- How to switch the display mode of the operation panel -> Refer to [3. 1. 2]
- Procedure to change parameter setting -> Refer to [4. 2. 3]
- Details of <CMOd: Run command select>, and <FMOd: Frequency command select 1> -> Refer to [5. 2]

- To set parameters, switch to [Setting mode].  
Select "4. Basic parameter" and press the [OK] key. The basic parameter screen is displayed.
- Select <CMOd: Run command select> and press the [OK] key.  
You can also select <CMOd: Run command select> on the [Easy mode] screen.

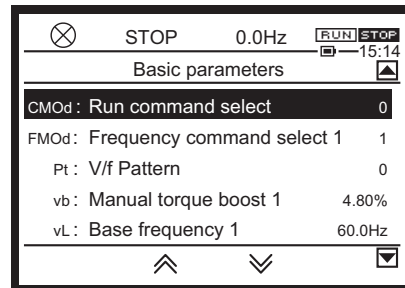
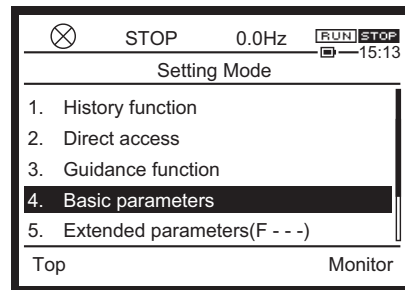



The setting screen is displayed.

- 3 Select "1: Operation panel, Extension panel" and press the [OK] key.

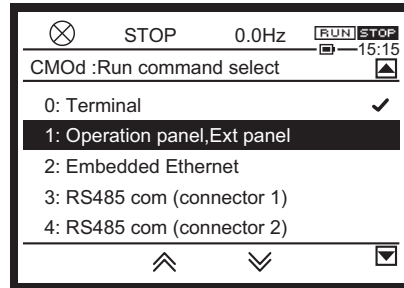
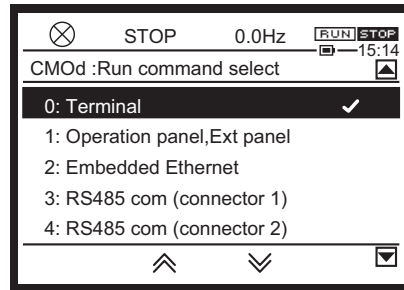

The basic parameter screen is displayed.  
Check that the setting value of <CMOd: Run command select> is "1."

- 4 Select <FMOd: Frequency command select 1> and press the [OK] key.

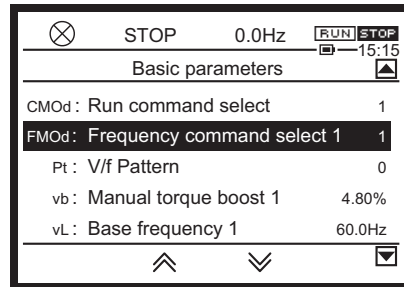
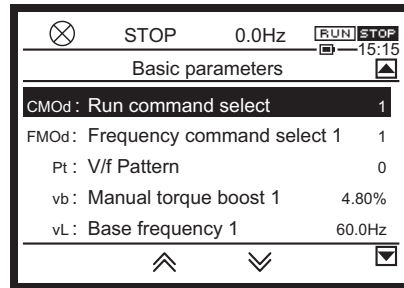

The setting screen is displayed.

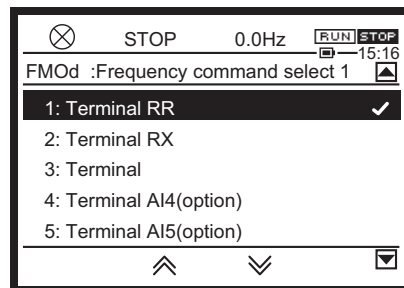

4

- Select "10: Touch wheel 1 (power off or press OK to save)" and press the [OK] key.

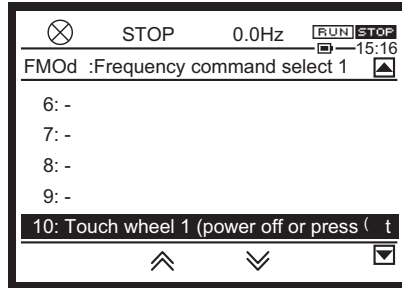

The basic parameter screen is displayed. Check that the setting value of <FMOd: Frequency command select 1> is "10".

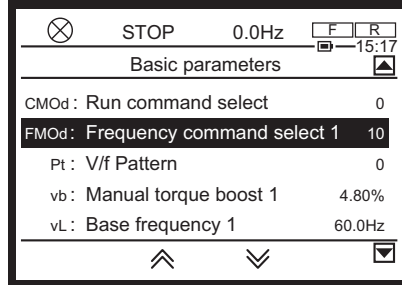

4

- Press the [ESC] key or [F1] to [F4] keys to switch to the [Standard mode] screen.
- In [Standard mode], press the [OK] key.

The setting screen of <FC: Panel run frequency> is displayed. If you leave this setting screen as it is, the screen returns to the [Standard mode] screen for a few seconds later.

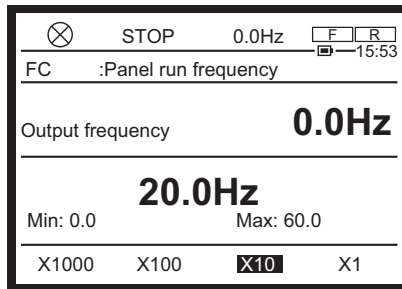

- Change the frequency command value with the touch wheel. When the setting value is changed, the value on the lower side of the screen is highlighted. In the example on the right, it is set to 30.0 Hz. This becomes the frequency command value.

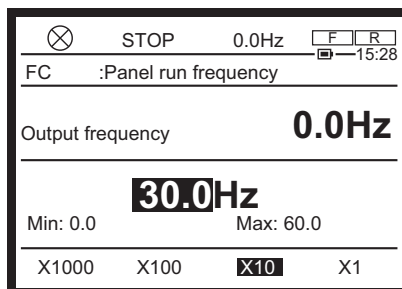

- 9 Press the [OK] key.  
The screen returns to the [Standard mode] screen.

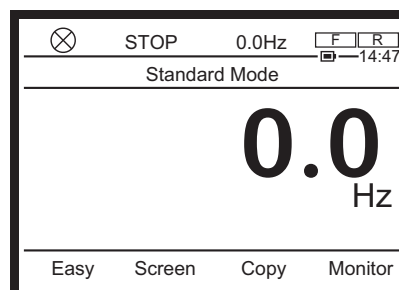

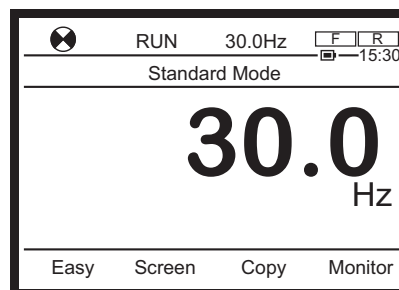

- 10 When you press the [RUN] key, the motor starts running.  
In the main area of the [Standard mode] screen, the output frequency is displayed.  
The motor accelerates according to the setting of <ACC: Acceleration time 1>, and its frequency changes to the frequency command value set with <FC: Panel run frequency> and becomes stable.  
In the example on the right, it is 30.0 Hz.



4

The following are always displayed in the status area on the upper side of the screen regardless of display mode.

(From the left)

- The  icon is rotating
- Operation status "RUN"
- Frequency command (display contents vary depending on the setting of the parameter)
- Run command icon 

### Memo

- You can change the frequency command value by pressing the [OK] key in [Standard mode] and displaying the setting screen of <FC: Panel run frequency> during run.
- When you change the frequency command value with the touch wheel, the output frequency changes accordingly.

- 11 To stop the motor, press the [STOP] key.  
The motor decelerates according to the setting of <dEC: Deceleration time 1> and stops.

## 4. 3. 2 [Operation example 2] Switching forward/reverse run with [FWD/REV] key during panel run

Switch the direction of rotation of the motor during run only by the operation panel.

- Make setting so that forward run/reverse run can be input from the operation panel.
- The parameter to be set is <Fr: Panel Fwd/Rev run select>.

Reference

- How to switch the display mode of the operation panel -> Refer to [3. 1. 2]
- Procedure to change parameter setting -> Refer to [4. 2. 3]
- Details of <Fr: Panel Fwd/Rev run select> -> Refer to [5. 3. 9]

4

- 1 Operate the motor with the operation panel according to [4. 3. 1].
- 2 Switch to [Setting mode].
- 3 Select "4. Basic parameter" and press the [OK] key.  
The basic parameter screen is displayed.

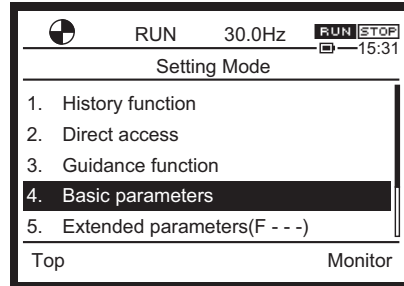

- 4 Select <Fr: Panel Fwd/Rev run select> and press the [OK] key.

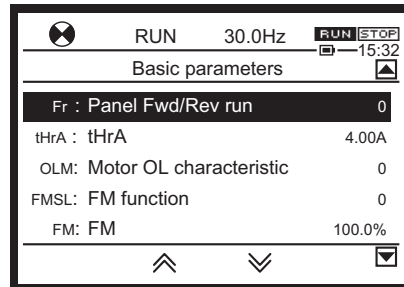

The setting screen is displayed.

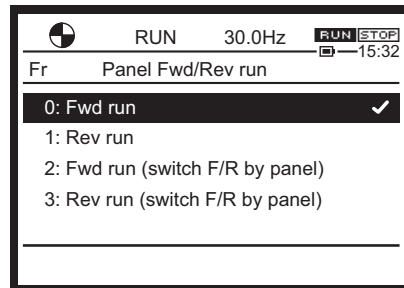

- 5 Select "2: Fwd run (switchable F/R by panel)" and press the [OK] key.

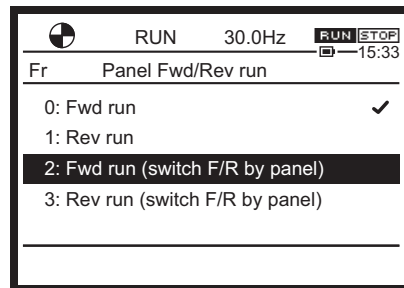

The basic parameter screen is displayed.  
Check that the setting value of <Fr: Panel Fwd/Rev run select> is "2."

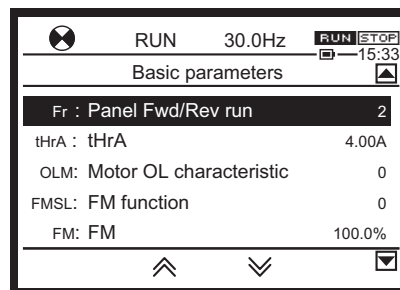

**Memo**

- When you select "1: Rev run" and press the [OK] key, the motor decelerates and starts reverse run. [FWD/REV] key operation is not possible.

6 Press the [ESC] key or [F1] to [F4] keys to switch to the [Standard mode] screen.

- Icon of direction of rotation

Only when the [FWD]/[REV] key is enabled, is displayed in the mode name area in the upper right of the screen.

When the motor is running forward, is highlighted. When it is running reversely, is highlighted.

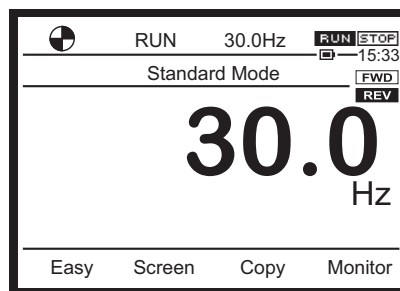

4

The following are always displayed in the status area on the upper side of the screen regardless of display mode. (From the left)

- The icon is rotating (clockwise for forward run)
- Operation status "RUN"
- Frequency command (display contents vary depending on the setting of the parameter)
- Run command icon

**Memo**

- You can also check the direction of rotation of the motor on the [Monitor mode] screen. For details, refer to [8. 1. 1].

7 When you press the [FWD/REV] key, the direction of rotation of the motor is switched to reverse run. The motor decelerates and shows 0.0 Hz once. Then, it accelerates to the frequency command value set with <FC: Panel run frequency> and becomes stable.

You can check the direction of rotation of the motor with the following display.

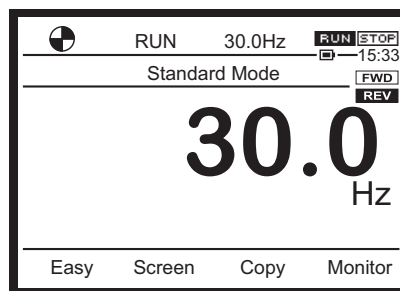

- The icon is rotating counterclockwise



- Icon of direction of rotation 

- 8 When you press the [FWD/REV] key again, the direction of rotation of the motor is switched to forward run.  
The motor decelerates and shows 0.0 Hz once. Then, it accelerates to the value set with <FC: Panel run frequency> and becomes stable.

## 4.4 Basic terminal run methods

 <b>WARNING</b>	
 Prohibited	<ul style="list-style-type: none"> <li>Do not touch terminals when the inverter's power is on even if the motor is stopped. Touching the terminals while voltage is applied will result in electric shock.</li> <li>Do not touch switches when the hands are wet and do not try to clean the inverter with a damp cloth. This will result in electric shock.</li> </ul>
 Mandatory action	<ul style="list-style-type: none"> <li>Turn the power on only after mounting the front cover. When you use the inverter housed in the cabinet with the front cover removed, always close the cabinet doors first and then turn the power on. If you turn the power on with the front cover or the cabinet doors open, this will result in electric shock.</li> </ul>

4

This section introduces terminal run methods with basic examples. Input a run command and a frequency command from a digital signal (switch/relay, etc.) or analog signal (voltage/current) from the external.

### 4.4.1 [Operation example 1] Run/stop with external signal (frequency command with operation panel)

- Input a run command externally and a frequency command from the operation panel.
- First, check connection from external contacts such as switch/relays to the control terminal. Here is a case where the operation is controlled by a switch.
  - Next, make setting so that a run command can be input externally (terminal) and a frequency command from the operation panel.
  - Then, set a frequency command on the operation panel. The motor will run with this frequency.
  - After setting the above, operate the motor by using an external switch.
  - The parameters to be set are <CMOd: Run command select> and <FMOD: Frequency command select 1>.
  - Control connection is explained in the case of sink logic.

<b>Reference</b>	<ul style="list-style-type: none"> <li>How to switch the display mode of the operation panel -&gt; Refer to [3. 1. 2]</li> <li>Procedure to change parameter setting -&gt; Refer to [4. 2. 3]</li> <li>Details of &lt;CMOd: Run command select&gt;, and &lt;FMOD: Frequency command select 1&gt; -&gt; Refer to [5. 2. 1]</li> <li>Difference of connection between sink logic and source logic -&gt; Refer to [2. 3. 5]</li> <li>Details of operation by external signals -&gt; Refer to [Chapter 7]</li> </ul>
------------------	--

4

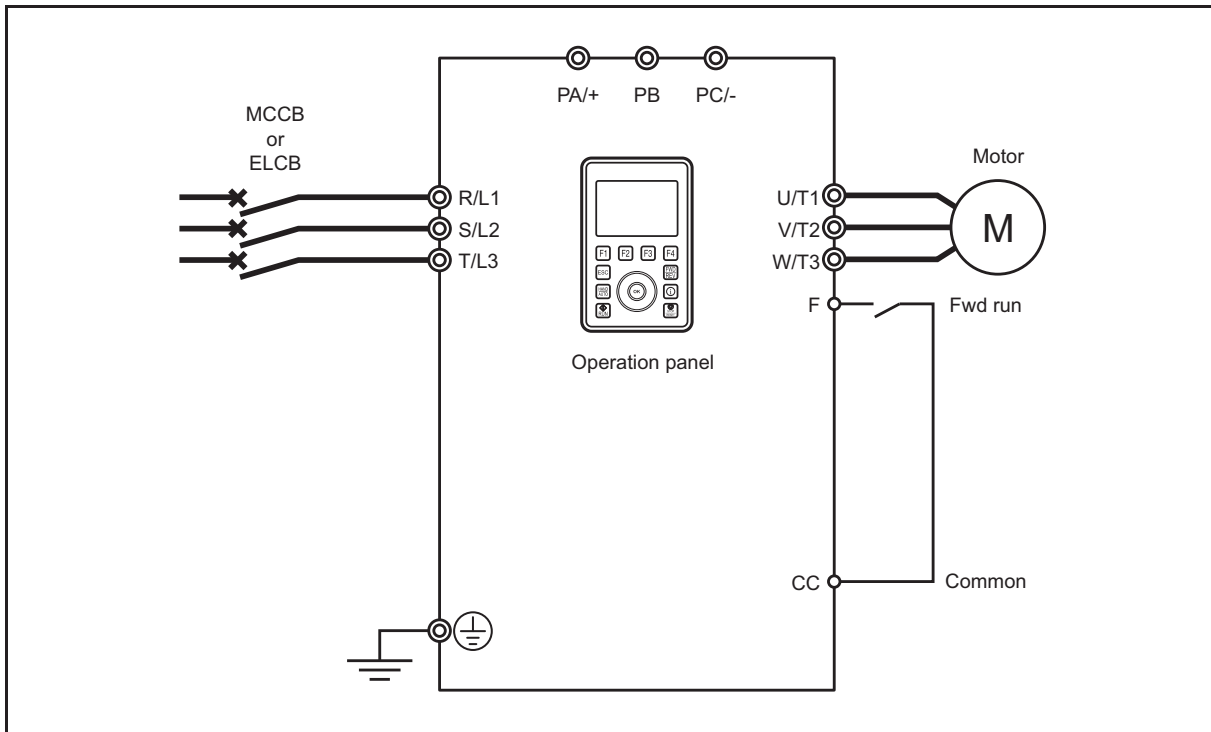

- 1 Turn off the power of the inverter.
- 2 Remove the covers of the control terminal block and parts required for connection. Covers to be removed vary depending on the type of the inverter. For details of how to remove the covers, refer to [2. 2].

- 3 Check that the slide switch [SW1] is on the SINK side. If it is set to PLC/SOURCE side, set it to the SINK side. For details of the slide switch, refer to [2. 3. 5].

- 4 Check connection between the terminal [F] and terminal [CC] of the control terminal block.

The terminal [F] is used for a forward run command in the default setting.  
For details of positions of the control terminal block and terminals, refer to [2. 3. 5].

- 5 Mount the covers. For how to mount them, refer to [2. 2].
- 6 Turn on the power of the inverter.

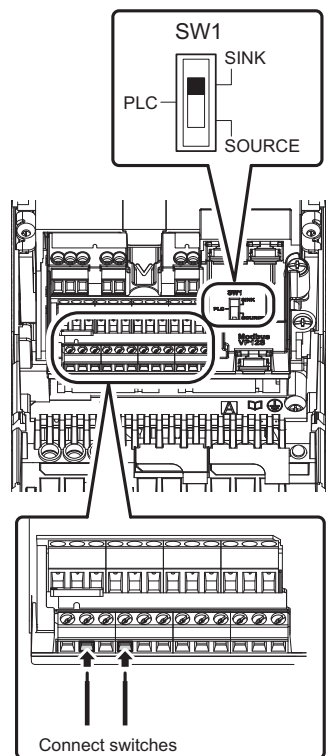



- 7 Switch to [Setting mode].  
Select "4. Basic parameter" and press the [OK] key. The basic parameter screen is displayed.

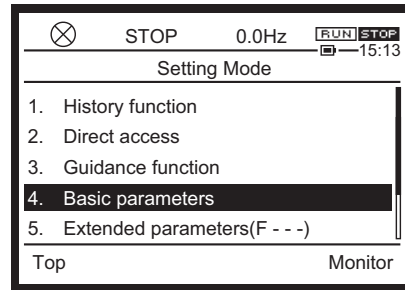

- 8 Select <CMOd: Run command select> and press the [OK] key.  
You can also select <CMOd: Run command select> on the [Easy mode] screen.

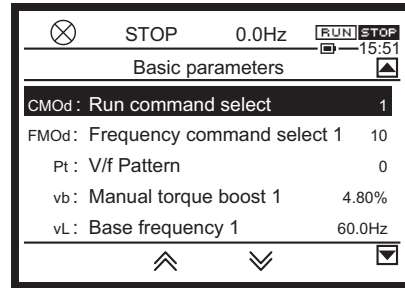

The setting screen is displayed.

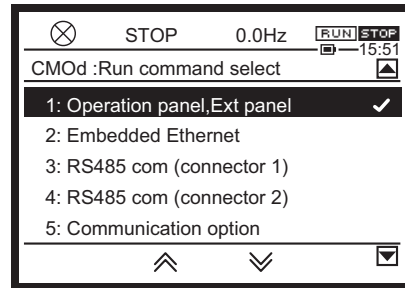

- 9 Select "0: Terminal" and press the [OK] key.

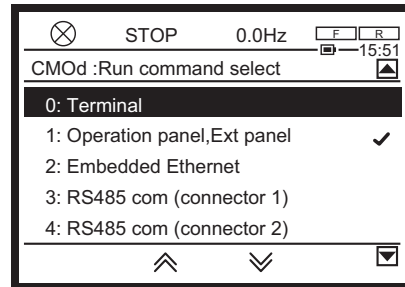

The basic parameter screen is displayed.  
Check that the setting value of <CMOd: Run command select> is "0."

- 10 Select <FMOd: Frequency command select 1> and press the [OK] key.  
The setting screen is displayed.

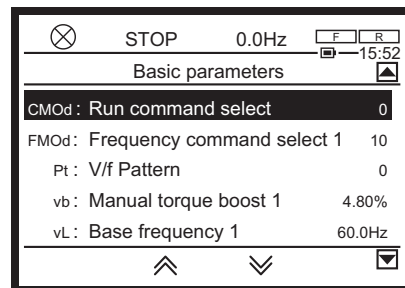

4

11 Select "10: Touch wheel 1 (power off or press OK to save)" and press the [OK] key.  
The basic parameter screen is displayed.  
Check that the setting value of <FM0d: Frequency command select 1> is "10".

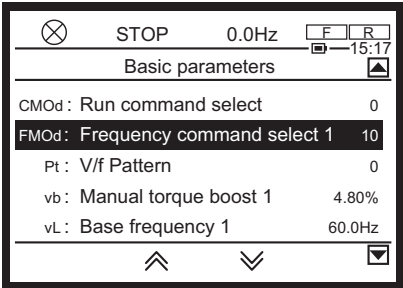

12 Press the [ESC] key or [F1] to [F4] keys to switch to the [Standard mode] screen.

13 In [Standard mode], press the [OK] key.  
The setting screen of <FC: Panel run frequency> is displayed.  
If you leave this setting screen as it is, the screen returns to the [Standard mode] screen for a few seconds later.

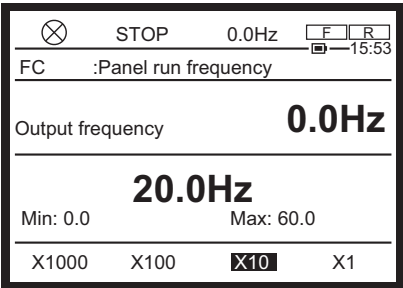

14 Change the frequency command value with the touch wheel.  
When the setting value is changed, the value on the lower side of the screen is highlighted.  
In the example on the right, it is set to 30.0 Hz. This becomes the frequency command value.

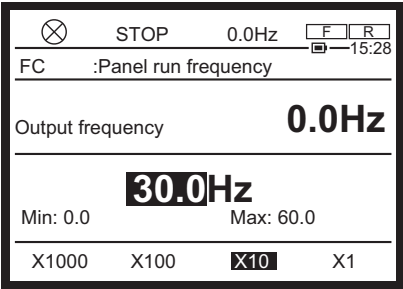

15 Press the [OK] key.  
The screen returns to the [Standard mode] screen.

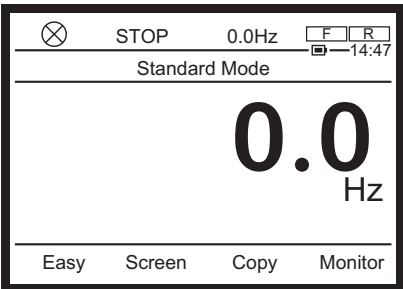



- 16 When you turn on the external switch, the motor starts running.

In the main area of the [Standard mode] screen, the output frequency is displayed.

The motor accelerates according to the setting of <ACC: Acceleration time 1>, and its frequency changes to the frequency command value set with <FC: Panel run frequency> and becomes stable.

In the example on the right, it is 30.0 Hz.

The following are always displayed in the status area on the upper side of the screen regardless of display mode. (From the left)

- The  icon is rotating
- Operation status "RUN"
- Frequency command (display contents vary depending on the setting of the parameter)
- Run command icon 

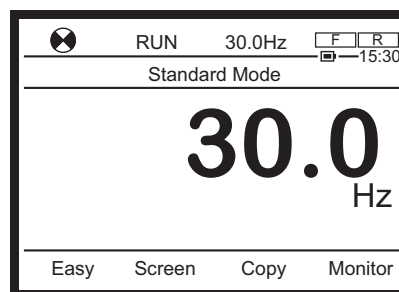

- 17 To stop the motor, turn off the external switch.

The motor decelerates according to <dEC: Deceleration time 1> and stops.

### Memo

- Reverse run of the motor can be performed by connecting an external contact (switch/relay, etc.) between the terminal [R] and terminal [CC] similarly to the procedure above. For details, refer to [Chapter 7].

## 4. 4. 2 [Operation example 2] Setting frequency with external potentiometer/analog signal

Input both run command and frequency command externally.

Set the frequency command with a potentiometer connected to outside or a voltage/current signal from outside.

- First, check connection from external contacts such as switch/relays to the control terminal. Here is a case where run/stop is input with a switch and a frequency command is input with a potentiometer (1 - 10 kΩ, 1/4 W) or voltage (0 - 10 Vdc, -10 to +10 Vdc).
- Next, make setting so that a run command and a frequency command can be input externally (terminal).
- After setting the above, operate the motor by using the external switch/potentiometer or voltage signal.
- The parameters to be set are <CMOd: Run command select> and <FMOD: Frequency command select 1>.
- Control connection is explained in the case of sink logic.

Reference

- How to switch the display mode of the operation panel -> Refer to [3. 1. 2]
- Procedure to change parameter setting -> Refer to [4. 2. 3]
- Details of <CMOd: Run command select>, and <FMOf: Frequency command select 1> -> Refer to [5. 2. 1]
- Difference of connection between sink logic and source logic -> Refer to [2. 3. 5]
- Details of operation by external signals -> Refer to [Chapter 7]

4

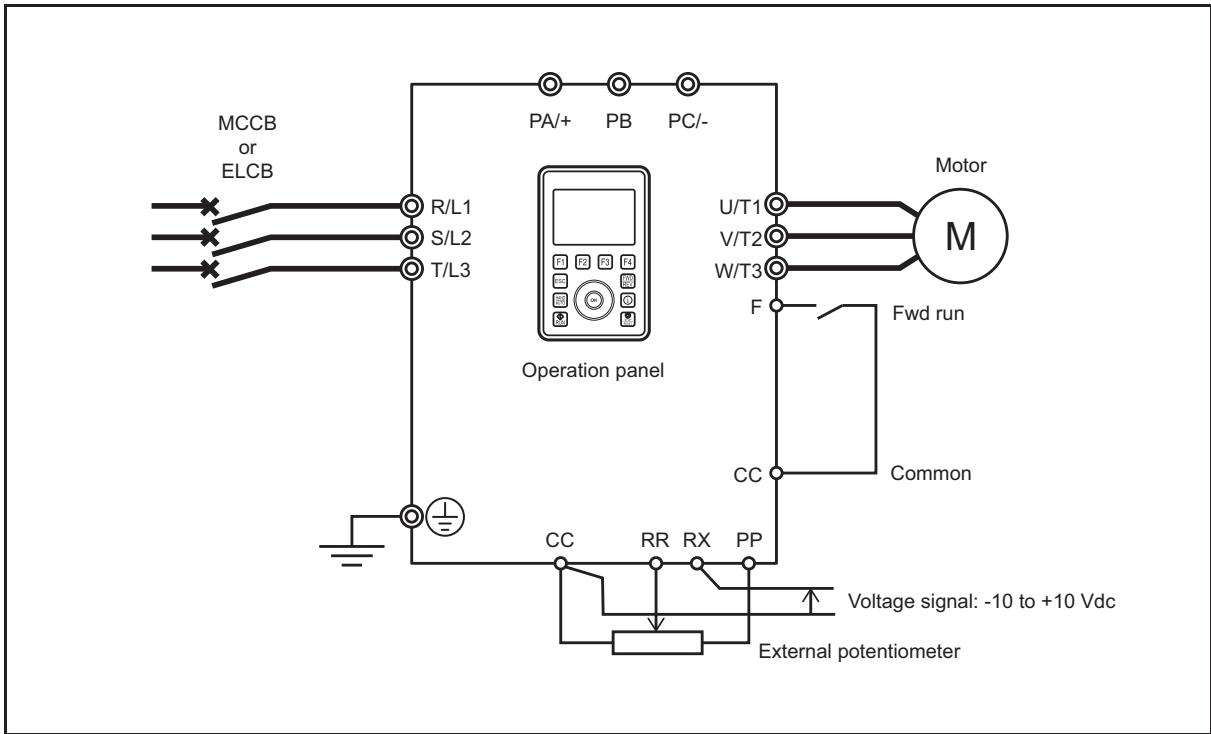

- 1 Turn off the power of the inverter.
- 2 Remove the covers of the control terminal block and parts required for connection. Covers to be removed vary depending on the type of the inverter. For details of how to remove the covers, refer to [2. 2].

- 3 Check that the slide switch [SW1] is on the SINK side.  
If it is set to PLC/SOURCE side, set it to the SINK side.  
For details of the slide switch, refer to [2. 3. 5].

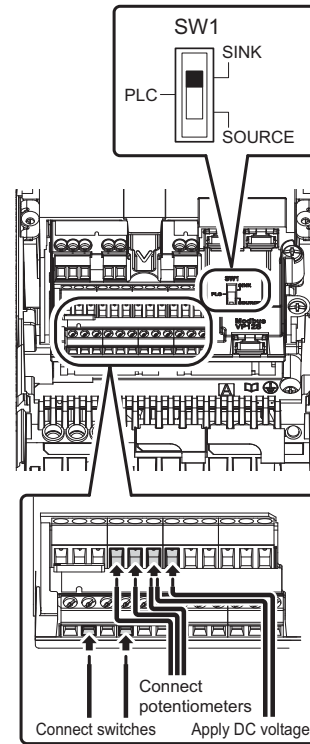

- 4 Check connection of the terminals to be used on the control terminal block.  
For details of positions of the control terminal block and terminals, refer to [2. 3. 5].

**Digital input terminals [F], [CC]**

- Connect the switch and execute forward run of the motor.

**Potentiometer input terminals [PP], [RR], [CC]**

- Connect both ends of the potentiometer to the terminal [PP] and terminal [CC], and the sliding terminal to the terminal [RR]. Rotate the potentiometer to change the frequency command.  
The terminal [PP] is used for a 10 Vdc power supply for analog input.

**Analog input terminals [RX], [CC]**

- Input 0 - 10 Vdc or -10 to +10 Vdc as a frequency command signal between the terminal [RX] and terminal [CC].

- 5 Mount the covers.  
For how to mount them, refer to [2. 2].
- 6 Turn on the power of the inverter.
- 7 Switch to [Setting mode].  
Select "4. Basic parameter" and press the [OK] key. The basic parameter screen is displayed.

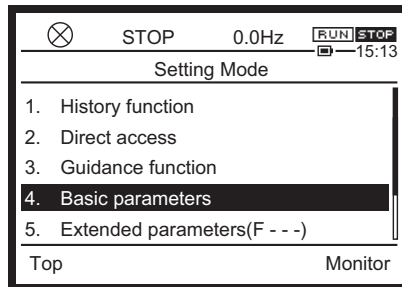

- 8 Select <CMOd: Run command select> and press the [OK] key.  
You can also select <CMOd: Run command select> on the [Easy mode] screen.

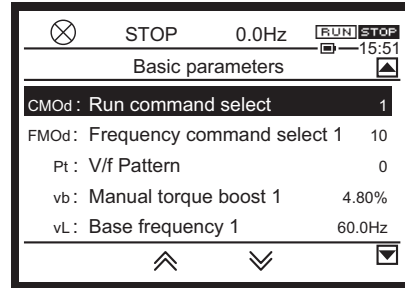

The setting screen is displayed.

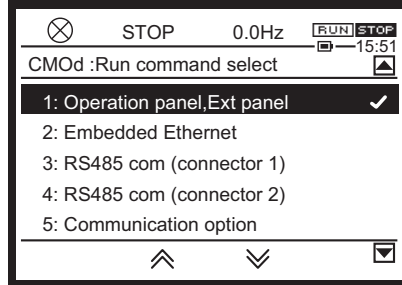

4

- 9 Select "0: Terminal" and press the [OK] key.  
The basic parameter screen is displayed.  
Check that the setting value of <CMOd: Run command select> is "0."

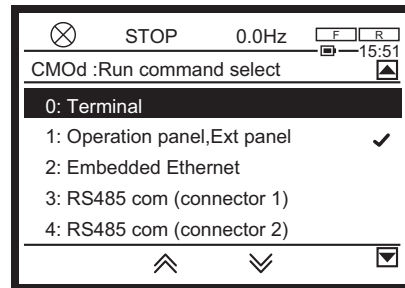

- 10 Select <FMd: Frequency command select 1> and press the [OK] key.  
The setting screen is displayed.

- 11 Select "1: Terminal RR" and press the [OK] key.

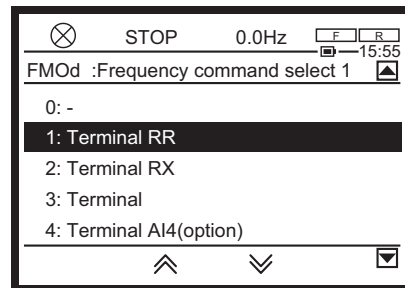

The basic parameter screen is displayed.  
 Check that the setting value of <FMOD: Frequency command select 1> is "1."  
 In this setting, the voltage signal input to the terminal [RR] should be the frequency command.  
 Here, the voltage input to the terminal [RR] is adjusted with the potentiometer.

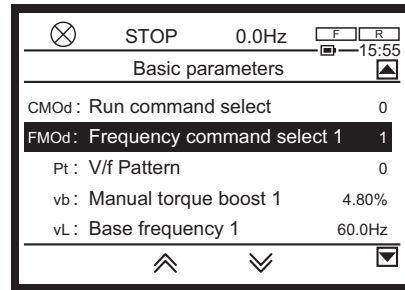

- 12 Press the [ESC] key or [F1] to [F4] keys to switch to the [Standard mode] screen.  
 In the main area of the [Standard mode] screen, the output frequency (0.0 Hz) is displayed.
- 13 Turn on the external switch.

- 14 When you rotate the potentiometer, the frequency command value increases, and the motor starts running.  
 The following are always displayed in the status area on the upper side of the screen regardless of display mode. (From the left)

- The icon is rotating
- Operation status "RUN"
- Frequency command (display contents vary depending on the setting of the parameter)
- Run command icon

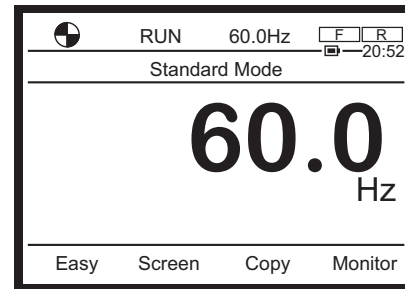
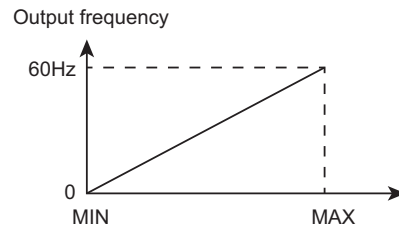
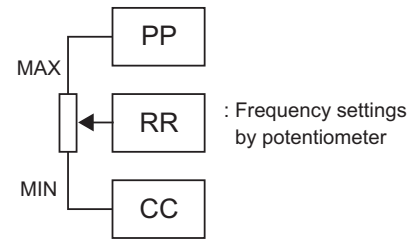

**Memo**

- In some cases, for example, when the potentiometer is set to the maximum/minimum, you can set the two frequency command points. The default setting is 0.0 Hz/60.0 Hz. For details, refer to [7. 3. 2].

- 15 When you turn off the external switch, the motor decelerates and stops.

16 In [Setting mode], change the setting value of <FM0d: Frequency command select 1> to "2: Terminal RX."

In this setting, set the frequency command with the voltage signal (0 - 10 Vdc or -10 to +10 Vdc) connected to the terminal [RX].

Even if the potentiometer is connected to the terminal [RR], a frequency command by the potentiometer is disabled.

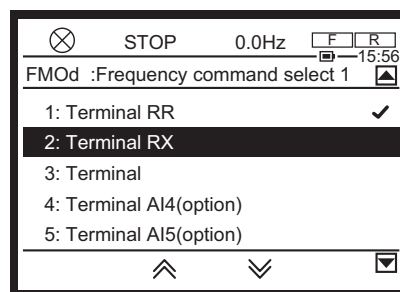

17 In [Standard mode], turn on the external switch.

4

18 When the voltage signal is increased from 0 V, the frequency command is increased, and the motor starts running.

By inputting a positive/negative voltage signal, forward run/reverse run can be switched.

The following are always displayed in the status area on the upper side of the screen regardless of display mode. (From the left)

- The icon is rotating
- Operation status "RUN"
- Frequency command (display contents vary depending on the setting of the parameter)
- Run command icon

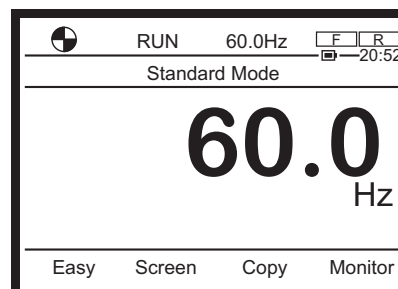
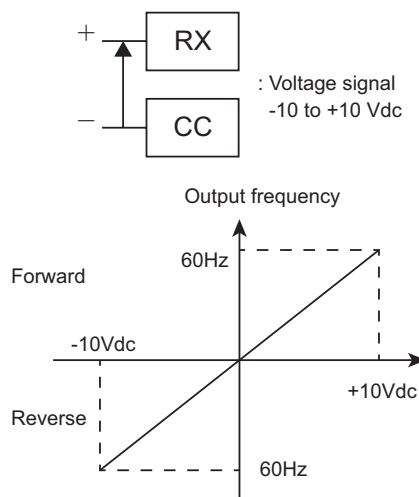

Memo

- In some cases, for example, when the voltage is set to the minimum (0 V)/maximum (+10 V), you can set the two frequency command points. The default setting is 0 V: 0.0 Hz, 10 V: 60.0 Hz. For details, refer to [7. 3. 4]. Set the input voltage to the terminal [RX] to "0: 0 - +10 V" or "1: -10 to +10 V" with <F107: Terminal RX input voltage select>.



19 When you turn off the external switch, the motor decelerates and stops.

**Memo**

- You can also change the input specification of the terminal [RR] to PTC input, etc. For details, refer to [6. 2. 3].

### 4. 4. 3 [Operation example 3] Switching run/stop and frequency with external switch

Digital input both a run command and a frequency command externally.

- First, check connection from external contacts such as switch/relays to the control terminal.
- Here is a case where run/stop is input by a switch and a frequency command is operated by 3-speed operation (controlled with two relays).
- Next, make setting so that a run command and a frequency command can be input externally (terminal).
- After setting the above, operate the motor by using the external switch or external signal.
- The parameters to be set are <CMOd: Run command select>, <Sr1: Preset speed 1>, <Sr2: Preset speed 2>, and <Sr3: Preset speed 3>.
- Control connection is explained in the case of sink logic.

## 4

## Reference

- How to switch the display mode of the operation panel -> Refer to [3. 1. 2]
- Procedure to change parameter setting -> Refer to [4. 2. 3]
- Details of <CMOd: Run command select> -> Refer to [5. 2. 1]
- Difference of connection between sink logic and source logic -> Refer to [2. 3. 5]
- Details of operation by external signals -> Refer to [Chapter 7]

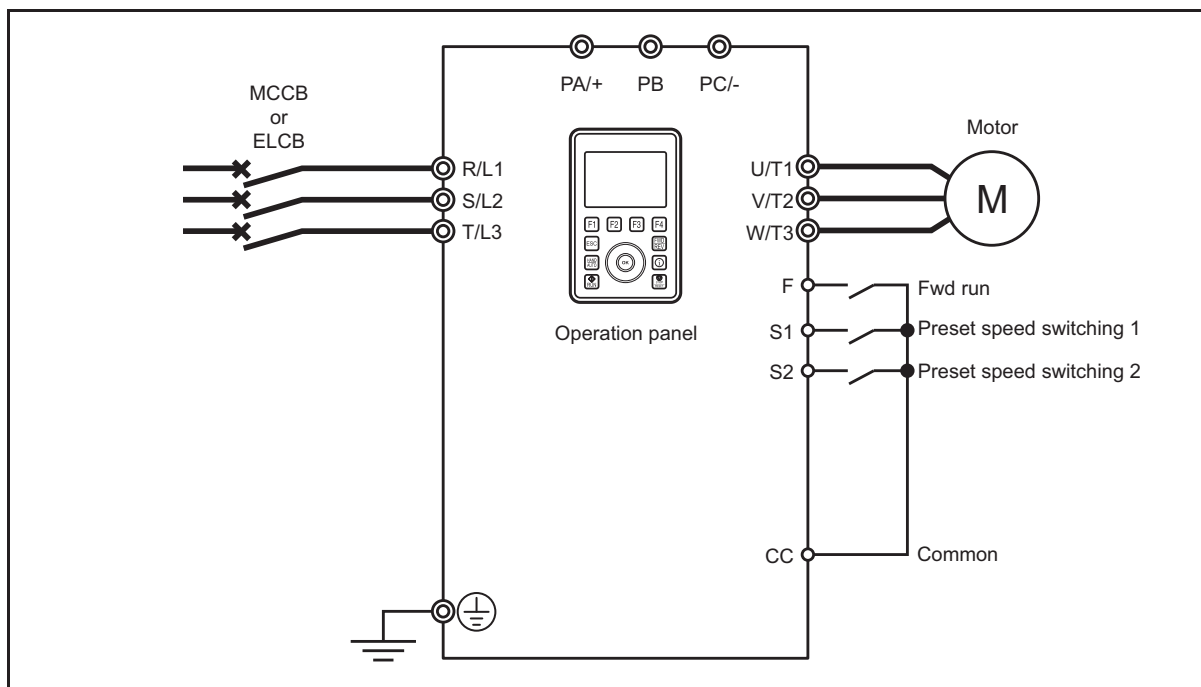

- 1 Turn off the power of the inverter.
- 2 Remove the covers of the control terminal block and parts required for connection. Covers to be removed vary depending on the type of the inverter. For details of how to remove the covers, refer to [2. 2].

- 3 Check that the slide switch [SW1] is on the SINK side.  
If it is set to PLC/SOURCE side, set it to the SINK side.  
For details of the slide switch, refer to [2. 3. 5].

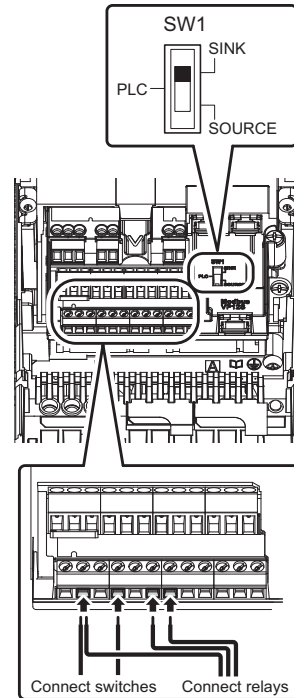

4

- 4 Check connection of the terminals to be used on the control terminal block.  
  
For details of positions of the control terminal block and terminals, refer to [2. 3. 5].

**Digital input terminals [F], [CC]**

- Connect the switch and execute forward run of the motor.

**Digital input terminals [S1], [CC]**

- Connect relay 1 to perform preset speed operation.

**Digital input terminals [S2], [CC]**

- Connect relay 2 to perform preset speed operation.

**Memo**

- With combination of relay 1 ON, relay 2 ON, and both relay 1 and relay 2 ON, you can set three types of frequency command values.

- 5 Mount the covers.  
For how to mount them, refer to [2. 2].
- 6 Turn on the power of the inverter.
- 7 Switch to [Setting mode].
- 8 Select "4. Basic parameter" and press the [OK] key.  
The basic parameter screen is displayed.

4

- 9 Select <CMOD: Run command select> and press the [OK] key.

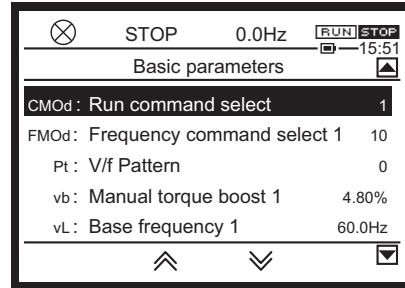

The setting screen is displayed.

- 10 Select "0: Terminal" and press the [OK] key. The basic parameter screen is displayed. Check that the setting value of <CMOD: Run command select> is "0."

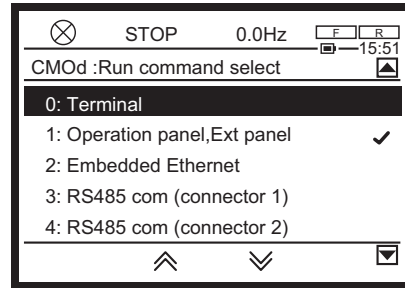

- 11 Select <Sr1: Preset speed 1> and press the [OK] key. The setting screen is displayed. The default setting is 0.0 Hz.

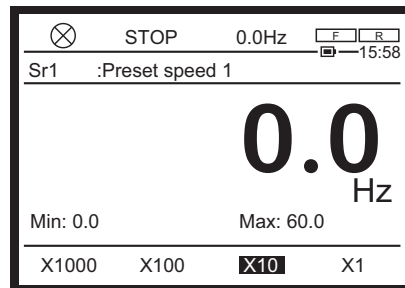

- 12 Change the setting value with the touch wheel. When the setting value is changed, the value on the screen is highlighted. In the example on the right, it is set to 20.0Hz. This is the frequency command value of Preset speed 1.

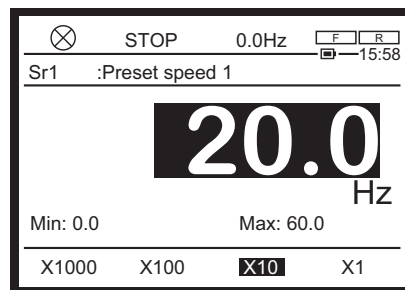

- 13 Press the [OK] key.  
The screen returns to the basic parameter screen.

- 14 Similarly, select <Sr2: Preset speed 2> and <Sr3: Preset speed 3> and change the setting values.

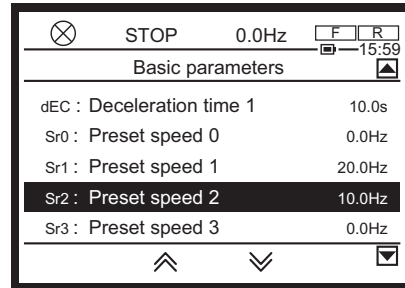

4

In the example on the right, <Sr2: Preset speed 2> is set to 10.0 Hz and <Sr3: Preset speed 3> to 15.0 Hz.

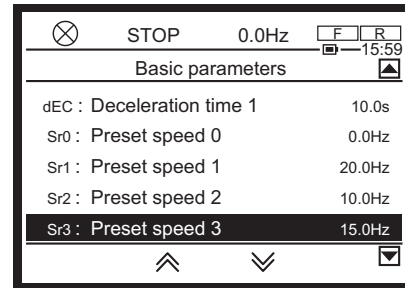

- 15 Press the [OK] key to return to the basic parameter screen.
- 16 Turn on the external switch.  
Leave the two relays off.
- 17 When you turn on relay 1, the frequency command value of <Sr1> is enabled, and the motor starts running.  
In the main area of the [Standard mode] screen, the output frequency is displayed.

The output frequency changes to the frequency command value set with <Sr1: Preset speed 1> and becomes stable.

In the example on the right, it is 20.0 Hz.

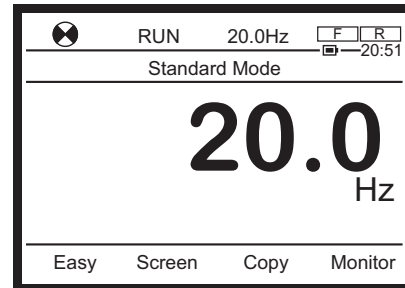

The following are always displayed in the status area on the upper side of the screen regardless of display mode. (From the left)

- The icon is rotating
- Operation status "RUN"
- Frequency command (display contents vary depending on the setting of the parameter)
- Run command icon

Output frequency

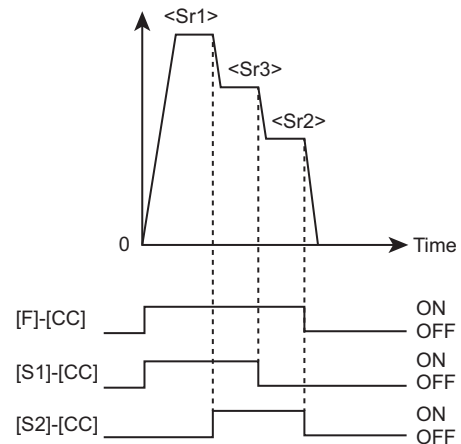

- 18 When you turn on relay 2 with relay 1 on, the frequency command value of <Sr3> is enabled, and the output frequency changes.

The output frequency changes to the frequency command value set with <Sr3: Preset speed 3> and becomes stable.

In the example on the right, it is 15.0 Hz.

- 19 When you turn off relay 1 with relay 2 on, the frequency command value of <Sr2> is enabled, and the output frequency changes.

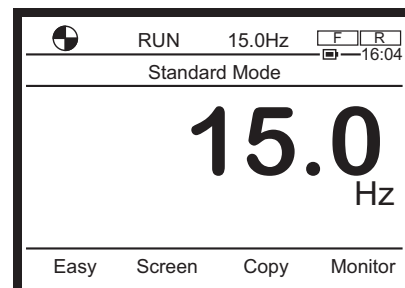

The output frequency changes to the frequency command value set with <Sr2: Preset speed 2> and becomes stable.

In the example on the right, it is 10.0 Hz.

- 20 When you turn off the external switch, the motor decelerates and stops.

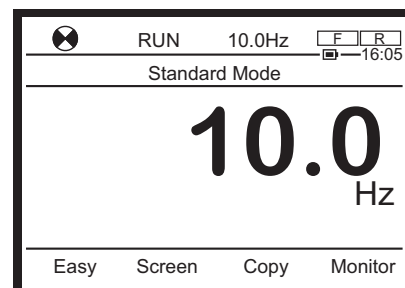

**Memo**

- For details of preset speed operation, refer to [5. 3. 7].

# 5 [Fundamental operation] How to use parameters

I

II

Frequently set parameters include default 10 parameters in [Easy mode] and basic parameters. This chapter describes these parameters.

1

2

3

4

5

6

7

8

9

10

11

12

13

14

15

16

## 5.1 Table of parameter access

## 5.2 Settings of main parameters

This section describes how to select run and frequency commands required for operating the motor, how to limit the output frequency, how to set acceleration/deceleration time, how to set the electronic thermal for motor protection, and how to adjust the meter.

### 5.2.1 Selecting how to input run and frequency commands

#### (1) Selecting how to input run/stop

<CMOd: Run command select>

Basic parameter

Easy mode

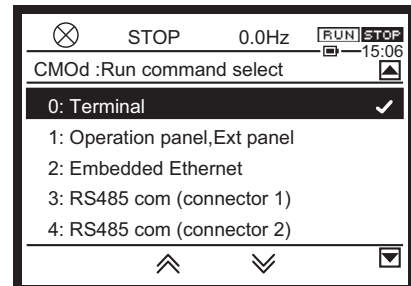

#### ■ Function

Select where to input a run command to the inverter.

#### ■ Parameter setting

Title	Parameter name	Adjustment range	Default setting
CMOd	Run command select	0: Terminal 1: Operation panel, Extension panel 2: Embedded Ethernet 3: RS485 communication (connector 1) 4: RS485 communication (connector 2) 5: Communication option	0

## ■ Selecting a setting value

### 0: Terminal

Run/stop the inverter with an external ON/OFF signal.

For how to set terminals and parameters to be used, refer to [4. 4].

For details of operation by external signals, refer to [Chapter 7].

### 1: Operation panel, Extension panel

Press the [RUN], [STOP] key on the operation panel to run/stop the inverter.

You can do it even on the optional extension panel.

For how to set this value, refer to [4. 3].

### 2: Embedded Ethernet

Connect a communication cable to the Ethernet connector 1 or 2, and run/stop the inverter through the Ethernet communication.

For details, refer to "Communication Function Instruction Manual" (E6582125).

## 5

### 3: RS485 communication (connector 1)

This has the operation panel mounted when shipped from the factory. Remove the operation panel and connect a communication cable, and you can run/stop the inverter through the RS485 communication.

For details, refer to E6582143.

### 4: RS485 communication (connector 2)

Connect a communication cable to the RS485 communication connector 2 next to the control terminal block. Then, you can run/stop the inverter through the RS485 communication.

For details, refer to [6. 38].

### 5: Communication option

Run/stop the inverter with a communication option command.

For details, refer to Each "Communication function instruction manual."

## Memo

- Assign the input terminal function "108: Terminal operation priority" to an unused input terminal. When the input terminal is ON, run command is terminal run. For details, refer to the table of input terminal functions in [7. 2. 1] or [11. 8].
- The priority command from the communication or terminal precedes the command set with <CMOd: Run command select>.



(2) Selecting how to input a frequency command

<FM0d: Frequency command select 1>

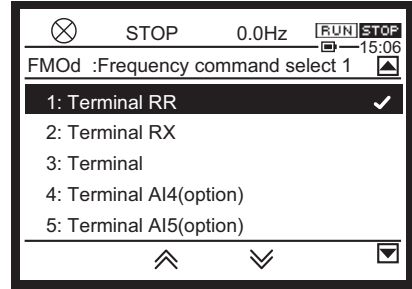

■ Function

Select where to input a frequency command to the inverter.

■ Parameter setting

Title	Parameter name	Adjustment range	Default setting
FM0d	Frequency command select 1	0: - 1: Terminal RR 2: Terminal RX 3: Terminal II 4: Terminal AI4 (option) 5: Terminal AI5 (option) 6 - 9: - 10: Touch wheel 1 (power off or press OK to save) 11: Touch wheel 2 (press OK to save) 12: Sr0 13, 14: - 15: Terminal Up/Down frequency 16: Pulse train 17: High resolution pulse train (option) 18, 19: - 20: Embedded Ethernet 21: RS485 communication (connector 1) 22: RS485 communication (connector 2) 23: Communication option	1

■ Selecting a setting value

1: Terminal RR

Analog signal: Input a frequency command with 0 - 10 Vdc.  
For details of the control terminal, refer to [2. 3. 5].  
For details of operation by external signals, refer to "Chapter 7".

2: Terminal RX

Analog signal: Input a frequency command with -10 to +10Vdc.  
For details of the control terminal, refer to [2. 3. 5].  
For details of operation by external signals, refer to "Chapter 7".

3: Terminal II

Analog signal: Input a frequency command with 4 - 20 mAdc (0 - 20 mAdc).  
For details of the control terminal, refer to [2. 3. 5].

For details of operation by external signals, refer to "Chapter 7".

#### 4: Terminal AI4 (option)

The terminal [AI4] is included in the cassette option. Input a frequency command with an analog signal.

For details of the optional terminal [AI4], refer to [10. 4. 1].

#### 5: Terminal AI5 (option)

The terminal [AI5] is included in the cassette option. Input a frequency command with an analog signal.

For details of the optional terminal [AI5], refer to [10. 4. 1].

#### 10: Touch wheel 1 (power off or press OK to save)

Use the touch wheel on the operation panel to input a frequency command.

Even if you turn off the power supply without pressing the [OK] key, a frequency command value will be saved.

On the extension panel, use the up and down arrow keys to input a frequency command.

Even if you turn off the power supply without pressing the [ENT] key, a frequency command value will be saved.

For how to set this value, refer to [4. 3. 1] and [4. 4. 1].

#### 11: Touch wheel 2 (press OK to save)

Use the touch wheel on the operation panel to input a frequency command.

Press the [OK] key, and a frequency command value will be saved.

On the extension panel, use the up and down arrow keys to input a frequency command.

Press the [ENT] key, a frequency command value will be saved.

For how to set this value, refer to [4. 3. 1] and [4. 4. 1].

#### 12: Sr0

Set the value of the parameter <Sr0: Preset speed 0> as a setting value of a frequency command.

For details of <Sr0: Preset speed 0>, refer to [5. 3. 7].

#### 15: Terminal Up/Down frequency

Input a frequency command with an Up/Down command to the input terminal.

For details of how to set parameters and terminals, refer to [6. 6. 5].

#### 16: Pulse train

Input a frequency command with a pulse train signal (up to 30 kpps) to the terminals [S4] and [S5].

For how to set this value, refer to [6. 6. 4].

#### 17: High resolution pulse train (option)

Input a frequency command with a high resolution pulse train signal to the input terminal.

For how to set this value, refer to "Digital Encoder Instruction Manual" (E6582148).

#### 20: Embedded Ethernet

Connect a communication cable to the Ethernet connector 1 or 2, and input a frequency command through the Ethernet communication.

For details, refer to "Ethernet Function Instruction Manual" (E6582125).

**21: RS485 communication (connector 1)**

Remove the operation panel, connect a communication cable, and input a frequency command through the RS485 communication.

For details, refer to [6. 38].

**22: RS485 communication (connector 2)**

Connect a communication cable to the RS485 communication connector 2 next to the control terminal block, and input a frequency command through the RS485 communication.

For details, refer to [6. 38].

**23: Communication option**

Input a frequency command with a communication option command.

For details, refer to Each "Communication function instruction manual."

**Memo**

- The following functions set for the input terminal are always enabled regardless of the settings of <CMOd: Run command select> and <FMOD: Frequency command select 1>.
  - Reset (enabled at trip only)
  - Standby
  - External thermal trip
  - Coast stop command
- Set <CMOd: Run command select> and <FMOD: Frequency command select 1> after stopping the inverter.  
You cannot set them during run.  
However, when <F736: CMOD/FMOD change lockout during run> is set to "0: Unlocked", you can change them during run. For details, refer to [6. 34. 1].
- The priority command from the communication or terminal precedes the setting of <FMOD: Frequency command selection 1>.
- <F207: Frequency command select 2> is provided.  
Use <FMOD: Frequency command select 1> in the default setting. However, you can switch between two frequency command selections. For details, refer to [5. 4. 1].

(3) Example of switching run and frequency commands

The figure below shows an example of switching run and frequency commands.

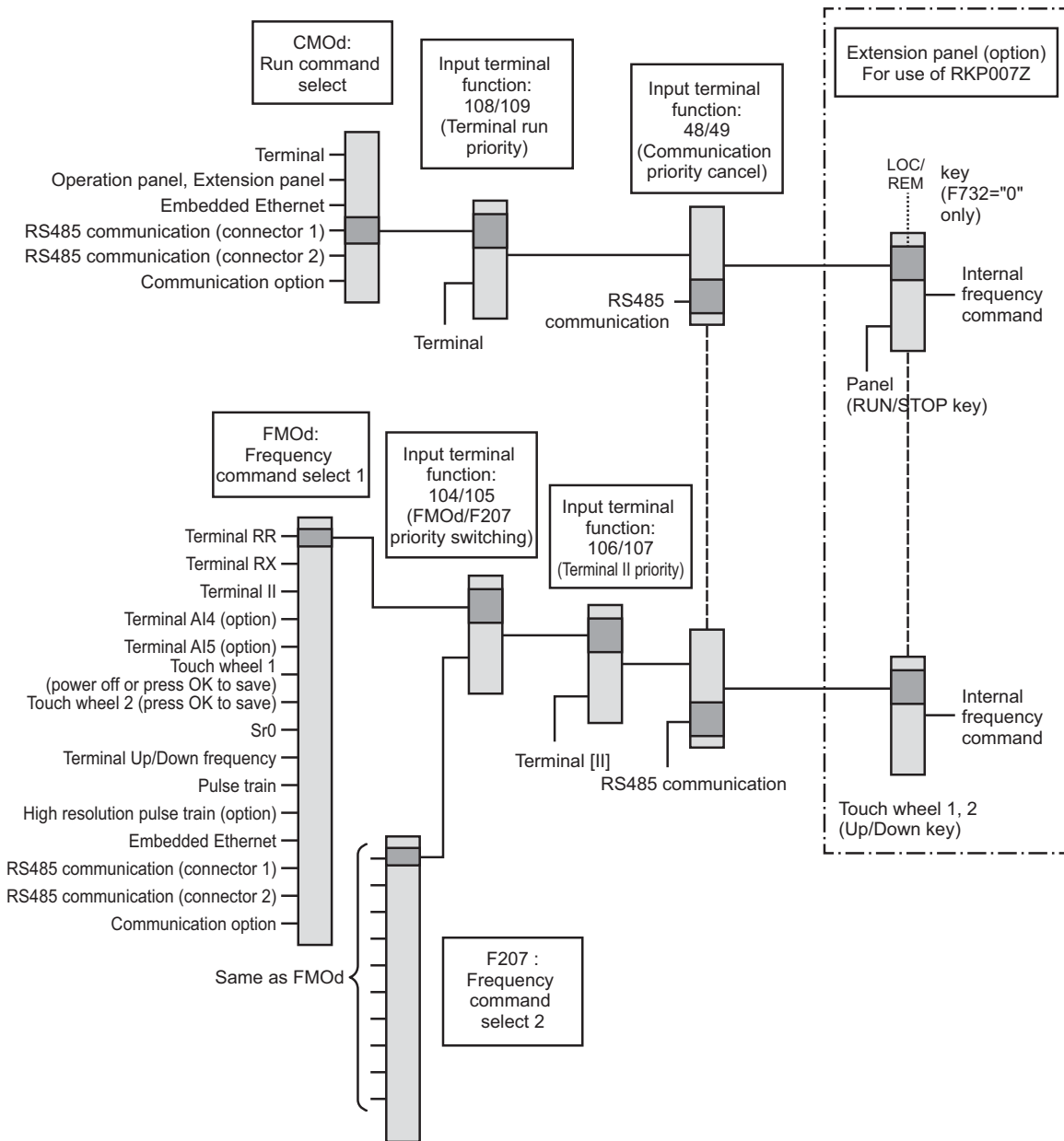

5

## 5. 2. 2 Setting rated frequency and rated voltage of motor

<vL: Base frequency 1>

Basic parameter

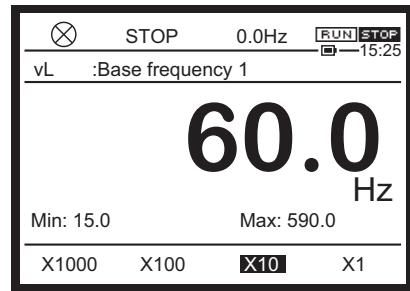

<vLv: Base frequency voltage 1>

Basic parameter

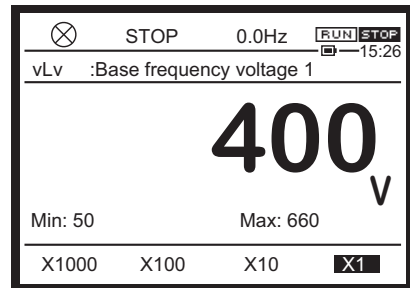

5

### ■ Function

These parameters are used to set the rated frequency and rated voltage of the motor according to machinery. They are important parameters to decide the control range of the inverter.

### ■ Parameter setting

Title	Parameter name	Adjustment range	Unit	Default setting
vL	Base frequency 1	15.0 - 590.0	Hz	50.0/60.0 *1
vLv	Base frequency voltage 1	240V class: 50-330 480V class: 50-660	V	*1

\*1 Depending on the setup menu. Refer to [5. 3. 10].  
The value of <vL> should be equal or smaller than that of <FH>.

### ■ Reference of setting

Set the rated frequency (50 Hz, 60 Hz, etc.) and rated voltage (200 V, 220 V, etc.) of the motor according to the specifications of machinery.

The inverter is controlled based on the rating of the motor specified with these parameters.

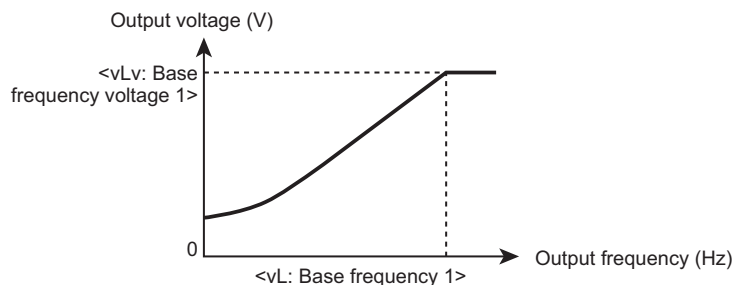

**Memo**

- You can set four types of motor rating. For details including <F170: Base frequency 2>, refer to [6. 4].

### 5. 2. 3 Setting the output frequency limit

#### (1) **Setting the maximum frequency of the inverter**

<FH: Maximum frequency>

Basic parameter

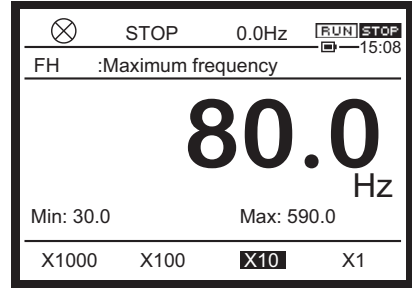

#### ■ **Function**

Set the maximum value of the frequency output from the inverter.  
This frequency is also the criteria of acceleration and deceleration time.

#### ■ **Parameter setting**

Title	Parameter name	Adjustment range	Unit	Default setting
FH	Maximum frequency	30.0 - 590.0	Hz	80.0 *1

\*1 Depending on the setup menu. Refer to [5. 3. 10].  
The value of <FH> should be equal or greater than that of <VL>.

#### ■ **Guideline for the setting**

Set the maximum frequency suited for the rating of the motor and load.

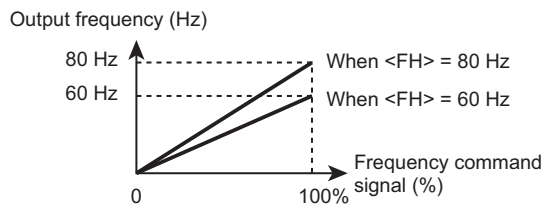

#### Memo

- Set <FH: Maximum frequency> after stopping the inverter. You cannot set it during run.
- When increasing the value of <FH: Maximum frequency>, you should also set the corresponding value of <UL: Upper limit frequency> as required. --> Refer to the following "Setting the upper and lower limits of the output frequency".

(2) Setting the upper and lower limits of the output frequency

<UL: Upper limit frequency>



<LL: Lower limit frequency>

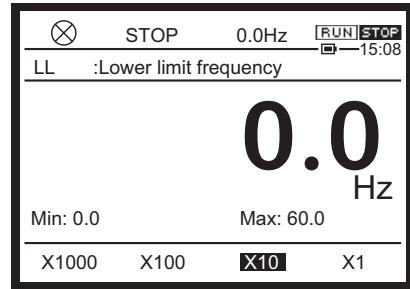
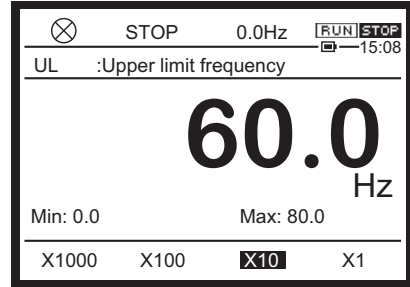

5

■ Function

Set the upper limit frequency to decide the upper limit of the output frequency and the lower limit frequency to decide the lower limit.

■ Parameter setting

Title	Parameter name	Adjustment range	Unit	Default setting
UL	Upper limit frequency	0.0 - FH	Hz	50.0/60.0 *1
LL	Lower limit frequency	0.0 - UL	Hz	0.0

\*1 Depending on the setup menu. Refer to [5. 3. 10].

■ Guideline for the setting

Set <UL: Upper limit frequency> to a value which is ten times or less the values of <vL: Base frequency 1>.

If the output frequency is exceeding to 10 times of <vL>, the "A-05" alarm will appear, and the value of the output frequency will be limited to a value which is 10 times the value of <vL: Base frequency 1>.

The same holds for Base frequency 2 - 4. (Refer to [6. 4].)



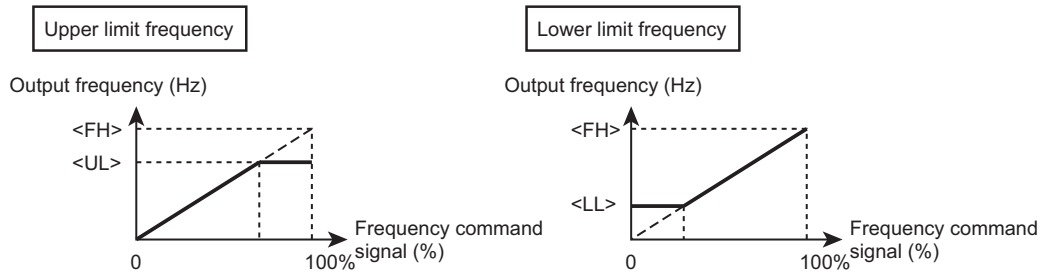

**Memo**

- Frequencies under the setting value of <F240: Start frequency> are not output. --> Refer to [6. 7. 1].
- During operation of the stall prevention, the inverter may run at the frequency exceeding the value of <UL: Upper limit frequency> or the frequency under the value of <LL: Lower limit frequency>.

## 5. 2. 4 Setting acceleration/deceleration time

<ACC: Acceleration time 1>



<dEC: Deceleration time 1>

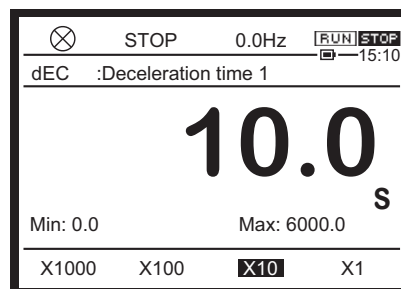
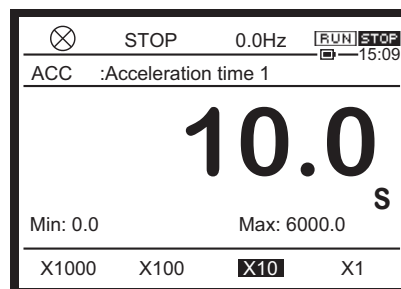

5

### ■ Function

Set a time for acceleration and deceleration.

In <ACC: Acceleration time 1>, set a time before the output frequency of the inverter reaches the value of <FH: Maximum frequency> from 0.0 Hz.

In <dEC: Deceleration time 1>, set a time before the output frequency of the inverter decreases to 0.0 Hz from the value of <FH: Maximum frequency>.

Unit for a setting time is selected with <F519: Unit of Acc/Dec time>.

### ■ Parameter setting

Title	Parameter name	Adjustment range	Unit	Default setting
ACC	Acceleration time 1	0.0 - 6000 (600.0)	s	*1
dEC	Deceleration time 1	0.0 - 6000 (600.0)	s	*1

\*1 The default is 10.0/30.0/60.0 (s) depending on the capacity. Refer to [11. 6].

Title	Parameter name	Adjustment range	Default setting
F519	Unit of Acc/Dec time	0: - 1: 0.01s unit (0 after execution) 2: 0.1s unit (0 after execution)	0

■ **Guideline for the setting**

The criteria of acceleration time and deceleration time is the value of <FH: Maximum frequency>. Note that it is not the value of <UL: Upper limit frequency>.

You can use <F519: Unit of Acc/Dec time> to switch the unit of setting time between 0.1s and 0.01s. With acceleration/deceleration time set to 0.0 second, the unit of 0.05 second is used internally for <F519> is "2: 0.1s unit" (default setting), and the unit of 0.01 second for <F519> is "1: 0.01s unit".

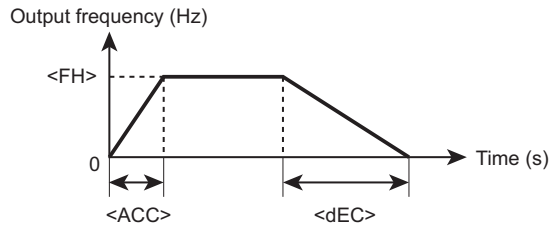

**Memo**

- When you set a time shorter than the optimum acceleration/deceleration time determined by the load condition, the stall prevention action may cause the acceleration/deceleration time to be longer than the setting value.
- If you set a further shorter acceleration/deceleration time, the inverter may stop due to an overcurrent trip or overvoltage trip for protection. For details, refer to "Chapter 13".
- The stop methods of the motor are the deceleration stop by <dEC: Deceleration time 1> or the coast stop. For details, refer to [6. 3. 1].
- You can set four types of options for each acceleration and deceleration time. For Acceleration time 2 through 4 and Deceleration time 2 through 4, refer to [6. 27. 2].

## 5. 2. 5 Protecting the motor from overload

<tHrA: Motor overload protection current 1>

Basic parameter

Easy mode

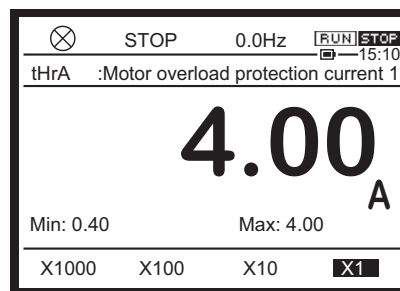

### ■ Function

Set a protection characteristic of the electronic thermal suited for the rating and characteristic of the motor. The electronic thermal operates based on the set current value, and any trip occurs. This will protect the motor.

### ■ Parameter setting

Title	Parameter name	Adjustment range	Unit	Default setting
tHrA	Motor overload protection current 1	Depending on capacity *1	A *1	*1

\*1 The range, unit, and default setting are depending on the capacity. Refer to [11. 6].

### ■ Reference of setting

Set <tHrA> suited for the motor rated current. Set necessary parameters for the used motor or operation.

### ■ Selecting a motor type and protective function: <OLM: Motor overload protection characteristic>, <F606: Motor overload reduction frequency threshold>

Select a motor type and whether the motor overload trip "OL2" and overload stall are enabled or disabled.

The inverter overload trip "OL1" is always detected to protect the inverter.

Title	Parameter name	Adjustment range	Unit	Default setting
OLM	Motor overload protection characteristic	0: Standard motor, OL2, No stall 1: Standard motor, OL2, Stall 2: Standard motor, No OL2 trip, No stall 3: Standard motor, No OL2 trip, Stall 4: Constant torque motor, OL2, No stall 5: Constant torque motor, OL2, Stall 6: Constant torque motor, No OL2 trip, No stall 7: Constant torque motor, No OL2 trip, Stall		0
F606	Motor overload reduction frequency threshold	0.0 - 60.0	Hz	6.0

Memo

**What is overload stall?**

- The overload stall function can apply to variable torque characteristic load where a lower frequency reduces load current, such as a fan, pump, and blower.  
When the inverter detects overload, this function automatically lowers the output frequency before the motor overload trip "OL2" occurs. This function enables you to run the inverter at the frequency where load current balances. As a result, the inverter can continue to run without trip.
- Do not apply the overload stall function to constant torque characteristic load (load with constant load current regardless of the frequency, for example, in a conveyor).

**1) When the general purpose motor is used**

When the motor runs at low speed (low frequency), its cooling effect will degrade. To prevent overheat of the motor caused by this problem, the inverter starts to detect overload earlier than usual when using the general purpose motor.

**<OLM: Motor overload protection characteristic> = "0" to "3"**

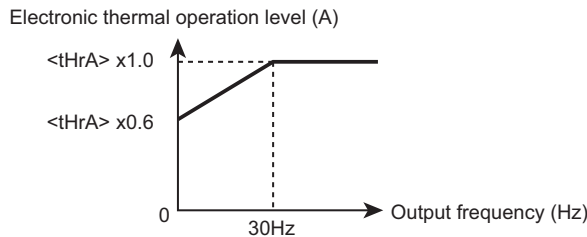

The reduction start frequency of the electronic thermal is fixed to 30 Hz.

**2) When the constant-torque motor is used**

The constant-torque motor can run at constant torque at lower speed (lower frequency) compared to the general purpose motor. However, an extremely low speed will cause the cooling effect of the motor to decrease.

Set the value of <F606: Motor overload reduction frequency threshold> suited for the motor characteristic.

**<OLM: Motor overload protection characteristic> = "4" to "7"**

**Setting of <F606: Motor overload reduction frequency threshold>**

We recommend the estimation of across 6 Hz (default setting) (refer to the following figure).

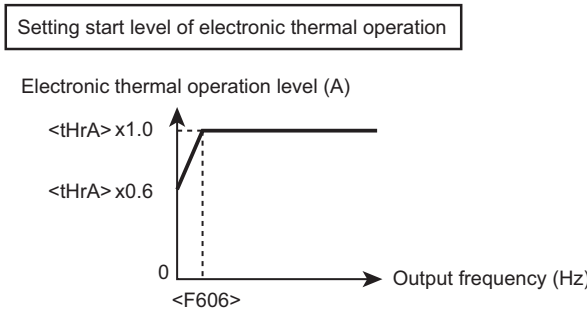

■ **Setting a time before the trip of the electronic thermal occurs: <F607: Motor overload time>**

Setting a time before the trip of the electronic thermal occurs: <F607: Motor overload time>

Set a time before the overload trip "OL2" occurs at the motor overload of 150%.

Title	Parameter name	Adjustment range	Unit	Default setting
F607	Motor overload time	10 - 2400	s	300

5

Monitored output current (%)		Motor overload time (s) (Outline data)			
tHrA=100	tHrA=50	F607=600 is set		F607=300 is set	
		F606 or more	0.01 Hz	F606 or more	0.01 Hz
68	34	-	7200	-	3600
70	35	-	3600	-	1800
80	40	-	1000	-	500
90	45	-	600	-	300
100	50	-	420	-	210
112	56	12000	310	6000	155
120	60	2400	270	1200	135
130	65	1200	230	600	115
140	70	800	190	400	95
150	75	600	170	300	85
200	100	270	110	135	55

Motor overload protection characteristics

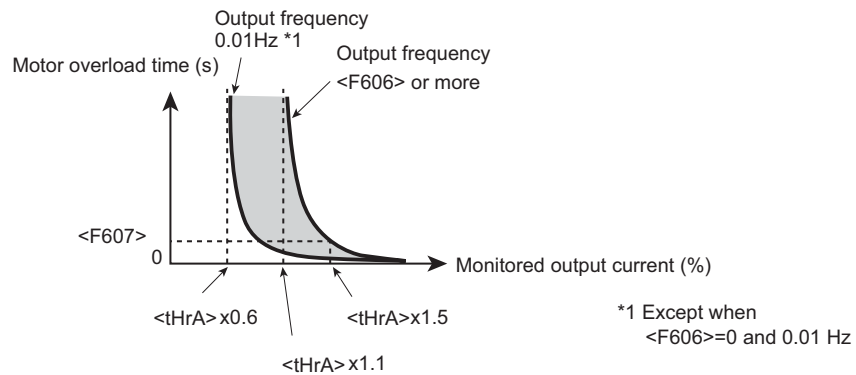

■ **Selecting how to detect inverter overload: <F631: Inverter overload detection>**

This function enables to automatically increase the continuous output current and the inverter overload capacity when the ambient temperature is low.

Title	Parameter name	Adjustment range	Default setting
F631	Inverter overload detection	HD 0: 150%-60s 1: Temperature estimation ND 0: 120%-60s 1: Temperature estimation	10

Set <F631: Inverter overload detection> to "1: Temperature estimation".

- If the inverter overload trip "OL1" occurs, you can clear it by decreasing the value of <F601: Stall prevention level 1> or setting <ACC: Acceleration time 1> or <dEC: Deceleration time 1> to a longer value.
- To protect the inverter unit, you cannot turn off inverter overload detection.

**0: 150%-60s (HD rating) or 0: 120%-60s (ND rating)**

The inverter is protected with the uniform overload curve of 150%-60s (120%-60s for ND rating), regardless of temperature.

Inverter overload protection characteristics

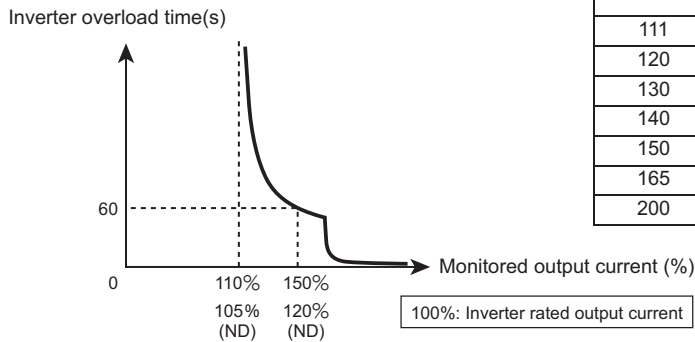

**1: Temperature estimation**

Estimate inverter internal temperature rise and automatically adjust overload protection characteristics (the diagonally shaded area in the following figure).

Inverter overload protection characteristics

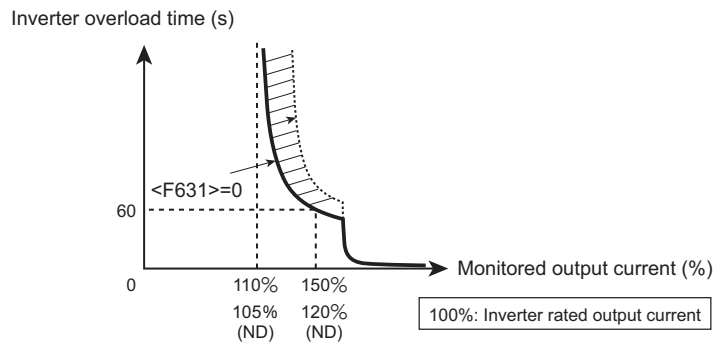

- When the output frequency is 0.1 Hz or less, or when the output current is 150% or more, the overload trip "OL1" or overcurrent trips "OC1 through OC3" may occur in shorter time to protect the inverter.

- The overload detection level depends on the output frequency or carrier frequency.

### ■ Saving an overload integral value at power off : <F632: Electronic thermal memory target>

Set a target to reset the integral value of overload at power off. It applies to both the motor electronic thermal and overload detection for inverter protection.

Title	Parameter name	Adjustment range	Default setting
F632	Electronic thermal memory target	0: No.1 to 4 motor, memory disabled 1: No.1 to 4 motor, memory enabled 2: No.1 motor, memory disabled 3: No.1 motor, memory enabled	0

**0: No.1 to 4 motor, memory disabled**

**2: No.1 motor, memory disabled**

Reset the integral value. "0" applies to No.1 to 4 motors and "2" to the No.1 motor only.

**1: No.1 to 4 motor, memory enabled**

**3: No.1 motor, memory enabled**

For memory enabled, the overload integral values of the motor and inverter are saved at power off. When power supply is ON again, the calculation process is resumed from the state when it is powered off.

However, with the RTC enabled (with operation panel), the subtraction process is performed according to virtual cooling curves, regardless of the setting.

### ■ Overload pre-alarm output

When the motor overload level reaches the setting value (%) of <F657: Overload alarm level> for the overload trip "OL2" integral value, "L" appears. Also, an overload pre-alarm signal can be output from the output terminal. For details, refer to [7. 2. 2].

Title	Parameter name	Adjustment range	Unit	Default setting
F657	Overload alarm level	10 - 100	%	50



## 5. 2. 6 Adjusting the meter connected to the inverter

<FM: Terminal FM adjustment>



<FM: Terminal FM adjustment>

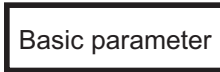

<F671: Terminal AM adjustment>

<F670: Terminal AM function>

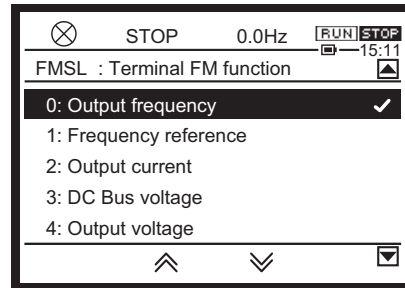
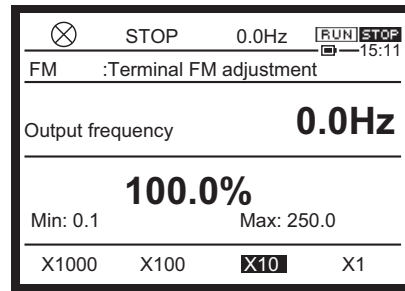

5

### ■ Function

To indicate the output frequency and output current of the inverter in the meter, connect the meter to the terminal [FM] or [AM].

After connecting them, you should adjust the scale of the meter.

### ■ Parameter setting

Title	Parameter name	Adjustment range	Unit	Default setting
FM	Terminal FM adjustment	0.1 - 250.0	%	100.0
F671	Terminal AM adjustment	0.1 - 250.0	%	100.0

Select the content to be indicated in the meter by <FMSL: Terminal FM function> and <F670: Terminal AM function>.

Title	Parameter name	Adjustment range	Default setting
FMSL	Terminal FM function	0: Output frequency 1: Frequency command value 2: Output current 3: Input voltage (DC detection) 4: Output voltage 5: Stator frequency 6: Speed feedback frequency (real time) 7: Speed feedback frequency (1-second filter) 8: Torque 9: Torque command	0

Title	Parameter name	Adjustment range	Default setting
		10: Output frequency during run. Frequency command value during stop. 11: Torque current 12: Exciting current 13: PID feedback value 14: Motor overload factor (OL2 data) 15: Inverter overload factor (OL1 data) 16: Braking resistor overload factor (OLr data) 17: Braking resistor load factor (%ED) 18: Input power 19: Output power 20: Input cumulative power 21: Output cumulative power 22: Fixed output 1 23: Fixed output 2 24: Terminal RR input value 25: Terminal RX input value 26: Terminal II input value 27: Motor speed command 28: Terminal FM output value 29: Terminal AM output value 30: - 31: Communication data output 32 - 33: - 34: Motor load factor 35: Inverter load factor 36 - 40: - 41: Terminal FP pulse train output value 42: - 43: - 44: Terminal AI4 input value 45: Terminal AI5 input value 46 - 49: My function monitor output 1 - 4 50 - 61: - 62: PID result frequency 63: PID set value 64: Light-load high-speed switching load torque 65: Light-load high-speed torque during constant speed run 66 - 70: - 71: Motor speed (estimated value) 72 - 75: - 76: Terminal S4/S5 pulse train input value 77 - 78: - 79: Dancer control PID result frequency 80 - 119: - 120: Internal temperature 1 121 - 123: - 124: Power circuit board temperature 125 - 129: -	

Title	Parameter name	Adjustment range	Default setting
		130: External PID3 set value 131: External PID3 feedback value 132: External PID3 result value 133: External PID4 set value 134: External PID4 feedback value 135: External PID4 result value 136 - 149: - 150: Signed output frequency 151: Signed frequency command value 152: Signed stator frequency 153: Signed speed feedback frequency (real time) 154: Signed speed feedback frequency (1-second filter) 155: Signed torque 156: Signed torque command 157: - 158: Signed torque current 159: Signed PID feedback value 160: Signed terminal RX input value 161: Signed terminal AI4 input value 162: Signed terminal AI5 input value	
F670	Terminal AM function	Same as <FMSL>	2

■ How to adjust the scale of the meter with the inverter run

As an example, this section describes how to adjust the scale of the frequency meter connected to the terminal [FM].

Use the adjustment screw of the meter to set a zero point in advance.

This method can apply to the meter connected to the terminal [AM] as well.

- 1 Connect the frequency meter as shown in the figure below.

For how to connect it to the control terminal block, refer to [2. 3. 5] and [4. 4].

Instruction of output frequency

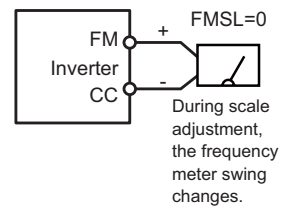

- In the basic parameters of [Setting mode], set <FMSL: Terminal FM function> to "0: Output frequency".

The default setting of <FMSL> is "0".

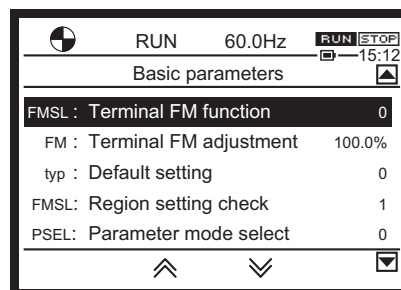

- In the basic parameters of [Setting mode], select <FM: Terminal FM adjustment> and press the [OK] key.

The output frequency of the inverter is displayed in the upper part of the screen, and the output level (%) of the terminal [FM] in the lower part.

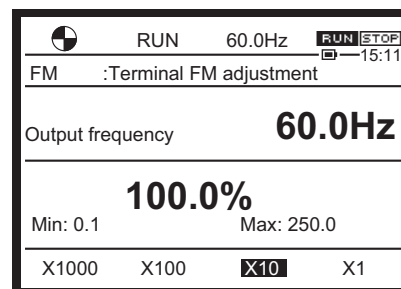

5

- Turning the touch wheel will change the indication of the meter and the output level (%) of the terminal [FM] in the lower field of the screen. Adjust the scale so that the indication of the meter matches the output frequency.



- Press the [OK] key to complete the adjustment of the meter.

■ How to adjust the scale of the meter with the inverter stopped

You can adjust the scale of the meter even at the inverter stop state.

When <FMSL: Terminal FM adjustment> and <F670: Terminal AM adjustment> are set "22", signal value is fixed at the following values.

<FMSL>/<F670>

- 0, 1, 5, 6, 7, 10, 13, 62, 63, 79, 130, 131, 132, 133, 134, 135, 150, 151, 152, 153, 154, 159 : Maximum frequency (FH)
- 2, 11, 12, 108 : 200% of rated current
- 3, 4 : 150% of rated voltage
- 8, 9, 64, 65, 155, 156 : 250% of rated torque
- 14, 15, 16 : Maximum value of OL factor (100%)
- 34 : Maximum value of OL2 factor (600%)
- 35 : Maximum value of OL1 factor (250%)
- 17 : %ED value of braking resistor

- 18, 19 : 200% of rated power
- 20, 21 : 1000 x F749
- 24, 25, 26, 28, 29, 31, 41, 44, 45, 74, 75, 76, 160, 161, 162 : Maximum value
- 27, 71 : FH x 60/F856
- 46, 47 : 65535
- 48, 49 : 32767
- 120, 124 : 200°C

When <FMSL: Terminal FM adjustment> and <F670: Terminal AM adjustment> are set "23", signal value is fixed at half of the above values.

■ For 4 - 20 mA output

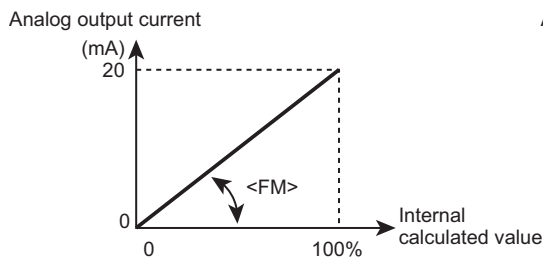

This is when <F682: Terminal FM inclination polarity> is "1: Positive inclination (upward slope)" and <F683: Terminal FM bias> is "0". When <F682> is set to "0: Negative inclination (downward slope)", the inclination becomes negative.

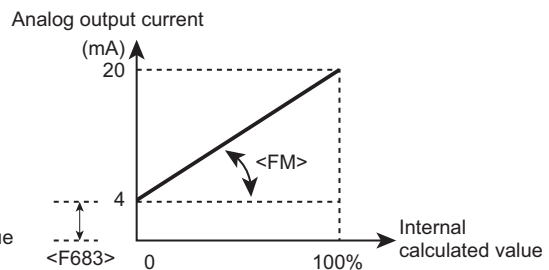

This is when <F682> is "1" and <F683: Terminal FM bias> is "20". 20% value (4mA) of the full scale output current (20 mA in this case) will be the output current at internal calculated value of 0%.

Adjust the values of <F682: Terminal FM inclination polarity> and <F683: Terminal FM bias> for 4 - 20 mA output.

For details, refer to [6. 33. 3].

Memo

- The maximum resolution is 1/1024 for both the terminals [FM] and [AM].
- To use the terminals [FM] and [AM] for current output, set external load resistance to 600Ω or less.
- To use the terminals [FM] and [AM] for voltage output, set external load resistance to 1kΩ or more.

### 5. 2. 7 Selecting the display units for current and voltage

<F701: Current, voltage units select>

Easy mode

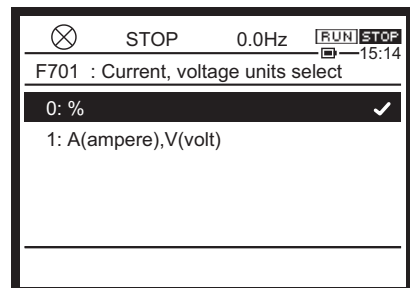

■ **Function**

Select the display units of parameters and monitors represented in current and voltage.

■ **Parameter setting**

Title	Parameter name	Adjustment range	Default setting
F701	Current, voltage units select	0: % 1: A (ampere), V (volt)	0

■ **Applicable parameters and monitors**

The following list shows parameters and monitors whose display units can be changed with <F701: Current, voltage units select>.

**Displayed in A (amperes)**

- Parameter
  - <F251: DC braking current>
  - <F601: Stall prevention level 1>, <F185: Stall prevention level 2>
  - <F326: Brake release undercurrent threshold>
  - <F611: Undercurrent detection level>
- Monitor
  - Output current
  - Torque current
  - Exciting current

**Displayed in V (volts)**

- Parameter
  - <F191: V/f 5-point VF1 voltage>
  - <F193: V/f 5-point VF2 voltage>
  - <F195: V/f 5-point VF3 voltage>
  - <F197: V/f 5-point VF4 voltage>
  - <F199: V/f 5-point VF5 voltage>
- Monitor
  - Input voltage
  - Output voltage

<vLv: Base frequency voltage 1>, <F171: Base frequency voltage 2>, <F175: Base frequency voltage 3>, and <F179: Base frequency voltage 4> are always displayed in V (volts). You cannot change it.

■ **Selecting a setting value**

**0: %**

Current and voltage are displayed in percent.

For current (A), 100% means the rated current of the inverter.



For voltage (V), 100% with 200 V for 240 V class and 400 V for 480 V class.



**1: A (ampere), V (volt)**

Current is displayed in A (amperes) and voltage in V (volts).

■ **Setting example**

While a model with a rated current of ●● A is used at the rated load (100% load), the monitor mode is displayed as follows:

 RUN 60.0Hz  15:15 Monitor Mode	
Direction of rotation	Forward
Output current	0%
DC bus voltage	119%
Output voltage	0%
Torque	0%
Top	Easy Setting

 RUN 60.0Hz  15:15 Monitor Mode	
Direction of rotation	Forward
Output current	0.0A
DC bus voltage	476V
Output voltage	0V
Torque	0%
Top	Easy Setting

## 5. 2. 8 Selecting the parameter mode between [Setting mode] and [Easy mode]

<PSEL: Parameter mode select>

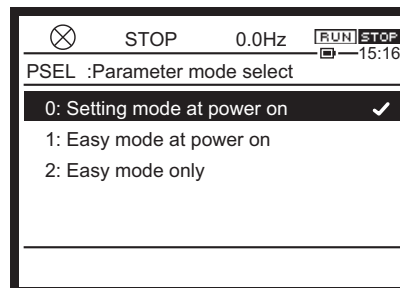

### ■ Function

Select the display mode of parameter settings between [Setting mode] and [Easy mode]. You can select a mode at power on and use the operation key to switch it or see only [Easy mode]. How to read parameters depends on a mode.

#### [Easy mode]

- Register frequently set parameters as [Easy mode] parameters in advance. Only the registered parameters (up to 32) appear.
- Ten parameters are selected in the default setting. You can change them as required.

#### [Setting mode]

- You can read all parameters in the standard [Setting mode].

### ■ Parameter setting

Title	Parameter name	Adjustment range	Default setting
PSEL	Parameter mode select	0: Setting mode at power on 1: Easy mode at power on 2: Easy mode only	0

### ■ Selecting a setting value

#### 0: Setting mode at power on

The parameter mode is set to [Setting mode] at power on. You can use the operation key to switch between [Setting mode] and [Easy mode].

- Operation panel: [ESC] key or [F1] key  
For details, refer to [3. 1. 2].
- Extension panel: [EASY] key (if any)

#### 1: Easy mode at power on

The parameter mode is set to [Easy mode] at power on. You can use the operation key to switch between [Setting mode] and [Easy mode].

- Operation panel: [ESC] key or [F1] key  
For details, refer to [3. 1. 2].
- Extension panel: [EASY] key (if any)

#### 2: Easy mode only

The parameter mode is always [Easy mode]. You cannot see the [Setting mode] screen.

5



■ **Setting parameters in [Easy mode]**

Up to 32 parameters are displayed in [Easy mode]. Set among <F751: Easy setting 1> through <F782: Easy setting 32>.

Title	Parameter name	Adjustment range	Default setting
F751	Easy setting 1	0 - 2999	3<CMOd>
F752	Easy setting 2	0 - 2999	4<FMd>
F753	Easy setting 3	0 - 2999	9<ACC>
F754	Easy setting 4	0 - 2999	10<dEC>
F755	Easy setting 5	0 - 2999	12<UL>
F756	Easy setting 6	0 - 2999	13<LL>
F757	Easy setting 7	0 - 2999	31<tHrA>
F758	Easy setting 8	0 - 2999	6<FM>
F759 - F780	Easy setting 9 through Easy setting 30	0 - 2999	999 (No function)
F781	Easy setting 31	0 - 2999	701<F701>
F782	Easy setting 32	0 - 2999	50<PSEL>

5

In [Easy mode], only parameters registered with <F751: Easy setting 1> through <F782: Easy setting 32> appear in the order of registration.

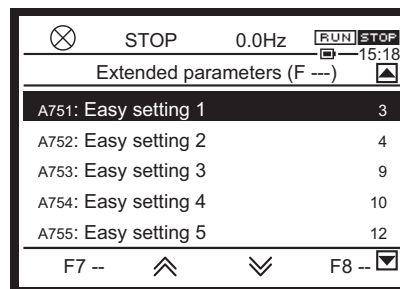

Set communication numbers of registered parameters for <F751: Easy setting 1> through <F782: Easy setting 32>.

For communication numbers, refer to [11. 2] - [11. 5].

Set the parameter address you want to display to F751-F782.

For example,

- in case the parameter F123 is set to F751, set 123 to F751.
- in case the parameter A456 is set to F752, set 1456 to F752.
- in case the parameter C789 is set to F753, set 2789 to F753.

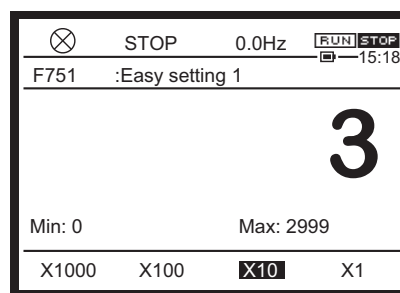

**Memo**

- When no parameter should be registered, set <F751: Easy setting 1> through <F782: Easy setting 32> to "999".

## 5. 2. 9 Returning parameters to their default settings Clearing each history

<tyP: Default setting>

Basic parameter

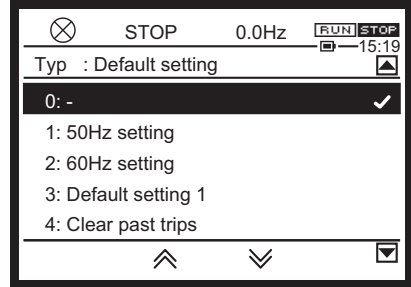

### ■ Function

You can return parameters to their default settings at a time, clear run times, and store/rewrite parameters specified by users.

5

### ■ Parameter setting

Title	Parameter name	Adjustment range	Default setting
tyP	Default setting	0: - 1: 50Hz setting 2: 60Hz setting 3: Default setting 1 4: Clear past trips 5: Clear cumulative run time 6: Initialize typeform 7: Store user settings 8: Rewrite user settings 9: Clear cumulative fan run time 10, 11: - 12: Clear number of starting 13: Default setting 2 (complete initialization) 14: Clear number of external equipment starting 15: Clear cumulative overcurrent time	0

Note) The setting value becomes 0 after execution, but a check mark is added to the previous setting value.

■ **Selecting a setting value**

**1: 50Hz setting**

The following parameters are set for the base frequency 50 Hz.

Setting values of other parameters are not changed.

When you select a parameter and press the [OK] key, nothing appears momentarily, the same content displayed at power on appears, and the mode enters [Standard mode].

<FH: Maximum frequency>	50Hz
<UL: Upper limit frequency>	*1 % display
<vL: Base frequency 1>	
<F170: Base frequency 2>	
<F174: Base frequency 3>	
<F178: Base frequency 4>	
<F204: RR point 2 frequency>	
<F213: RX point 2 frequency>	
<F219: II point 2 frequency>	
<F225: AI4 point 2 frequency>	
<F231: AI5 point 2 frequency>	
<F237: S4/S5 Pulse train input point 2 frequency>	
<F330: Light-load high-speed automatic operation frequency>	
<F355: Commercial power switching>	
<F364: PID1 deviation upper-limit>	
<F365: PID1 deviation lower-limit>	
<F367: PID1 set value upper-limit>	
<F370: PID1 output upper-limit>	
<F426: Fwd speed limit level>	
<F428: Rev speed limit level>	
<F814: Communication point 2 frequency>	
<A220: Pump increase detection frequency>	
<A229: Pump decrease switching frequency>	
<A230: PID start frequency at pump decrease switching>	
<A316: PID2 deviation upper-limit>	
<A317: PID2 deviation lower-limit>	
<A319: PID2 set value upper-limit>	
<A322: PID2 output upper-limit>	
<A538: PTI position frequency UL>	
<F417: Motor rated speed>	1400 - 1480min <sup>-1</sup> (Depending on capacity)

**2: 60Hz setting**

The following parameters are set for the base frequency 60Hz.

Setting values of other parameters are not changed.

When you select a parameter and press the [OK] key, nothing appears momentarily, the same content displayed at power on appears, and the mode enters [Standard mode].

5

<FH: Maximum frequency>	60Hz
<UL: Upper limit frequency>	*1 % display
<vL: Base frequency 1>	
<F170: Base frequency 2>	
<F174: Base frequency 3>	
<F178: Base frequency 4>	
<F204: RR point 2 frequency>	
<F213: RX point 2 frequency>	
<F219: II point 2 frequency>	
<F225: AI4 point 2 frequency>	
<F231: AI5 point 2 frequency>	
<F237: S4/S5 Pulse train input point 2 frequency>	
<F330: Light-load high-speed automatic operation frequency>	
<F355: Commercial power switching>	
<F364: PID1 deviation upper-limit>	
<F365: PID1 deviation lower-limit>	
<F367: PID1 set value upper-limit>	
<F370: PID1 output upper-limit>	
<F426: Fwd speed limit level>	
<F428: Rev speed limit level>	
<F814: Communication point 2 frequency>	
<A220: Pump increase detection frequency>	
<A229: Pump decrease switching frequency>	
<A230: PID start frequency at pump decrease switching>	
<A316: PID2 deviation upper-limit>	
<A317: PID2 deviation lower-limit>	
<A319: PID2 set value upper-limit>	
<A322: PID2 output upper-limit>	
<A538: PTI position frequency UL>	
<F417: Motor rated speed>	1680 - 1775min <sup>-1</sup> (Depending on capacity)

### 3: Default setting 1

Return parameters except for some ones to their default settings.

When you select the setting and press the [OK] key, "Init" blinks in the main area and "Initializing" appears under it for a while.

They disappear momentarily, the same content displayed at power on appears, and the mode enters [Standard mode].

The history of past trip data is cleared.

To initialize all parameters, set <tyP: Default setting> to "13".

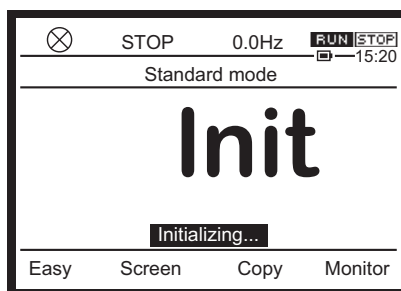

## Memo

- The values of the following parameters are designed not to return to their default settings, considering maintainability.  
Also, these parameters do not appear in the <Changed parameters search & edit> even if they are set to values different from default settings.
  - <FMSL: Terminal FM function>
  - <FM: Terminal FM adjustment>
  - <SEt: Region setting check>
  - <F107: Terminal RX input voltage select>
  - <F108: Terminal RR input select>
  - <F148: Terminal AI4 input select>
  - <F149: Terminal AI5 input select>
  - <F379: PG option voltage>
  - <F470: RR input bias>
  - <F471: RR input gain>
  - <F472: RX input bias>
  - <F473: RX input gain>
  - to
  - <F479: AI5 input gain>
  - <F669: Terminal FP switching>
  - <F670: Terminal AM function>
  - <F671: Terminal AM adjustment>
  - <F681: Terminal FM switching>
  - <F682: Terminal FM inclination polarity>
  - <F683: Terminal FM bias>
  - <F685: Terminal FM upper-limit level>
  - <F686: Terminal AM switching>
  - <F687: Terminal AM inclination polarity>
  - <F688: Terminal AM bias>
  - <F690: Terminal AM upper-limit level>
  - <F750: EASY key function>
  - <F790: Panel display at power on>
  - <F791: 1st and 2nd characters of F790> - <F798: 15th and 16th characters of F790>
  - <F809: Operation panel connection priority>
  - <F880: Free memorandum>
  - <A005 - A008: >
  - <C081 - C096: >

**4: Clear past trips**

Initialize (clear) the history information of eight past trips.

No parameter is changed.

When you select the setting and press the [OK] key, nothing appears momentarily, the same content displayed at power on appears, and the mode enters [Standard mode].

**5: Clear cumulative run time**

Clear cumulative run time to 0.

When you select the setting and press the [OK] key, nothing appears momentarily, the same content displayed at power on appears, and the mode enters [Standard mode].

**6: Initialize typeform**

Clear a trip if the type error "EtyP" occurs.

However, if it occurs, contact your Toshiba distributor.

When you select the setting and press the [OK] key, nothing appears momentarily, the same content displayed at power on appears, and the mode enters [Standard mode].

### 7: Store user settings

Store the setting values of all current parameters.

### 8: Rewrite user settings

Rewrite the setting values of the parameters stored in "7: Store user settings" to the inverter.

You can use parameter initial settings specific for users with "7: Store user settings" and "8: Rewrite user settings."

### 9: Clear cumulative fan run time

Clear cumulative fan run time to 0.

Set it, for example, when you have replaced the cooling fan.

When you select the setting and press the [OK] key, nothing appears momentarily, the same content displayed at power on appears, and the mode enters [Standard mode].

### 12: Clear number of starting

Clear the values on the monitor to 0 for the number of starting, the number of forward starting, and the number of reverse starting.

When you select the setting and press the [OK] key, nothing appears momentarily, the same content displayed at power on appears, and the mode enters [Standard mode].

### 13: Default setting 2 (complete initialization)

Return all parameters to their default settings at a time.

When you select the setting and press the [OK] key, "Init" blinks in the main area and "Initializing" appears under it for a while.

They disappear momentarily, the same content displayed at power on appears, and the mode enters [Standard mode].

All parameters are returned to their default settings, and the history data of past trips is also cleared.

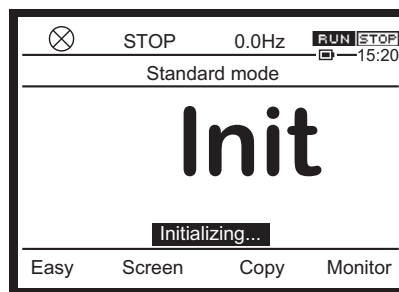

#### Memo

- Set <tyP: Default setting> after stopping the inverter. You cannot set it during run.

## 5.3 Setting other basic parameters

This section describes basic parameters not included in [5.2].  
Set any parameter in the [Setting mode].

### 5.3.1 Setting energy savings

<AUE: Eco-standby power setting>

Basic parameter

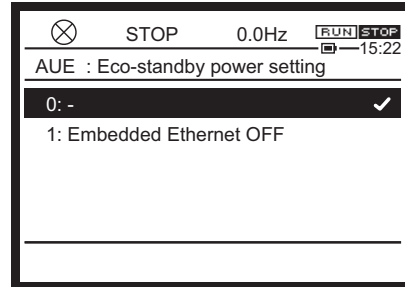

5

■ **Function**

Turn off the unused function to reduce standby electricity.

■ **Parameter setting**

Title	Parameter name	Adjustment range	Default setting
AUE	Eco-standby power setting	0: - 1: Embedded Ethernet OFF	0

Note) The setting value becomes 0 after execution, but a check mark is added to the previous setting value.

■ **Selecting a setting value**

**1: Embedded Ethernet OFF**

Standby electricity can be reduced when you do not use the embedded Ethernet.



### 5. 3. 2 Selecting an overload protection characteristic

<AUL: Multi-rating select>

Basic parameter

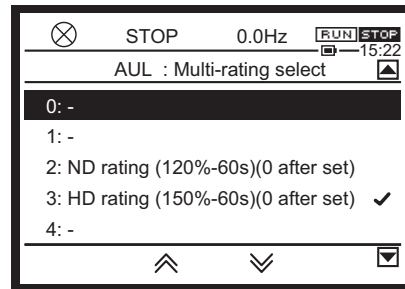

■ **Function**

Select an inverter overload protection characteristic suited for the torque characteristic of the machine.

■ **Parameter setting**

Title	Parameter name	Adjustment range	Default setting
AUL	Multi-rating select	0,1: - 2: ND rating (120%-60s) (0 after execution) 3: HD rating (150%-60s) (0 after execution) 4 - 8: -	3

5

Note) The setting value becomes 0 after execution, but a check mark is added to the previous setting value.

■ **Selecting a setting value**

**2: ND rating (120%-60s) (0 after execution)**

Select this value when applying the machine with variable torque characteristic.  
Example) Fan, pump, blower, etc.

**3: HD rating (150%-60s) (0 after execution)**

Select this value when applying the machine with constant torque characteristics.  
Example) Conveyor, load transporting machinery, crane, concrete mixer, compressor, making machine, machine tool, etc.

**Memo**

- The default setting of some parameters are different between HD rating and ND rating. Refer to [11. 6].

### 5. 3. 3 Acceleration/deceleration time adjustment automatically according to load

<AU1: Automatic Acc/Dec>

Basic parameter

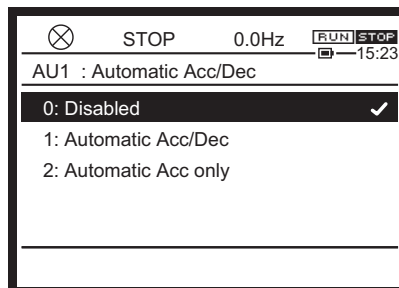

#### ■ Function

This is a parameter that automatically adjusts the acceleration/deceleration time according to the load condition to prevent an overcurrent trip during acceleration/deceleration.

5

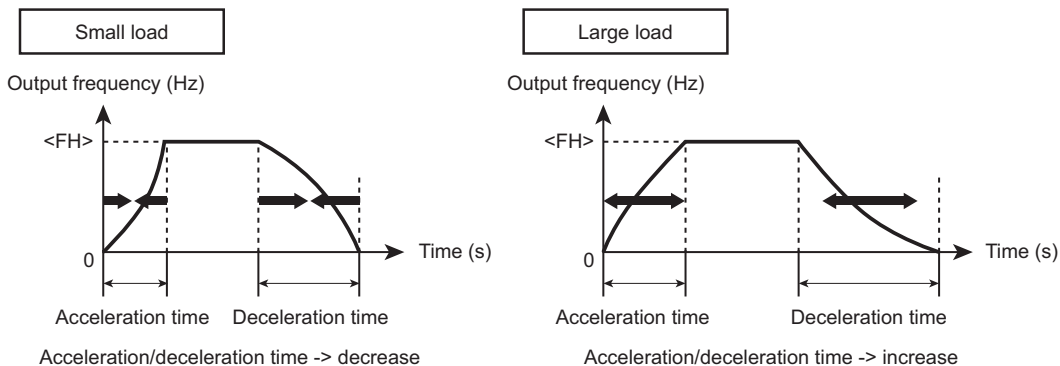

#### ■ Parameter setting

Title	Parameter name	Adjustment range	Default setting
AU1	Automatic Acc/Dec	0: Disabled 1: Automatic Acc/Dec 2: Automatic Acc only	1

#### ■ Selecting a setting value

##### 1: Automatic Acc/Dec

The acceleration/deceleration time is adjusted automatically in the range in which the output current does not exceed the rated current of the inverter. The adjustment range is 1/8 to 8 times as long as the time set with <ACC: Acceleration time 1> and <dEC: Deceleration time 1>. If you set suitable values for the average load with <ACC: Acceleration 1> and <dEC: Deceleration 1> in advance, it will be easy to deal with load fluctuation.

##### 2: Automatic Acc only

Only the acceleration time is adjusted automatically. The speed is decelerated according to the setting of <dEC: Deceleration time 1>.



Important

- Use this parameter with the motor connected.
- When the inverter is used with a load that fluctuates considerably, it may fail to adjust the acceleration or deceleration time in time, and therefore may be tripped.
- When using the optional braking resistor or braking unit, do not set <AU1: Automatic Acc/Dec> to "1". Otherwise, braking resistor overload may occur during deceleration.

**Memo**

- When the acceleration/deceleration time is automatically set, the acceleration/deceleration time is always changed according to the load. For machinery that requires constant acceleration/ deceleration time, accelerate or decelerate with the setting time of <ACC: Acceleration time 1> and <dEC: Deceleration time 1> instead of using this function. For details, refer to [5. 2. 4].

### 5.3.4 Selecting motor control method

<Pt: V/f Pattern>

Basic parameter

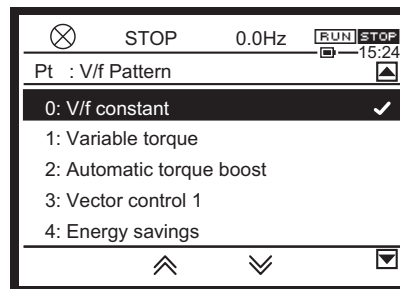

#### ■ Function

This is a parameter to select the motor control method according to the characteristics and application of the machinery.

#### Memo

- With <AU2: Torque boost macro>, you can set <Pt> of this parameter to "2: Automatic torque boost", "3: Vector control 1", and "4: Energy savings" and <F400: Offline auto-tuning > to "2" simultaneously.

5

#### ■ Parameter setting

Title	Parameter name	Adjustment range	Default setting
Pt	V/f Pattern	0: V/f constant 1: Variable torque 2: Automatic torque boost 3: Vector control 1 4: Energy savings 5: Dynamic energy savings (for fan and pump) 6: PM motor control 7: V/f 5-point setting 8: - 9: Vector control 2 (speed / torque) 10: PG feedback control 11: PG feedback vector control (speed / torque) 12: -	0

#### ■ Selecting a setting value

##### 0: V/f constant

This is a typical control method of an inverter, and the inverter is controlled so that the ratio of the output frequency (f) and the output voltage (V) becomes almost constant.

It is applied to loads with equipment like conveyors that requires the same torque at low speeds as at rated speeds.

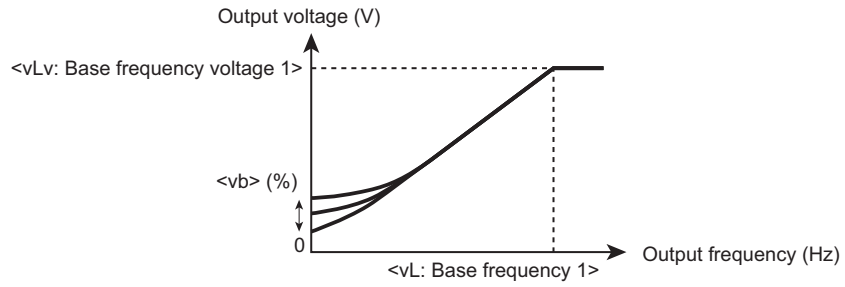

To increase the torque at low speeds, increase the setting value of <vb: Manual torque boost 1>. For details, refer to [5. 3. 6].

**1: Variable torque**

This is applied to loads such as fans, pumps and blowers in which the torque is proportional to the square of load motor speed.

5

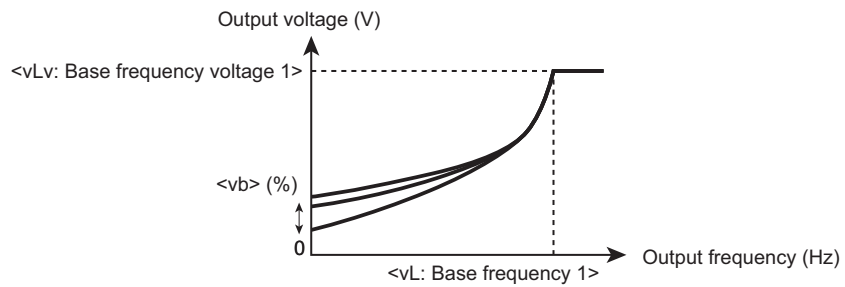

**2: Automatic torque boost**

The load current in the speed range from startup to base frequency is detected and the output voltage (torque boost) from the inverter is automatically adjusted. This gives steady torque for stable operation.

It is applied to loads that require torque.

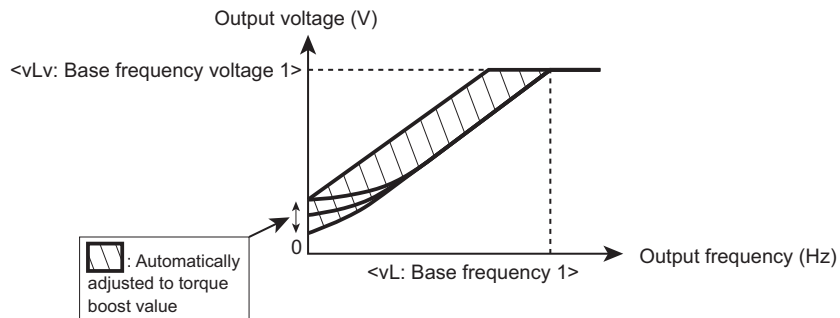

Operation may become unstable depending on loads. In this case, set <Pt> = "0: V/f constant" and increase the value of <vb: Manual torque boost 1>.

**Setting of motor parameters**

When <Pt> is "2", setting of motor parameters is required.

When the motor you are using is a 4P Toshiba premium efficiency motor which has the same capacity as the inverter, there is basically no need to set the parameters.

First, look at the motor name plate and set the following parameters.

- <vL: Base frequency 1> (Rated frequency)
- <vLv: Base frequency voltage 1> (Rated voltage)
- <F405: Motor rated capacity>
- <F415: Motor rated current>
- <F417: Motor rated speed>

Next, perform auto-tuning. Two parameter setting methods are provided.

### 1) Setting with <AU2: Torque boost macro>

Set <AU2: Torque boost macro> to "1". Set <Pt> to "2: Automatic torque boost" and <F400: Offline auto-tuning> to "2" simultaneously.

For details, refer to [5. 3. 5].

### 2) Setting with <F400: Offline auto-tuning>

Set <F400: Offline auto-tuning> to "5".

For details, refer to [6. 23. 1].

\* If an auto-tuning error occurs, set motor parameters individually by referring to [6. 23. 1]

"■Setting method 4: Manually setting motor parameter".

## 5

### 3: Vector control 1

High-torque and high-precision stable operation is realized in the speed range from startup to base frequency.

It is applied to load transporting machinery and elevators that require high torque and machine tools that require high precision.

- High starting torque can be obtained.
- It is effective when smooth stable operation from a low speed is required.
- The change of motor speed caused by load fluctuation is suppressed to realize high-precision operation.

When <Pt> is "3", setting of motor parameters is required.

When the motor you are using is a 4P Toshiba premium efficiency motor which has the same capacity as the inverter, there is basically no need to set the parameters.

In other cases, look at the motor name plate and set the following parameters.

- <vL: Base frequency 1> (Rated frequency)
- <vLv: Base frequency voltage 1> (Rated voltage)
- <F405: Motor rated capacity>
- <F415: Motor rated current>
- <F417: Motor rated speed>

Three parameter setting methods are provided.

### 1) Setting with <AU2: Torque boost macro>

Set <AU2: Torque boost macro> to "2". Set <Pt> to "3: Vector control 1" and <F400: Offline auto-tuning> to "2" simultaneously.

For details, refer to [5. 3. 5].

### 2) Setting with <F400: Offline auto-tuning>

Set <F400: Offline auto-tuning> to "5".

For details, refer to [6. 23. 1].

\* If an auto-tuning error occurs, set motor parameters individually by referring to [6. 23. 1] "■Setting method 4: Manually setting motor parameter".

### 3) Manual setting

Set each motor constant.  
For details, refer to [6. 23. 1].

### 4: Energy savings

Energy can be saved in all speed ranges by detecting load current and flowing the optimum current that fits the load.

When <Pt> is "4", setting of motor parameters is required.

When the motor you are using is a 4P Toshiba premium efficiency motor which has the same capacity as the inverter, there is basically no need to set the parameters.

In other cases, look at the motor name plate and set the following parameters.

- <vL: Base frequency 1> (Rated frequency)
- <vLv: Base frequency voltage 1> (Rated voltage)
- <F405: Motor rated capacity>
- <F415: Motor rated current>
- <F417: Motor rated speed>

Three parameter setting methods are provided.

#### 1) Setting with <AU2: Torque boost macro>

Set <AU2: Torque boost macro> to "3". Set <Pt> to "4: Energy savings" and <F400: Offline auto-tuning> to "2" simultaneously.

For details, refer to [5. 3. 5].

#### 2) Setting with <F400: Offline auto-tuning>

Set <F400: Offline auto-tuning> to "5".

For details, refer to [6. 23. 1].

\* If an auto-tuning error occurs, set motor parameters individually by referring to [6. 23. 1] "■Setting method 4: Manually setting motor parameter".

### 3) Manual setting

Set each motor constant.  
For details, refer to [6. 23. 1].

### 5: Dynamic energy savings (for fan and pump)

Energy can be saved in all speed ranges by detecting load current and flowing the optimum current that fits the load. Even in a low-speed range with especially decreased efficiency, more substantial energy savings than those provided when <Pt> is "4: Energy savings" can be achieved by controlling to maximize the efficiency.

The inverter cannot respond to rapid load fluctuations, so this setting should be used only for loads, such as fans and pumps that have less load fluctuations.

When <Pt> is "5", setting of motor parameters is required.

When the motor you are using is a 4P Toshiba premium efficiency motor which has the same capacity as the inverter, there is basically no need to set the parameters.

In other cases, look at the motor name plate and set the following parameters.

- <vL: Base frequency 1> (Rated frequency)
- <vLv: Base frequency voltage 1> (Rated voltage)

- <F405: Motor rated capacity>
- <F415: Motor rated current>
- <F417: Motor rated speed>

Two parameter setting methods are provided.

**1) Setting with <F400: Offline auto-tuning>**

Set <F400: Offline auto-tuning> to "5".

For details, refer to [6. 23. 1].

\* If an auto-tuning error occurs, set motor parameters individually by referring to [6. 23. 1] "■Setting method 4: Manually setting motor parameter".

**2) Manual setting**

Set each motor constant.

For details, refer to [6. 23. 1].

**6: PM motor control**

Permanent magnet motors (PM motors) that are highly efficient can be operated in sensor-less operation.

Setting of parameters for PM motor is required. For details, refer to [6. 23. 2].

**7: V/f 5-point setting**

V/f control characteristics can be created according to machinery. Set frequency and voltage in five points and run the inverter with V/f control characteristics derived by connecting these points.

Set five points from VF1 to VF5 with the following parameters <F190> to <F199>.

Title	Parameter name	Adjustment range	Unit	Default setting
F190	V/f 5-point VF1 frequency	0.0 - FH	Hz	0.0
F191	V/f 5-point VF1 voltage	0.0 - 125.0	% *1	0.0
F192	V/f 5-point VF2 frequency	0.0 - FH	Hz	0.0
F193	V/f 5-point VF2 voltage	0.0 - 125.0	% *1	0.0
F194	V/f 5-point VF3 frequency	0.0 - FH	Hz	0.0
F195	V/f 5-point VF3 voltage	0.0 - 125.0	% *1	0.0
F196	V/f 5-point VF4 frequency	0.0 - FH	Hz	0.0
F197	V/f 5-point VF4 voltage	0.0 - 125.0	% *1	0.0
F198	V/f 5-point VF5 frequency	0.0 - FH	Hz	0.0
F199	V/f 5-point VF5 voltage	0.0 - 125.0	% *1	0.0

\*1 100% with 200 V for 240 V class and 400 V for 480 V class.



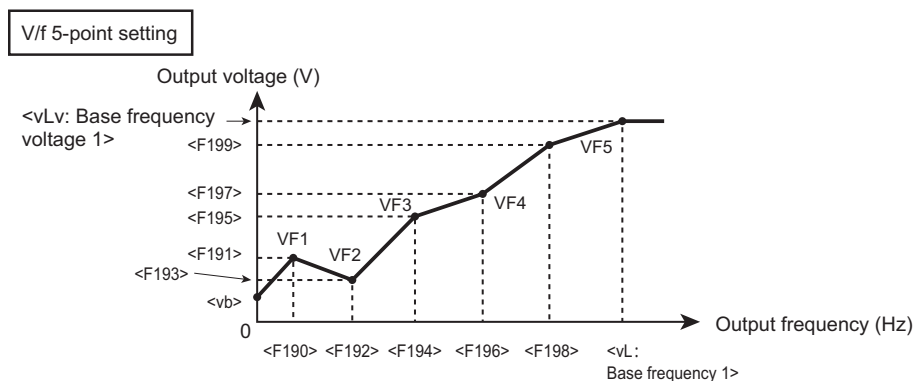

Important

- Set <vb: Manual torque boost 1> to approximately 0 to 3% of the base frequency voltage. If the setting value is too large, it may impair the linearity between points.
- If the inclination of the set V/f is above 8.25%/Hz, Points setting alarm 2 "A-02" occurs. When "A-02" alarm occurs, internal V/f is limited to 8.25%/Hz.

5

### 9: Vector control 2 (speed / torque)

It is applied to torque control.

Vector control realize high-torque and high-precision stable operation in the speed range from startup to base frequency.

It is applied to load transporting machinery and elevators that require high torque and machine tools that require high precision.

- High starting torque can be obtained.
- It is effective when smooth stable operation from a low speed is required.
- The change of motor speed caused by load fluctuation is suppressed to realize high-precision operation.

When <Pt> is "9", setting of motor parameters is required.

When the motor you are using is a 4P Toshiba premium efficiency motor which has the same capacity as the inverter, there is basically no need to set the parameters.

In other cases, look at the motor name plate and set the following parameters.

- <vL: Base frequency 1> (Rated frequency)
- <vLv: Base frequency voltage 1> (Rated voltage)
- <F405: Motor rated capacity>
- <F415: Motor rated current>
- <F417: Motor rated speed>

Two parameter setting methods are provided.

#### 1) Setting with <F400: Offline auto-tuning>

Set <F400: Offline auto-tuning> to "5".

For details, refer to [6. 23. 1].

\* If an auto-tuning error occurs, set motor parameters individually by referring to [6. 23. 1] "■Setting method 4: Manually setting motor parameter".

#### 2) Manual setting

Set each motor constant.

For details, refer to [6. 23. 1].

**10: PG feedback control**

Vector control is performed by using speed feedback signals from the motor.

Attach the PG feedback option to the inverter. Use a motor with speed sensor (encoder) and connect signals from the encoder to the PG feedback option.

In the following cases, use <Pt> = "11: PG feedback vector control (speed / torque)"

- To perform torque control
- To perform speed control that requires high precision
- When low-speed operation (with motor slip frequency or less) of regeneration is required

When <Pt> is "10", setting of motor parameters is required.

Look at the motor name plate and set the following parameters first.

- <vL: Base frequency 1> (Rated frequency)
- <vLv: Base frequency voltage 1> (Rated voltage)
- <F405: Motor rated capacity>
- <F415: Motor rated current>
- <F417: Motor rated speed>

Two parameter setting methods are provided.

**1) Automatic setting with auto-tuning**

Set <F400: Offline auto-tuning> to "5".

For details, refer to [6. 23. 1].

**2) Manual setting**

Set each motor constant.

For details, refer to "Digital Encoder Instruction Manual" (E6582148).

**11: PG feedback vector control (speed / torque)**

Vector control is performed by using feedback signals from the motor. It is applied to high-precision speed control and torque control.

Attach the PG feedback option to the inverter. Use a motor with speed sensor (encoder) and connect signals from the encoder to the PG feedback option.

Torque control is performed based on the torque command, so the motor speed depends on the relationship between the load torque and the motor generated torque.

When <Pt> is "11", setting of motor parameters is required.

Look at the motor name plate and set the following parameters first.

- <vL: Base frequency 1> (Rated frequency)
- <vLv: Base frequency voltage 1> (Rated voltage)
- <F405: Motor rated capacity>
- <F415: Motor rated current>
- <F417: Motor rated speed>

Two parameter setting methods are provided.

**1) Automatic setting with auto-tuning**

Set <F400: Offline auto-tuning> to "5".

For details, refer to [6. 23. 1].

**2) Manual setting**

Set each motor constant.

For details, refer to "Digital Encoder Instruction Manual" (E6582148).

### ■ Cautions for automatic torque boost and vector control

- Look at the motor name plate and be sure to set the following parameters.
  - <vL: Base frequency 1> (Rated frequency)
  - <vLv: Base frequency voltage 1> (Rated voltage)
  - <F405: Motor rated capacity>
  - <F415: Motor rated current>
  - <F417: Motor rated speed>
- The vector control exerts its characteristics effectively within the speed range of <vL: Base frequency 1>. The same characteristics will not be obtained in speed ranges over the base frequency.
- When using vector control, set <vL: Base frequency 1> in the range of 40 to 120 Hz.
- Use a three-phase motor with a capacity that is the same as the inverter's rated capacity or one rank below. The minimum applicable motor capacity is 0.1 kW.
- Use a motor that has 2 to 16 P.
- Operate one motor in combination with one inverter. Vector control cannot be used when one inverter is operated with more than one motor. When using a combination of several motors, set <Pt> to "0: V/f constant".
- The maximum length of wires between the inverter and motor is 30 m. If the wires are longer than 30 m, be sure to perform offline auto-tuning with the wires connected. However, the effects of voltage drop due to resistance of wiring cause motor-generated torque in the vicinity of base frequency to be somewhat lower.
- When a reactor or motor-end surge voltage suppression filter is connected between the inverter and a motor, the motor's generated torque may fall. Performing offline auto-tuning may also cause a trip "Etn1". When a trip has occurred, connect the inverter and the motor directly to perform offline auto-tuning, or set motor parameters by referring to the test record of the motor.
- Attach the speed sensor used for PG feedback control directly to the motor. If it is attached via a gear, etc., rigidity is not ensured, causing hunting of the motor or a trip of the inverter.
- If the motor is not connected or a motor with extremely small capacity is connected for operation for the purpose of operation check of the inverter, etc., set <Pt> to "0: V/f constant" temporarily. If it is set to Automatic torque boost, Vector control, PM control, PG feedback control, or PG feedback vector control, normal operation may not be possible.

5

#### Memo

- <Pt: V/f Pattern> is valid only with No.1 motor.
- If it is switched to No.2 to 4 motor, V/f constant control is applied regardless of the setting of <Pt>.

### ■ Cautions for PM motor control

- If the motor is not connected or a motor with extremely small capacity is connected for operation for the purpose of operation check of the inverter, etc., set <Pt> to "0: V/f constant" temporarily. If it is set to PM motor control, normal operation may not be possible.

### ■ Cautions for motor control

- Set the upper limit for frequency command to a value which is three or four times the value of <vL>.
- The value of run frequency is limited to a value which is ten times or less the values of <vL>, and the alarm "A-05" will appear when it is exceeded.

- If the inclination of the set V/f is over 8.25%/Hz, the alarm "A-02" will appear. When "A-02" alarm occurs, internal V/f is limited to 8.25%/Hz.

### 5.3.5 Setting parameters for torque boost and energy saving easily

<AU2: Torque boost macro>

Basic parameter

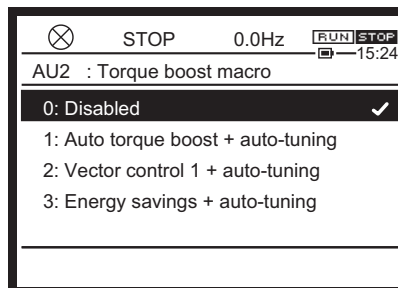

■ **Function**

This parameter is used to set V/f Pattern of the inverter and offline auto-tuning of motor parameters simultaneously for machinery that requires torque boost and energy saving.

■ **Parameter setting**

Title	Parameter name	Adjustment range	Default setting
AU2	Torque boost macro	0: Disabled 1: Automatic torque boost + offline auto-tuning 2: Vector control 1 + offline auto-tuning 3: Energy savings + offline auto-tuning	0

5



Important

- Before setting <AU2: Torque boost macro>, look at the motor name plate and be sure to set the following parameters.
    - <vL: Base frequency 1> (Rated frequency)
    - <vLv: Base frequency voltage 1> (Rated voltage)
    - <F405: Motor rated capacity>
    - <F415: Motor rated current>
    - <F417: Motor rated speed>
- Set other motor parameters as necessary.

■ **Selection of setting value**

**1: Automatic torque boost + offline auto-tuning**

This is applied to loads that require torque.

The load current in the speed range from startup to base frequency is detected and the output voltage (torque boost) from the inverter is automatically adjusted. This gives steady torque for stable operation.

- When <AU2: Torque boost macro> is set to "1", <Pt: V/f Pattern> is set to "2" automatically.
- The same characteristics can be obtained by setting <Pt> to "2: Automatic torque boost" and <F400: Offline auto-tuning> to "2: Auto-tuning at run command (0 after execution)". For details, refer to [6. 23. 1].

5

**2: Vector control 1 + offline auto-tuning**

This is applied to load transporting machinery and elevators that require high torque and machine tools that require high precision.

High-torque and high-precision stable operation is realized in the speed range from startup to base frequency.

- When <AU2: Torque boost macro> is set to "2", <Pt: V/f Pattern> is set to "3" automatically.
- The same characteristics can be obtained by setting <Pt> to "3: Vector control 1" and <F400: Offline auto-tuning> to "2: Auto-tuning at run command (0 after execution)". For details, refer to [6. 23. 1].

**3: Energy savings + offline auto-tuning**

This is applied to machinery such as fans and pumps that requires energy saving.

Energy can be saved in all speed ranges by detecting load current and flowing the optimum current that fits the load.

- When <AU2: Torque boost macro> is set to "3", <Pt: V/f Pattern> is set to "4" automatically.
- The same characteristics can be obtained by setting <Pt> to "4: Energy savings" and <F400: Offline auto-tuning> to "2: Auto-tuning at run command (0 after execution)". For details, refer to [6. 23. 1].

■ **If vector control cannot be set**

First read the precautions about vector control in [5. 3. 4].

If the desired torque cannot be obtained, refer to [6. 23], [6. 25].

If auto-tuning error "Etn1" appears, refer to [6. 23. 1], [6. 23. 2].

■ **Parameters set simultaneously with <AU2: Torque boost macro>**

<AU2: Torque boost macro> is a parameter to set <Pt: V/f Pattern> and <F400: Offline auto-tuning> simultaneously.

Therefore, if <AU2> is changed, the following relevant parameters are changed automatically.

<AU2>		Automatically set parameters			
		<Pt>		<F400>	
0	0 is displayed after resetting it	-	Check the setting value of <Pt>.	-	-
1	Automatic torque boost + offline auto-tuning	2	Automatic torque boost	2	Execute (0 after execution)
2	Vector control + offline auto-tuning	3	Vector control 1	2	Execute (0 after execution)
3	Energy savings + offline auto-tuning	4	Energy savings	2	Execute (0 after execution)

**Memo**

- For details of offline auto-tuning, refer to [6. 23. 1].

### 5. 3. 6 Increasing starting torque

<vb: Manual torque boost 1>

Basic parameter

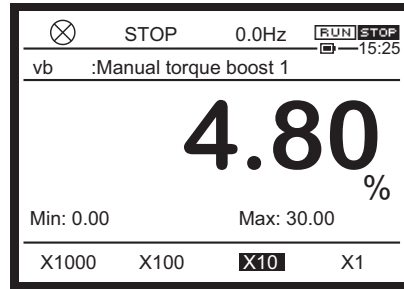

■ Function

The starting torque is increased by increasing the setting value when starting torque is required. It is valid when the setting value of <Pt: V/f Pattern> is "0: V/f constant", "1: Variable torque", or "7: V/f 5-point setting".

■ Parameter setting

Title	Parameter name	Adjustment range	Unit	Default setting
vb	Manual torque boost 1	0.00 - 30.00	%	*1

\*1 Depending on the capacity. Refer to [11. 6].

■ Reference of setting

100% is based on 200V, or 400V.  
Set the value within +2% of the default setting, generally.

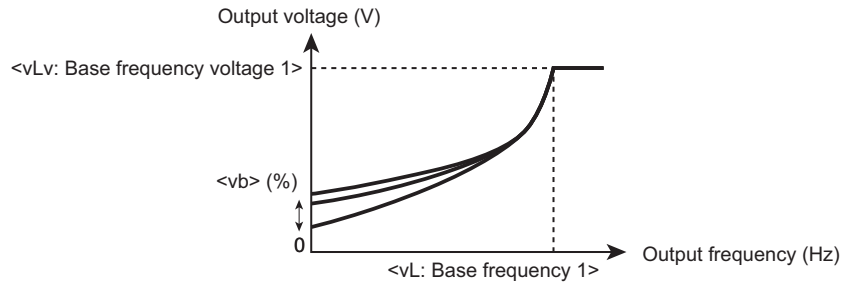

Important

- The optimum value is programmed for each inverter capacity by default setting. When a value larger than the reference value is set, an overcurrent trip may occur at startup.
- Repeated operation with excessive torque boost may cause failure of IGBT in the power circuit. When larger starting torque is required, consider using vector control. For details, refer to [5. 3. 4].

### 5. 3. 7 Operating by switching frequency command with external logic signal

<Sr0: Preset speed 0> to <Sr7: Preset speed 7>

Basic parameter

<F287: Preset speed 8> to <F294: Preset speed 15>  
<F964: Preset speed 16> to <F979: Preset speed 31>

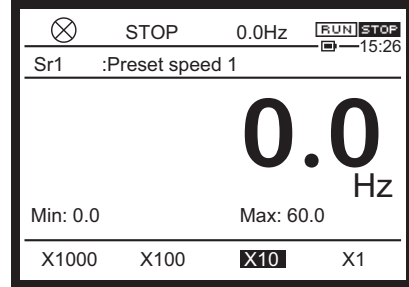

■ **Function**

The frequency commands are switched with external logic signals. For example, high speed and low speed are switched with 1-speed and 2-speed. Up to 31-speed can be set.

They can be used as interruption frequency commands because they have priority over other frequency commands.

■ **Parameter setting**

Title	Parameter name	Adjustment range	Unit	Default setting
Sr0	Preset speed 0	LL - UL	Hz	0.0
Sr1 to Sr7	Preset speed 1 - 7	LL - UL	Hz	0.0
F287 to F294	Preset speed 8 - 15	LL - UL	Hz	0.0
F964 to F979	Preset speed 16 - 31	LL - UL	Hz	0.0



Important

- They are valid in the case of run/stop with terminals. Set <CMOd: Run command select> to "0". For details, refer to [5. 2. 1].
- Preset speed 16 to 31 are set only by terminal input. They cannot be set via communication.
- Preset speed 16 to 31 do not support preset speed with the functions. If these functions are required, select preset speed 1 to 15.

■ **Reference of setting**

Set the frequency to be used for preset speed 1 to 31 with <Sr1: Preset speed 1> to <F979: Preset speed 31>.

When the preset speed command (external logic signal) is off, the frequency command set with <FMOd: Frequency command select 1> is valid. When <FMOd: Frequency command select 1> is "12: Sr0", the setting value of <Sr0: Preset speed 0> becomes the frequency command.

**Memo**

- The preset speed command is always given priority when other frequency commands are input at the same time.

5



■ Setting example of preset speed frequency

Here is a case of sink logic (when the slide switch [SW1] is set to SINK).

Terminal	Preset speed operation														
	1	2	3	4	5	6	7	8	9	10	11	12	13	14	15
S1	[S1]	✓	-	✓	-	✓	-	✓	-	✓	-	✓	-	✓	-
S2	[S2]	-	✓	✓	-	-	✓	✓	-	-	✓	✓	-	-	✓
S3	[S3]	-	-	-	✓	✓	✓	✓	-	-	-	✓	✓	✓	✓
S4	[S4]	-	-	-	-	-	-	✓	✓	✓	✓	✓	✓	✓	✓
S5	[S5]	-	-	-	-	-	-	-	-	-	-	-	-	-	-

Terminal	Preset speed operation															
	16	17	18	19	20	21	22	23	24	25	26	27	28	29	30	31
S1	[S1]	-	✓	-	✓	-	✓	-	✓	-	✓	-	✓	-	✓	-
S2	[S2]	-	-	✓	✓	-	-	✓	✓	-	-	✓	✓	-	-	✓
S3	[S3]	-	-	-	-	✓	✓	✓	✓	-	-	-	✓	✓	✓	✓
S4	[S4]	-	-	-	-	-	-	-	✓	✓	✓	✓	✓	✓	✓	✓
S5	[S5]	✓	✓	✓	✓	✓	✓	✓	✓	✓	✓	✓	✓	✓	✓	✓

✓: ON, -: OFF (When it is all OFF, then frequency command other than Preset speed operation is enabled.)

Set the input terminal functions as follows.

- <F114: Terminal S1 function 1> = "10: Preset speed switching 1"
- <F115: Terminal S2 function> = "12: Preset speed switching 2"
- <F116: Terminal S3 function> = "14: Preset speed switching 3"
- <F117: Terminal S4 function> = "16: Preset speed switching 4"
- <F118: Terminal S5 function> = "18: Preset speed switching 5"

Connect them as shown in the digram below.

In case of sink logic

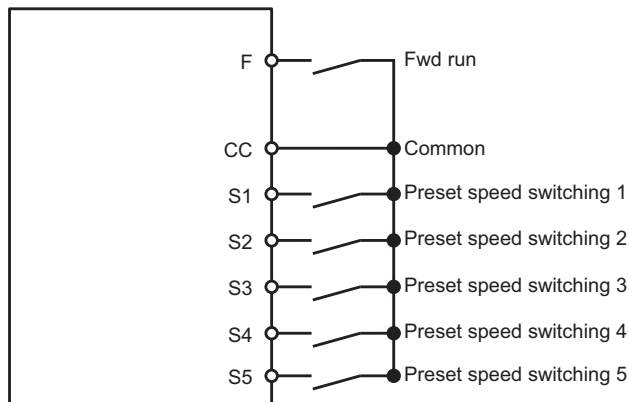

The following is an operation example of preset speed 1 - 3.

In this case, set <Sr1: Preset speed 1> to <Sr3: Preset speed 3>.

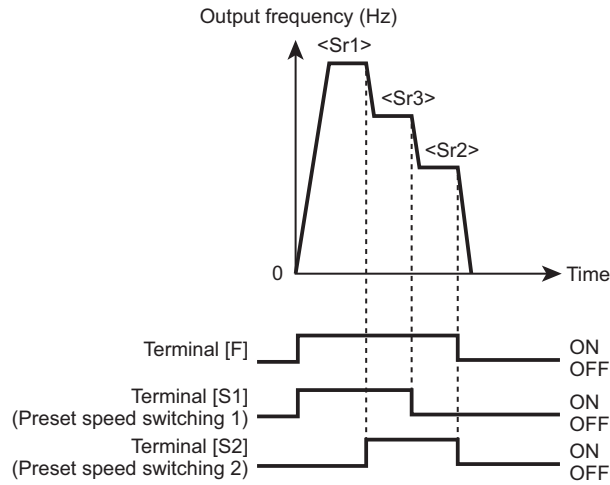

5

■ When changing frequency command during run

The frequency command can be changed during run with preset speed command. Set <F724: Frequency setting target by touch wheel> to "1: FC + Preset speed". When you operate the touch wheel during run with preset speed command, the frequency command can be changed. When you press the [OK] key, the setting value of the preset speed frequency can be changed.

Title	Parameter name	Adjustment range	Default setting
F724	Frequency setting target by touch wheel	0: Panel run frequency command (FC) 1: FC + Preset speed	0

0: Panel run frequency command (FC)  
Sets the frequency command from the operation panel.

1: FC + Preset speed  
Sets the frequency command from the operation panel during run with the preset speed command.

Memo

- While the frequency command is being adjusted, the frequency for running is switched if other preset speed command is input. However, the screen display and the adjustment target of the touch wheel are not switched. When you press the [OK] key, the display is switched to the current frequency for running.

■ Setting of operation function

For preset speed frequency commands of 1-speed to 15-speed, functions such as direction of rotation, acceleration/deceleration time, V/f control, and torque limit can be set. After setting <F560: Preset speed operation style> to "1: With function", set functions with <F561 Preset speed 1> to <F576: Preset speed 15>.

Title	Parameter name	Adjustment range	Default setting
F560	Preset speed operation style	0: Frequency only 1: With function	0

**0: Frequency only**

Only the frequency command is valid.

**1: With function**

For each preset speed commands of 1-speed to 15-speed, direction of rotation, acceleration/ deceleration time, V/f control, and torque limit can be set.

In this case, the direction of rotation of the motor is as set with <F561: Operation function (1-speed)> to <F576: Operation function (0-speed)>, not as the input of terminal [F] or terminal [R].

Title	Parameter name	Adjustment range	Default setting
F561 - F575	Operation function (1-speed) to Operation function (15-speed)	0: Fwd run +1: Rev run +2: Acc/Dec switching signal 1 +4: Acc/Dec switching signal 2	0
F576	Operation function (0-speed)	+8: V/f switching signal 1 +16: V/f switching signal 2 +32: Torque limit switching signal 1 +64: Torque limit switching signal 2	

5

Add the values of the functions to be used for setting. For example, when using the functions of Rev run (+1) and Acc/Dec switching signal 1 (+2), set "3" (+1+2=+3).

Do not set +8, or +16 to F576.

### 5. 3. 8 Setting PID control

<FPId: PID1 set value>

Basic parameter

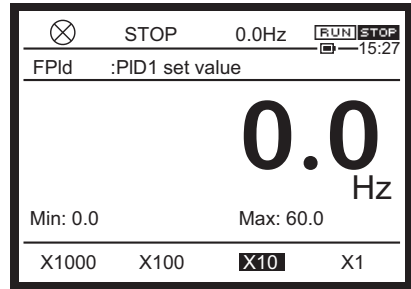

■ **Function**

This parameter is applied to process control including keeping airflow, pressure, and the amount of flow constant.

The set value and the feedback signal (4 - 20 mA, 0 - 10 V) from the detector are compared, and the frequency is changed toward the set value.

5

■ **Parameter setting**

Title	Parameter name	Adjustment range	Unit	Default setting
FPId	PID1 set value	F368 to F367	Hz	0.0

■ **Reference of setting**

1) **Selecting set value and feedback input**

Set the set value of PID control with <F389: PID1 set value select> and the feedback input value with <F360: PID1 feedback input select>.

- For <F389>, do not set the signal used for <F360>.
- When the feedback value and the set value match, the signal can be output. Assign function "144: PID 1, 2 frequency command agreement" to the output terminals.

Title	Parameter name	Adjustment range	Default setting
F389	PID1 set value select	0: selected by FMOd/F207 1: Terminal RR 2: Terminal RX 3: Terminal II 4: Terminal AI4 (option) 5: Terminal AI5 (option) 6 - 11: - 12: FPId 13, 14: - 15: Terminal Up/Down frequency 16: Pulse train 17: High resolution pulse train (option) 18, 19: - 20: Embedded Ethernet 21: RS485 communication (connector 1) 22: RS485 communication (connector 2) 23: Communication option	0
F360	PID1 feedback input select	0: - 1: Terminal RR 2: Terminal RX 3: Terminal II 4: Terminal AI4 (option) 5: Terminal AI5 (option) 6 - 16: - 17: High resolution pulse train (option)	0

5

**2) Setting contents of PID control**

Set <F359: PID control 1> to "1: Process PID control".

Title	Parameter name	Adjustment range	Unit	Default setting
F359	PID control 1	0: Disabled 1: Process PID control 2: Speed PID control 3: Easy positioning P control 4: Dancer control 5 - 10: - 11: Minus Process PID control 12: Minus Speed PID control 13: Minus Easy positioning P control 14: Minus Dancer control		0
F367	PID1 set value upper-limit	0.0 - FH	Hz	50.0/60.0
F368	PID1 set value lower-limit	0.0 - F367	Hz	0.0

Set <ACC: Acceleration time 1> and <dEC: Deceleration time 1> to the time that is suitable for the system. Refer to [5. 2. 4].

To limit the setting values, set the following parameters.

- To limit the set value: <F367: PID1 set value upper-limit>, <F368: PID1 set value lower-limit >
- To limit the output frequency: <UL: Upper limit frequency>, <LL: Lower limit frequency> (Refer to [5. 2. 3].)

**Memo**

- PID control can be temporarily turned off with an external signal. Assign "36: PID control OFF" to an input terminal.
- PID control should be OFF when very low speed drive is needed.
- If speed PID is selected, motor is possibly rotating forward and reverse. If you don't want to rotate reverse, set <F311: Reverse inhibited> or select process PID (<F359>=1, or 11).

**3) Adjusting PID control gain level**

Adjust the PID control gain level according to the set values, the feedback signals, and the object to be controlled.

Title	Parameter name	Adjustment range	Unit	Default setting
F362	PID1 proportional gain	0.01 - 100.0	-	0.30
F363	PID1 integral gain	0.01 - 100.0	s <sup>-1</sup>	0.20
F366	PID1 differential gain	0.00 - 2.55	s	0.00

5

**<F362: PID1 proportional gain>**

This parameter adjusts the proportional gain level of PID control. A correction value proportional to the particular deviation (the difference between the set value and the feedback value) is obtained by multiplying this deviation by the parameter setting.

A larger P-gain adjustment value gives faster response. Too large an adjustment value, however, results in an unstable event such as hunting.

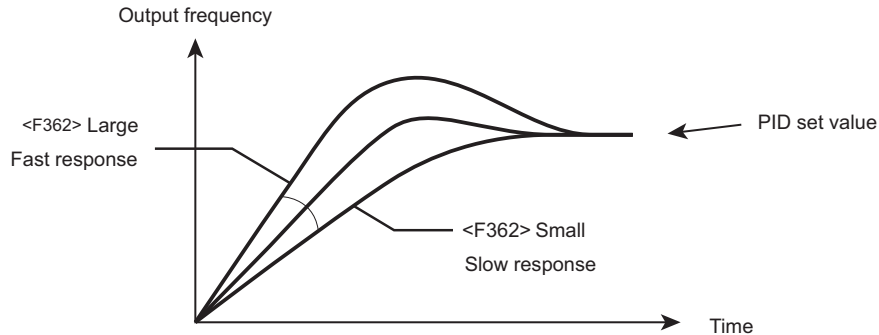

**<F363: PID1 integral gain>**

This parameter adjusts the integral gain level of PID control. Any remaining deviations (residual deviation offset) during proportional action are cleared to zero.

A larger I-gain adjustment value reduces residual deviations. Too large an adjustment value, however, results in an unstable event such as hunting.

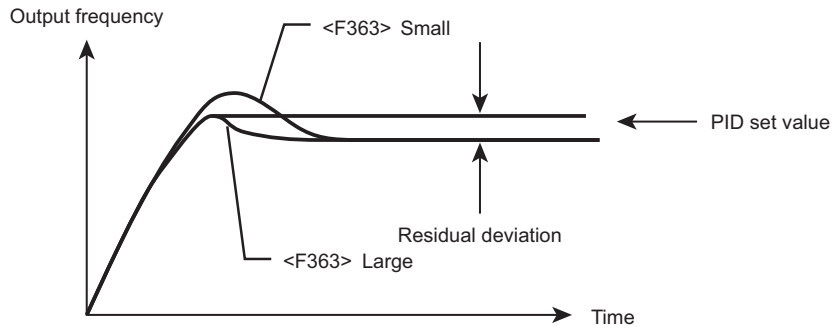

The integral/derivative amount of PID control can be reset with an external signal. Assign function number "52: PID differential/integral reset" to an input terminal.

**<F366: PID1 differential gain>**

This parameter adjusts the differential gain level of PID control. This gain increases the speed of response to a rapid change in deviation (difference between the set value and the feedback value). Note that setting the gain beyond necessity may cause fluctuations in output frequency, and thus operation to become unstable.

5

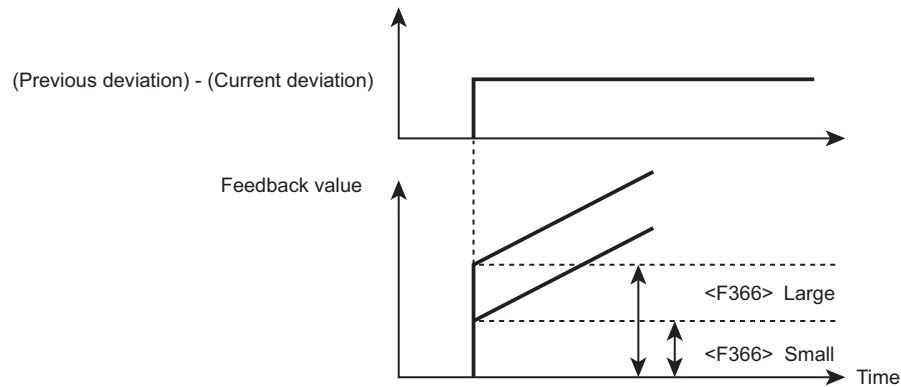

The integral/derivative amount of PID control can be reset with an external signal. Assign "52: PID differential/integral reset" to an input terminal.

**4) Adjusting feedback input**

Make adjustment by converting input level of the feedback value into frequency. Refer to [6. 6. 2].

Example of 0 - 10 Vdc voltage input setting

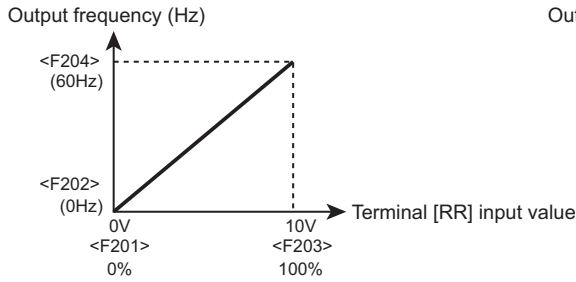

Example of -10 - +10 Vdc voltage input setting

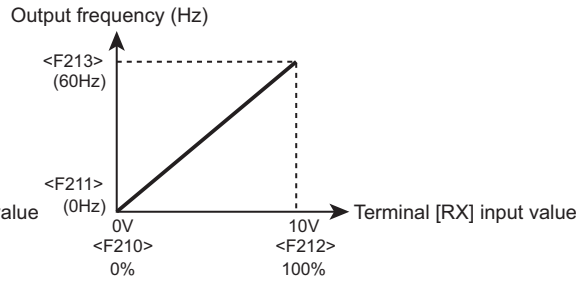

Example of 4 - 20 mAdc current input setting

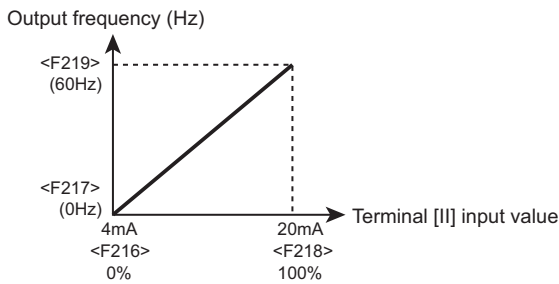

5

**5) Setting the time elapsed before PID control starts**

Waiting time until starting PID control system can be set to avoid PID control until the control system becomes stable at power on.

The inverter ignores feedback input signals and runs at the frequency determined by the frequency command value for the period of time set with <F369: PID1 start wait time>, and enters PID control after the elapsed time.

Title	Parameter name	Adjustment range	Unit	Default setting
F369	PID control start wait time	0 - 2400	s	0



### 5.3.9 Switching direction of rotation during panel run

<Fr: Panel Fwd/Rev run select>

Basic parameter

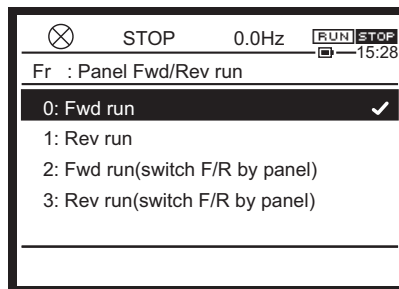

■ **Function**

This parameter is used to select the direction of rotation of the motor during panel run. The direction of rotation can be changed during run by using the [FWD/REV] key on the operation panel.

■ **Parameter setting**

Title	Parameter name	Adjustment range	Default setting
Fr	Panel Fwd/Rev run select	0: Fwd run 1: Rev run 2: Fwd run (switchable F/R by panel) 3: Rev run (switchable F/R by panel)	0

5

■ **Selecting a setting value**

**0: Fwd run**

When you press the [RUN] key on the operation panel, the motor runs forward. Forward run/reverse run cannot be switched.

**1: Rev run**

When you press the [RUN] key on the operation panel, the motor runs reversely. Forward run/reverse run cannot be switched.

**2: Fwd run (switchable F/R by panel)**



When you press the [RUN] key on the operation panel, the motor runs forward. When you press the [FWD/REV] key during forward run, the motor starts running reversely. When you press the [FWD/REV] key again, the motor starts running forward. The command given before "MOFF" display is remained at the power off.

**3: Rev run (switchable F/R by panel)**



When you press the [RUN] key on the operation panel, the motor runs reversely. When you press the [FWD/REV] key during reverse run, the motor starts running forward. When you press the [FWD/REV] key again, the motor starts running reversely. The command given before "MOFF" display is remained at the power off.

■ **Direction of rotation of motor**

You can check the direction of rotation of the motor with the following display.

-  /  display of the rotation direction icon.
- Direction of rotation of the rotating icon
- "Forward"/"Reverse" display of the direction of rotation in [Monitor mode].

When the [FWD]/[REV] key is valid,   is displayed at the upper right of the LCD screen.

When the motor is running forward,  is highlighted. When it is running reversely,  is highlighted.

### Memo

- This function is valid when the motor is run/stopped from the operation panel or extension panel (<CMoD: Run command select> = "1").
- In the case of terminal run, setting with <Fr: Panel Fwd/Rev run select> is invalid.  
Switch forward/reverse run with the terminal [F] and the terminal [R].  
Terminal [F]: Fwd run  
Terminal [R]: Rev run  
For details of terminal run, refer to "Chapter 7".

### 5. 3. 10 Automatic setting of main parameters by region used

 **WARNING**



Mandatory action

- Make sure to set the setup menu correctly. If you set the setup menu incorrectly, this will damage the inverter or cause the inverter to perform unexpected movement.

<SEt: Region setting check>

Basic parameter

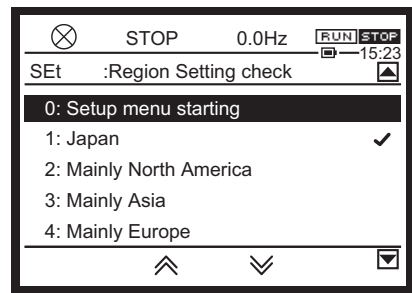

5

■ **Function**

When you select a region using in the setup menu at initial Power on, parameters such as the base frequency of the motor is set automatically according to the selected region. You can check the region that has been set or reset it by starting the setup menu.

■ **Parameter setting**

Title	Parameter name	Adjustment range	Default setting
SEt	Region setting check	0: Setup menu starting 1: Japan (read only) 2: Mainly North America (read only) 3: Mainly Asia (read only) 4: Mainly Europe (read only) 5: Mainly China (read only)	0

■ **Selecting a setting value**

**0: Setup menu starting**

The setup menu to select the region where the inverter is used is started. When you select the region, parameters such as the base frequency and the base frequency voltage of the motor that are described on the separate table are automatically set.

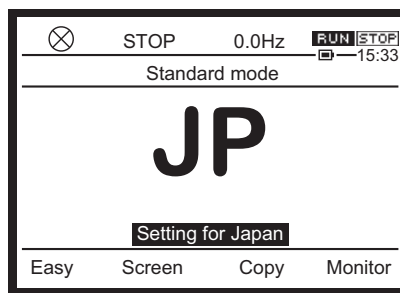
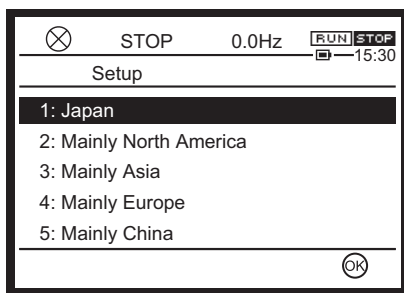

Important

- While the setup menu is started, you cannot return to the previous step even if you press the [ESC] key.
- Note that all parameters return to status of default setting and the trip history data is cleared.

5

- 1: Japan (read only)
- 2: Mainly North America (read only)
- 3: Mainly Asia (read only)
- 4: Mainly Europe (read only)
- 5: Mainly China (read only)

All of 1 to 5 are display to check the setting. Even if you select any of them and press the [OK] key, new setting cannot be made.

There is a mark at the right end of the region selected in the setup menu.

■ Parameters set with setup menu

Parameter title	Function	Mainly North America	Mainly Asia	Mainly Europe	China	Japan
FH	Maximum frequency (Hz)	80.0	80.0	80.0	50.0	80.0
F307	Supply voltage compensation	2	2	2	2	3
F319	Regenerative over-flux upper limit (%)	120	120	120	140	140
F417	Motor rated speed (min <sup>-1</sup> )	*1	*1	*1	*1	*1
vLv, F171, F175, F179	Base frequency Voltage (V)	230	230	230	200	200
		460	400	400	380	400
vL, UL, F170, F174, F178, F204, F213, F219, F225, F231, F237, F330, F335, F364, F367, F370, F426, F428, F814, A316, A319, A322, A346, A349, A352, A376, A379, A382	Frequency (Hz)	60.0	50.0	50.0	50.0	60.0

Parameter title	Function	Mainly North America	Mainly Asia	Mainly Europe	China	Japan
F606, F643	Frequency (max of set value) (Hz)	60.0	50.0	50.0	50.0	60.0
F405	Motor rated Capacity (kW)	3.7	4.0	4.0	3.7	3.7
		0.4	0.4	0.4	0.37	0.4
F704	Reference Website	0	1	1	1	1

\*1 Depending on the region and the capacity. Refer to [11. 6].

## Memo

- The setting values of the parameters set with the setup menu can be changed as in the case of other parameters.

## 5.4 Setting of extended parameters that are especially important

This section explains the parameters that are especially important among the extended parameters. For other extended parameters not introduced here, refer to "Chapter 6".

### 5.4.1 Switching two frequency commands

<FM0d: Frequency command select 1>

Basic parameter

Easy mode

<F207: Frequency command select 2>

<F200: Frequency command priority select>

<F208: Frequency command switching frequency>

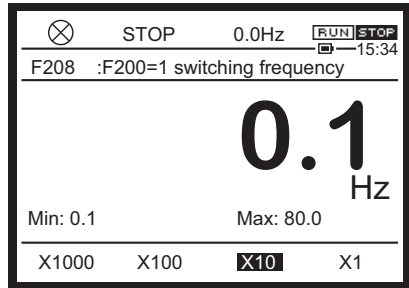
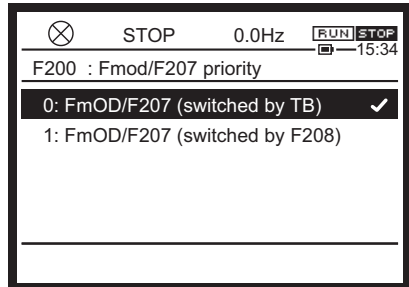

#### ■ Function

Two frequency commands, for example manual setting with external potentiometer and automatic setting with 4 - 20 mA signals, can be switched.

Switch two frequency commands set with <FM0d: Frequency command select 1> and <F207: Frequency command select 2> with input terminal signals or switching frequency set with <F200: Frequency command priority select>.

5

■ Parameter setting

Title	Parameter name	Adjustment range	Default setting
FMOd	Frequency command select 1	0: - 1: Terminal RR 2: Terminal RX	1
F207	Frequency command select 2	3: Terminal II 4: Terminal AI4 (option) 5: Terminal AI5 (option) 6 - 9: - 10: Touch wheel 1 (power off or press OK to save) 11: Touch wheel 2 (press OK to save) 12: Sr0 13, 14: - 15: Terminal Up/Down frequency 16: Pulse train 17: High resolution pulse train (option) 18, 19: - 20: Embedded Ethernet 21: RS485 communication (connector 1) 22: RS485 communication (connector 2) 23: Communication option	3

5

Title	Parameter name	Adjustment range	Default setting
F200	Frequency command priority select	0: FMOd/F207 (switched by TB) 1: FMOd/F207 (switched by <F208>)	0

Title	Parameter name	Adjustment range	Unit	Default setting
F208	Frequency command switching frequency	0.1 - FH	Hz	0.1

■ Setting of two frequency commands

Set with <FMOd: Frequency command select 1> and <F207: Frequency command select 2>. The adjustment range is the same.  
Refer to "■ Selection of setting value" of <FMOd: Frequency command select 1> in [5. 2. 1].

■ Setting of <F200: Frequency command priority select>

**0: FMOd/F207 (switched by TB)**

The frequency commands set with <FMOd: Frequency command select 1> and <F207: Frequency command select 2> are switched with input terminal signals.  
Setting of the function number of the input terminal is required.

**1: FMOd/F207 (switched by <F208>)**

The frequency commands set with <FMOd: Frequency command select 1> and <F207: Frequency command select 2> are switched with frequency.  
Set the switching frequency with <F208: Frequency command switching frequency>.

■ **Switching with input terminal <F200> = "0"**

Set <F200: Frequency command priority select> to "0".

Assign "104: FM0d/F207 priority switching" to an unused input terminal. For details, refer to [7. 2. 1].

- When the input terminal is OFF, run the motor with the frequency command set with <FM0d: Frequency command select 1>.
- When the input terminal is ON, run the motor with the frequency command set with <F207: Frequency command select 2>.

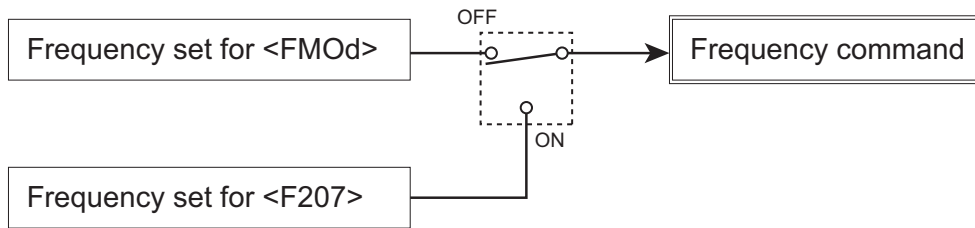

5

■ **Automatic switching with switching frequency <F200> = "1"**

Set <F200: Frequency command priority select> to "1" and set the frequency with <F208: Frequency command switching frequency>.

- If the frequency command set with <FM0d: Frequency command select 1> is larger than the value set with <F208>, the value set with <FM0d> becomes the frequency command.
- If the frequency command set with <FM0d> is larger than the value set with <F208>, the value set with <F207: Frequency command value 2> becomes the frequency command.

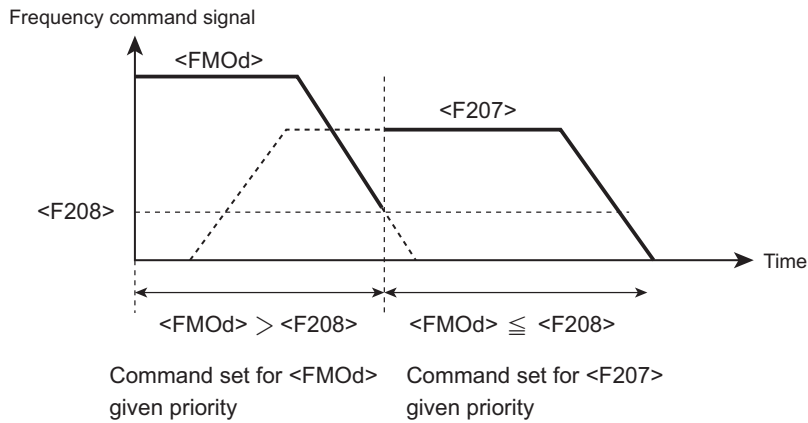



## 5. 4. 2 Restarting smoothly after momentary power failure

 **CAUTION**



Mandatory  
action

- When the auto-restart after momentary stop function is selected, stand clear of motors and machines at momentary power failure.  
The motors and machines which have stopped due to momentary power failure will restart suddenly after power is restored, and this will result in injury.
- Attach caution labels indicating functions programmed for Auto restart, on inverters, motors and machines.  
Please prevent accidents with the caution labels.

### <F301: Auto-restart>

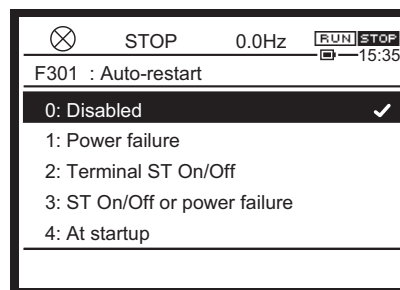

5

#### ■ Function

The motor that is coasting due to momentary power failure is accelerated immediately after the power is restored (auto-restart function).

In addition, this parameter detects the motor speed and direction of rotation of the motor during coasting at the time of startup, and allows switching from commercial power operation to inverter operation without stopping the motor(motor speed search function).

#### ■ Parameter setting

Title	Parameter name	Adjustment range	Default setting
F301	Auto-restart	0: Disabled 1: Power failure 2: Terminal ST On/Off 3: Terminal ST On/Off or power failure 4: At startup	0

#### ■ Selecting a setting value

##### 1: Power failure

The motor that is coasting due to momentary power failure is accelerated immediately after the power is restored.

It is operated after power is restored after power circuit undervoltage is detected. Turn on the run command.

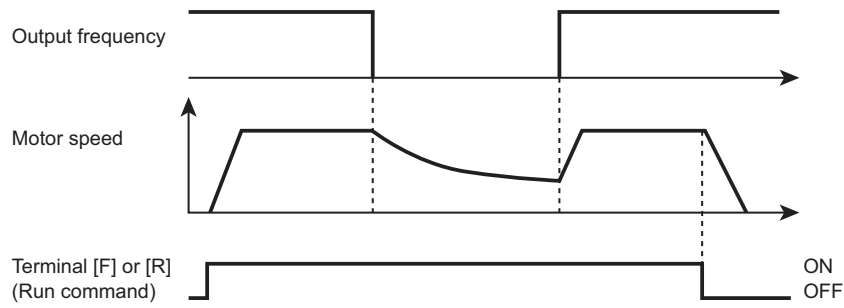

**2: Terminal ST On/Off**

The motor speed and direction of rotation of the coasting motor are detected to start it smoothly (motor speed search function).

The input terminal to which "ST: Standby" is assigned is turned off. It is operated when the input terminal is turned on again. Turn on the run command.

Since "ST: Standby" is always ON in default setting, make setting as follows.

- Set <F110: Always active function 1> to "0: No function" (Refer to [6. 3. 1])
- Assign "6: ST: Standby" to an unused input terminal

5

For assignment of a function to an input terminal, refer to [7. 2. 1].

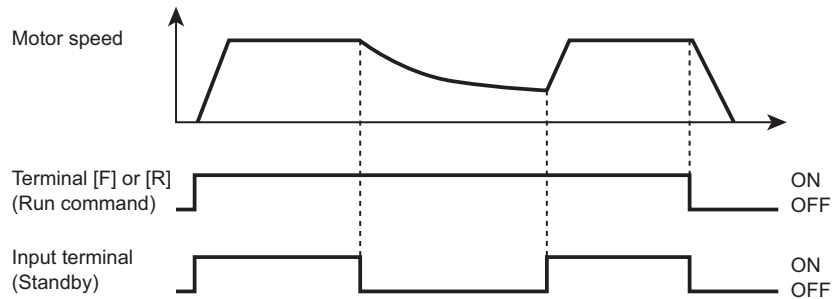

**3: Terminal ST On/Off or power failure**

It is operated both in "1" and "2"

**4: At startup**

A motor speed search is executed each time at startup.

When the motor is rotated by the external factor before running by the inverter, it can be started without trip.



## Important

- At restart, it takes about 1 second for the inverter to check the motor speed. For this reason, the startup takes more time than usual.
- Use this function when operating a system with one motor connected to one inverter. This function may not operate properly in a system configuration when multiple motors are connected to one inverter.
- When using this parameter, do not set <F605: Output phase loss detection> to "1", "2", or "4". For details, refer to [6. 30. 5].
- Do not apply it for cranes.  
The load may be lowered during waiting time from input of the run command to startup. To apply the inverter to cranes, therefore, set <F301: Auto-restart> to "0: Disabled". Do not use the retry function, either.
- This function is always enabled at torque control. (independent to <F301> setting)

## Memo

- When the motor is restarted from retry, this function is operated regardless of the setting of this parameter.
- It is not malfunction that abnormal noise might be heard from the motor during the motor speed search at the auto-restart.

### 5. 4. 3 Customizing display

(1) Selecting contents displayed in [Standard mode]

<F710: Standard mode display>  
 <F720: Standard mode display of extension panel>

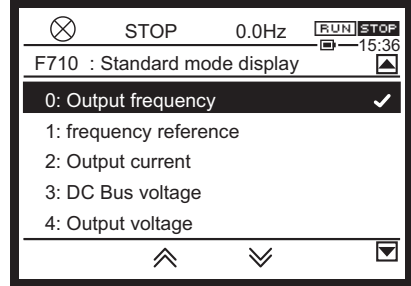

■ Function

The display contents in [Standard mode] can be changed. Different contents can be displayed on the operation panel of the inverter unit and the extension panel (optional).

Select the display contents in [Standard mode] when the power is turned on. In the default setting, the output frequency is displayed.

■ Parameter setting

Title	Parameter name	Adjustment range	Default setting
F710	Standard mode display	0 - 162*1	0
F720	Standard mode display of extension panel	0 - 162 *1	0

\*1 For details, refer to the table at the end of this subsection.

■ Reference of setting

With <F710: Standard mode display>, set the contents to be displayed in [Standard mode] on the operation panel when the power is turned on. Set the extension panel with <F720: Standard mode display of extension panel>.

In either case, "0: Output frequency" in the default setting.

**Memo**

- Different contents can be displayed on the operation panel of the inverter unit and the extension panel (optional).

■ **Setting list of <F710: Standard mode display> and <F720: Standard mode display of extension panel>**

Setting value	Function name	Display unit	Setting value	Function name	Display unit
0	Output frequency	0.1 Hz	71	Motor speed (estimated value)	1
1	Frequency command value	0.1 Hz	72	Communication option Receiving counter	1
2	Output current	1%/<F701> setting	73	Communication option Abnormal counter	1
3	Input voltage (DC detection)	1%/<F701> setting	76	Terminal S4/S5 pulse train input value	0.10%
4	Output voltage	1%/<F701> setting	77	My function COUNT1	1
5	Stator frequency	0.1 Hz	78	My function COUNT2	1
6	Speed feedback frequency (real time)	0.1 Hz	79	Dancer control PID result frequency	0.1 Hz
7	Speed feedback frequency (1-second filter)	0.1 Hz	80	Embedded Ethernet Transmission counter	1
8	Torque	1%	81	Embedded Ethernet Receiving counter	1
9	Torque command	1%	82	Embedded Ethernet Abnormal counter	1
10	Output frequency during run. Frequency command value during stop.	Hz/free unit	83	Connected option number	1
11	Torque current	1%	84	My function COUNT3	1
12	Exciting current	1%	85	My function COUNT4	1
13	PID feedback value	0.1 Hz	86	My function COUNT5	1
14	Motor overload factor (OL2 data)	1%	90	Cumulative power ON time	100 hours
15	Inverter overload factor (OL1 data)	1%	91	Cumulative cooling fan run time	100 hours
16	Braking resistor overload factor (OLr data)	1%	92	Cumulative run time	100 hours
17	Braking resistor load factor (%ED)	1%	93	Cumulative overcurrent time	100 hours
18	Input power	0.1 kW	95	Pump 0 run time	100 hours
19	Output power	0.1 kW	96	Pump 1 run time	100 hours
20	Input cumulative power	<F749> setting	97	Pump 2 run time	100 hours
21	Output cumulative power	<F749> setting	98	Pump 3 run time	100 hours

Setting value	Function name	Display unit	Setting value	Function name	Display unit
22	-	-	99	Pump 4 run time	100 hours
23	-	-	100	Number of starting	10000 times
24	Terminal RR input value	1%	101	Number of Fwd starting	10000 times
25	Terminal RX input value	1%	102	Number of Rev starting	10000 times
26	Terminal II input value	1%	103	External equipment counter	Time
27	Motor speed command	-	105	Pump 5 run time	100 hours
28	Terminal FM output value	1	106	Pump 6 run time	100 hours
29	Terminal AM output value	1	107	Pump 7 run time	100 hours
30	-	-	108	Pump 8 run time	100 hours
31	Communication data output	*1	109	Pump 9 run time	100 hours
32	Slot A option CPU version	-	110	Number of trip	Time
33	Slot B option CPU version	-	111	Number of serious failure trip	1
34	Motor load factor	%	112	Number of slight failure trip	1
35	Inverter load factor	%	113	Number of specified trip 1	1
36	Inverter rated current	A	114	Number of specified trip 2	1
37	Inverter rated current (with carrier frequency correction )	A	115	Number of specified trip 3	1
38	Actual carrier frequency	kHz	120	Internal temperature 1	°C
39	Slot C option CPU version	-	124	Power circuit board temperature	°C
40	Embedded Ethernet CPU version	-	130	External PID3 set value	0.1 Hz
41	Terminal FP pulse train output value	pps	131	External PID3 feedback value	0.1 Hz
43	Terminal FM/AM gain setting value	-	132	External PID3 result value	0.1 Hz
44	Terminal AI4 input value	1%	133	External PID4 set value	0.1 Hz
45	Terminal AI5 input value	1%	134	External PID4 feedback value	0.1 Hz
46	My function monitor output 1	-	135	External PID4 result value	0.1 Hz
47	My function monitor output 2	-	150	Signed output frequency	0.1 Hz
48	My function monitor output 3	-	151	Signed frequency command value	0.1 Hz
49	My function monitor output 4	-	152	Signed stator frequency	0.1 Hz
62	PID result frequency	0.1 Hz	153	Signed speed feedback frequency (real time)	0.1 Hz

Setting value	Function name	Display unit	Setting value	Function name	Display unit
63	PID set value	0.1 Hz	154	Signed speed feedback frequency (1-second filter)	0.1Hz
64	Light-load high-speed switching load torque	1%	155	Signed torque	1%
65	Light-load high-speed torque during constant speed run	1%	156	Signed torque command	1%
66	Pattern operation group number	0.1	158	Signed torque current	1%
67	Pattern operation remaining cycle number	1	159	Signed PID feedback value	0.1 Hz
68	Pattern operation preset speed number	1	160	Signed terminal RX input value	1%
69	Pattern operation remaining time	0.1	161	Signed terminal AI4 input value	1%
70	Inverter rated voltage	1	162	Signed terminal AI5 input value	1%

\*1 For details, refer to "RS485 Communication Function Instruction Manual" (E6582143).

## (2) Selecting contents displayed in the status area

<F723: Status area display of operation panel>

### ■ Function

Sets the content displayed third from the left end of the status area. Default setting displays the frequency command value.

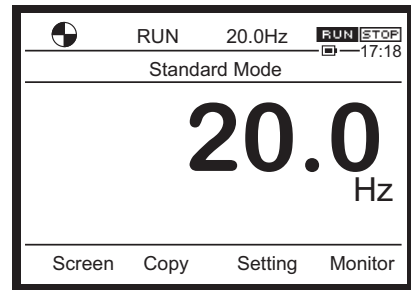

### ■ Parameter setting

Title	Parameter name	Adjustment range	Default setting
F723	Status area display of operation panel	0 - 162*1	1

\*1 For details, refer to the table at the end of the previous subsection (1).

(3) Displaying frequency by converting to other unit

- <F702: Free unit multiplication factor>
- <F703: Target of free unit>
- <F705: Free unit inclination polarity>
- <F706: Free unit bias>

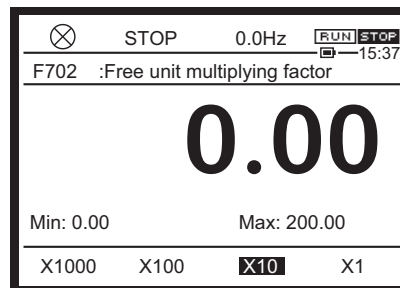

■ Function

The monitor display and the frequency display of parameters can be converted into the motor speed or load speed.

The unit of the set value or that of feedback can be changed at PID control for easy setting.

5

■ Parameter setting

Title	Parameter name	Adjustment range	Unit	Default setting
F702	Free unit multiplication factor	0.00: Disabled 0.01 - 200.0	times	0.00
F703	Target of free unit	0: All frequencies 1: PID frequencies	-	0
F705	Free unit inclination polarity	0: Negative inclination (downward slope) 1: Positive inclination (upward slope)	-	1
F706	Free unit bias	0.00 - FH	Hz	0.00

■ Reference of setting

The value obtained by multiplying the displayed frequency by the setting value of <F702: Free unit multiplication factor> is displayed.

"Value displayed" = "Monitor-displayed" or "parameter-set frequency" x <F702>

■ Parameters converted with <702: Free unit multiplication factor>

When <F703: Target of free unit> is "0"

It applies to all the frequency.

- Frequency monitor display: Frequency command value, Output frequency, PID feedback value, Stator frequency, During stop: Frequency command value (During run: Output frequency)
- Frequency-related parameters: <FC>, <FH>, <UL>, <LL>, <FPId>, <Sr0> - <Sr7>, <F100>, <F101>, <F102>, <F190>, <F192>, <F194>, <F196>, <F198>, <F202>, <F204>, <F208>, <F211>, <F213>, <F217>, <F219>, <F223>, <F225>, <F229>, <F231>, <F235>, <F237>, <F240>, <F241>, <F242>, <F243>, <F244>, <F250>, <F260>, <F265>, <F267>, <F268>, <F270> - <F275>, <F287> - <F294>, <F321>, <F322>, <F330>, <F331>, <F346>, <F350>, <F352>, <F355>, <F364>, <F365>, <F367>, <F368>, <F370>, <F371>, <F374>, <F383>, <F391> - <F393>, <F426>, <F428>, <F431>, <F432>, <F466>, <F505>, <F513>, <F517>, <F606>, <F623>, <F624>, <F643>, <F649>, <F812>, <F814>, <F964> - <F979>



<A220>, <A222>, <A226>, <A227>, <A229>, <A230>, <A316>, <A317>, <A319>, <A320>, <A322>, <A323>, <A326>, <A327>, <A923> - <A927>  
 <C154>, <C155>, <C697>

**When <F703: Target of free unit> is "1"**

It applies only to the PID control-related frequency.

- PID control-related parameters: <FPId>, <F364>, <F365>, <F367>, <F368>, <F374>, <A316>, <A317>, <A319>, <A320>, <A326>, <A327>

**Memo**

- Base frequency is always Hz.  
 <vL: Base frequency 1>, <F170: Base frequency 2>, <F174: Base frequency 3>, <F178: Base frequency 4>

■ **Setting example of <F702: Free unit multiplicaton factor>**

1) **Motor speed display**

When output frequency 60 Hz is displayed as 1800min<sup>-1</sup> at the time of 4-pole motor operation

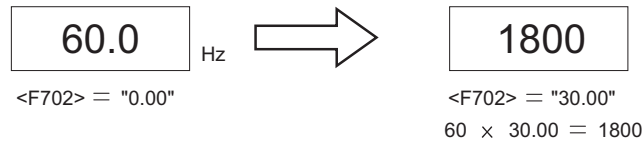

2) **Load speed display**

When output frequency 60 Hz is displayed as conveyor speed of 6m/min

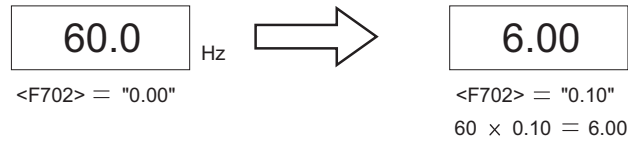

■ **Setting of <F705: Free unit inclination polarity> and <F706: Free unit bias>**

The inclination of the free unit can be changed, and the bias can be set.

The following are examples of setting and screen display (when <F702> = "10.0", <FH> = "80.0").

Positive inclination

<F705>="1", <F706>="0.00"

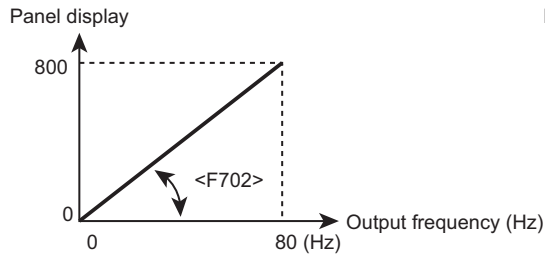

Positive inclination with bias

<F705>="1", <F706>="20.00"

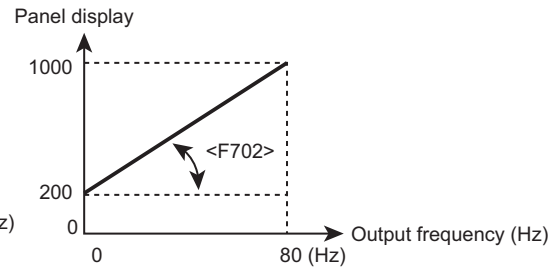

Negative inclination

<F705>="0", <F706>="80.00"

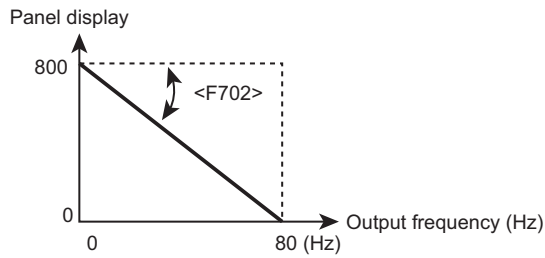

5



Important

- This parameter is a function to display the output frequency of the inverter multiplied by the factor. It does not display the actual motor speed or line speed precisely.

# 6

## [Advanced] How to use parameters

I

II

This inverter has basic parameters and other three types of parameters such as extended parameters (with F), advanced parameters, (with A), and communication parameters (with C). These parameters are used for sophisticated operations, detailed settings, special purposes, etc. This chapter explains how to use the parameters that are not mentioned in the previous chapters.

1

2

3

4

5

6

7

8

9

10

11

12

13

14

15

### 6.1 Output signals from the control terminals

Various signals are output for motor operation.

For details on the output terminal functions, refer to [7. 2. 2].

#### 6.1.1 Output the running signal and the brake signal (output the low-speed signal)

<F100: Low-speed signal output frequency>

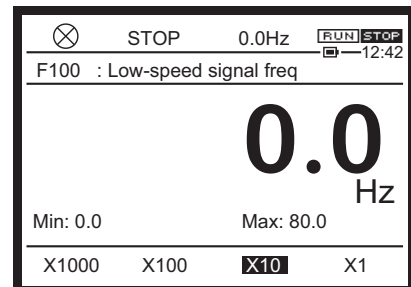

##### ■ Function

When the output frequency becomes over <F100: Low-speed signal output frequency>, the low-speed signal is output from the output terminal.

- When <F100: Low-speed signal output frequency> is set to "0.0", the ON signal is output when the output frequency is over 0.0 Hz. Therefore, this setting can be used as a running signal.
- This signal can be also used as brake/release signal for the electromagnetic brake.

##### ■ Parameter setting

Title	Parameter name	Adjustment range	Unit	Default setting
F100	Low-speed signal output frequency	0.0-FH	Hz	0.0

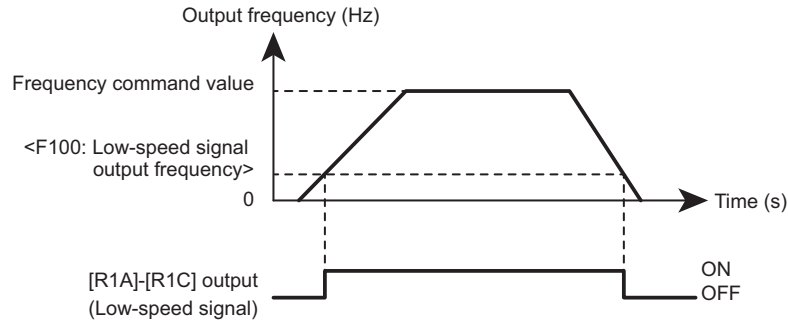

■ **Output terminal parameter setting**

Low-speed signal is the default setting for terminal [R1].

Title	Parameter name	Adjustment range	Default setting
F133	Terminal R1 function 1	0-255 *1	4

\*1 For details on the output terminal functions, refer to [7. 2. 2].

6

**Memo**

- When you want to output the inversion signal (OFF signal), set "5".
  - The signals can be also output from the other output terminals depending on the parameter setting.
- When you want to output the signals from the relay logic output terminals [FLA]-[FLB]-[FLC], set "4" or "5" for <F132: Terminal FL function>. When you want to output the signals from the terminals [R2A]-[R2C], set "4" or "5" for <F134: Terminal R2 function>. When you want to output the signals from the terminal [FP], set "4" or "5" for <F130: Terminal FP function 1>.

**Reference**

- How to operate the operation panel -> Refer to [3. 1. 1].
- How to switch display mode on the operation panel -> Refer to [3. 1. 2].
- Procedure to change parameter setting -> Refer to [4. 2. 3]
- Details on operation by external signals -> Refer to [Chapter 7].

## 6. 1. 2 Output a signal when reached to a frequency command (output the Acc/Dec completed signal)

<F102: Reach signal detection band>

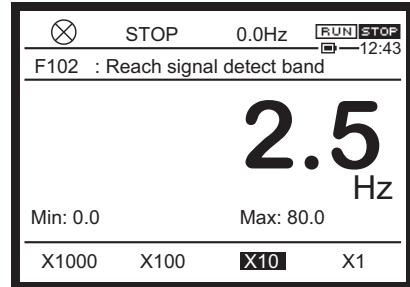

### ■ Function

When the output frequency becomes the frequency command  $\pm$ <F102: Reach signal detection band>, the Acc/Dec completed signal is output from the output terminal.

### ■ Parameter setting

Title	Parameter name	Adjustment range	Unit	Default setting
F102	Reach signal detection band	0.0-FH	Hz	2.5

6

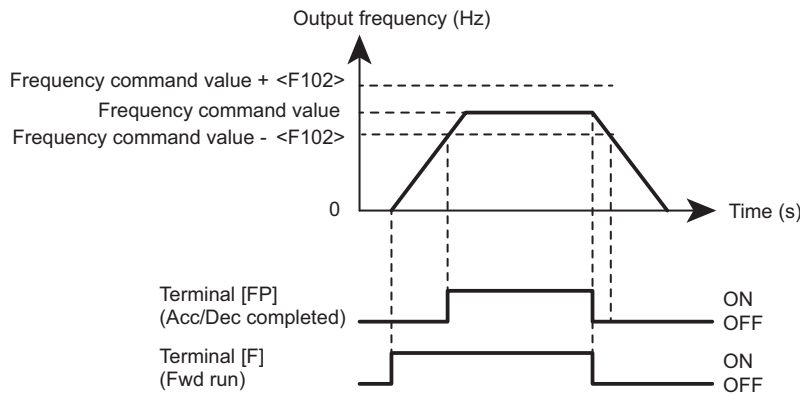

### ■ Output terminal parameter setting

Acc/Dec completed signal is the default setting for output terminal [FP].

Title	Parameter name	Adjustment range	Default setting
F130	Terminal FP function 1	0-255*1	6

\*1 For details on the output terminal functions, refer to [7. 2. 2].

**Memo**

- When you want to output the inversion signal (OFF signal), set "7".
  - The signals can be also output from the other output terminals depending on the parameter setting.
- When you want to output the signals from the [FLA]-[FLB]-[FLC] relay logic output terminals, set at <F132: Terminal FL function>. When you want to output the signals from the terminals [R1A]-[R1C], set at <F133: Terminal R1 function 1>. When you want to output the signals from the terminals [R2A]-[R2C], set at <F134: Terminal R2 function >.
- When the run command (Fwd signal or Rev signal) is OFF, the Acc/Dec completed signal is also OFF.

**Reference**

- How to operate the operation panel -> Refer to [3. 1. 1].
- How to switch display mode on the operation panel -> Refer to [3. 1. 2].
- Procedure to change parameter setting -> Refer to [4. 2. 3].
- Details on operation by external signals -> Refer to [Chapter 7].

### 6. 1. 3 Output a signal when reached to a specified frequency (output the specified frequency attainment signal)

<F101: Reach signal specified frequency>  
 <F102: Reach signal detection band>

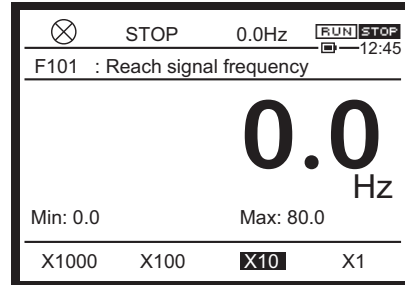

■ **Function**

When the output frequency becomes the frequency that is equal to the value for <F101: Reach signal specified frequency> plus or minus the value for <F102: Reach signal detection band>, the ON signal (specified frequency attainment signal) is output from a specified output terminal.

■ **Parameter setting**

Title	Parameter name	Adjustment range	Unit	Default setting
F101	Reach signal specified frequency	0.0-FH	Hz	0.0
F102	Reach signal detection band	0.0-FH	Hz	2.5

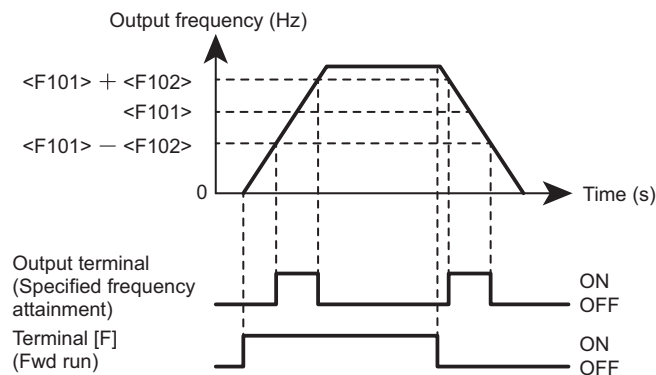

■ **Output terminal parameter setting**

When you want to output the specified frequency attainment signal to the output terminal [FP], set "8" for <F130: Terminal FP function 1>.

When you want to output the signal from the relay logic output terminals [FLA]-[FLB]-[FLC], set <F132: Terminal FL function>. When you want to output the signal from the [R1A]-[R1C] terminals, set <F133: Terminal R1 function 1>. When you want to output the signal from the terminals [R2A]-[R2C] set <F134: Terminal R2 function >.

**Memo**

- When you want to output the inversion signal (OFF signal), set "9".
- When a run command (Fwd signal or Rev signal) is OFF, the specified frequency attainment signal is also OFF.

**Reference**

- How to operate the operation panel -> Refer to [3. 1. 1].
- How to switch display mode on the operation panel -> Refer to [3. 1. 2].
- Procedure to change parameter setting -> Refer to [4. 2. 3].
- Details on operation by external signals -> Refer to [Chapter 7].



## 6.2 Input signals to the control terminals

Various signals are input to the inverter for motor operation.  
For details on the input terminal function, refer to [7. 2. 1].

### 6.2.1 Selecting operation at simultaneous input of Fwd/Rev commands

<F105: Fwd/Rev priority of both close>

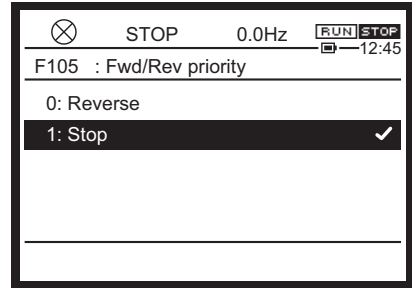

■ **Function**

This parameter selects operation performed (reverse run or deceleration stop) when the Fwd and Rev signals are simultaneously input.

■ **Parameter setting**

Title	Parameter name	Adjustment range	Default setting
F105	Fwd/Rev priority of both close	0: Reverse 1: Stop	1

■ **Difference between the settings**

**0: Reverse**

When the Fwd and Rev signals are simultaneously input, reverse run is performed.

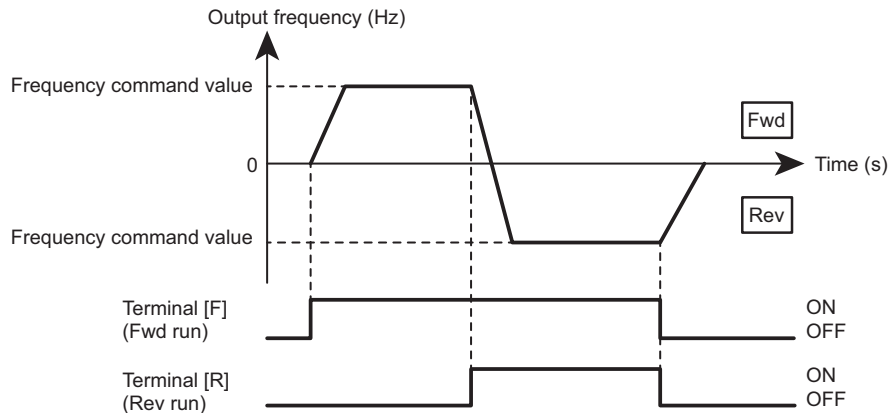

**1: Stop**

When the Fwd and Rev signals are simultaneously input, deceleration stop is performed.

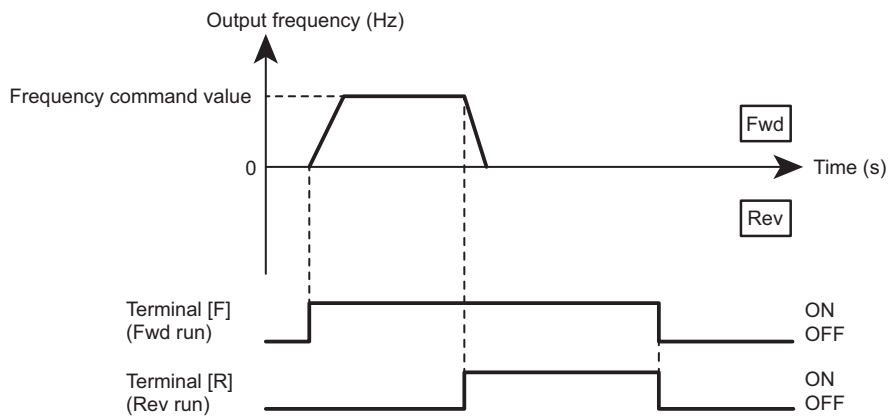

**6**

**Reference**

- How to operate the operation panel -> Refer to [3. 1. 1].
- How to switch display mode on the operation panel -> Refer to [3. 1. 2].
- Procedure to change parameter setting -> Refer to [4. 2. 3].
- Details on operation by external signals -> Refer to [Chapter 7].

## 6. 2. 2 Selecting input voltage of the terminal [RX]

<F107: Terminal RX input voltage select>

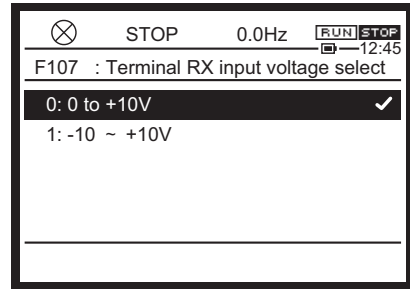

### ■ Function

This parameter selects the input voltage of the terminal [RX].

### ■ Parameter setting

Title	Parameter name	Adjustment range	Default setting
F107	Terminal RX input voltage select	0: 0 to +10 V 1: -10 to +10 V	0

6

### ■ Difference between the settings

#### 0: 0 to +10 V

Input 0 to 10 Vdc between the terminals [RX]-[CC].  
The resolution is 1/1000 at the maximum at 0 to 10 Vdc.

#### 1: -10 to +10 V

Input -10 to +10 Vdc between the terminals [RX]-[CC].  
The resolution is 1/2000 at the maximum at -10 to +10 Vdc.

### Reference

- How to operate the operation panel -> Refer to [3. 1. 1].
- How to switch display mode on the operation panel -> Refer to [3. 1. 2].
- Procedure to change parameter setting -> Refer to [4. 2. 3]
- Details on operation by external signals -> Refer to [Chapter 7].

### 6. 2. 3 Selecting input signal of the terminal [RR]

<F108: Terminal RR input select>

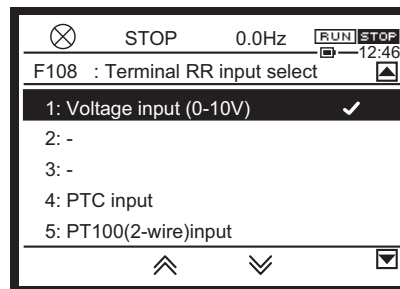

■ **Function**

This parameter selects the input signal of the terminal [RR].

■ **Parameter setting**

Title	Parameter name	Adjustment range	Default setting
F108	Terminal RR input select	1: Voltage input (0-10 V) 2, 3: - 4: PTC input 5: PT100 (2-wire) input 6: - 7: PT1000 (2-wire) input 8: - 9: KTY84 input	1

6

**Reference**

- How to operate the operation panel -> Refer to [3. 1. 1].
- How to switch display mode on the operation panel -> Refer to [3. 1. 2].
- Procedure to change parameter setting -> Refer to [4. 2. 3]

## 6. 2. 4 Selecting input signals of the optional terminals [AI4] and [AI5]

<F148: Terminal AI4 input select>

<F149: Terminal AI5 input select>

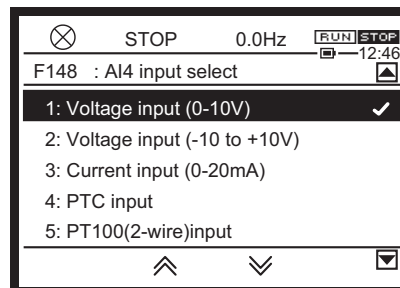

### ■ Function

These parameters select an input signal for the optional terminals [AI4] and [AI5].

### ■ Parameter setting

Title	Parameter name	Adjustment range	Default setting
F148	Terminal AI4 input select	1: Voltage input (0-10 V) 2: Voltage input (-10 to +10 V) 3: Current input (0-20 mA) 4: PTC input 5: PT100 (2-wire) input	1
F149	Terminal AI5 input select	6: PT100 (3-wire) input 7: PT1000 (2-wire) input 8: PT1000 (3-wire) input 9: KTY84 input	1

6

### Reference

- How to operate the operation panel -> Refer to [3. 1. 1].
- How to switch display mode on the operation panel -> Refer to [3. 1. 2].
- Procedure to change parameter setting -> Refer to [4. 2. 3].

## 6.3 Selecting terminal functions

### 6.3.1 Always enabling the input terminal functions (always ON)

<F110: Always active function 1>

<F127: Always active function 2>

<F128: Always active function 3>

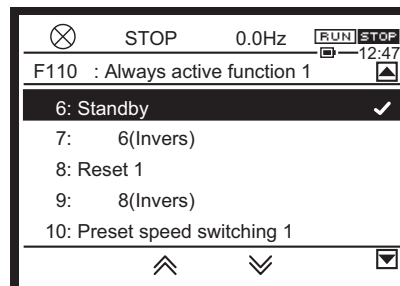

#### ■ Function

These parameters select an input terminal function to be always enabled (always ON). You can set three points.

#### ■ Parameter setting

Title	Parameter name	Adjustment range	Default setting
F110	Always active function 1	0-177*1	6
F127	Always active function 2		0
F128	Always active function 3		0

\*1 For details on the input terminal functions, refer to [7. 2. 1].

Memo

- Coast stop is a stop pattern where the inverter output is turned OFF, and the motor rotation stops spontaneously.  
The deceleration stop is performed by default setting (the frequency is decreased to 0 Hz by the inverter deceleration time).
- When "ST" (standby) is turned OFF, the motor performs coast stop.
- "ST"(standby)is always ON by default setting. Therefore, change the setting as shown below:
  - <F110: Always active function 1> = "0: No function"
  - Assign "6: ST" (standby) to an unused input terminal.
- When the terminal where "ST" (standby) is assigned is turned OFF, coast stop will be performed.

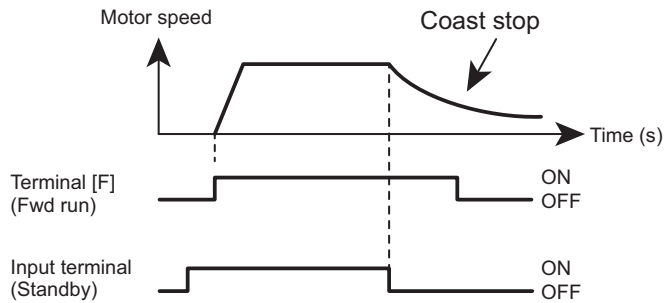

Reference

- How to operate the operation panel -> Refer to [3. 1. 1].
- How to switch display mode on the operation panel -> Refer to [3. 1. 2].
- Procedure to change parameter setting -> Refer to [4. 2. 3].
- Details on operation by external signals -> Refer to [Chapter 7].

## 6. 3. 2 Changing the input terminal functions

<F111: Terminal F function 1>  
<F112: Terminal R function 1>  
<F113: Terminal RES function 1>  
<F114: Terminal S1 function 1>  
<F115: Terminal S2 function>  
<F116: Terminal S3 function>  
<F117: Terminal S4 function>  
<F118: Terminal S5 function>  
<F119: Terminal DI11 function>  
<F120: Terminal DI12 function>  
<F121: Terminal DI13 function>  
<F122: Terminal DI14 function>  
<F123: Terminal DI15 function>  
<F124: Terminal DI16 function>  
<F140: Terminal F response time>  
<F141: Terminal R response time>  
<F142: Terminal RES response time>  
<F143: Terminal S1 response time>  
<F144: Terminal S2-S5 response time>  
<F145: Terminal DI11-DI16 response time>  
<F146: Terminal S4 input select>  
<F147: Terminal S5 input select>  
<F151: Terminal F function 2>  
<F152: Terminal R function 2>  
<F153: Terminal RES function 2>  
<F154: Terminal S1 function 2>  
<F155: Terminal F function 3>  
<F156: Terminal R function 3>  
<F157: Terminal RES function 3>  
<F158: Terminal S1 function 3>

For details on the input terminal functions, refer to [7. 2. 1].



### **6. 3. 3    Changing the output terminal functions**

<F130: Terminal FP function 1>  
<F132: Terminal FL function >  
<F133: Terminal R1 function 1>  
<F134: Terminal R2 function >  
<F135: Terminal R1 delay time>  
<F136: Terminal R2 delay time>  
<F137: Terminal FP function 2>  
<F138: Terminal R1 function 2>  
<F139: Terminal FP, R1 logic selct>  
<F159: Terminal DQ11 function>  
<F160: Terminal DQ12 function>  
<F161: Terminal R4 function>  
<F162: Terminal R5 function>  
<F163: Terminal R6 function>

For details on the output terminal functions, refer to [7. 2. 2].

## 6. 4 Switching two to four types of motor characteristics

- <F170: Base frequency 2>
- <F171: Base frequency voltage 2>
- <F172: Manual torque boost 2>
- <F174: Base frequency 3>
- <F175: Base frequency voltage 3>
- <F176: Manual torque boost 3>
- <F178: Base frequency 4>
- <F179: Base frequency voltage 4>
- <F180: Manual torque boost 4>
- <F182: Motor overload protection current 2>
- <F183: Motor overload protection current 3>
- <F184: Motor overload protection current 4>

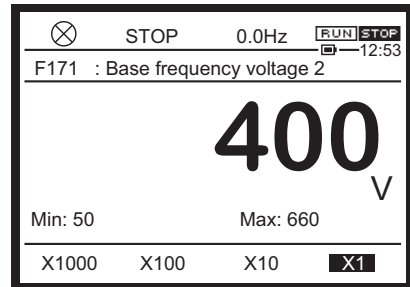
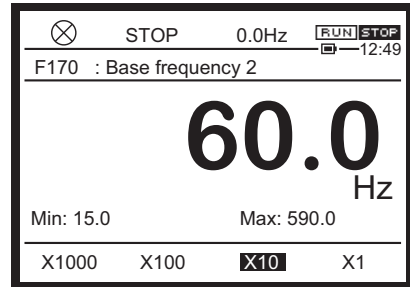

6

### ■ Function

These parameters are used for setting when you want to switch up to four types of motors for an inverter, or when you want to switch the motor V/f characteristics (four types) according to the purpose or operation method.

V/f1 to V/f4 are switched by the input terminal signals.

### Memo

- <Pt: V/f Pattern> is valid only for V/f1.
- When V/f2 to V/f4 are selected, V/f constant control is applied regardless of the setting of <Pt>.
- Do not switch the motors when <Pt: V/f Pattern> is set to "7" or "8".
- For the parameters that are selected when V/f1 to V/f4 are switched, refer to the following table.

### ■ Parameter setting

Title	Parameter name	Adjustment range	Unit	Default setting
F170	Base frequency 2	15.0-590.0	Hz	50.0/60.0 *1
F171	Base frequency voltage 2	240V class: 50-330V 480V class: 50-660V	V	*1
F172	Manual torque boost 2	0.00-30.00	%	*2
F174	Base frequency 3	15.0 - 590.0	Hz	50.0/60.0 *1
F175	Base frequency voltage 3	240V class: 50-330V 480V class: 50-660V	V	*1

Title	Parameter name	Adjustment range	Unit	Default setting
F176	Manual torque boost 3	0.00-30.00	%	*2
F178	Base frequency 4	15.0 - 590.0	Hz	50.0/60.0 *1
F179	Base frequency voltage 4	240V class: 50-330V 480V class: 50-660V	V	*1
F180	Manual torque boost 4	0.00-30.00	%	*2
F182	Motor overload protection current 2	Depending on capacity*2	A*2	*2
F183	Motor overload protection current 3	Depending on capacity*2	A*2	*2
F184	Motor overload protection current 4	Depending on capacity*2	A*2	*2

\*1 Depending on the setup menu. For details, refer to [5. 3. 10], [11. 10].

\*2 Depending on capacity. For details, refer to [11. 6].

■ Switch terminal setting

V/f1 to V/f4 switching functions are not assigned to the input terminals by default setting. Thus, assign them to unused input terminals.

Example: When V/f switching 1 function is assigned to the terminal [S1], and V/f switching 2 function to the terminal [S2].

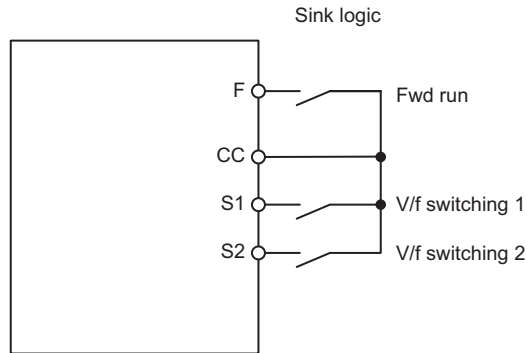

Input terminal		V/f	Parameters selected	Output terminal (function number)	
S1-CC	S2-CC			No.186	No.188
OFF	OFF	1	Base frequency 1: <vL> Base frequency voltage 1: <vLv> Manual torque boost 1: <vb> Motor overload protection current 1: <tHrA>	OFF	OFF
ON	OFF	2	Base frequency 2: <F170> Base frequency voltage 2: <F171> Manual torque boost 2: <F172> Motor overload protection current 2: <F182>	ON	OFF

Input terminal		V/f	Parameters selected	Output terminal (function number)	
S1-CC	S2-CC			No.186	No.188
OFF	ON	3	Base frequency 3: <F174> Base frequency voltage 3: <F175> Manual torque boost 3: <F176> Motor overload protection current 3: <F183>	OFF	ON
ON	ON	4	Base frequency 4: <F178> Base frequency voltage 4: <F179> Manual torque boost 4: <F180> Motor overload protection current 4: <F184>	ON	ON

- Be sure to perform V/f switching in the stop state. Switching is impossible during run. It takes 0.1 second before switching. Therefore, be sure to wait 0.1 second or more after inputting a switching signal, and then start operation.
- When you want to use the vector control and V/f 5-point setting, select V/f1. When V/f2 to V/f4 are selected, V/f constant is obtained, and thus making the vector control impossible.
- When you use an input terminal where a variety of functions can be assigned, you can link the switching of torque limit or acceleration/deceleration time to V/f switching.

For operation panel run, you can also set the acceleration/deceleration time at <F504: Panel Acc/Dec select>. For details, refer to [6. 27. 2].

6

Reference

- How to operate the operation panel -> Refer to [3. 1. 1].
- How to switch display mode on the operation panel -> Refer to [3. 1. 2].
- Procedure to change parameter setting -> Refer to [4. 2. 3].
- Details on operation by external signals -> Refer to [Chapter 7].

## 6.5 V/f 5-point setting

<F190: V/f 5-point VF1 frequency>

<F191: V/f 5-point VF1 voltage>

<F192: V/f 5-point VF2 frequency>

<F193: V/f 5-point VF2 voltage>

<F194: V/f 5-point VF3 frequency>

<F195: V/f 5-point VF3 voltage>

<F196: V/f 5-point VF4 frequency>

<F197: V/f 5-point VF4 voltage>

<F198: V/f 5-point VF5 frequency>

<F199: V/f 5-point VF5 voltage>

Refer to [5. 3. 4].

## 6. 6 Setting the frequency commands

You can set the frequency commands in various methods. Select a frequency command setting method according to operation. You can also switch the frequency commands using signals to the terminals.

### 6. 6. 1 Switching two types of frequency commands

- <F200: Frequency command priority select>
- <FM0d: Frequency command select 1>
- <F207: Frequency command select 2>
- <F208: Frequency command switching frequency>

Refer to [5. 4. 1].

### 6. 6. 2 Setting frequency command characteristics by analog signals

6

- <F107: Terminal RX input voltage select>
- <F108: Terminal RR input select>
- <F148: Terminal AI4 input select>
- <F149: Terminal AI5 input select>
- <F201: RR point 1 input value>
- <F202: RR point 1 frequency>
- <F203: RR point 2 input value>
- <F204: RR point 2 frequency>
- <F205: RR point 1 rate>
- <F206: RR point 2 rate>
- <F209: Analog input filter>
- <F210: RX point 1 input value>
- <F211: RX point 1 frequency>
- <F212: RX point 2 input value>
- <F213: RX point 2 frequency>
- <F214: RX point 1 rate>
- <F215: RX point 2 rate>
- <F216: II point 1 input value>
- <F217: II point 1 frequency>
- <F218: II point 2 input value>
- <F219: II point 2 frequency>
- <F220: II point 1 rate>
- <F221: II point 2 rate>
- <F222: AI4 point 1 input value>
- <F223: AI4 point 1 frequency>
- <F224: AI4 point 2 input value>
- <F225: AI4 point 2 frequency>
- <F226: AI4 point 1 rate>
- <F227: AI4 point 2 rate>
- <F228: AI5 point 1 input value>

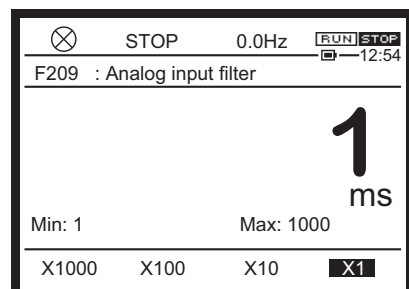
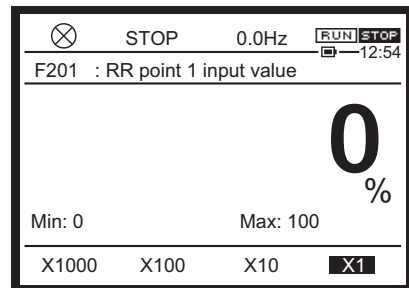

- <F229: AI5 point 1 frequency>
- <F230: AI5 point 2 input value>
- <F231: AI5 point 2 frequency>
- <F810: Communication frequency point select>
- <F811: Communication point 1 input value>
- <F812: Communication point 1 frequency>
- <F813: Communication point 2 input value>
- <F814: Communication point 2 frequency>

■ **Function**

These parameters set the output frequencies for the frequency commands of the analog signals. You can use the following terminals. The terminals [AI4] and [AI5] are optional.

- Voltage input (0 to 10 V) : terminals [RR], [RX], [AI4], and [AI5]
- Voltage input (-10 to +10 V) : terminals [RX], [AI4], and [AI5]
- Current input (4 to 20 mA) : terminals [II], [AI4], and [AI5]

■ **Parameter setting**

Title	Parameter name	Adjustment range	Unit	Default setting
F107	Terminal RX input voltage select	0: 0 to +10 V 1: -10 to +10 V	-	0
F108	Terminal RR input select	1: Voltage input (0-10 V) 2: - 3: - 4: PTC input 5: PT100 (2-wire) input 6: - 7: PT1000 (2-wire) input 8: - 9: KTY84 input	-	1
F148	Terminal AI4 input select	1: Voltage input (0-10 V) 2: Voltage input (-10 to +10 V) 3: Current input (0-20 mA) 4: PTC input 5: PT100 (2-wire) input 6: PT100 (3-wire) input 7: PT1000 (2-wire) input 8: PT1000 (3-wire) input 9: KTY84 input	-	1
F149	Terminal AI5 input select			1
F201	RR point 1 input value	0-100	%	0
F202	RR point 1 frequency	0.0-590.0	Hz	0.0
F203	RR point 2 input value	0-100	%	100
F204	RR point 2 frequency	0.0-590.0	Hz	50.0/60.0 *1
F205	RR point 1 rate	0-250	%	0
F206	RR point 2 rate	0-250	%	100
F209	Analog input filter	1: Disabled 2-1000	ms	1

Title	Parameter name	Adjustment range	Unit	Default setting
F210	RX point 1 input value	-100 to +100	%	0
F211	RX point 1 frequency	0.0-590.0	Hz	0.0
F212	RX point 2 input value	-100 to +100	%	100
F213	RX point 2 frequency	0.0-590.0	Hz	50.0/60.0 *1
F214	RX point 1 rate	-250 to +250	%	0
F215	RX point 2 rate	-250 to +250	%	100
F216	II point 1 input value	0-100	%	0
F217	II point 1 frequency	0.0-590.0	Hz	0.0
F218	II point 2 input value	0-100	%	100
F219	II point 2 frequency	0.0-590.0	Hz	50.0/60.0 *1
F220	II point 1 rate	0-250	%	0
F221	II point 2 rate	0-250	%	100
F222	AI4 point 1 input value	-100 to +100	%	0
F223	AI4 point 1 frequency	0.0-590.0	Hz	0.0
F224	AI4 point 2 input value	-100 to +100	%	100
F225	AI4 point 2 frequency	0.0-590.0	Hz	50.0/60.0 *1
F226	AI4 point 1 rate	-250 to +250	%	0
F227	AI4 point 2 rate	-250 to +250	%	100
F228	AI5 point 1 input value	-100 to +100	%	0
F229	AI5 point 1 frequency	0.0-590.0	Hz	0.0
F230	AI5 point 2 input value	-100 to +100	%	100
F231	AI5 point 2 frequency	0.0-590.0	Hz	50.0/60.0 *1
F810	Communication frequency point select	0: Disabled 1: RS485 (1) 2: RS485 (2) 3: Communication option 4: Embedded Ethernet		0
F811	Communication point 1 input value	0-100	%	0
F812	Communication point 1 frequency	0.0-FH	Hz	0.0
F813	Communication point 2 input value	0-100	%	100
F814	Communication point 2 frequency	0.0-FH	Hz	50.0/60.0 *1

\*1 Depending on the setup menu. Refer to [11. 10].



■ **Setting method**

Set a frequency command for an analog input amount at two points.

For the corresponding parameters of each terminal and the setting method, refer to the following.

As default setting, the range between the minimum and maximum input amounts is set to 0 to 50.0/60.0 Hz for main analog signal of the terminals. For example, the terminal [RR] is set to 0 to 50.0/60.0 Hz at 0-10 V.

- For the terminal [RX], select the voltage for <F107: Terminal RX input voltage select>.
- For the terminal [AI4], select the analog signal for <F148: Terminal AI4 input select>. For the terminal [AI5], select the analog signal for <F149: Terminal AI5 input select>. The terminals [AI4] and [AI5] are optional.
- If noise disturbs stable operation, increase the value for <F209: Analog input filter>. Doing so eliminates the noise of the frequency setting circuit.
- Do not set the same value for point 1 and point 2. Failure to do so displays "Err1".

For details on the analog signal setting, refer to [7. 3].

**1) For setting the voltage input of 0-10 V (terminals [RR]), refer to the following figure.**

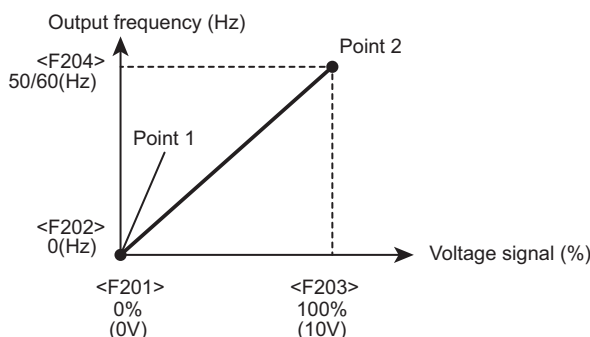

6

**2) For setting current input of 4-20 mA (terminal [II]), refer to the following figure.**

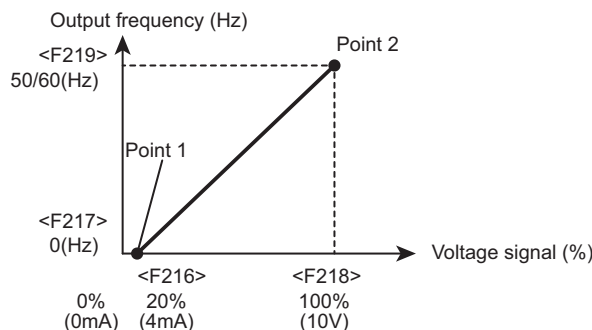

3) For setting voltage input of -10 to +10 V (terminal [RX]), refer to the following figure.

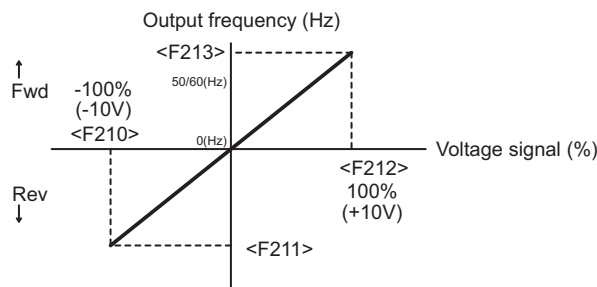

<F107: Terminal RX input voltage select> = "-10 to +10 V"

6

Memo

- When you want to fine adjust the frequency command characteristics, adjust the bias and gain of each input terminal at <F470: RR input bias>-<F479: AI5 input gain>. For details, refer to [6. 6. 3].
- When you want to set an analog signal for a frequency command, set at <FMOD: Frequency command select 1> (or <F207: Frequency command select 2>).
  - 1: Terminal RR
  - 2: Terminal RX
  - 3: Terminal II
  - 4: Terminal AI4 (option)
  - 5: Terminal AI5 (option)

Reference

- How to operate the operation panel -> Refer to [3. 1. 1].
- How to switch display mode on the operation panel -> Refer to [3. 1. 2].
- Procedure to change parameter setting -> Refer to [4. 2. 3].
- Details on operation by external signals -> Refer to [Chapter 7].

### 6. 6. 3 Fine adjusting the analog frequency commands

- <F470: RR input bias>
- <F471: RR input gain>
- <F472: RX input bias>
- <F473: RX input gain>
- <F474: II input bias>
- <F475: II input gain>
- <F476: AI4 input bias>
- <F477: AI4 input gain>
- <F478: AI5 input bias>
- <F479: AI5 input gain>

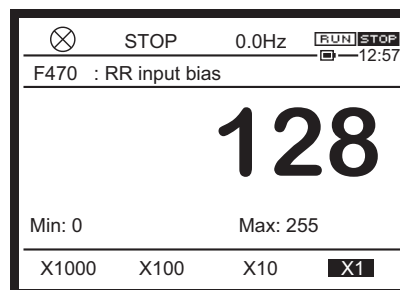

■ Function

These parameters fine adjust the characteristics set in [6. 6. 2] "Setting frequency command characteristics by analog signals".

The allowance is zero setting on default setting.

■ **Parameter setting**

Title	Parameter name	Adjustment range	Unit	Default setting
F470	RR input bias	0-255	-	128
F471	RR input gain	0-255	-	128
F472	RX input bias	0-255	-	128
F473	RX input gain	0-255	-	128
F474	II input bias	0-255	-	128
F475	II input gain	0-255	-	128
F476	AI4 input bias	0-255	-	128
F477	AI4 input gain	0-255	-	128
F478	AI5 input bias	0-255	-	128
F479	AI5 input gain	0-255	-	128

■ **Adjustment method**

For the frequency commands to be input to the analog terminals and the output frequency characteristics, refer to the following figure.

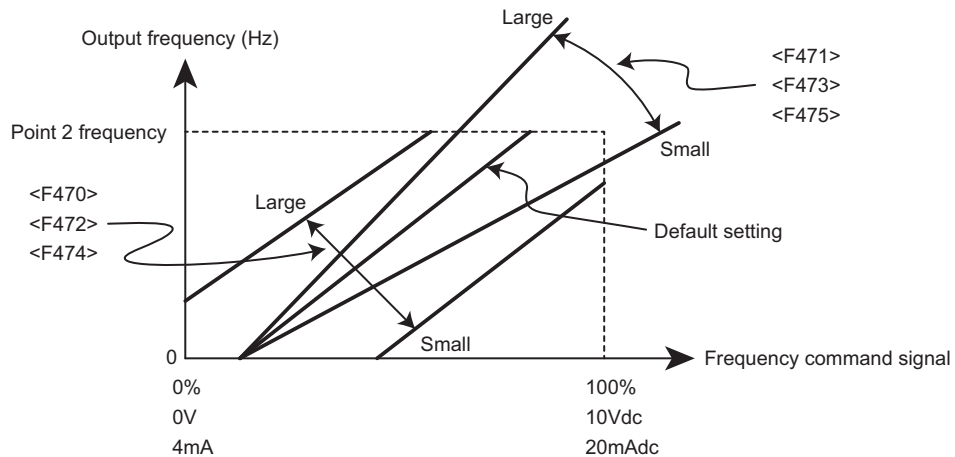

**Analog input terminal bias adjustment (<F470>, <F472>, <F474>, <F476>, and <F478>)**

To avoid the influence of noise, there is a tolerance for the minimum input amount so that the inverter starts output after some voltage/current is applied to the analog input terminal by default setting.

To decrease this tolerance value, increase the bias value for a corresponding terminal.

However, if the set value is too large, frequency may be output even when the frequency command is set to 0 (zero).

**Analog input terminal gain adjustment (<F471>, <F473>, <F475>, <F477>, and <F479>)**

The set maximum frequency is output before voltage/current reach the maximum value to avoid trouble such as voltage drop by default setting.

When you want to output the set maximum frequency at the maximum voltage and current values, decrease the gain value for a corresponding terminal.  
However, if the set value is too small, the maximum frequency may not be output even when voltage and current reach the maximum values.

**Reference**

- How to operate the operation panel -> Refer to [3. 1. 1].
- How to switch display mode on the operation panel -> Refer to [3. 1. 2].
- Procedure to change parameter setting -> Refer to [4. 2. 3].
- Details on operation by external signals -> Refer to [Chapter 7].

## 6. 6. 4 Input the frequency commands by pulse trains

- <F146: Terminal S4 input select>
- <F147: Terminal S5 input select>
- <F234: Pulse train input point 1 input value>
- <F235: Pulse train input point 1 frequency>
- <F236: Pulse train input point 2 input value>
- <F237: Pulse train input point 2 frequency>
- <F376: PG phases number select>
- <F378: Pulse train input pulses number>
- <F679: Pulse train input filter>

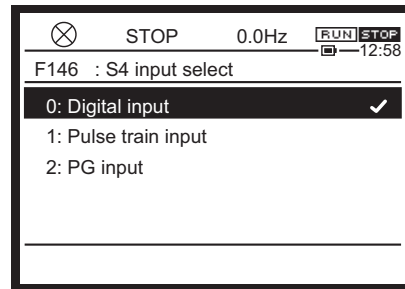

### ■ Function

These parameters set the frequency command characteristics by pulse train input.

You can use the terminals [S4] and [S5].

When you want to use pulse train input, set <FM0d: Frequency command select 1> (or <F207: Frequency command select 2>) to "16: Pulse train".

### ■ Parameter setting

Title	Parameter name	Adjustment range	Unit	Default setting
F146	Terminal S4 input select	0: Digital input 1: Pulse train input 2: PG input		0
F147	Terminal S5 input select	0: Digital input 1: Pulse train input 2: PG input		0
F378	Pulse train input pulses number	1-9999	pps	1000
F679	Pulse train input filter	1-1000	ms	1
F234	Pulse train input point 1 input value	0 - 100	%	0
F235	Pulse train input point 1 frequency	0.0 - 590.0	Hz	0.0
F236	Pulse train input point 2 input value	0 - 100	%	100
F237	Pulse train input point 2 frequency	0.0 - 590.0	Hz	50.0/60.0 *1
F376	PG phases number select	0: PTI (Command) - PTI (FB) 1: PTI (Command) - Digital option (FB) 2 - 5: - 6: Digital option (Command) - Non FB 7 - 9: - 10: PTI (Command) - PTI (FB inversion) 11: PTI (Command) - Digital option (FB inversion) 12 - 15: - 16: Digital option (Command inversion) - Non FB		0

\*1 Depending on the setup menu. For details, refer to [5. 3. 10], [11. 10].

■ **Guideline for the setting**

When you want to use the terminal [S4], set <F146: Terminal S4 input select> to "1: Pulse train input". When you want to use the terminal [S5], set <F147: Terminal S5 input select> to "1: Pulse train input".

Set the number of pulses per 1 Hz of output frequency at <F378; Pulse train input pulses number>.

The minimum number of pulses that can be input to the terminals [S4] and [S5] is 10 pps, and the maximum number of pulses 30 kpps. The duty is 50 ±10%.

The maximum frequency that can be output is 200 Hz.

■ **Setting example**

<F378> setting value	Input signal	Output frequency
25 (pps)	25 (pps)	1.0 (Hz)
	100 (pps)	4.0 (Hz)
	2k (pps)	80.0 (Hz)
50 (pps)	50 (pps)	1.0 (Hz)
	100 (pps)	2.0 (Hz)
	2k (pps)	40.0 (Hz)

6

**Reference**

- How to operate the operation panel -> Refer to [3. 1. 1].
- How to switch display mode on the operation panel -> Refer to [3. 1. 2].
- Procedure to change parameter setting -> Refer to [4. 2. 3].
- Details on operation by external signals -> Refer to [Chapter 7].
- For use as PG feedback, refer to "Digital Encoder Instruction manual" (E6582148).
- Pulse train must be input after F146 or F147 is set to 1.
- If pulse train is input when F146 or F147 is set to 0 (default value), preset speed works.

## 6. 6. 5 Changing frequency by the terminal UP and DOWN signal

- <F264: Terminal Up response time>
- <F265: Terminal Up frequency step>
- <F266: Terminal Down response time>
- <F267: Terminal Down frequency step>
- <F268: Initial Up/Down frequency>
- <F269: Up/Down frequency rewrite>

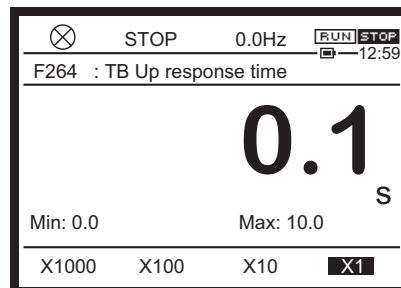

### ■ Function

These parameters are the frequency commands that input the logic signals to the two input terminals for the UP and DOWN signals. You can input a logic signal either as a continuous signal or as a pulse signal.

Set <FM0d: Frequency command select 1>= "15".

### ■ Parameter setting

Title	Parameter name	Adjustment range	Unit	Default setting
F264	Terminal Up response time	0.0-10.0	s	0.1
F265	Terminal Up frequency step	0.0-FH	Hz	0.1
F266	Terminal Down response time	0.0-10.0	s	0.1
F267	Terminal Down frequency step	0.0-FH	Hz	0.1
F268	Initial Up/Down frequency	LL-UL	Hz	0.0
F269	Up/Down frequency rewrite	0: F268 is not changed. 1: F268 is changed after power off.		1

### ■ Input terminal parameter setting

Three input terminals are used.

Two of the three input terminals are used for the UP and DOWN signals. The other input terminal is used for the signal that clears the set frequency command.

Input terminal function		ON	OFF
88	Terminal Up frequency	Frequency setting increase	-
90	Terminal Down frequency	Frequency setting decrease	-
92	Terminal Up, Down frequency clear	OFF → ON: Input terminal up/down frequency command clear	<F268> setting

**When the signals are simultaneously input**

- When the clear signal, and an UP or a DOWN signal are simultaneously input, the clear signal takes priority.
- When an UP signal and a DOWN signal are simultaneously input, the frequency changes according to the up rate and the down rate.

**Memo**

- The next number of each function number ("89", "91", or "93") is an inversion signal.
- When <F702: Free unit multiplication factor>="1.00", you can make setting in steps of 0.01 Hz.

■ **Setting example 1: Increase or decrease by the continuous signals**

When you want to increase or decrease the output frequency in proportion to the input time of the UP and DOWN signals, set the parameters as shown below:

UP/DOWN frequency increase inclination=Setting time for <F265>/<F264>

UP/DOWN frequency decrease inclination=Setting time for <F267>/<F266>

When you want to increase or decrease the output frequency almost in synchronization with the increase or decrease in the UP/DOWN frequency command, set the parameters as shown below:

<F264>=<F266> = "0.1"

<FH>/<ACC> ≥ (Setting time for <F265>/<F264>)

<FH>/<dEC> ≥ (Setting time for <F267>/<F266>)

6

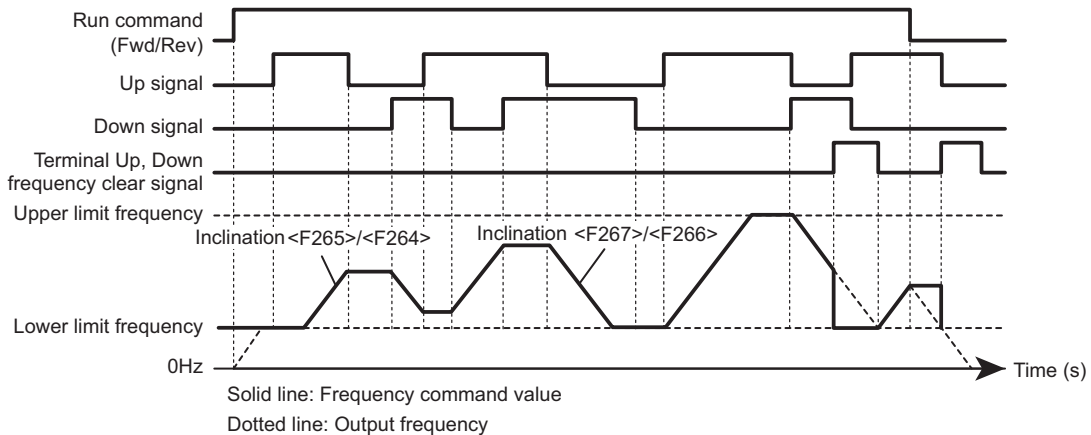

■ **Setting example 2: Increase or decrease by the pulse signals**

When you want to increase or decrease the frequency per pulse stepwise, set the parameters as shown below:

<F264>, <F266> ≤ Pulse ON time

<F265>, <F267> = Frequency that increases or decreases per pulse

However, no response is obtained to the pulse below the time set for <F264> and <F266>. Set 12 ms or more for the clear signal.



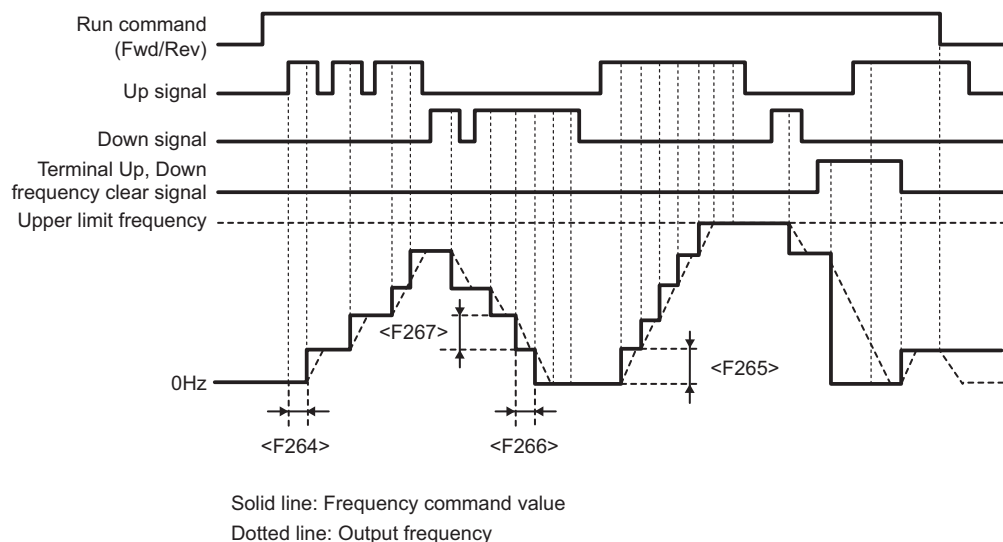

■ Initial UP/DOWN frequency setting method

When you want to set a specified frequency other than 0.0 Hz at first after power on, set <F268: Initial Up/Down frequency>.

Also, set <F269: Up/Down frequency rewrite> to "0: F268 is not changed".

Save the frequency before power off. When you want to start at the saved frequency the next time the power is turned ON, set <F269: Up/Down frequency rewrite> to "1: F268 is changed after power off."

Keep in mind that <F268: Initial Up/Down frequency> is changed every time the power is turned OFF.

The adjustment range of <F268: Initial Up/Down frequency> is <LL: Lower limit frequency> to <FH: Maximum frequency>. When Terminal Up, Down frequency clear (function number: "92" or "93") is input, the lower limit frequency is set for the frequency command.

Reference

- How to operate the operation panel -> Refer to [3. 1. 1].
- How to switch display mode on the operation panel -> Refer to [3. 1. 2].
- Procedure to change parameter setting -> Refer to [4. 2. 3].
- Details on operation by external signals -> Refer to [Chapter 7].

## 6.7 Setting the start and end frequencies

### 6.7.1 Setting the starting frequency and the end frequency

<F240: Start frequency>  
<F243: End frequency>

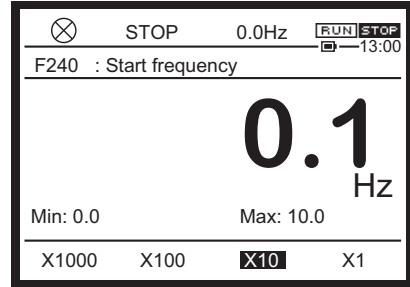

#### ■ Function

The frequency set for <F240: Start frequency> is instantly output at startup.  
This parameter is used when the delayed response of starting torque caused by the acceleration/ deceleration time affects the frequency.  
When the output frequency is decreased to the frequency set for <F243: End frequency>, the frequency instantly becomes 0 Hz when stopping.

#### ■ Parameter setting

Title	Parameter name	Adjustment range	Unit	Default setting
F240	Start frequency	0.0-10.0	Hz	0.1
F243	End frequency	0.0-30.0	Hz	0.0

#### ■ Setting method

Use the parameters when the delayed response of starting torque caused by the acceleration/ deceleration time affects the frequency. For the setting values, 0.1-3.0 Hz (5 Hz or less) is recommended. Overcurrent can be reduced by setting the value to the motor rated slippage or less. Set the values so that <F240: Start frequency> is higher than <F243: End frequency>.  
When <F240> is lower than <F243>, no operation is performed by any frequency command lower than <F243>.

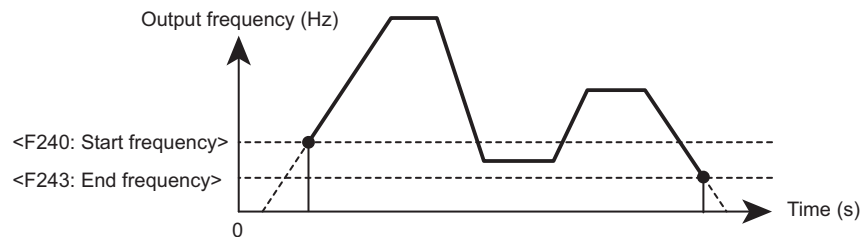

6

Reference

- How to operate the operation panel -> Refer to [3. 1. 1].
- How to switch display mode on the operation panel -> Refer to [3. 1. 2].
- Procedure to change parameter setting -> Refer to [4. 2. 3].

## 6. 7. 2 Run/stop with a frequency command

<F241: Run frequency>

<F242: Run frequency hysteresis>

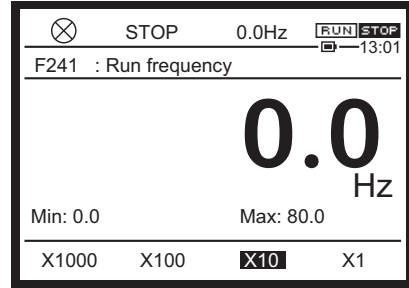

### ■ Function

You can run/stop the motor with only a frequency command when a run command remains ON. When the frequency command reaches the set frequency value, the inverter will start to run. When it becomes below the set value, the inverter will stop.

6

### ■ Parameter setting

Title	Parameter name	Adjustment range	Unit	Default setting
F241	Run frequency	0.0 - FH	Hz	0.0
F242	Run frequency hysteresis	0.0 - FH	Hz	0.0

### ■ Setting method

When the frequency command reaches the setting value of <F241: Run frequency>, the inverter will start to run. When the command becomes below the setting value, the inverter will stop.

To prevent the inverter from repeatedly running/stopping around the frequency set with <F241: Run frequency>, use <F242: Run frequency hysteresis> to provide hysteresis.

Set the parameter, referring to the following figure.

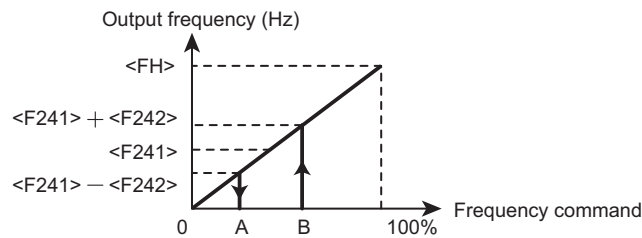

Reference

- How to operate the operation panel -> Refer to [3. 1. 1].
- How to switch display mode on the operation panel -> Refer to [3. 1. 2].
- Procedure to change parameter setting -> Refer to [4. 2. 3]

### 6. 7. 3 Setting a frequency command to 0 Hz securely

<F244: 0 Hz dead band>

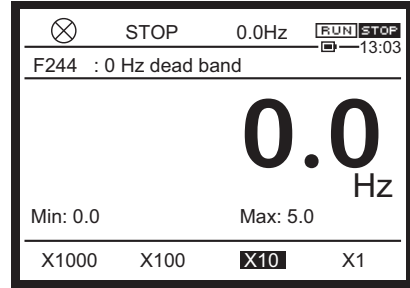

6

■ Function

Set the frequency command to 0 Hz when it is under the setting value of <F244: 0 Hz dead band>. This function is used to securely set the frequency command to 0 Hz in the following case: although an analog signal is set to 0 Hz in order to use the vector control with a sensor to fix the motor shaft, it does not become 0 Hz due to a drift or offset.

■ Parameter setting

Title	Parameter name	Adjustment range	Unit	Default setting
F244	0 Hz dead band	0.0 - 5.0	Hz	0.0

Output value after processing frequency command dead band

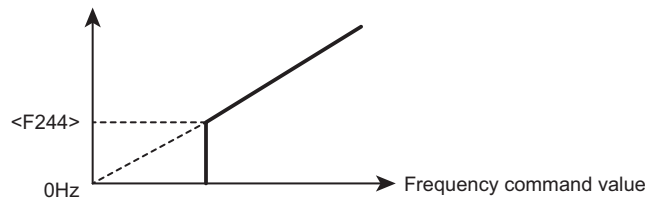

Memo

- This function is invalid for a preset speed frequency command.
- It is valid for frequency commands which are prioritized in <FM0d: Frequency command selection 1>, <F207: Frequency command selection 2>, and communications.
- For the override function, values are added or multiplied for frequencies with this function enabled.

**Reference**

- How to operate the operation panel -> Refer to [3. 1. 1].
- How to switch display mode on the operation panel -> Refer to [3. 1. 2].
- Procedure to change parameter setting -> Refer to [4. 2. 3]

## 6. 8 DC braking

### 6. 8. 1 Obtaining large torque with DC braking

<F249: DC braking carrier frequency>

<F250: DC braking frequency>

<F251: DC braking amount>

<F252: DC braking time>

<F253: Fwd/Rev DC braking priority>

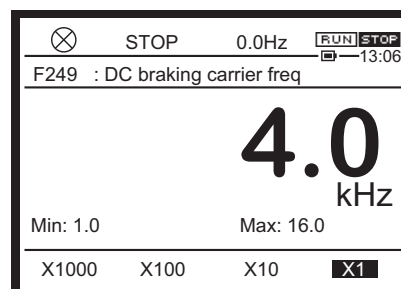

#### ■ Function

Apply direct current to the motor to obtain braking torque. This will stop the motor. It is used, for example, to securely decelerate and stop the motor.

You can set the amount and time of direct current applied to the motor and the start frequency.

#### ■ Parameter setting

Title	Parameter name	Adjustment range	Unit	Default setting
F249	DC braking carrier frequency	1.0 - 16.0	kHz	*1
F250	DC braking frequency	0.0 - FH	Hz	0.0
F251	DC braking current	0 - 100	%	50
F252	DC braking time	0.0 - 25.5	s	1.0
F253	Fwd/Rev DC braking priority	0: Disabled 1: Enabled		0

\*1 Depending on capacity. For details, refer to [11. 6].

- The inverter has high sensitivity for overload protection when DC braking is in progress. It may automatically adjust the DC braking amount to prevent a trip.



Important

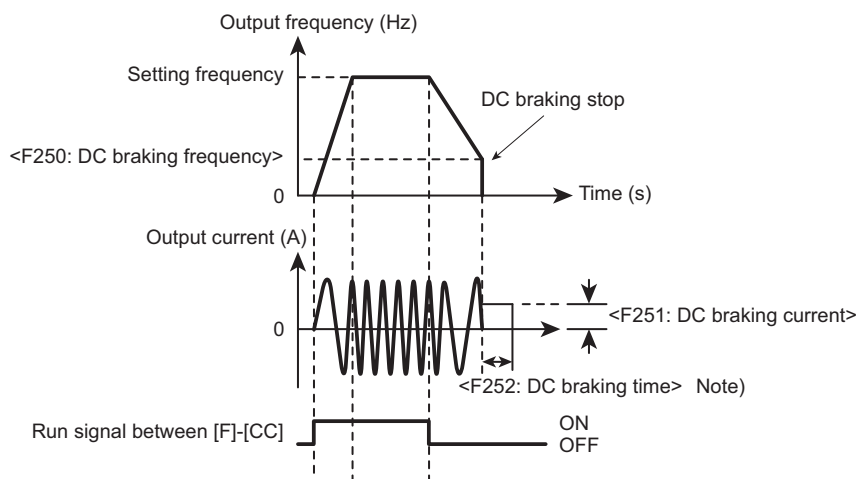

Note) Actually it will be longer than the setting value of <F252> because of the reduced voltage operation.

### ■ DC braking with the set frequency

When the inverter decelerates until the setting value of <F250: DC braking frequency>, it applies DC braking.

Set the DC braking amount with <F251: DC braking current>. Set the amount based on 100% meaning the rated current of the inverter. With <F701: Current, voltage units select> set to "1: A (ampere), V (volt)", specify a current value (A).

### ■ DC braking with an external signal

A signal input to the terminal can forcibly cause the inverter to apply DC braking.

Assign "22: DC braking" ("23" for inversion) to the input terminal.

DC braking is applied while the terminal is turned ON regardless of the settings of <F250: DC braking frequency> and <F252: DC braking time>.

Even when the terminal is turned OFF, it is applied for the period set with <F252: DC braking time>.

The DC braking amount depends on the setting of <F251: DC braking current>.

### Memo

- The carrier frequency when DC braking is in progress is the setting value of either <F249: DC braking carrier frequency> or <F300: Carrier frequency> which is lower.

### Reference

- How to operate the operation panel -> Refer to [3. 1. 1].
- How to switch display mode on the operation panel -> Refer to [3. 1. 2].
- Procedure to change parameter setting -> Refer to [4. 2. 3]
- Details on operation by external signals -> Refer to [Chapter 7].

## 6. 8. 2 Fixing the motor shaft with DC braking

<F254: Motor shaft fixing control>

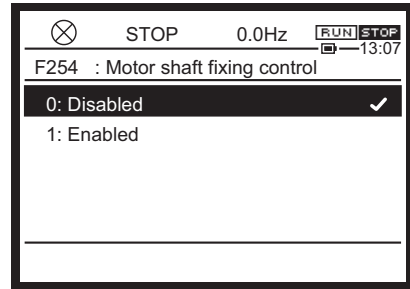

### ■ Function

Use DC braking to temporarily fix the motor shaft.  
This function is used to avoid the free rotation of the motor or to preheat the motor.

### ■ Parameter setting

Title	Parameter name	Adjustment range	Default setting
F254	Motor shaft fixing control	0: Disabled 1: Enabled	0

6

### ■ Selecting a setting value

#### 1: Enabled

Continue to apply DC braking at half the DC braking amount specified with <F251: DC braking current> after the normal DC braking action.

During shaft fixing control, "dbOn" appears on the LCD screen.

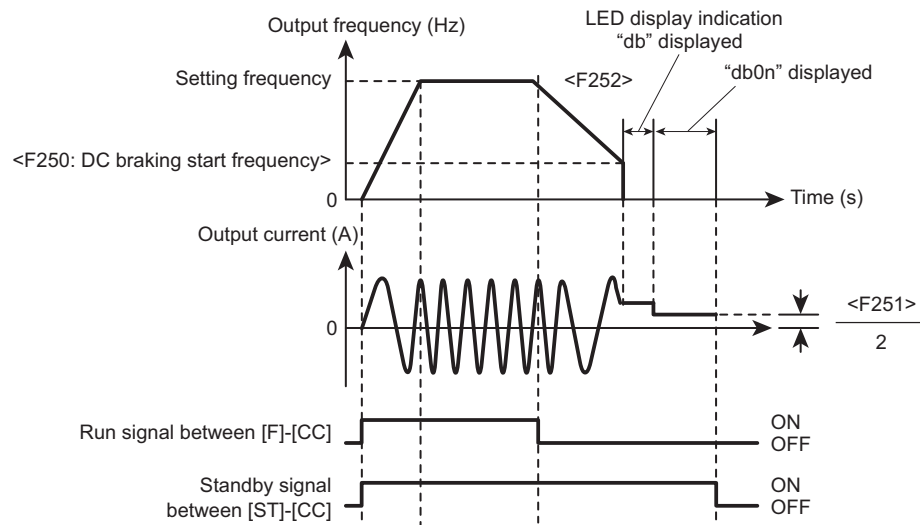

### ■ How to use

To perform motor shaft fixing control, set <F254: Motor shaft fixing control> to 1.  
To cancel it, turn OFF standby (ST) signal).



Since standby (ST) is always turned ON in the default setting, you should set values as shown below.

- Set <F110: Always active function 1> to "1: No function".
- Assign "6:ST" (standby) to an unused input terminal.

Cancel motor shaft fixing control if the following problems occur during motor shaft fixing control: the inverter coasts due to power failure, or it is restored with the retry function after a trip.

Even when DC braking is activated with a signal from the input terminal, the almost same motor shaft fixing control can be performed.

**Memo**

- The carrier frequency during shaft fixing control is the setting value of either <F249: DC braking carrier frequency> or <F300: Carrier frequency> which is lower.

**Reference**

- How to operate the operation panel -> Refer to [3. 1. 1].
- How to switch display mode on the operation panel -> Refer to [3. 1. 2].
- Procedure to change parameter setting -> Refer to [4. 2. 3]
- Details on operation by external signals -> Refer to [Chapter 7].

### 6. 8. 3 Making the motor standstill with PG feedback control

- <F255: 0Hz command select at stop>
- <F250: DC braking frequency>
- <F252: DC braking time>

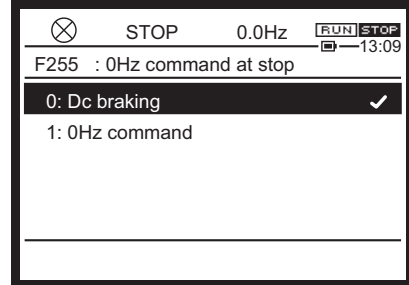

■ **Function**

This function works only for the speed control of PG feedback control. Use a way other than DC braking to make the motor standstill.

When this function is set, the inverter outputs a 0 Hz command instead of applying DC braking when stopping to make the motor standstill for the specified time.

6

■ **Parameter setting**

Title	Parameter name	Adjustment range	Unit	Default setting
F255	0Hz command select at stop	0: DC braking 1: 0 Hz command		0
F250	DC braking frequency	0.0 - FH	Hz	0.0
F252	DC braking time	0.0 - 25.5	s	1.0

■ **How to select a setting value**

**0: DC braking**

This function works as the DC braking function described in [6. 8. 1].

**1: 0 Hz command**

This function works only for the speed control of PG feedback control.

The inverter outputs 0 Hz for the period set with <F252: DC braking time> when the frequency reaches the setting value of <F250: DC braking frequency>.

It does not work when <F250: DC braking frequency> is set to "0.0".

With this function enabled, <F254: Motor shaft fixing control> cannot be used.

■ **How to use**

This function is used for PG feedback control (<Pt: V/f Pattern> = "10", "11").

You should set the terminals [S4] and [S5] or have any option for PG feedback.

The normal DC braking action (the same action set with <F255> = "0") is performed for non-PG feedback control.



## Important

- Note that a higher value of <250: DC braking frequency> will cause a command indicating the sudden stop of the motor from a high rotation state. A trip may occur depending on a load condition.

## Memo

- When <F255: 0Hz command select at stop> is set to "1", the inverter outputs a 0 Hz command instead of applying the following DC braking.  
DC braking with a command from the terminal or communication (input terminal function "22"/ "23", communication command)  
Emergency DC braking of DC braking emergency stop (<F603: Emergency off stop pattern> = "2") when the DC braking stop of the jog stop pattern is specified (<F261: Jog stop select> = "2")

## Reference

- How to operate the operation panel -> Refer to [3. 1. 1].
- How to switch display mode on the operation panel -> Refer to [3. 1. 2].
- Procedure to change parameter setting -> Refer to [4. 2. 3]
- Option for PG feedback -> Refer to "Digital Encoder Instruction manual" (E6582148).
- Details on operation by external signals -> Refer to [Chapter 7].

## 6.9 Automatic stop when run continues at the lower limit frequency (sleep function)

- <F256: Run sleep detection time>
- <F259: Run sleep detection time at startup>
- <F391: Sleep detection hysteresis>
- <F392: Wakeup deviation>
- <F393: Wakeup feedback>



### ■ Function

This function is used to automatically decelerate and stop the inverter in the following case: the inverter continues to run at the frequency set with <LL: Lower limit frequency>, which has a low workload, for the period specified in <F256: Run sleep detection time> for energy-saving, etc. (sleep function).

The LCD screen displays "LStP" during sleep.

6

### ■ Parameter setting

Title	Parameter name	Adjustment range	Unit	Default setting
F256	Run sleep detection time	0.0: Disabled 0.1 - 600.0	s	0.0
F259	Run sleep detection time at startup	0.0: Disabled 0.1 - 600.0	s	0.0
F391	Sleep detection hysteresis	0.0 - UL	Hz	0.0
F392	Wakeup deviation	0.0 - UL	Hz	0.0
F393	Wakeup feedback	0.0 - UL	Hz	0.2

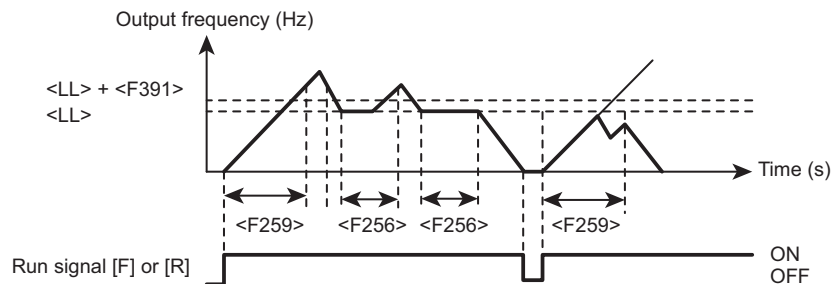

### ■ Guideline for the setting

This function is used to automatically decelerate and stop the inverter when it continues to run at the frequency set with <LL: Low limit frequency>.

Set a duration with <F256: Sleep detection time>.

When the inverter starts to run, the sleep function works after the output frequency is over the value of <LL: Lower limit frequency>.

Also, when it starts, this function enables you to automatically stop the inverter after the period set with <F259: Run sleep detection time at startup> if the output frequency does not increase to the value of <LL> due to a load error. However, if the output frequency is over the value of <LL>, the function of <F259> is invalid until the run signal is turned OFF

For non-PID control, this function is canceled when the frequency command value is over the values of <LL: Lower limit frequency> and <F391: Sleep detection hysteresis> (Hz) or when the run command is turned OFF.

For PID control, set values with <F392: Wakeup deviation> and <F393: Wakeup feedback>.  
For details, refer to the PID control instruction manual (E6582112).

This function is also valid when you switch between forward and reverse run.

---

**Reference**

- How to operate the operation panel -> Refer to [3. 1. 1].
- How to switch display mode on the operation panel -> Refer to [3. 1. 2].
- Procedure to change parameter setting -> Refer to [4. 2. 3]

# 6. 10 Jog run

- <F262: Panel jog run>
- <F260: Jog frequency>
- <F261: Jog stop select>

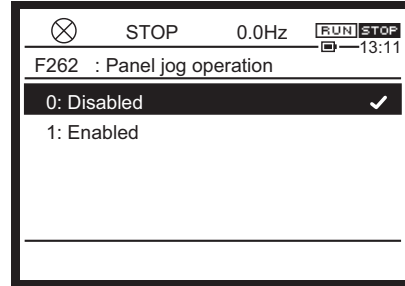

### ■ Function

Jog run represents inching the motor.

When you input a jog run signal, the inverter immediately outputs a jog run frequency regardless of the set acceleration time.

You can start/stop jog run even on the operation panel.

## 6

### ■ Parameter setting

Title	Parameter name	Adjustment range	Unit	Default setting
F262	Panel jog run	0: Disabled 1: Enabled		0
F260	Jog frequency	F240 - 20.0	Hz	5.0
F261	Jog stop select	0: Deceleration stop 1: Coast stop 2: DC braking stop		0

### ■ Setting example

Assign "18: jog run" to the unused input terminal.

While that input terminal is turned ON, the inverter can perform jog run.

To use only the panel jog run, you should not assign it to the input terminal.

Example) When it is assigned to the terminal [RES]: <F113: Terminal RES function 1> = "18"

The inverter outputs a low-speed detection signal but does not output an output frequency attainment signal during jog run. Also, PID control is disabled.

<Example of jog run>

Terminal [RES] (JOG): ON + terminal [F]: Forward jog run when the terminal is turned ON

Terminal [RES] (JOG): ON + terminal [R]: Reverse jog run when the terminal is turned ON

(Frequency command + terminal [F]: Forward run when the terminal is turned ON, terminal [R]:

Reverse run when the terminal is turned ON)

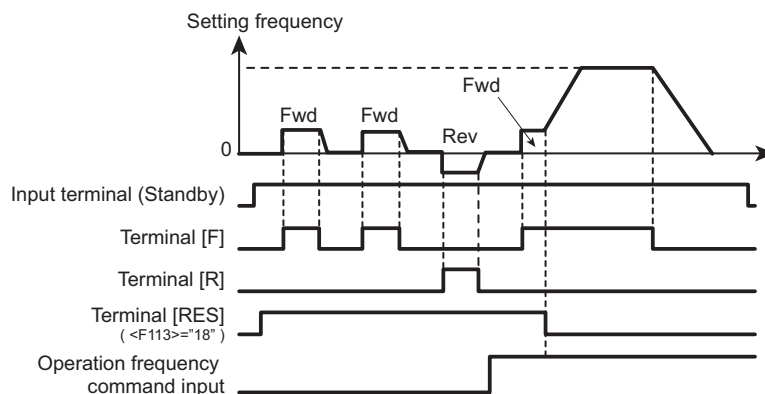

- The terminal [RES] (JOG) is valid when the output frequency is the jog frequency or less. It does not work when the output frequency is higher than the jog frequency.
- The inverter can perform jog run while the terminal [RES] (JOG) is turned ON.
- Jog run is prioritized even if a run command is input on the way.
- Even when <F261: Jog stop select> is set to "0" or "1", DC braking is applied for emergency DC braking (F603: Emergency off stop pattern = "2").
- The jog frequency is not limited by <UL: Upper limit frequency>.

6

#### ■ Panel jog run (when <F262: Panel jog run> is set to 1)

Each time you press the [FWD/REV] key, the state of jog run is switched as follows:

- The inverter performs forward jog run while the [F4] key is pressed.
- The inverter performs reverse jog run while the [F4] key is pressed.
- When you press the key for 20 seconds or more, the key failure alarm "A-17" appears.

The inverter cannot move to panel jog run while it runs or a run command is input.

#### Reference

- How to operate the operation panel -> Refer to [3. 1. 1].
- How to switch display mode on the operation panel -> Refer to [3. 1. 2].
- Procedure to change parameter setting -> Refer to [4. 2. 3]
- Details on operation by external signals -> Refer to [Chapter 7].

## 6. 11 Jumping the frequency to avoid the resonant frequency

- <F270: Jump frequency 1>
- <F271: Jump frequency 1 band>
- <F272: Jump frequency 2>
- <F273: Jump frequency 2 band>
- <F274: Jump frequency 3>
- <F275: Jump frequency 3 band>

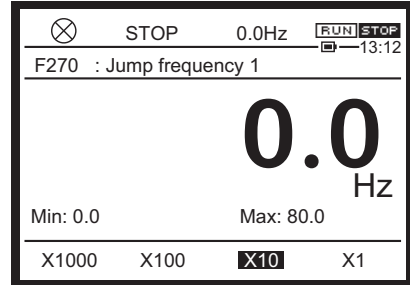

### ■ Function

When you want to avoid resonance caused by the natural frequency of the mechanical system to run the inverter, the resonant frequency can be jumped.  
This characteristic has hysteresis given to the jump frequency.

6

### ■ Parameter setting

Title	Parameter name	Adjustment range	Unit	Default setting
F270	Jump frequency 1	0.0 - FH	Hz	0.0
F271	Jump frequency 1 band	0.0 - 30.0	Hz	0.0
F272	Jump frequency 2	0.0 - FH	Hz	0.0
F273	Jump frequency 2 band	0.0 - 30.0	Hz	0.0
F274	Jump frequency 3	0.0 - FH	Hz	0.0
F275	Jump frequency 3 band	0.0 - 30.0	Hz	0.0

### ■ Setting method

You can set three jump frequencies. To do that, avoid the overlap of the adjustment range of each jump frequency.  
The frequency does not jump during acceleration or deceleration.

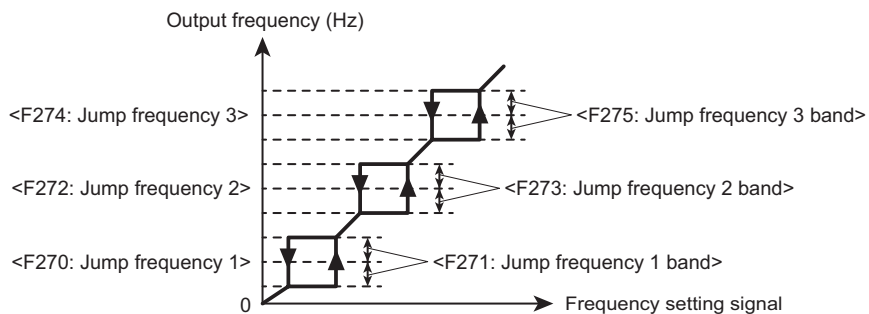



**Reference**

- How to operate the operation panel -> Refer to [3. 1. 1].
- How to switch display mode on the operation panel -> Refer to [3. 1. 2].
- Procedure to change parameter setting -> Refer to [4. 2. 3]

## 6. 12 Setting the preset-speed operation frequency

### 6. 12. 1 Setting the preset-speed operation frequency

- <F287: Preset speed 8>
- <F288: Preset speed 9>
- <F289: Preset speed 10>
- <F290: Preset speed 11>
- <F291: Preset speed 12>
- <F292: Preset speed 13>
- <F293: Preset speed 14>
- <F294: Preset speed 15 / Forced run speed>
- <F560: Preset speed operation style>
- <F561: Operation function (1-speed)> through <F575: Operation function (15-speed)>
- <F576: Operation function (0-speed)>

For details of preset speed operation, refer to [5. 3. 7].

6

### 6. 12. 2 Forced run in emergency

- <F294: Preset speed 15 / Forced run speed>

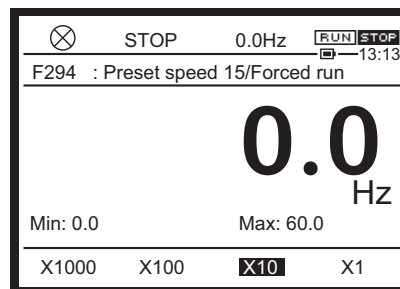

#### ■ Function

You can run the inverter at a specified speed (frequency) in emergencies or continue to forcibly run it during slight failure. When the input terminal with the assigned function is turned ON, the inverter runs at the frequency set with <F294: Preset speed 15 / Forced run speed> regardless of run and frequency commands.

#### ■ Parameter setting

Title	Parameter name	Adjustment range	Unit	Default setting
F294	Preset speed 15 / Forced run speed	LL - UL	Hz	0.0

#### ■ Guideline for the setting

Assign the function to unused input terminal.

- When the inverter runs at a specified speed in an emergency

Input terminal function "58: Fire speed run"

- When the inverter continues to forcibly run even during slight failure

Input terminal function "56: Forced run"

When the input terminal with the assigned function is turned ON, the inverter runs at the frequency set with <F294: Preset speed 15 / Forced run speed>.

## 6. 13 Bumpless operation

<F295: Bumpless>

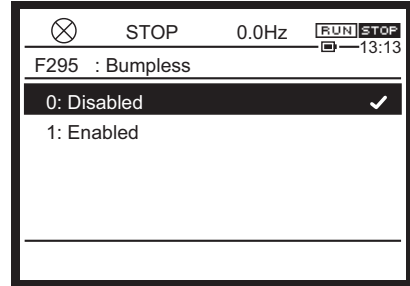

### ■ Function

This function is used to pass on the run/stop state and output frequency under the automatic operation to the manual operation when a switch between the two operation modes is made.

When a switch from the manual to automatic operation is made, the operation status under the manual operation is not passed on to the automatic operation.

### ■ Parameter setting

Title	Parameter name	Adjustment range	Default setting
F295	Bumpless	0: Disabled 1: Enabled	0

### ■ How to use

The [HAND/AUTO] key is used to make a switch between the manual and automatic operations.

- [HAND] indicates the panel operation at hand. (Manual operation)
- [AUTO] indicates the operation method selected by <CMOD: Run command select> or <FMOD: Frequency command select 1> (or <F207: Frequency command select 2>). (Automatic operation)

### ■ Operation example

When <CMOD: Run command select> is "0: Terminal" under the automatic operation

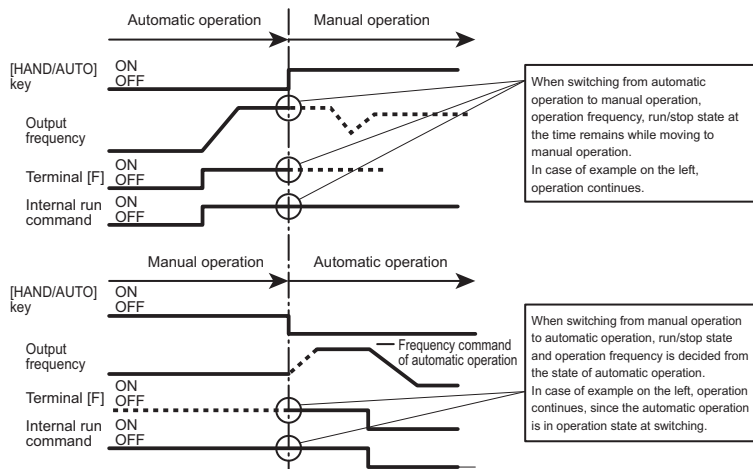

When you do not want to pass on the run/stop state and output frequency under the automatic operation to the manual operation, set <F295> to "0: Disabled".

**Reference**

- How to operate the operation panel -> Refer to [3. 1. 1].
- How to switch display mode on the operation panel -> Refer to [3. 1. 2].
- Procedure to change parameter setting -> Refer to [4. 2. 3]

## 6. 14 Changing carrier frequency to reduce noise and magnetic noise

<F300: Carrier frequency>

<F312: Random switching>

<F316: Carrier frequency control>

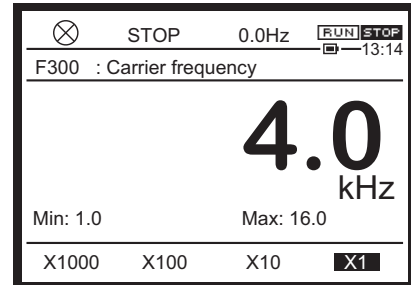

### ■ Function

The inverter noise can be reduced by decreasing the carrier frequency.

You can respond to unpleasant motor acoustic noise by increasing the carrier frequency or changing the tone with the random switching.

Adjustment of carrier frequency is effective when a resonance with a load machine or motor fan cover occurs.

However, note that a low carrier frequency causes the motor acoustic noise to increase, and a high carrier frequency causes the inverter electro-magnetic noise to increase.

### ■ Parameter setting

#### ■ <F300: Carrier frequency> setting

Some models require current reduction depending on the <F300: Carrier frequency> setting and ambient temperature.

#### ■ <F312: Random switching> setting

When you want to reduce the motor acoustic noise with a low carrier frequency, set <F312: Random switching>. The tone can be changed.

This function works in the low output frequency range producing unpleasant acoustic noise from the motor.

<F312: Random switching> has three different tones: "1", "2" and "3". Select the appropriate setting for the load.

With <F300: Carrier frequency> set to 8.0 kHz or more, the motor acoustic noise decreases, and thus the random switching does not function.

#### ■ <F316: Carrier frequency control> setting as a measure to protect motors against surge voltages

When a 480 V class inverter is used to operate a motor, very high surge voltages may be produced depending on the wire length, wire routing and types of wires used.

Here are some examples of measures against surge voltages.

- Decrease <F300: Carrier frequency>.

- When the wire length between the inverter and motor is long (approx. 20 to 100 m), set <F316: Carrier frequency control> to "2" or "3".
- Turn off power to set <F316: Carrier frequency control> to "2" or "3".
- Install a sinusoidal filter to the output side of inverter. In this case, set <F316: Carrier frequency control> to "4" or "5".
- Use a motor with high insulation strength.



Important

- When no decrease of carrier frequency is selected while a high carrier frequency is set, a trip occurs by Overheat (OH), etc. more easily than the case with automatic decrease.
- With <F316: Carrier frequency control> set to "2" or "3", the carrier frequency is restricted to 4 kHz or less automatically.
- With <F316: Carrier frequency control> set to "4" or "5", the carrier frequency is 4 kHz or more automatically.
- With <Pt: V/f pattern> set to "2" - "6" or "9" - "12", the carrier frequency is 2 kHz or more automatically.

■ **Reduction of load current**

When the ambient temperature is above 40 or 50°C, reduce the current according to "Instruction manual for load reduction" (E6582116).

An IGBT overload pre-alarm "L" or overheat pre-alarm "H" is displayed when the IGBT overload "OL3" or overheat "OH" protection level nears.

With <F316: Carrier frequency control> set to "1", "3" or "5", carrier frequency is decreased at IGBT overload pre-alarm, or overheat pre-alarm to try to prevent "OL3" or "OH"trip. When the cumulative amount of overload further increases, an "OL3" or "OH" trip will occur. In this case, decrease <F601: Stall prevention level 1> to avoid trips.

Even when <F300: Carrier frequency> is set to a low value, the carrier frequency increases in the high output frequency range to ensure stable operation.

Reference

- How to operate the operation panel -> Refer to [3. 1. 1].
- How to switch display mode on the operation panel -> Refer to [3. 1. 2].
- Procedure to change parameter setting -> Refer to [4. 2. 3]

## 6. 15 Avoiding trips

Occurrences of trips may be avoided using the appropriate function in consideration of the causes of alarms or trips.

### 6. 15. 1 Restarting smoothly after momentary power failure (restarting from motor coasting state)

<F301: Auto-restart>

For detailed settings of auto-restart, refer to [5. 4. 2].

### 6. 15. 2 Selecting operation for momentary power failure

<F302: Regenerative power ride-through>

<F310: Dec time at power failure>

<F313: Ridethrough time>

<F317: Synchronized stop time>

<F318: Synchronized reach time>

<F625: Undervoltage detection level>

<F629: Regenerative power ride-through level>

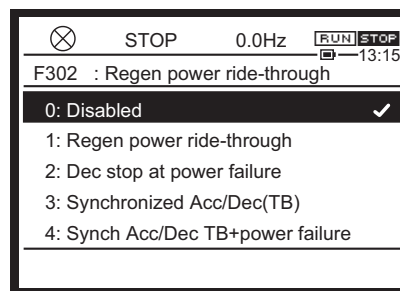

#### ■ Function

Select the reaction to a momentary power failure during operation from regenerative power ride-through, deceleration stop at power failure and synchronized Acc/Dec.

- Regenerative power ride-through: When a momentary power failure occurs, the operation is continued using the regenerative energy of the motor.
- Deceleration stop at power failure: When a momentary power failure occurs, the operation is stopped forcibly and swiftly using the regenerative energy of the motor. The deceleration time varies by the control. "StOP" is displayed on the operation panel during the stop. After the deceleration stop at power failure, the stop state is kept until the run command is turned OFF.
- Synchronized Acc/Dec: For a spindle winder of textile machine or the like, multiple machines are stopped in a lined-up manner or brought to reach the frequency command simultaneously during momentary power failure or restoration of power to prevent thread breakage.

#### ■ Parameter setting

Title	Parameter name	Adjustment range	Unit	Default setting
F302	Regenerative power ride-through	0: Disabled 1: Regenerative power ride-through 2: Deceleration stop at power failure 3: Synchronized Acc/Dec (TB) 4: Synchronized Acc/Dec (TB + power failure)		0
F310	Dec time at power failure	0.0 - 320.0	s	2.0



Title	Parameter name	Adjustment range	Unit	Default setting
F313	Ridethrough time	0.0: Continuous 0.1 - 320.0	s	2.0
F317	Synchronized stop time	0.0 - 6000	s	2.0
F318	Synchronized reach time	0.0 - 6000	s	2.0
F625	Undervoltage detection level	50 - 79 80: Auto	%	80
F629	Regenerative power ridethrough level	55 - 100	%	75

■ **Selecting the setting value**

When using the regenerative power ride-through: <F302: Regenerative power ride-through> = "1"

- Set <F302> to "1: Regenerative power ride-through".
- A motor is controlled according to <F313: Ridethrough time>.
 

Note that the available time to continue the operation varies by the mechanical inertia or load condition. The motor may enter the coasting state depending on the load condition.
- Set the operation level of regenerative power ride-through with <F629: Regenerative power ride-through level>.
 

100% reference is 200 V (240V class), 400 V (480V class)

Set it to a value equal to <F625: Undervoltage detection level> decreased by 5%, or more. Or, set it to a value equal to <F629: Regenerative power ridethrough level> increased by 5%. If the setting is inappropriate, the regenerative power ride-through control time may become too short. This is not required when <F625> is "80: Auto".
- When <F303: Retry> is used together, you can restart a motor without stopping it in case a trip occurs.
- To restart a motor smoothly after restoration of power, use <F301: Auto-restart> together.
- This does not function during torque control.

When using the deceleration stop at power failure: <F302: Regenerative power ride-through> = "2"

- Set <F302> to "2: Deceleration stop at power failure".
- A motor makes a deceleration stop according to <F310: Dec time at power failure>. The deceleration time is from <FH: Maximum frequency> to 0 Hz. With <F302> set to "2", <F310> cannot be written during run.
- Set the operation level of deceleration stop at power failure with <F626: Overvoltage limit operation level>. 100% reference is 200 V (240V class), 400 V (480V class).
- When the voltage falls to <F625: Undervoltage detection level> or less during a deceleration stop due to power failure, the motor will enter the coasting state.
- "StOP" is displayed on the operation panel during the stop. The stop state is kept until the run command is turned OFF.
- This does not function during torque control.

When using the synchronized Acc/Dec: <F302: Regenerative power ride-through> = "3" or "4"

- Set <F302> to "3: Synchronized Acc/Dec (TB)" or "4: Synchronized Acc/Dec (TB + power failure)".
- The deceleration time set by <F317: Synchronized stop time> and acceleration time set by <F318: Synchronized reach time> are used.
- This does not function during torque control.
- The jog run is disabled while this function is set.

■ Setting example of <F302: Regenerative power ride-through> = "1"

1) When the power supply is shut off

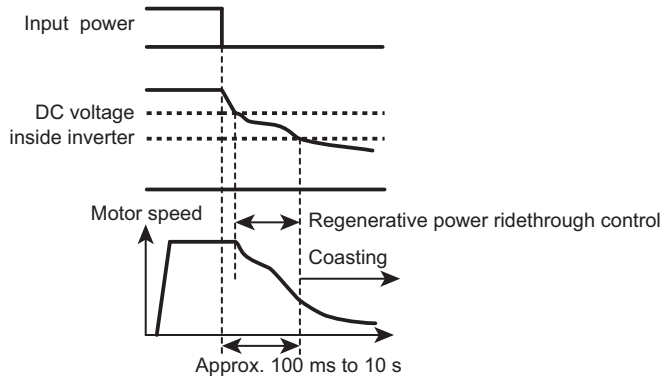

\* Available time to continue the operation varies by the mechanical inertia or load condition. Perform verification test when using this function.

\* Using retry function at the same time enables to automatically restart without failure stop.

When the power supply is shut off during deceleration stop, deceleration stop corresponding to F302=2 is operated instead of regenerative power ride through.

This function does not work well at high speed in PM control.

Do not set this function in case of PM high speed drive.

6

2) When a momentary power failure occurs

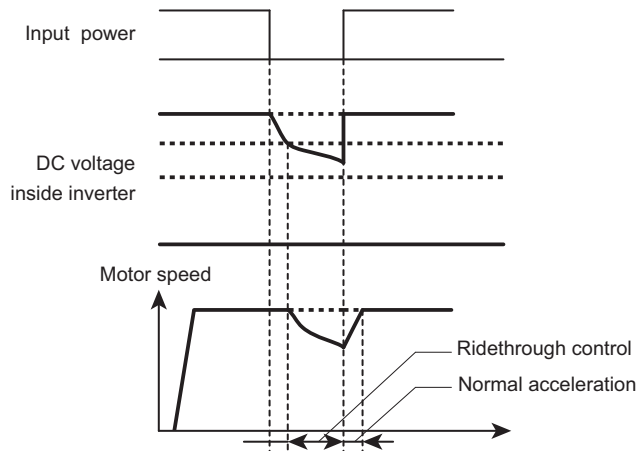

When a momentary power failure occurs during deceleration stop, the regenerative power ride-through does not function.

### ■ Setting example of <F302: Regenerative power ride-through> = "2"

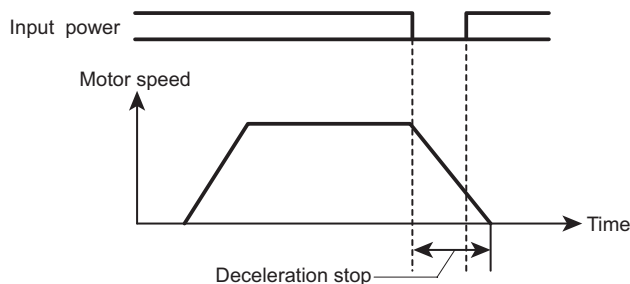

- The motor makes a deceleration stop also when the power is restored. However, when the voltage in power circuit inside the inverter falls to or below a certain value, the control is stopped and the motor enters the coasting state.
- A motor makes a deceleration stop according to <F310: Dec time at power failure>. The deceleration time is from <FH: Maximum frequency> to 0 Hz.
- When the voltage falls to <F625: Undervoltage detection level> or less during a deceleration stop due to power failure, the motor will enter the coasting state. The display shows "StOP", and the motor is kept in the coasting state after power is restored.

6

### ■ Setting example of <F302: Regenerative power ride-through> = "3"

When <F114: Terminal S1 function 1> is set to "62: Synchronized Acc/Dec", and a power failure synchronized signal is allocated to the terminal [S1].

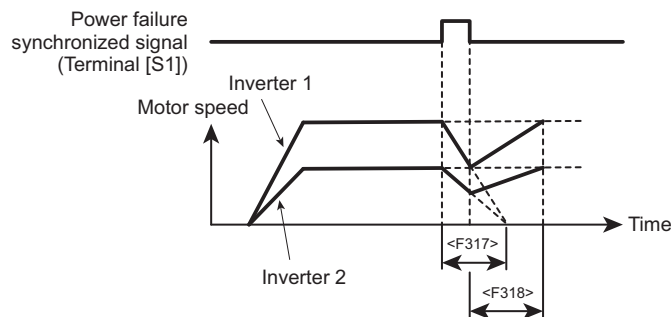

- When the terminal [S1] is turned ON with <F317: Synchronized stop time> and <F318: Synchronized reach time> of acceleration/deceleration set to the same value, multiple motors can be stopped almost at the same time. After power is restored, the motors can reach respective frequency command values almost at the same time.
- When the terminal [S1] is turned ON, linear deceleration is performed for the specified time by <F317> from the output frequency at this point to 0 Hz. The S-pattern deceleration and brake sequence are unavailable.  
"StOP" is displayed when the stop process is completed.
- When the terminal [S1] is turned OFF during synchronized deceleration, linear acceleration is performed for the specified time by <F318: Synchronized reach time> from the output frequency at this point to the output frequency at which the synchronized deceleration was started or frequency command value, whichever is lower. The S-pattern acceleration, brake sequence and auto-tuning are unavailable.  
"StOP" disappears when acceleration is started.

- When a Fwd/Rev switching or stop command is input during synchronized deceleration, synchronized acceleration/deceleration stops.
- To operate a motor again after a synchronized deceleration function stop, turn OFF the terminal [S1].
- When using the synchronized deceleration function, check that the overvoltage stall prevention function is not working during deceleration.

■ **Setting example of <F302: Regenerative power ride-through> = "4"**

When <F114: Terminal S1 function 1> is set to "62: Synchronized Acc/Dec", and a power failure synchronized signal is allocated to the terminal [S1].

Synchronized deceleration is performed when the terminal [S1] is ON or power failure occurs, and synchronized acceleration is performed when the terminal [S1] is OFF or restoration of power occurs.

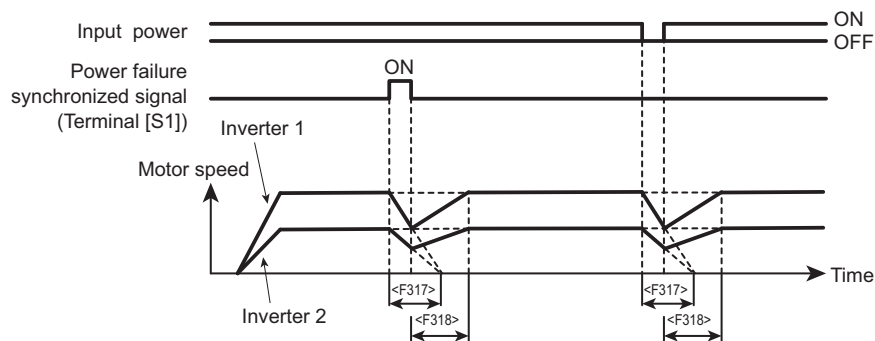

- When <F302> is set to "1", "2" or "4", the voltage in power circuit inside the inverter is controlled between <F625: Undervoltage detection level> and <F629: Regenerative power ride-through level>.
- When the voltage falls to <F625: Undervoltage detection level> or less, the power circuit undervoltage (MOFF) alarm is displayed and the motor enters the coasting state. If "MOFF" is displayed immediately after a power failure, adjust by decreasing the <F625> setting or slightly increasing the <F629: Regenerative power ride-through level> setting.

Reference

- How to operate the operation panel -> Refer to [3. 1. 1].
- How to switch display mode on the operation panel -> Refer to [3. 1. 2].
- Procedure to change parameter setting -> Refer to [4. 2. 3]
- Details on operation by external signals -> Refer to [Chapter 7].

### 6. 15. 3 Automatic reset at trip (retry function)

**CAUTION**

Mandatory action

- Do not go near the motor or machine.
- When the retry function is selected, the motor/machine stopped at an occurrence of alarm will be started after a selected period of time (suddenly). Going near the motor/machine may result in unexpected injury.
- Affix the caution label about sudden restart in retry function to the inverter, motor and machine. Take a preventive measure against accidents.

<F303: Retry>

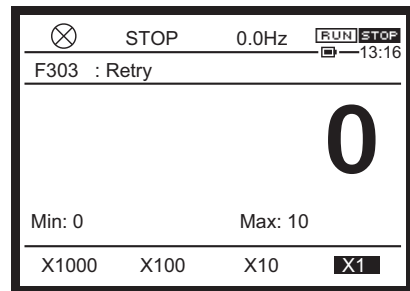

6

■ **Function**

The inverter is reset automatically when a trip occurs.  
 During retry, the motor speed search is activated automatically as occasion demands to start a motor smoothly.

■ **Parameter setting**

Title	Parameter name	Adjustment range	Unit	Default setting
F303	Retry	0: Disabled 1 - 10	Times	0

■ **How to use**

The following table shows the causes of trip and retry processes.

Cause of trip	Retry process	Stop condition
Overcurrent Overvoltage Overload Overheat Step out (PM only)	Consecutive retries up to 10 times 1st time: Approx. 1 second after occurrence of a trip 2nd time: Approx. 2 seconds after occurrence of a trip 3rd time: Approx. 3 seconds after occurrence of a trip ... 10th time: Approx. 10 seconds after occurrence of a trip	A trip other than overcurrent, overvoltage, overload, overheat and step-out detection occurs during retry. Retry fails with the specified number of times.

Followings are the trips of retry targets.  
 "OC1" , "OC2" , "OC3" , "OP1" , "OP2" , "OP3" , "OL1" , "OL2" , "OL3" , "OLr" , "OH" , "SOUT"

During retry, "rtry" is displayed on LCD screen.

The retry count is cleared (number of retry: 0) after a specified time without occurrence of trips from a retry success.

A retry success means that the output frequency reaches the frequency command value without tripping.



Important

- A failure signal is not output during retry.  
A "10: Failure signal 1" is allocated to the [FLA]-[FLB]-[FLC] terminals in the default setting.
- To output a failure signal during retry, allocate the function "116: Failure signal 4" or "117" to the output terminal.
- The virtual cooling time is provided for the overload trips "OL1", "OL2", and "OLr".  
A retry is performed after the virtual cooling time and retry time elapse.
- For the overvoltage trips "OP1", "OP2" and "OP3", a retry is performed after the voltage in the DC section decreases.
- For the overheat trip "OH", a retry is performed after the inverter internal temperature decreases to the operable level.

## 6

### Reference

- How to operate the operation panel -> Refer to [3. 1. 1].
- How to switch display mode on the operation panel -> Refer to [3. 1. 2].
- Procedure to change parameter setting -> Refer to [4. 2. 3]
- Details on operation by external signals -> Refer to [Chapter 7].

## 6. 15. 4 Dynamic braking - Abrupt motor stop

- <F304: Dynamic braking, OLR trip>
- <F308: Braking resistance>
- <F309: Braking resistor capacity>
- <F626: Overvoltage limit operation level>
- <F639: Braking resistor overload time>

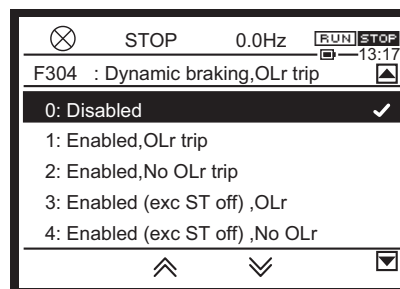

### ■ Function

The dynamic braking function can be enabled by connecting an external braking resistor.

- When an abrupt deceleration is necessary
- When an overvoltage "OP" trip occurs at a deceleration stop
- When the continuous regenerative state, such as moving down of a lifting gear and winding-out operation for tension control, is entered
- When the regenerative state is entered by load fluctuation during constant speed run of a press machine, etc.

6

### ■ Parameter setting

Title	Parameter name	Adjustment range	Unit	Default setting
F304	Dynamic braking, OLR trip	0: Disabled 1: Enabled, OLR trip 2: Enabled, No OLR trip 3: Enabled (except during ST OFF), OLR trip 4: Enabled (except during ST OFF), No OLR trip 5: Enabled (except during trip), OLR trip 6: Enabled (except during trip), No OLR trip 7: Enabled (except during trip & ST OFF), OLR trip 8: Enabled (except during trip & ST OFF), No OLR trip		0
F308	Braking resistance	0.5 - 1000	Ω	*1
F309	Braking resistor capacity	0.01 - 600.0	kW	*1
F626	Overvoltage limit operation level	100 - 150	%	134
F639	Braking resistor overload time	0.1 - 600.0	s	5.0

\*1 Depending on capacity, refer to [11. 6].

### ■ How to use

To use dynamic braking, set <F304: Dynamic braking, OLR trip> to "1" - "8" (dynamic braking enabled). At this time, the overvoltage limit operation is automatically disabled as in the case of <F305: Overvoltage limit operation> ="1: Disabled", and the regenerative energy of the motor is consumed by a braking resistor. (Refer to [6. 15. 5].)

Set <F308: Braking resistance> and <F309: Braking resistor capacity> according to the braking resistor to be connected.

Set the overload time of braking resistor with <F639: Braking resistor overload time>. Set a value so that a trip occurs at a value 10 times the <F309: Braking resistor capacity> setting. The default setting is intended for our recommended braking resistors (DGP600 Series excluded). To use the DGP600 Series, use the characteristic value of overload relay as a guide.

Set the operation level of dynamic braking with <F626: Overvoltage limit operation level>.

To output an overload of braking resistor, allocate the braking resistor overload (OLr) pre-alarm (function number: "30" , "31") to the output terminal.

■ **Setting example**

When using an external braking resistor (option)

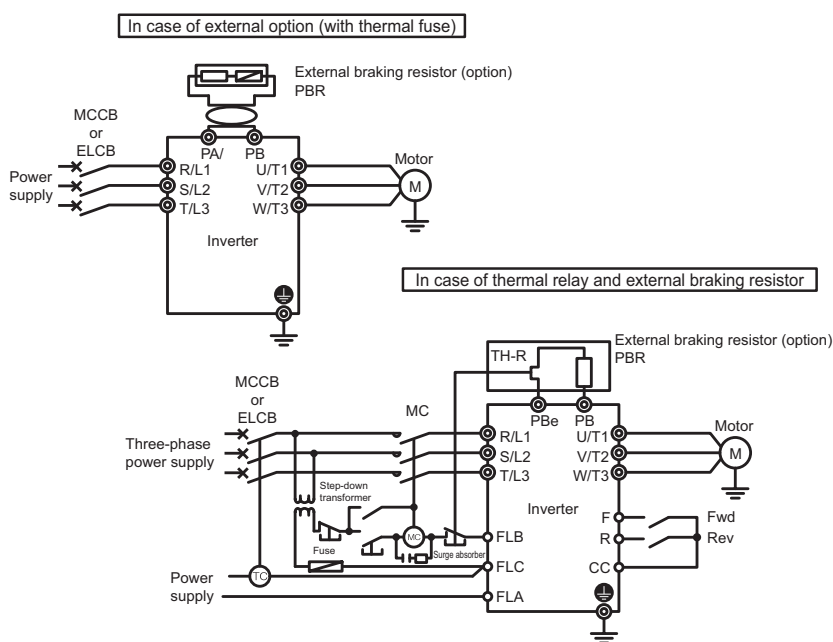

The above connection is for the case where MCCB or ELCB with a trip coil is used instead of MC for TC (trip coil).

Prepare a step-down transformer for the 480V class. It is not required for the 240V class.



Important

- Be sure to install a thermal relay (THR) to prevent fire.  
The inverter is equipped with the functions that protect a braking resistor from overload or overcurrent. A thermal relay needs to be activated when these protective functions become disabled.
- Select the appropriate thermal relay (THR) according to the braking resistor capacity (watt).
- "Thermal overload relay" is recommended, install it for each motor to be protected.
- "Thermal relay with CT" is not available.

For an application that requires the continuous regenerative state, such as moving down of a lifting gear, press and tension control, or when a deceleration stop is performed for a machine with large load inertial moment, increase the braking resistor capacity according to the operation rate.



Connect a braking resistor with a resistance value greater than the minimum allowable resistance value (resultant resistance value). Be sure to set <F308: Braking resistance> and <F309: Braking resistor capacity> for overload protection.

To use a braking resistor without thermal fuse, connect a thermal relay to shut off the power.

■ **Braking resistor option**

Following table shows the optional braking resistors. Operation rate is 3%ED.

Rating shows resultant resistance capacities (watt) and resultant resistance values (ohm).

A braking resistor for frequent regenerative braking is also available. Please contact your Toshiba distributor for information.

The type-form "PBR-" features built-in thermal fuse, and "PBR7-" features built-in thermal fuse and thermal relay.

The default settings of <F308: Braking resistance> and <F309: Braking resistor capacity> are intended for the optional braking resistors.

■ **Minimum resistance of connectable braking resistor**

Following shows the minimum resistance of connectable braking resistor.

Use a braking resistor with a resistance value greater than the minimum allowable resistance value (resultant resistance value).

■ **Minimum resistances of connectable braking resistors**

Voltage class	Inverter output capacity (kW at HD)	Minimum allowable resistance (Ω)
3-phase 240V	0.4 to 4.0	7.9
	5.5, 7.5	5.3
	11, 15	5
	18.5	4.5
	22 to 55	1
3-phase 480V	0.4 to 1.5	78
	2.2, 4.0	31.2
	5.5, 7.5	22.3
	11 to 18.5	15.6
	22, 30	12
	37	7.9
	45 to 75	2.5
	90 to 160	1.9
	220 to 280	1

**Reference**

- How to operate the operation panel -> Refer to [3. 1. 1].
- How to switch display mode on the operation panel -> Refer to [3. 1. 2].
- Procedure to change parameter setting -> Refer to [4. 2. 3]

## 6. 15. 5 Avoiding overvoltage trip

- <F305: Overvoltage limit operation>
- <F319: Regenerative over-flux upper limit>
- <F626: Overvoltage limit operation level>

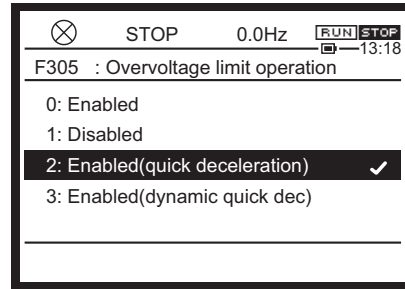

### ■ Function

These parameters are used to temporarily maintain the output frequency constant or increase the frequency to prevent overvoltage tripping when the voltage in the DC section rises during deceleration or while constant speed run is in progress (overvoltage limit operation).



Important

- During overvoltage limit operation, deceleration time may be longer than the time set.
- During overvoltage limit operation, the overvoltage (OP) pre-alarm is displayed.

6

### ■ Parameter setting

Title	Parameter name	Adjustment range	Unit	Default setting
F305	Overvoltage limit operation	0: Enabled 1: Disabled 2: Enabled (quick deceleration) 3: Enabled (dynamic quick deceleration)		2
F319	Regenerative over-flux upper limit	100 - 160	%	*1
F626	Overvoltage limit operation level	100 - 150	%	134 *1

\*1 Depending on the setup menu. For details, refer to [11. 6].

### ■ Difference in specific settings

#### <F305: Overvoltage limit operation> = "2"

This value sets quick deceleration.

When the voltage reaches the overvoltage limit operation level during deceleration, the motor may be decelerated more quickly than normal deceleration by increasing the voltage to be applied to the motor (over-excitation control) to increase the amount of energy consumed by the motor.

#### <F305: Overvoltage limit operation> = "3"

This value sets dynamic quick deceleration.

The motor may be decelerated more quickly than quick deceleration by increasing the voltage to be applied to the motor (over-excitation control) to increase the amount of energy consumed by the motor as soon as the motor starts decelerating.

<F319: Regenerative over-flux upper limit> is enabled when <F305: Overvoltage limit operation> is set to "2" or "3".

This parameter is used to adjust the maximum value of energy the motor consumes during deceleration. Increase this value if overvoltage tripping occurs during deceleration.

<F626: Overvoltage limit operation level> also serves as the parameter to set the dynamic braking level.

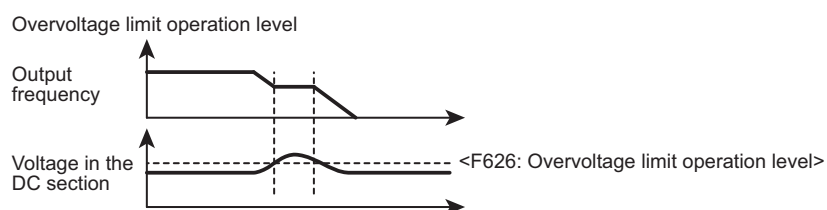

#### Reference

- How to operate the operation panel -> Refer to [3. 1. 1].
- How to switch display mode on the operation panel -> Refer to [3. 1. 2].
- Procedure to change parameter setting -> Refer to [4. 2. 3]

## 6. 15. 6 Adjusting and limiting output voltage

<F307: Supply voltage compensation, Output voltage limitation>

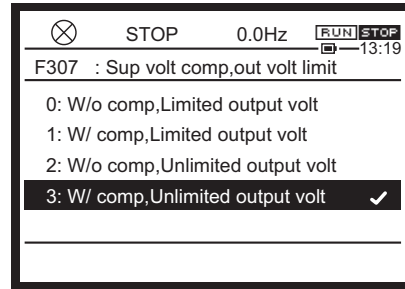

### ■ Function

- Supply voltage compensation: maintains a constant V/f ratio even when the input voltage fluctuates to suppress torque reduction in the low-speed range.
- Output voltage limitation: limits the output voltage so that voltage set with <vLv: Base frequency voltage 1> or more will not be output at frequency set with <vL: Base frequency 1> or more. This function is used when operating a special motor with low induced voltage.

6

### ■ Parameter setting

Title	Parameter name	Adjustment range	Default setting
F307	Supply voltage compensation, Output voltage limitation	0: Without supply voltage compensation, Limited output voltage 1: With supply voltage compensation, Limited output voltage 2: Without supply voltage compensation, Unlimited output voltage 3: With supply voltage compensation, Unlimited output voltage	*1

\*1 Depending on the setup menu. Refer to [5. 3. 10], [11. 10].

### ■ Selecting a setting value

- To maintain a constant V/f ratio even when the input voltage fluctuates to suppress torque reduction in the low-speed range, set <F307: Supply voltage compensation, Output voltage limitation> to "1" or "3" (With supply voltage compensation).  
When <F307> is set to "0" or "2", output voltage will change in proportion to the input voltage.
- The output voltage can be limited according to the motor rating. When <F307> is set to "0" or "1", the output voltage will be limited to <vLv: Base frequency voltage 1> when operated at frequency set with <vL: Base frequency 1> or more.
- Even if <vLv> is set to the input voltage or more, the output voltage will not exceed the input voltage.
- When <Pt: V/f Pattern> is set to "2" - "6" or "9" - "12", With supply voltage compensation will be set regardless of the <F307> setting.

<F307>= "0: Without supply voltage compensation, Limited output power"

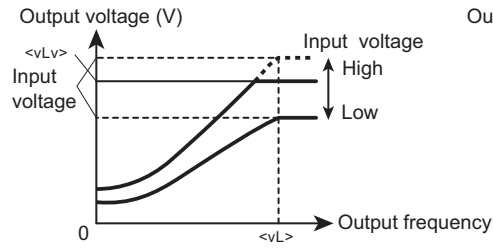

<F307>= "1: With supply voltage compensation, Limited output power"

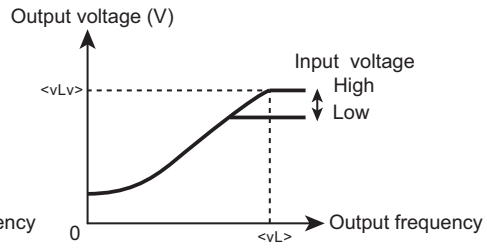

<F307>= "2: Without supply voltage compensation, Unlimited output power"

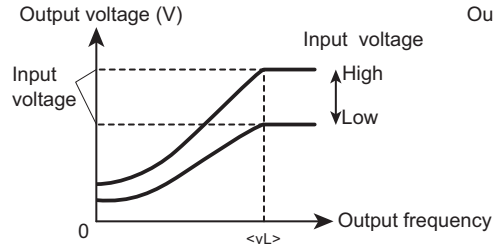

<F307>= "3: With supply voltage compensation, Unlimited output power"

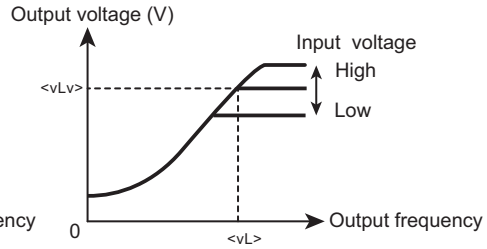

Rated voltages are fixed to values 240 V class: 200 V and 480 V class: 400 V.

Reference

- How to operate the operation panel -> Refer to [3. 1. 1].
- How to switch display mode on the operation panel -> Refer to [3. 1. 2].
- Procedure to change parameter setting -> Refer to [4. 2. 3]

## 6. 15. 7 Inhibiting Reverse run

<F311: Reverse inhibited>

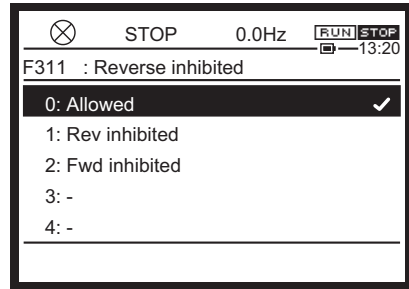

### ■ Function

This function limits the direction of rotation when the wrong Fwd or Rev run command is input.

### ■ Parameter setting

Title	Parameter name	Adjustment range	Default setting
F311	Reverse inhibited	0: Allowed 1: Rev inhibited 2: Fwd inhibited 3, 4: -	0



Important

- When the motor is operated in the inhibited direction during operations such as preset speed operation with functions or jog run, the run command will be set to OFF.
- If the motor parameters are not set to the appropriate values when vector control or automatic torque boost is set, the motor may run in the reverse direction at approximately the slip frequency.  
Set <F243: End frequency> to approximately the slip frequency.

### Reference

- How to operate the operation panel -> Refer to [3. 1. 1].
- How to switch display mode on the operation panel -> Refer to [3. 1. 2].
- Procedure to change parameter setting -> Refer to [4. 2. 3]

## 6. 16 Single load sharing by multiple inverters (droop control)

- <F320: Droop gain>
- <F321: Frequency at 0% droop gain>
- <F322: Frequency at F320 droop gain>
- <F323: Droop deadband torque>
- <F324: Droop output filter>

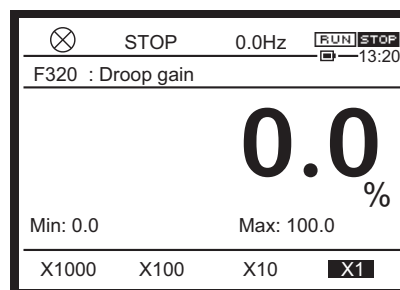

### ■ Function

Droop control is a function that prevents loads from concentrating at a specific motor due to load imbalance when multiple inverters and motors are used to drive a common load.

These parameters are used to allow the motor to slip (drooping characteristic) according to the load torque.

These parameters are used to adjust the frequency range, deadband torque, and gain.

6

### ■ Parameter setting

Title	Parameter name	Adjustment range	Unit	Default setting
F320	Droop gain	0.0 - 100.0 *1	%	0.0
F321	Frequency at 0% droop gain	0.0 - 320.0	Hz	10.0
F322	Frequency at F320 droop gain	0.0 - 320.0	Hz	100.0
F323	Droop deadband torque	0 - 100	%	10
F324	Droop output filter	0.1 - 200.0	rad/s	100.0

\*1 Range that can be changed during run is 0.1 - 100.0%. Setting or changing to 0.0 (no droop) must be performed after stop.

### ■ Setting methods

- Droop control is enabled when <Pt: V/f Pattern> is set to "3", "9", "10", or "11".
- When the applied torque is equal to or more than the deadband torque value, output frequency is reduced during power running or increased during regeneration.
- Droop control is enabled at frequency range <F321: Frequency at 0% droop gain> or more.
- The amount of droop will vary depending on the output frequency for frequency ranges <F321: Frequency at 0% droop gain> or more or <F322: Frequency at F320 droop gain> or less.
- For the frequency range over <vL: Base frequency 1>, the amount of error for <F323: Droop deadband torque> will increase. Therefore, we recommend you use this parameter at base frequency or less.
- Output frequency in droop control will not be limited by <FH: Maximum frequency>.

6

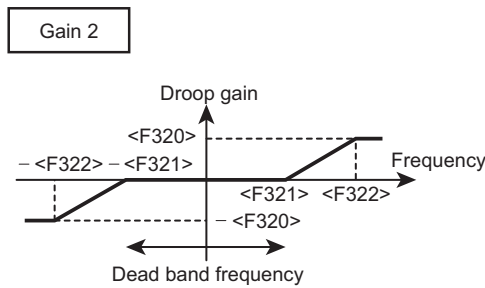
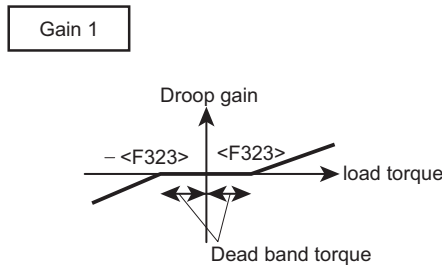

■ Calculating formula

The amount of output frequency adjusted by droop control can be calculated with the following formula.

1) Gain based on internal torque command (Gain 1)

- When internal torque command (%)  $\geq 0$ ,  

$$\text{Gain 1} = (\text{load torque} - \langle F323 \rangle) / 100$$
 Note that 0 (zero) or a positive number must be set to Gain 1.
- When internal torque command (%)  $< 0$ ,  

$$\text{Gain 1} = (\text{load torque} + \langle F323 \rangle) / 100$$
 Note that 0 (zero) or a negative number must be set to Gain 1.

2) Gain based on frequency after acceleration (Gain 2)

- When  $\langle F321 \rangle < \langle F322 \rangle$   
 When  $|\text{frequency after acceleration}| \leq \langle F321 \rangle$ ,  

$$\text{Gain 2} = 0$$
 When  $|\text{frequency after acceleration}| > \langle F322 \rangle$ ,  

$$\text{Gain 2} = \langle F320 \rangle / 100$$
 When  $\langle F321 \rangle < |\text{frequency after acceleration}| \leq \langle F322 \rangle$ ,  

$$\text{Gain 2} = (\langle F320 \rangle / 100) \times ( (|\text{frequency after acceleration}| - \langle F321 \rangle) / (\langle F322 \rangle - \langle F321 \rangle) )$$
- When  $\langle F321 \rangle \geq \langle F322 \rangle$   
 When  $|\text{frequency after acceleration}| \leq \langle F321 \rangle$ ,  

$$\text{Gain 2} = 0$$
 When  $|\text{frequency after acceleration}| > \langle F321 \rangle$ ,  

$$\text{Gain 2} = \langle F320 \rangle / 100$$



### 3) Droop frequency

Droop frequency = <vL: Base frequency 1> x Gain 1 x Gain 2

Note that, when <vL: Base frequency 1> is over 100 Hz, this value is calculated as 100 Hz.

#### Reference

- How to operate the operation panel -> Refer to [3. 1. 1].
- How to switch display mode on the operation panel -> Refer to [3. 1. 2].
- Procedure to change parameter setting -> Refer to [4. 2. 3]

## 6. 17 High-speed operation with light load on cranes

- <F328: Light-load high-speed operation>
- <F329: Light-load high-speed learning function>
- <F330: Light-load high-speed automatic operation frequency>
- <F331: Light-load high-speed operation switching lower-limit frequency>
- <F332: Light-load high-speed operation load detection wait time>
- <F333: Light-load high-speed operation load detection time>
- <F334: Light-load high-speed operation heavy load detection time>
- <F335: Switching load torque during power running>
- <F336: Heavy-load torque during power running>
- <F337: Heavy-load torque during constant speed power running>
- <F338: Switching load torque during regen>

For details, refer to "Crane Application Function Manual" (E6582104) (light-load high-speed operation, brake sequence, learning).

## 6. 18 Brake sequence

### 6. 18. 1 Brake sequence

- <F325: Brake release wait time>
- <F326: Brake release undercurrent threshold>
- <F340: Creep time 1>
- <F341: Brake function>
- <F342: Load torque input select>
- <F343: Hoisting torque bias>
- <F344: Lowering torque bias rate>
- <F345: Brake releasing time>
- <F346: Creep frequency>
- <F347: Creep time 2>
- <F348: Brake learning>
- <F630: Brake answer wait time>

For details, refer to "Crane Application Function Manual" (light-load high-speed operation, brake sequence, learning) (E6582104).

6

### 6. 18. 2 Hit and stop control

- <F382: Hit and stop control>
- <F383: Hit and stop frequency>
- <F384: Hit and stop torque limit>
- <F385: Hit and stop detection time>
- <F386: Hit and stop continuation torque limit>

For details, refer to Hit and Stop Function Instruction Manual ([E6582096](#)).

## 6. 19 Constant speed run with Acc/Dec suspended (dwell operation)

- <F349: Dwell operation>
- <F350: Acc suspended frequency>
- <F351: Acc suspended time>
- <F352: Dec suspended frequency>
- <F353: Dec suspended time>

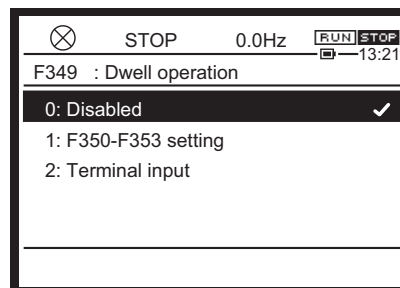

### ■ Function

This function suspends acceleration/deceleration temporarily and let the inverter run in constant speed according to the brake delay during run/stop for transportation of heavy load. This will prevent occurrence of overcurrent at startup or slippage when stopping by adjusting the timing with the brake.

There are two ways to set dwell operation: automatic stop by setting the stop frequency and stop time and stop by using signals to the input terminal.

### ■ Parameter setting

Title	Parameter name	Adjustment range	Unit	Default setting
F349	Dwell operation	0: Disabled 1: F350-F353 setting 2: Terminal input		0
F350	Acc suspended frequency	0.0 - FH	Hz	0.0
F351	Acc suspended time	0.0 - 10.0	s	0.0
F352	Dec suspended frequency	0.0 - FH	Hz	0.0
F353	Dec suspended time	0.0 - 10.0	s	0.0

### ■ Setting method

Select whether to automatically suspend acceleration/deceleration by parameter settings or by signal input to the input terminal. This is set with <F349: Dwell operation>.

- When <F349> is set to "1", you must also set parameters <F350: Acc suspended frequency> through <F353: Dec suspended time>.

<F350: Acc suspended frequency> must be set to a value over <F240: Start frequency>.

<F352: Dec suspended frequency> must be set to a value over <F243: End frequency>.

When the frequency command value is the same as values set for <F350> and <F352> settings, dwell operation will not be enabled.

- When <F349> is set to "2", you must also assign function numbers "60", "61" (dwell operation) to the unused input terminal.



Important

- When output frequency falls due to the stall preventive function, dwell operation may be enabled.

■ **Setting example: for automatic dwell operation**

Set <F350: Acc suspended frequency>, <F352: Dec suspended frequency>, <F351: Acc suspended time>, and <F353: Dec suspended time>. Then set <F349: Dwell operation> to "1".

When the output frequency reaches the set frequency, operation will automatically switch to constant speed run (acceleration/deceleration suspended).

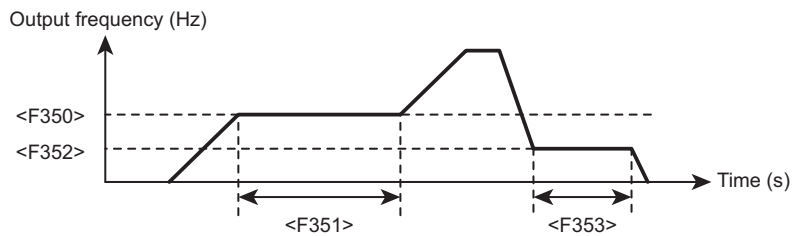

■ **Setting example: for dwell operation by external signal input**

Assign function numbers "60", "61" (dwell operation) to the unused input terminal. Dwell operation will be performed while the input terminal is ON.

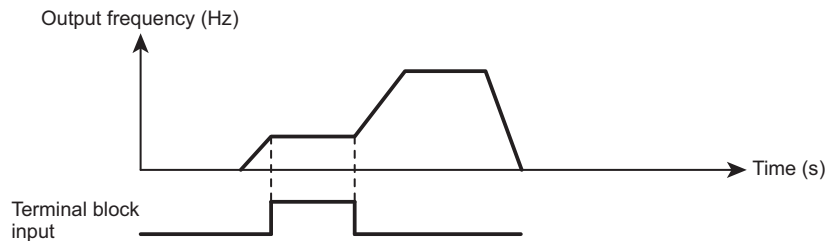

When you set run command ON after you set the dwell operation signal ON, operation will start at <F240: Start frequency>.

■ If the stall preventive function is enabled during dwell operation

Duration of any temporary output frequency change due to the stall preventive function will be included in the acceleration/deceleration suspended time.

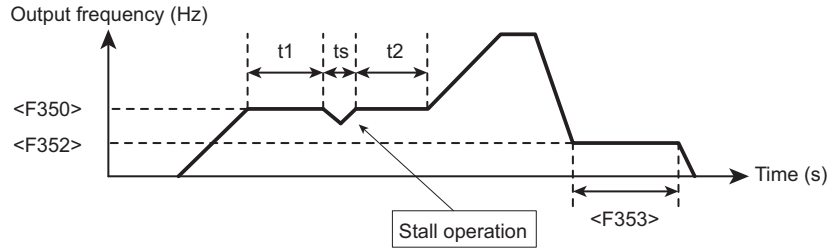

6

Memo

- The stall preventive function automatically changes the output frequency when overcurrent, overload or overvoltage occurs. Specific functions that are set with each parameter are as follows:
  - Overcurrent stall: <F601: Stall prevention level 1>
  - Overload stall: <OLM: Motor overload protection characteristic>
  - Overvoltage stall; <F305: Overvoltage limit operation>

Reference

- How to operate the operation panel -> Refer to [3. 1. 1].
- How to switch display mode on the operation panel -> Refer to [3. 1. 2].
- Procedure to change parameter setting -> Refer to [4. 2. 3]

## 6. 20 Switching to commercial power run

- <F354: Commercial power/Inverter switching>
- <F355: Commercial power switching frequency>
- <F356: Inverter switching wait time>
- <F357: Commercial power switching wait time>
- <F358: Commercial power switching frequency continuous time>

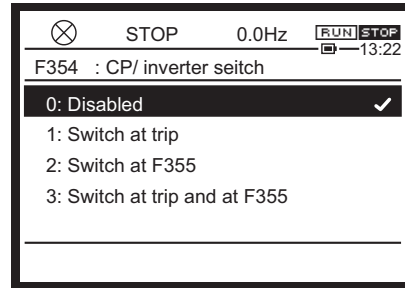

### ■ Function

This function allows output of switching signals to an external sequence (such as MC) so that when tripping occurs, operation will be switched to commercial power run without stopping the motor. For details, refer to Commercial power/Inverter switching (E6582108).

### ■ Parameter setting

Title	Parameter name	Adjustment range	Unit	Default setting
F354	Commercial power/ Inverter switching	0: Disabled 1: Switch at trip 2: Switch at F355 3: Switch at trip and at F355		0
F355	Commercial power switching frequency	0 - UL	Hz	50.0/60.0 *1
F356	Inverter switching wait time	0.10 - 10.00	s	*2
F357	Commercial power switching wait time	0.10 - 10.00	s	0.62
F358	Commercial power switching frequency continuous time	0.10 - 10.00	s	2.00

\*1 Depending on the setup menu. Refer to [5. 3. 10], [11. 10].

\*2 Depending on capacity. For details, refer to [11. 5].

Trips that are automatically switched are those not displayed as "OCL", "E", "EF1", and "EF2".

<F341: Brake function> will not be enabled.

■ Timing chart (setting example)

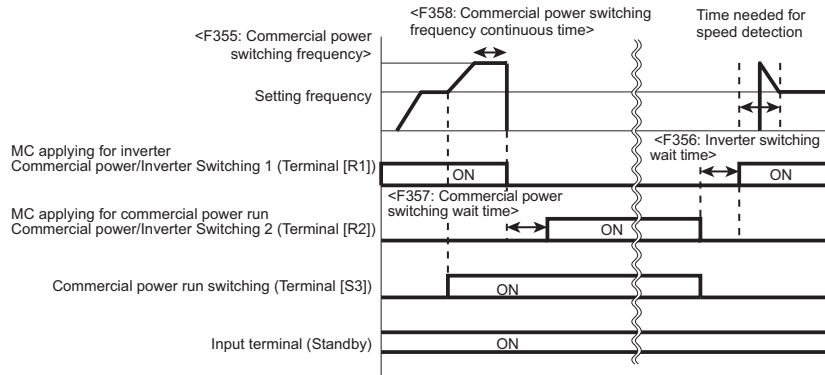

When function numbers "102", "103" (switch to commercial power run) is set to terminal [S3].

Terminal [S3] ON: commercial power operation

Terminal [S3] OFF: inverter operation

Switching cannot be performed properly if standby function is OFF.

6

Title	Parameter name	Setting example	Unit
F354	Commercial power/ Inverter switching	2: Switch at F355 or 3: Switch at trip and at F355	-
F355	Commercial power switching frequency	Power supply frequency, etc.	Hz
F356	Inverter switching wait time	Depending on capacity *1	s
F357	Commercial power switching wait time	0.62	s
F358	Commercial power switching frequency continuous time	2.00	s
F116	Terminal S3 function	102: Commercial powr run switching	-
F133	Terminal R1 function 1	46: Commercial power/Inverter Switching 1	-
F134	Terminal R2 function	48: Commercial power/Inverter Switching 2	-

\*1 Depending on capacity. For details, refer to [11. 6].



Important

- To allow switching to commercial power operation, forward run of the inverter and the direction of rotation of the motor for commercial power operation must match.
- Do not set <F311: Reverse inhibited> to "2: Fwd inhibited". The inverter will not be able to forward run and switching to commercial power cannot be accomplished.
- This function can only be used in induction motors. Do not use this function with PM motors.



**Reference**

- How to operate the operation panel -> Refer to [3. 1. 1].
- How to switch display mode on the operation panel -> Refer to [3. 1. 2].
- Procedure to change parameter setting -> Refer to [4. 2. 3]
- Details on operation by external signals -> Refer to [Chapter 7].

## 6. 21 PID control

<FPid: PID1 set value>  
<F359: PID control 1>  
<F360: PID1 feedback input select >  
<F361: PID1 filter>  
<F362: PID1 proportional gain>  
<F363: PID1 integral gain>  
<F364: PID1 deviation upper-limit>  
<F365: PID1 deviation lower-limit>  
<F366: PID1 differential gain>  
<F367: PID1 set value upper-limit>  
<F368: PID1 set value lower-limit>  
<F369: PID1 start wait time>  
<F370: PID1 output upper-limit>  
<F371: PID1 output lower-limit>  
<F372: PID1 set value increase time>  
<F373: PID1 set value decrease time>  
<F374: PID1 set value agreement detection band>  
<F388: PID1 output dead band>  
<F389: PID1 set value select>

6

For details of PID control, refer to PID Control Instruction Manual (E6582112).  
For parameter setting, refer to [5. 3. 8] "Setting PID control" as well.

## 6. 22 Retaining the stop position

<Pt: V/f Pattern>

<F381: Simple positioning completion range>

<F359: PID control1>

<F362: PID1 proportional gain>



<F369: PID1 start wait time>

<F375: PG pulses number>

<F376: PG phases number select>

For details of stop position retain function, refer to PID Control Instruction Manual (E6582112).

## 6. 23 Setting of motor parameters

 <b>WARNING</b>	
 Prohibited	<ul style="list-style-type: none"> <li>Do not touch terminals or motor of the inverter while performing auto tuning. Touching the terminals or motor while voltage is applied to the terminals and motor may result in electric shock, even if the motor is stopped. After setting offline auto-tuning (F400 = "2"), execute the auto tuning at first start of the inverter. The auto tuning takes several seconds and the motor is stopped meanwhile, but voltage is applied to the terminals and motor. The motor may also generate a sound during the auto tuning, but this is not malfunction.</li> </ul>
 Mandatory action	<ul style="list-style-type: none"> <li>Install circuit protection such as the mechanical brake in the crane. If there is no sufficient circuit protection installed in the crane, insufficient motor torque while auto tuning will cause the machine stalling/falling.</li> </ul>

### 6. 23. 1 Setting induction motor parameters

6

- <F400: Offline auto-tuning>
- <F401: Slip frequency gain>
- <F402: Automatic torque boost>
- <F403: Online auto-tuning>
- <F405: Motor rated capacity>
- <F412: Leakage inductance>
- <F413: Exciting current coefficient>
- <F414: Stall prevention coefficient>
- <F415: Motor rated current>
- <F416: Motor no load current>
- <F417: Motor rated speed>
- <F459: Load inertia ratio>
- <F462: Speed reference filter coefficient 1>
- <F465: Speed reference filter coefficient 2>

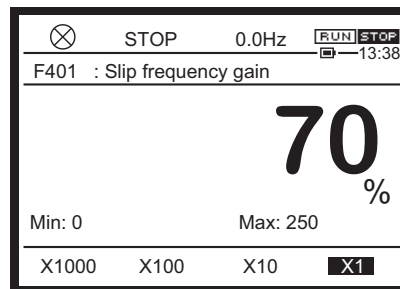
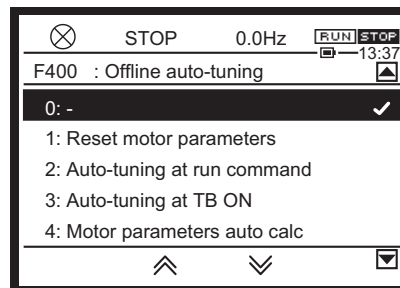

#### ■ Function

To select vector control, automatic torque boost, or automatic energy-saving with <Pt: V/f Pattern>, you must set motor parameters (auto-tuning).

There are four setting methods.

- Use <AU2: Torque boost macro> to set both <Pt> and <F400: Offline auto-tuning>.
- Set <Pt> and <F400> individually.
- Set <Pt> and <F400> individually. Perform an auto-tuning after calculating the motor parameter automatically (available with motor not connected).

- Set <Pt> and set the motor parameter manually.



Important

- Check the motor name plate and set the following parameters first.  
The value of 4 pole general purpose motor, with same capacity as the inverter, is set by default setting.
  - <vL: Base frequency 1> (Rated frequency)
  - <vLv: Base frequency voltage 1> (Rated voltage)
  - <F405: Motor rated capacity>
  - <F415: Motor rated current>
  - <F417: Motor rated speed>
- Set other motor parameters as necessary.

■ **Setting method 1: Use torque boost macro**

This is the simplest setting method. Vector control/automatic torque boost/automatic energy-saving and auto-tuning are all set at once.

Check the motor name plate and set the following parameters first.

- <vL: Base frequency 1> (Rated frequency)
- <vLv: Base frequency voltage 1> (Rated voltage)
- <F405: Motor rated capacity>
- <F415: Motor rated current>
- <F417: Motor rated speed>

Next, set <AU2: Torque boost macro>.

- 1: Automatic torque boost + offline auto-tuning
- 2: Vector control 1 + offline auto-tuning
- 3: Energy savings + offline auto-tuning

For details of setting methods, refer to [5. 3. 5].

■ **Setting method 2: Set auto-tuning**

Set vector control/automatic torque boost/automatic energy-saving and auto-tuning individually.

First, set <Pt: V/f Pattern>. For details of setting methods, refer to [5. 3. 4].

Next, perform offline auto-tuning.

**1) Parameter setting**

Title	Parameter name	Adjustment range	Default setting
F400	Offline auto-tuning	0: - 1: Reset motor parameters (0 after execution) 2: Auto-tuning at run command (0 after execution) 3: Auto-tuning at TB ON 4: Motor parameters auto calculation (0 after execution) 5: 4+2 (0 after execution) 6: Auto-tuning at run command during TB ON 7: Auto-tuning F402 only at run command during TB ON	0

## 2) Selecting auto-tuning setting

### 1: Reset motor parameters (0 after execution)

Set motor parameters <F402: Automatic torque boost>, <F412: Leakage inductance>, and <F416: Motor no load current> to default setting values (same motor parameter values as a 4 pole general purpose motor with same capacity as the inverter).

### 2: Auto-tuning at run command (0 after execution)

Perform auto-tuning when the motor starts for the first time after settings are made and automatically set <F402: Automatic torque boost> and <F412: Leakage inductance> while considering the motor wiring.

### 3: Auto-tuning at TB ON

Assign "66: Offline auto-tuning" (67 is the inversion signal) to the digital input terminal.

When the assigned input terminal is ON, make an auto-tuning and automatically set <F402: Automatic torque boost> and <F412: Leakage inductance>.

This setting allows auto-tuning while the motor is stopped; use this function when the motor cannot run following the auto-tuning due to some reason related to the operation of the machinery.

However, if standby signal is OFF, this function will not be enabled.

To make an auto-tuning again, turn input terminal off once, then turn on again.

### 6: Auto-tuning at run command during TB ON

Assign "66: Offline auto-tuning" (67 is the inversion signal) to the digital input terminal.

When the assigned input terminal is ON, always make an auto-tuning and automatically set <F402: Automatic torque boost> and <F412: Leakage inductance> at startup.

### 7: Auto-tuning F402 only at run command during TB ON

Assign "66: Offline auto-tuning" (67 is the inversion signal) to the digital input terminal.

Always make an auto-tuning at startup when the motor starts for the first time after the assigned input terminal is ON and set <F402: Automatic torque boost> only.

## 3) Cautions during offline auto-tuning

- Offline auto-tuning must be performed with the motor connected but in a completely stopped state.
  - Due to residual voltage, tuning may not be properly executed immediately after running motor is stopped.
- There would be almost no rotation of the motor during offline auto-tuning, but you must keep in mind that voltage is still applied during this time.
- During auto-offline tuning, "Atn" will be displayed on the LCD screen.
- Offline auto-tuning takes a few seconds. If any failure is found, tripping will occur with auto-tuning error "Etn1" or "Etn2", and motor parameters will not be set.
- Offline auto-tuning cannot be performed on special motors such as a high-speed motor or high-slip motor. Calculate the motor parameters using "Setting method 3".
- If offline auto-tuning cannot be executed or auto-tuning error "Etn1" or "Etn2" occurs, perform manual setting using "Setting method 4".

### ■ Setting method 3: Make auto-tuning of motor parameter after automatic setting.

Make auto-tuning after setting vector control/automatic torque boost/automatic energy-saving and performing motor parameters auto calculation.

Check the motor name plate and set the following parameters first.

- <vL: Base frequency 1> (Rated frequency)
- <vLv: Base frequency voltage 1> (Rated voltage)
- <F405: Motor rated capacity>
- <F415: Motor rated current>
- <F417: Motor rated speed>

Next, set <Pt: V/f Pattern>. For details of setting methods, refer to [5. 3. 4].

Then, select <F400> = "4: Motor parameters auto calculation (0 after execution)" and calculate motor parameters automatically.

Motor parameters <F402: Automatic torque boost>, <F412: Leakage inductance>, and <F416: Motor no load current> will be set automatically.

This setting can be made without connecting the motor since it only calculates.

After automatic setting of motor parameter with <F400> = "4", be sure to set <F400> to "2: Auto-tuning at run command (0 after execution)" and perform an auto-tuning.

You can set <F400> to "4" and "2" collectively by setting <F400> to "5: 4+2 (0 after execution)".

Since calculation is performed based on general trend, the calculation results may not be correct. In this case, set the parameter manually. In case ETN3 trip occurs after set 4 to F400, do not set 4 to F400, and set the parameter manually.

■ **Setting method 4: Manually setting motor parameter**

Set <Pt: V/f Pattern> and set the motor parameter manually.

If tuning error "Etn1" is displayed during auto-tuning setting or when you want to improve vector control characteristics, set motor parameters individually.

**4) Parameter setting**

Title	Parameter name	Adjustment range	Unit	Default setting
F401	Slip frequency gain	0 - 250	%	70
F402	Automatic torque boost	0.1 - 30.00	%	*1
F405	Motor rated capacity	0.01 - 315.0	kW	*1
F412	Leakage inductance	0.0 - 25.0	%	*1
F413	Exciting current coefficient	100 - 150	%	100
F415	Motor rated current	*1	A *1	*1
F416	Motor no load current	10 - 90	%	*1
F417	Motor rated speed	100 - 64000	min <sup>-1</sup>	*2
F459	Load inertia ratio	0.1 - 100.0	Times	1.0
F460	Speed control response 1	0.0 - 25.0	-	0.0
F461	Speed control stabilization coefficient 1	0.50 - 2.50	-	1.00
F462	Speed reference filter coefficient 1	0 - 100	-	35

Title	Parameter name	Adjustment range	Unit	Default setting
F463	Speed control response 2	0.0 - 25.0	-	0.0
F464	Speed control stabilization coefficient 2	0.50 - 2.50	-	1.00
F465	Speed reference filter coefficient 2	0 - 100	-	35
F466	Speed control response switching frequency	0.0 - FH	Hz	0.0

\*1 Depending on capacity. For details, refer to [11. 6].

\*2 Depending on the setup menu. Refer to [5. 3. 10], [11. 10].

## 5) Motor parameter setting method (Basic)

### <F401: Slip frequency gain>

This parameter sets the compensation gain for motor slip.

Increasing the value will reduce motor slip.

Set <F417: Motor rated speed> and then make fine adjustments to <F401>.

Keep in mind that setting a higher value than necessary will cause unstable operation such as hunting.

### <F402: Automatic torque boost>

This parameter adjusts the primary resistive component of the motor.

Increasing this value will prevent torque reduction due to voltage drop during low speed.

Adjust the value according to the actual operation.

Keep in mind that setting a higher value than necessary will increase current at low speed and may cause tripping.

If there is a motor test report, check the stator resistance value per phase.

$$\langle F402 \rangle (\%) = (\sqrt{3} \times R_s \times \langle F415 \rangle \times 0.9) / (V_{type} \times 100)$$

where  $R_s$  is the stator resistance value per phase ( $\Omega$ ),  $V_{type}$  is 200, 400 V (depends on voltage class).

### <F405: Motor rated capacity>

This parameter sets the motor rated capacity.

Check the motor name plate or test report while setting.

### <F412: Leakage inductance>

This parameter sets the leakage inductance component of the motor.

Increasing this value will improve torque in the high-speed region.

### <F415: Motor rated current>

This parameter sets the motor rated current.

Check the motor name plate or test report while setting.

### <F416: Motor no load current>

This parameter sets the ratio of the motor no-load current to the rated current.

This is equivalent to the exciting inductance of the motor.

Check the no-load current value in the motor test report and divide it by the rated current value.

Set the calculated value in %.



Increasing this value will increase the exciting current.  
Keep in mind that setting a value too high will cause hunting in the motor.

**<F417: Motor rated speed>**

This parameter sets the motor rated speed.  
Check the motor name plate or test report while setting.

**6) Motor parameter setting method (Advanced)**

• **How to adjust the moment of inertia of the load**

**<F459: Load inertia ratio>**

This parameter adjusts the excess response speed.  
Increasing this value will reduce the overshoot at the acceleration/deceleration completion point.

Default setting values are set so that the moment of inertia of the load (including the motor shaft) value is set to be appropriate at 100% of the motor shaft. If the moment of inertia of the load is not 100%, set a value appropriate for the actual inertia of the load.

**<F460: Speed control response 1>**

**<F461: Speed control stabilization coefficient 1>**

**<F462: Speed reference filter coefficient 1>**

**<F463: Speed control response 2>**

**<F464: Speed control stabilization coefficient 2>**

**<F465: Speed reference filter coefficient 2>**

**<F466: Speed control response switching frequency>**

This parameter adjusts the excess response speed.  
Increasing this value will reduce the overshoot at the acceleration/deceleration completion point. Set a value appropriate for the actual inertia of the load.  
For details, refer to "Current and Speed Control Gain Adjustment Method" manual (E6582136).

- If the torque needs to be increased in low speed range (10Hz or less as a guide)  
Perform the basic settings for the motor parameters. Then, if the torque needs to be increased even further, increase <F413: Exciting current coefficient> to a maximum of 130%. <F413> is a parameter that increases the magnetic flux of the motor at low speeds, so specifying a higher value for <F413> increases the no-load current. If the no-load current exceeds the rated current, do not adjust this parameter.
- If the motor stalls when operated at frequencies over the base frequency  
Adjust <F414: Stall prevention coefficient>.  
If a heavy load is applied momentarily (transiently), the motor may stall before the load current reaches the stall prevention level (<F601>, etc.). In such a case, a motor stall may be avoided by reducing the value of <F414> gradually.

**Memo**

- To use vector control, the motor capacity must be the same as the inverter rated capacity, or you can use a general purpose squirrel-cage motor with capacity no less than one rank below. Note that the minimum applicable motor capacity is 0.1 kW.

■ **Online auto-tuning setting**

<F403: Online auto-tuning> is a function that automatically adjusts motor parameters by predicting the increase in motor temperature.

- Online auto-tuning must be performed along with <F400: Offline auto-tuning>.
- Perform auto-tuning when the motor has cooled down (same temperature as the ambient temperature).

**7) Parameter setting**

Title	Parameter name	Adjustment range	Default setting
F403	Online auto-tuning	0: Disabled 1: Self-cooling motor auto-tuning 2: Forced air-cooling motor auto-tuning	0

**8) Selecting a setting value**

**1: Self-cooling motor auto-tuning**

Set this value when the motor is equipped with a self-cooling fan (a type in which a fan is directly connected to the motor shaft).

**2: Forced air-cooling motor auto-tuning**

Set this value when the motor is equipped with a fan motor (forced air-cooling).

**6**

<b>Reference</b>	<ul style="list-style-type: none"> <li>• How to operate the operation panel -&gt; Refer to [3. 1. 1].</li> <li>• How to switch display mode on the operation panel -&gt; Refer to [3. 1. 2].</li> <li>• Procedure to change parameter setting -&gt; Refer to [4. 2. 3]</li> </ul>
------------------	---

## 6. 23. 2 Setting PM motor parameters

- <F400: Offline auto-tuning>
- <F402: Automatic torque boost>
- <F405: Motor rated capacity>
- <F415: Motor rated current>
- <F417: Motor rated speed>
- <F459: Load inertia ratio>
- <F462: Speed reference filter coefficient 1>
- <F465: Speed reference filter coefficient 2>
- <F912: PM q-axis inductance>
- <F913: PM d-axis inductance>
- <F915: PM control method>

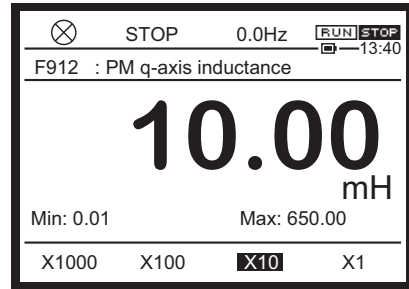

### ■ Function

To select PM motor control with <Pt: V/f Pattern>, you must set motor parameters (auto-tuning). There are three setting methods.

- Set <Pt> and <F400: Offline auto-tuning> individually.
- Set <Pt> and <F400> individually. Perform an auto-tuning after calculating the motor parameter automatically (available with motor not connected).
- Set <Pt> and set the motor parameter manually.

6



Important

- To set <Pt: V/f Pattern> to "6: PM motor control" or "12: PG feedback PM motor control", check the motor name plate and set the following parameters first.
  - <vL: Base frequency 1> (Rated frequency): calculate from back EMF
  - <vLv: Base frequency voltage 1> (Rated voltage): calculate from back EMF
  - <F405: Motor rated capacity>
  - <F415: Motor rated current>
  - <F417: Motor rated speed>
  - <F912: PM q-axis inductance>
  - <F913: PM d-axis inductance>

### ■ Setting method 1: Set auto-tuning

Set PM motor control and auto-tuning individually.

First, set <Pt: V/f Pattern> to "6: PM motor control". For details of setting methods, refer to [5. 3. 4].

Next, perform offline auto-tuning.

## 1) Parameter setting

Title	Parameter name	Adjustment range	Default setting
F400	Offline auto-tuning	0: - 1: Reset motor parameters (0 after execution) 2: Auto-tuning at run command (0 after execution) 3: Auto-tuning at TB ON 4: Motor parameters auto calculation (0 after execution) 5: - 6: Auto-tuning at run command during TB ON 7: Auto-tuning F402 only at run command during TB ON	0

## 2) How to select a setting value

### 1: Reset motor parameters (0 after execution)

Motor parameters <F402: Automatic torque boost>, <F912: PM q-axis inductance>, and <F913: PM d-axis inductance> are set with default setting values.

### 2: Auto-tuning at run command (0 after execution)

Perform tuning when the motor starts for the first time after settings are made and automatically set <F402: Automatic torque boost>, <F912: PM q-axis inductance>, and <F913: PM d-axis inductance> while considering the motor wiring.

### 3: Auto-tuning at TB ON

Assign "66: Offline auto-tuning" (67 is the inversion signal) to the digital input terminal. When the assigned input terminal is ON, executed an auto-tuning and automatically set <F402: Automatic torque boost>, <F912: PM q-axis inductance>, and <F913: PM d-axis inductance>. This setting allows auto-tuning while the motor is stopped; use this function when the motor cannot run following the auto-tuning due to some reason related to the operation of the machinery. However, if standby signal is OFF, this function will not be enabled. To make an auto-tuning again, tern input terminal off once, then turn on again.

### 6: Auto-tuning at run command during TB ON

Assign "66: Offline auto-tuning" (67 is the inversion signal) to the digital input terminal. When the assigned input terminal is ON, always make an auto-tuning and automatically set <F402: Automatic torque boost>, <F912: PM q-axis inductance>, and <F913: PM d-axis inductance> at startup.

### 7: Auto-tuning F402 only at run command during TB ON

Assign "66: Offline auto-tuning" (67 is the inversion signal) to the digital input terminal. Always execute an auto-tuning at startup when the motor starts for the first time after the assigned input terminal is ON and set <F402: Automatic torque boost> only.

## 3) Cautions during offline auto-tuning

- Offline auto-tuning must be performed with the motor connected but in a completely stopped state.

Due to residual voltage, auto-tuning may not be properly performed immediately after running motor is stopped.

- There would be almost no rotation of the motor during offline auto-tuning, but you must keep in mind that voltage is still applied during this time.
- During auto-offline tuning, "Atn" will be displayed on the LCD screen.
- Offline auto-tuning takes a few seconds. If any failure is found, tripping will occur with auto-tuning error "Etn1" or "Etn2", and motor parameters will not be set.
- Offline auto-tuning cannot be performed on special motors. Calculate the motor parameters using "Setting method 2".
- If offline auto-tuning cannot be performed or auto-tuning error "Etn1" or "Etn2" occurs, set manually using "Setting method 3".

■ **Setting method 2: Make auto-tuning of motor parameter after automatic setting.**

Set PM motor control and then perform motor parameters auto calculation.

Check the motor name plate and set the following parameters first.

- <vL: Base frequency 1> (Rated frequency)
- <vLv: Base frequency voltage 1> (Rated voltage)
- <F405: Motor rated capacity>
- <F415: Motor rated current>
- <F417: Motor rated speed>

Next, set <Pt: V/f Pattern> to "6: PM motor control". For details of setting methods, refer to [5. 3. 4]. Then, select <F400> = "4: Motor parameters auto calculation (0 after execution)" and perform <vLv: Base frequency voltage> auto calculation.

This setting can be made without connecting the motor since it only calculates.

After automatic setting of motor parameter with <F400> = "4", be sure to set <F400> to "2: Auto-tuning at run command (0 after execution)" and execute an auto-tuning.

Since calculation is performed based on general trend, the calculation results may not be correct. In this case, set the parameter manually.

■ **Setting method 3: Manually setting motor parameter**

Set <Pt: V/f Pattern> to "6: PM motor control" and set the motor parameter manually.

If tuning error "Etn1" is displayed during auto-tuning setting or when you want to improve PM motor control characteristics, set motor parameters individually. For details of setting methods, refer to [5. 3. 4].

**4) Parameter setting**

Title	Parameter name	Adjustment range	Unit	Default setting
F402	Automatic torque boost	0.1 - 30.00	%	*1
F405	Motor rated capacity	0.01 - 315.0	kW	*1
F415	Motor rated current	*1	A *1	*1
F417	Motor rated speed	100 - 64000	min <sup>-1</sup>	*2
F459	Load inertia ratio	0.1 - 100.0	Times	1.0
F460	Speed control response 1	0.0 - 25.0	-	0.0

Title	Parameter name	Adjustment range	Unit	Default setting
F461	Speed control stabilization coefficient 1	0.50 - 2.50	-	1.00
F462	Speed reference filter coefficient 1	0 - 100	-	35
F463	Speed control response 2	0.0 - 25.0	-	0.0
F464	Speed control stabilization coefficient 2	0.50 - 2.50	-	1.00
F465	Speed reference filter coefficient 2	0 - 100	-	35
F466	Speed control response switching frequency	0.0 - FH	Hz	0.0
F912	PM q-axis inductance	0.01 - 650.00	mH	10.00
F913	PM d-axis inductance	0.01 - 650.00	mH	10.00

\*1 Depending on capacity. For details, refer to [11. 6].

\*2 Depending on the setup menu. Refer to [5. 3. 10], [11. 10].

## 6

## 5) Motor parameter setting method

### <F402: Automatic torque boost>

This parameter adjusts the primary resistive component of the motor.

Increasing this value will prevent torque reduction due to voltage drop during low speed.

Adjust the value according to the actual operation. Keep in mind that setting a higher value than necessary will increase current at low speed and may cause tripping.

If there is a motor test report, check the stator resistance value per phase.

$$\text{<F402> (\%)} = (\sqrt{3} \times R_s \times \text{<F415>} \times 0.9) / (V_{\text{type}} \times 100)$$

where  $R_s$  is the stator resistance value per phase ( $\Omega$ ),  $V_{\text{type}}$  is 200, 400 V (depends on voltage class).

### <F405: Motor rated capacity>

This parameter sets the motor rated capacity.

Check the motor name plate or test report while setting.

### <F415: Motor rated current>

This parameter sets the motor rated current.

Check the motor name plate or test report while setting.

### <F417: Motor rated speed>

This parameter sets the motor rated speed.

Check the motor name plate or test report while setting.

## How to adjust the moment of inertia of the load

### <F459: Load inertia ratio>

This parameter adjusts the excess response speed.

Increasing this value will reduce the overshoot at the acceleration/deceleration completion point.

Default setting values are set so that the moment of inertia of the load (including the motor shaft) value is set to be appropriate at 100% of the motor shaft. If the moment of inertia of the load is not 100%, set a value appropriate for the actual moment of inertia of the load.

- <F460: Speed control response 1>
- <F461: Speed control stabilization coefficient 1>
- <F462: Speed reference filter coefficient 1>
- <F463: Speed control response 2>
- <F464: Speed control stabilization coefficient 2>
- <F465: Speed reference filter coefficient 2>
- <F466: Speed control response switching frequency>

This parameter adjusts the excess response speed. Increasing this value will reduce the overshoot at the acceleration/deceleration completion point. Set a value appropriate for the actual moment of inertia of the load. For details, refer to "Current and Speed Control Gain Adjustment Method" manual (E6582136).

- <F912: PM q-axis inductance>
  - <F913: PM d-axis inductance>
- Set q-axis inductance and d-axis inductance (mH) of PM motor. Use <F400: auto-tuning> to set the value.

<b>Memo</b>	<ul style="list-style-type: none"> <li>• To use PM motor control, the motor capacity must be the same as the inverter rated capacity, or you can use a motor with capacity no less than one rank below.</li> <li>• If there is a possibility that main power supply is shut down during running, set &lt;F301: Auto-restart&gt; to activate. Otherwise, when DC-bus voltage is recovered and inverter start to run again, E-39 or OP trip occurs, because motor is still rotated and back EMF voltage is high.</li> </ul>
-------------	---

■ **PM motor control and starting torque optimization setting**

If the PM motor does not start after auto-tuning due to heavy load, set <F915: PM control method> to "4" for starting torque optimization.

**6) Parameter setting**

Title	Parameter name	Adjustment range	Default setting
F915	PM control method	0: Method 0 1: Method 1 2: Method 2 3: Method 3 4: Method 4	3

**7) How to select setting values**

**0: Method 0**

This value sets no initial position estimation control. Reverse run may occur at startup. If tripping occurs with PM auto-tuning error "E-39", use this function by setting <F915> to "0".

**1: Method 1**

This value sets initial position estimation for high saliency motors.

**2: Method 2**

This value sets initial position estimation and starting torque optimization for high saliency motors.

**3: Method 3**

This value sets initial position estimation for weak saliency motors.

**4: Method 4**

This value sets initial position estimation and starting torque optimization for weak saliency motors.

**Reference**

- How to operate the operation panel -> Refer to [3. 1. 1].
- How to switch display mode on the operation panel -> Refer to [3. 1. 2].
- Procedure to change parameter setting -> Refer to [4. 2. 3]



## 6. 24 Torque limits

### 6. 24. 1 Switching torque limits

- <F440: Power running torque limit input select 1>
- <F441: Power running torque limit level 1>
- <F442: Regenerative torque limit input select 1>
- <F443: Regenerative torque limit level 1>
- <F444: Power running torque limit level 2>
- <F445: Regenerative torque limit level 2>
- <F446: Power running torque limit level 3>
- <F447: Regenerative torque limit level 3>
- <F448: Power running torque limit level 4>
- <F449: Regenerative torque limit level 4>
- <F454: Torque limit in field weakening>

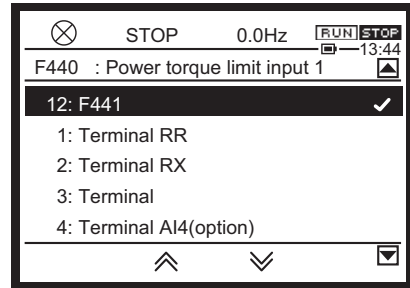

#### ■ Function

When the motor-generated torque reaches a certain level, the inverter reduce the torque by lowering the output frequency.

You can select a constant output limit or a constant torque limit in the constant output zone.

#### ■ Selecting a setting value

##### 1) When torque limits are applied by the parameter setting values

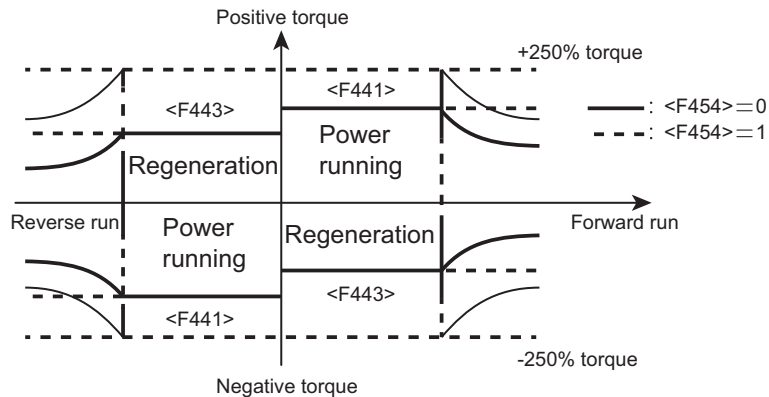

Select from where to input a torque limit value at <F440: Power running torque limit input select 1> and <F442: Regenerative torque limit input select 1>.

As default setting, torque limits are applied by the parameter setting values.

Title	Parameter name	Adjustment range	Default setting
F440	Power running torque limit input select 1	0: - 1: Terminal RR 2: Terminal RX 3: Terminal II 4: Terminal AI4 (option) 5 - 11: - 12: F441	12
F442	Regenerative torque limit input select 1	0: - 1: Terminal RR 2: Terminal RX 3: Terminal II 4: Terminal AI4 (option) 5 - 11: - 12: F443	12

Set the torque limit values for the power running and regenerative torques at <F441: Power running torque limit level 1> and <F443: Regenerative torque limit level 1>.

Set limit treatment of the constant output zone (weak magnetic field) at <F454: Torque limit in field weakening>. You can select either constant output limit <F454> = "0" (default setting) or constant torque limit <F454> ="1".

**6**

Title	Parameter name	Adjustment range	Unit	Default setting
F441	Power running torque limit level 1	0.0-249.9 250.0: Disabled	%	250.0
F443	Regenerative torque limit level 1	0.0-249.9 250.0: Disabled	%	250.0
F454	Torque limit in field weakening	0: Constant power limit 1: Constant torque limit		0

You can set four patterns each for the power running torque limit or the regenerative torque limit at the parameter settings.

Title	Parameter name	Adjustment range	Unit	Default setting
F444	Power running torque limit level 2	0.0-249.9 250.0: Disabled	%	250.0
F445	Regenerative torque limit level 2		%	250.0
F446	Power running torque limit level 3		%	250.0
F447	Regenerative torque limit level 3		%	250.0
F448	Power running torque limit level 4		%	250.0
F449	Regenerative torque limit level 4		%	250.0

Patterns 1 to 4 can be switched by turning the input terminal ON/OFF.

Assign "32: Stall prevention switching/Torque limit switching 1" and "34: Torque limit switching 2" to the two unused input terminals.

	32: Stall prevention switching/ Torque limit switching 1	34: Torque limit switching 2
Torque limit level 1	OFF	OFF
Torque limit level 2	ON	OFF
Torque limit level 3	OFF	ON
Torque limit level 4	ON	ON

**Memo**

- Set the torque limit level to "250.0" when disabling this function.
- When <Pt: V/f Pattern>="0", "1", or "7", the torque limit will be disabled.
- When the current value is big, or the setting value of <F601: Stall prevention level 1> is small, the stall preventive function may be active before torque limit and lower the frequency.

**2) When torque limits are applied by external signals**

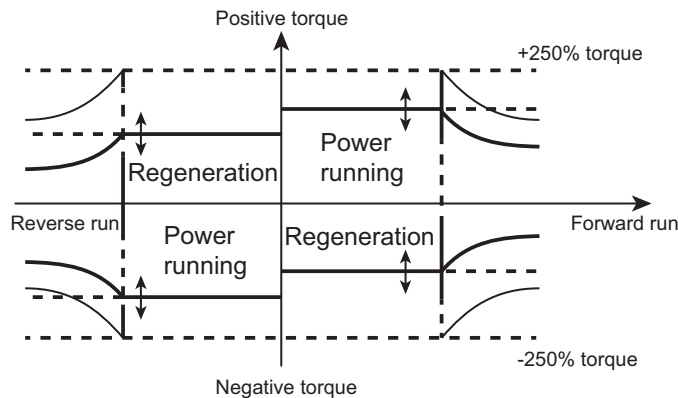

Torque limit value can be changed by external signals.

- When setting with input of 0 to 10 Vdc to terminal [RR]  
Set "1" for <F440: Power running torque limit input select 1> and <F442: Regenerative torque limit input select 1>.
- When setting with input of -10 to 10 Vdc to terminal [RX]  
Set "2" for <F440: Power running torque limit input select 1> and <F442: Regenerative torque limit input select 1>.
- When setting with input of 4 to 20 mAdc to terminal [II]  
Set "3" for <F440: Power running torque limit input select 1> and <F442: Regenerative torque limit input select 1>.

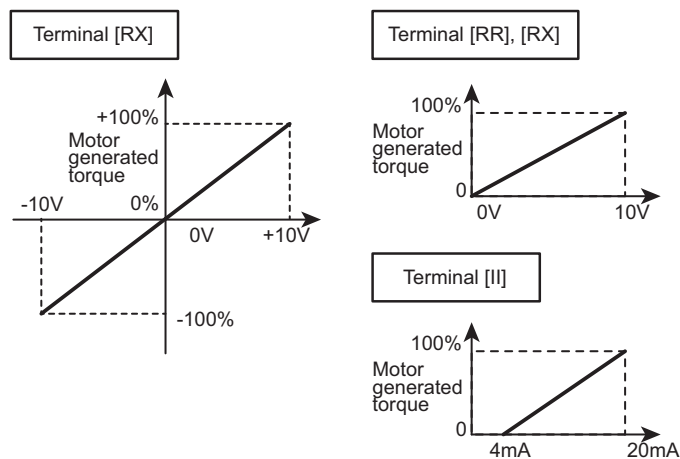

6

**Memo**

- The torque command values are limited to the torque limit level in torque control.
- When V/f Pattern is "V/f constant", "Variable torque", and "V/f 5-points", the torque limit will be disabled.

**Reference**

- How to operate the operation panel -> Refer to [3. 1. 1].
- How to switch display mode on the operation panel -> Refer to [3. 1. 2].
- Procedure to change parameter setting -> Refer to [4. 2. 3]
- Details on operation by external signals -> Refer to [Chapter 7].

## 6. 24. 2 Selecting Acc/Dec operation after stall prevention operation

<F451: Acc/Dec operation after stall operation>

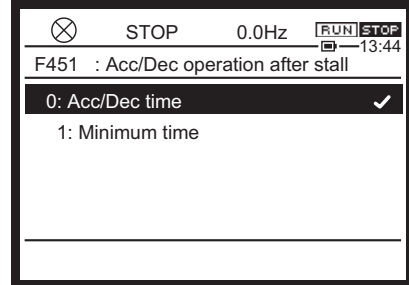

### ■ Function

When you use lifting gear (crane or hoist) in combination with mechanical brakes, and if the output frequency is decreasing due to stall prevention operation before mechanical brake release, accelerate the mechanical brake delay time in the minimum time to prevent load from falling due to torque reduction after mechanical brake release.

This will also improve the response in inching operation, and thus preventing the load from slipping down.

6

### ■ Parameter setting

Title	Parameter name	Adjustment range	Default setting
F451	Acc/Dec operation after stall operation	0: Acc/Dec time 1: Minimum time	0

### ■ Selecting a setting value

#### 0: Acc/Dec time

When stall prevention is active, the output frequency gets low.

If stall prevention was active and the output frequency is decreasing before releasing the machine, even if the mechanical brake is released, the stall prevention remains active during the delay time of the brake operation. After delay time of the brake operation, the output current value gets low, the stall prevention operation is deactivated and the output frequency increases.

With this setting, the output frequency reaches the frequency command value after brake operation delay time + acceleration time. The actual speed of the machinery changes in sync with the output frequency.

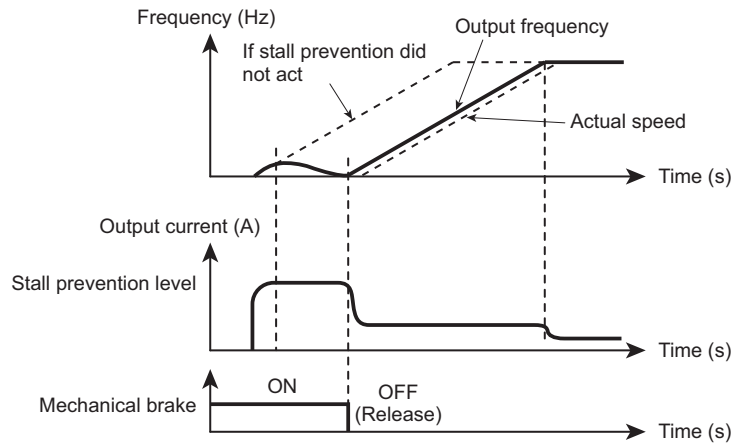

**1: Minimum time**

With the same situation as in 0, the output frequency precedes and accelerates in minimum time, even when the stall prevention is active. After release of the mechanical brake, the output current is retained, and the actual speed of the machinery changes in sync with the output frequency. This setting can prevent the load from falling, thus improving the response of the inching operation.

6

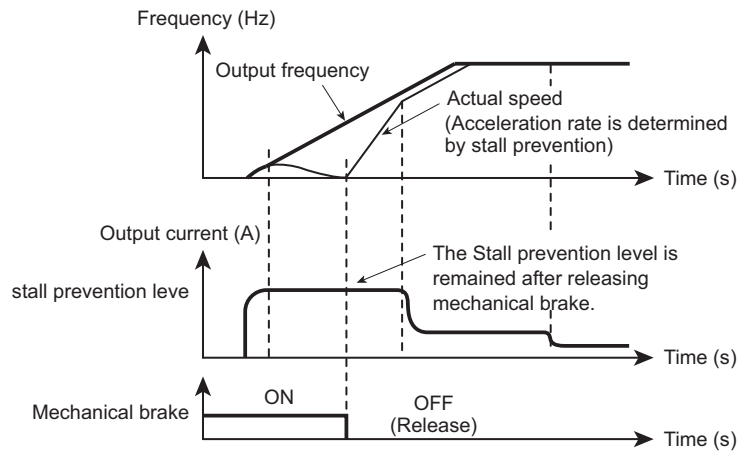

**Reference**

- How to operate the operation panel -> Refer to [3. 1. 1].
- How to switch display mode on the operation panel -> Refer to [3. 1. 2].
- Procedure to change parameter setting -> Refer to [4. 2. 3]

### 6. 24. 3 Detecting the stall time during power running to trip

- <F452: Stall detection time during power running>
- <F441: Power running torque limit level 1>
- <F601: Stall prevention level 1>

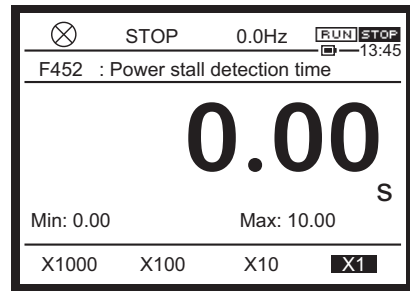

■ **Function**

This function is one of the functions to prevent lifting gear from falling. If stall prevention operation occurs in succession, this function judges that the motor has stalled to trip it.

■ **Parameter setting**

Title	Parameter name	Adjustment range	Unit	Default setting
F452	Stall detection time during power running	0.00-10.00	s	0.00
F441	Power running torque limit level 1	0.0-249.9 250.0: Disabled	%	250.0
F601	Stall prevention level 1	10-200 (HD) 10-160 (ND)	%	150(HD) 120(ND)

6

■ **Setting method**

1) **In case of overcurrent stall**

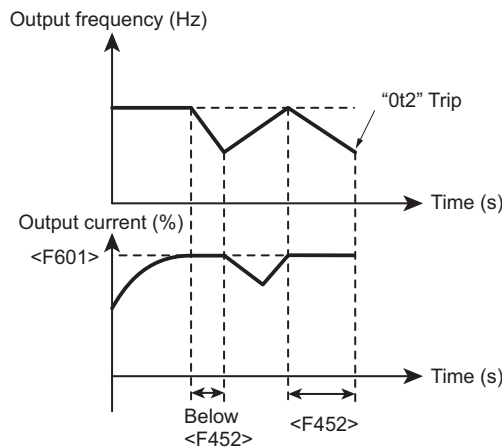

If, during power running, the output current reaches the value for <F601: Stall prevention level 1> or more, and continues for the period of time set for <F452: Stall detection time during power running>, the trip "Ot2" will occur.

## 2) In case of torque limit

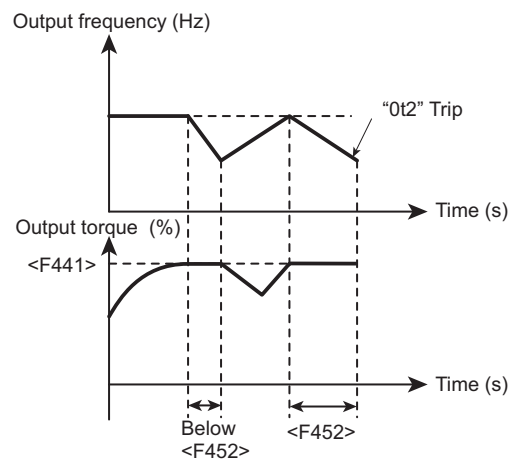

If, during power running, the output torque reaches the value for <F441: Power running torque limit level 1> or more, and continues for the period of time set for <F452: Stall detection time during power running>, the trip "Ot2" will occur. In case F452=0, this function is not activated (Ot2 trip does not occur).

6

## Reference

- How to operate the operation panel -> Refer to [3. 1. 1].
- How to switch display mode on the operation panel -> Refer to [3. 1. 2].
- Procedure to change parameter setting -> Refer to [4. 2. 3]



## 6. 24. 4 Selecting stall operation during regeneration

<F453: Stall operation during regen>

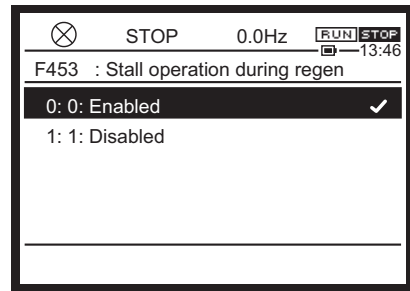

### ■ Function

This function is one of the functions to prevent the lifting gear from being displaced at stop. If current stall prevention gets active during regeneration of controlled stop, there may be a mismatch at stop. Set to inhibit only the stall prevention of current.

### ■ Parameter setting

Title	Parameter name	Adjustment range	Default setting
F453	Stall operation during regen	0: Enabled 1: Disabled	0

6

### ■ Selecting a setting value

To inhibit the stall prevention of current during regeneration of controlled stop, set <F453: Stall operation during regen> to "1".

#### Reference

- How to operate the operation panel -> Refer to [3. 1. 1].
- How to switch display mode on the operation panel -> Refer to [3. 1. 2].
- Procedure to change parameter setting -> Refer to [4. 2. 3]

## 6. 25 Torque control

For details of switching to torque control, refer to Torque control (E6582106).

### 6. 25. 1 Setting external torque commands

- <F420: Torque command select>
- <F421: Torque command filter>
- <F435: Rotation direction limit during torque control>
- <F455: Torque command polarity at Rev>
- <F725: Panel torque command>

### 6. 25. 2 Speed limit during torque control

- <F425: Fwd speed limit input>
- <F426: Fwd speed limit level>
- <F427: Rev speed limit input>
- <F428: Rev speed limit level>
- <F430: Speed limit center value input select>
- <F431: Speed limit center value>
- <F432: Speed limit band>

### 6. 25. 3 Selecting tension control torque bias input and load sharing gain input

- <F423: Tension control torque bias input>
- <F424: Load sharing gain input>
- <F727: Panel tension torque bias>
- <F728: Panel load sharing gain>

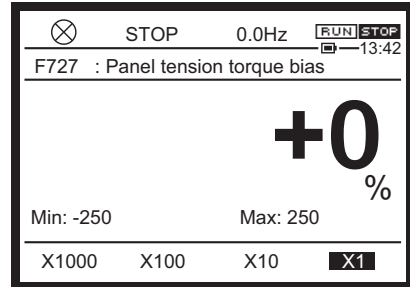

■ **Function**

These parameters are used to select tension control torque bias input and load sharing gain input.

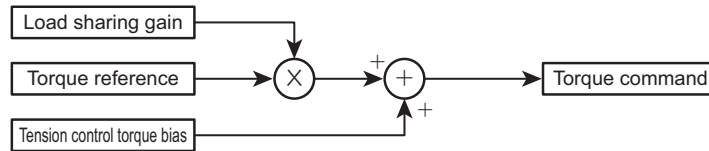

■ **Parameter setting**

Title	Parameter name	Adjustment range	Unit	Default setting
F423	Tension control torque bias input	0: - 1: Terminal RR 2: Terminal RX 3: Terminal II 4: Terminal AI4 (option) 5 - 11: - 12: F727 13 - 19: - 20: Embedded Ethernet 21: RS485 communication connector 1 22: RS485 communication connector 2 23: Communication option		0
F424	Load sharing gain input	0: - 1: Terminal RR 2: Terminal RX 3: Terminal II 4: Terminal AI4 (option) 5 - 11: - 12: F728 13 - 19: - 20: Embedded Ethernet 21: RS485 communication connector 1 22: RS485 communication connector 2 23: Communication option		0
F727	Panel tension torque bias	-250 to +250	%	0
F728	Panel load sharing gain	0 - 250	%	100

### ■ Setting example

Select destination of tension control torque bias input and load sharing gain input.

#### **When setting with input of 0 to 10 Vdc to terminal [RR]**

Set <F423: Tension control torque bias input> = "1" or <F424: Load sharing gain input> = "1".

#### **When setting with input of -10 to +10 Vdc to terminal [RX]**

Set <F423: Tension control torque bias input> = "2" or <F424: Load sharing gain input> = "2".

#### **When setting with input of 4 to 20 mAdc to terminal [II]**

Set <F423: Tension control torque bias input> = "3" or <F424: Load sharing gain input> = "3".

#### Reference

- How to operate the operation panel -> Refer to [3. 1. 1].
- How to switch display mode on the operation panel -> Refer to [3. 1. 2].
- Procedure to change parameter setting -> Refer to [4. 2. 3]
- Details on operation by external signals -> Refer to [Chapter 7].

## 6. 26 Adjusting current and speed control gain

### 6. 26. 1 Setting current and speed control gain

- <F458: Current control response>
- <F459: Load inertia ratio>
- <F460: Speed control response 1>
- <F461: Speed control stabilization coefficient 1>
- <F462: Speed reference filter coefficient 1>
- <F463: Speed control response 2>
- <F464: Speed control stabilization coefficient 2>
- <F465: Speed reference filter coefficient 2>
- <F466: Speed control response switching frequency>

For details, refer to "Current and Speed Control Gain Adjustment Method" manual (E6582136).

### 6. 26. 2 Setting the over modulation ratio

- <F495: Over modulation ratio>

## 6. 27 Switching multiple acceleration/ deceleration

### 6. 27. 1 Setting Acc/Dec patterns

- <F502: Acc/Dec pattern 1>
- <F506: S-Pattern range at Acc start>
- <F507: S-Pattern range at Acc completion>
- <F508: S-Pattern range at Dec completion>
- <F509: S-Pattern range at Dec start>

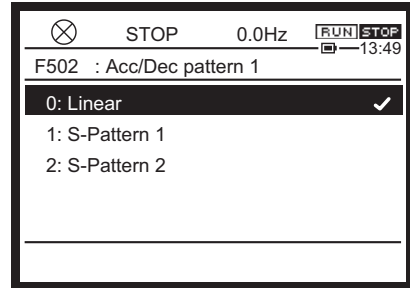

#### ■ Function

You can select acceleration/deceleration patterns suitable for the purpose.

#### ■ Parameter setting

Title	Parameter name	Adjustment range	Unit	Default setting
F502	Acc/Dec pattern 1	0: Linear 1: S-Pattern 1 2: S-Pattern 2		0
F506	S-Pattern range at Acc start	0-50	%	10
F507	S-Pattern range at Acc completion	0-50	%	10
F508	S-Pattern range at Dec completion	0-50	%	10
F509	S-Pattern range at Dec start	0-50	%	10

#### ■ How to select the setting value for <F502>

##### 0: Linear pattern

This is linear acceleration and deceleration, and is a normal Acc/Dec pattern. Normally, you can use this setting for operation.

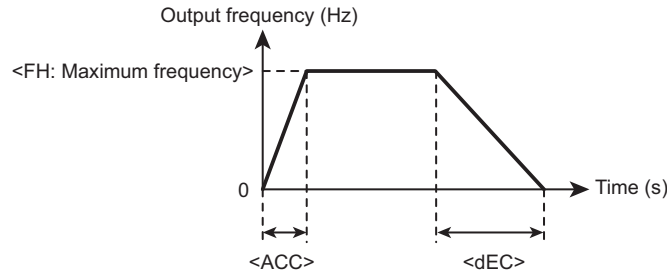

**1: S-Pattern 1**

The S-Pattern Acc/Dec 1 is selected to minimize the shock at acceleration/deceleration. This is suitable for pneumatic transport machines, etc.

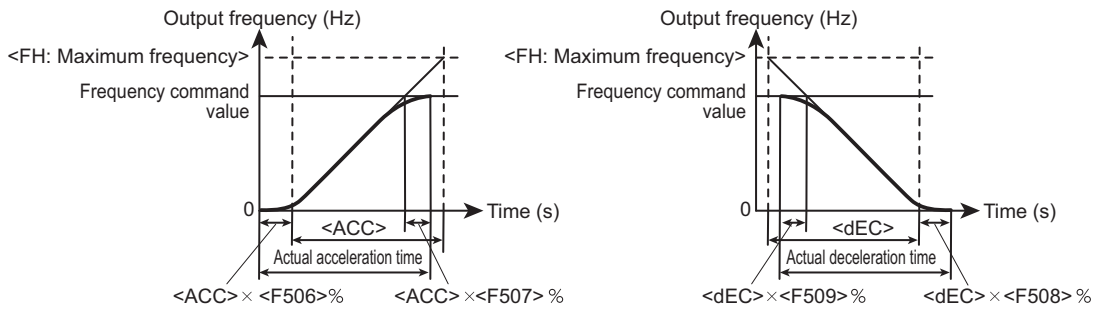

6

**2: S-Pattern 2**

For the S-Pattern ACC/DEC 2, the motor accelerating torque accelerates in the small demagnetizing region. This is suitable for high-speed spindle operation, etc.

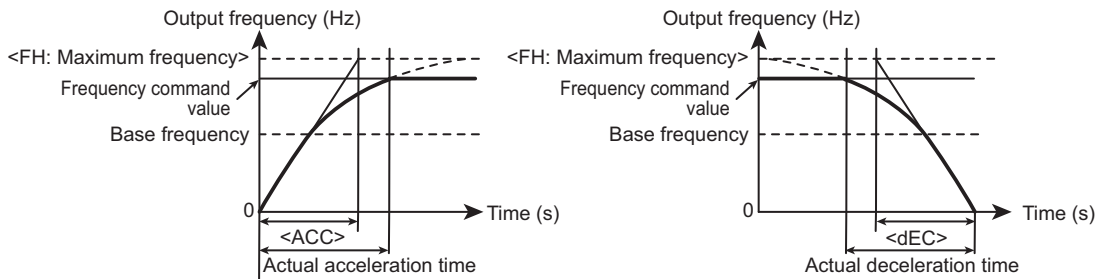

Reference

- How to operate the operation panel -> Refer to [3. 1. 1].
- How to switch display mode on the operation panel -> Refer to [3. 1. 2].
- Procedure to change parameter setting -> Refer to [4. 2. 3]

## 6. 27. 2 Switching four types of acceleration/deceleration

- <F500: Acceleration time 2>
- <F501: Deceleration time 2>
- <F503: Acc/Dec pattern 2>
- <F504: Panel Acc/Dec select>
- <F505: Acc/Dec switching frequency 1>
- <F510: Acceleration time 3>
- <F511: Deceleration time 3>
- <F512: Acc/Dec pattern 3>
- <F513: Acc/Dec switching frequency 2>
- <F514: Acceleration time 4>
- <F515: Deceleration time 4>
- <F516: Acc/Dec pattern 4>
- <F517: Acc/Dec switching frequency 3>
- <F519: Unit of Acc/Dec time>

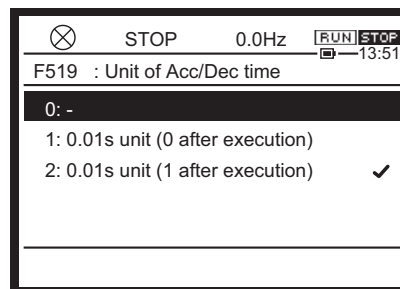
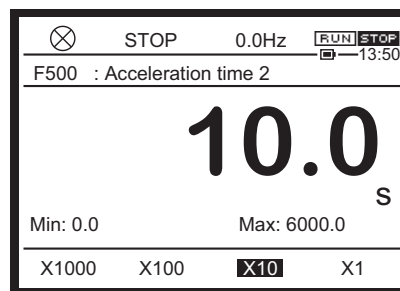

6

### ■ Function

You can set four types of options for each acceleration and deceleration time. There are three setting methods to choose from four types.

- 1) Selection by the parameters
- 2) Switching by frequencies
- 3) Switching by the terminals

### ■ Setting of parameters

Title	Parameter name	Adjustment range	Unit	Default setting
ACC	Acceleration time 1	0.0 - 6000 (600.0)	s	*1
dEC	Deceleration time 1	0.0 - 6000 (600.0)	s	*1
F500	Acceleration time 2	0.0 - 6000 (600.0)	s	*1
F501	Deceleration time 2	0.0 - 6000 (600.0)	s	*1
F510	Acceleration time 3	0.0 - 6000 (600.0)	s	*1
F511	Deceleration time 3	0.0 - 6000 (600.0)	s	*1
F514	Acceleration time 4	0.0 - 6000 (600.0)	s	*1
F515	Deceleration time 4	0.0 - 6000 (600.0)	s	*1
F519	Unit of Acc/Dec time	0: - 1: 0.01 s unit (0 after execution) 2: 0.1 s unit (0 after execution)	-	0

\*1 Depending on capacity. For details, refer to [11. 6].



In default setting, the acceleration/deceleration time is set in the increment unit of 0.1 second. When you set <F519: Unit of Acc/Dec time> to "1", you can change the increment unit for the acceleration/deceleration time to 0.01 second. (After setting <F519>, the unit returns to 0.)

■ How to use the parameters

1) Selection by the parameters

Title	Parameter name	Adjustment range	Unit	Default setting
F504	Panel Acc/Dec select	1: Acc/Dec 1 2: Acc/Dec 2 3: Acc/Dec 3 4: Acc/Dec 4		1

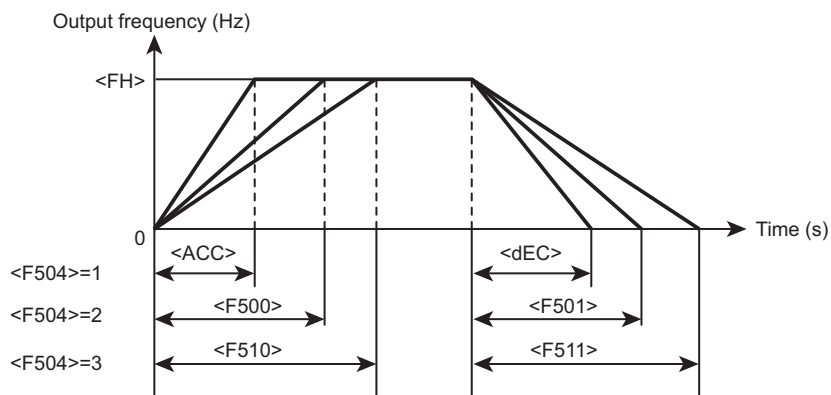

Set run command to panel run. Set <CMOd: Run command select> to "1: Operation panel, Extension panel".

At default setting, "Acc/Dec 1" is set, and <ACC: Acceleration time 1> and <dEC: Deceleration time 1> is enabled.

When using "Acc/Dec 2" to "Acc/Dec 4", set <F504: Panel Acc/Dec select>.

2) Switching by frequencies

Title	Parameter name	Adjustment range	Unit	Default setting
F505	Acc/Dec switching frequency 1	0.0: Disabled 0.1-UL	Hz	0.0
F513	Acc/Dec switching frequency 2	0.0: Disabled 0.1-UL	Hz	0.0
F517	Acc/Dec switching frequency 3	0.0: Disabled 0.1-UL	Hz	0.0

The acceleration/deceleration time is automatically switched according to the set frequency. Even if the order of the switching frequencies is changed, it will be switched between Acc/Dec 1 and 2, Acc/Dec 2 and 3, and then Acc/Dec 3 and 4 in the order of the increasing frequencies. For example, if <F505: Acc/Dec switching frequency 1> is higher than <F513: Acc/Dec switching frequency 2>, Acc/Dec 1 is selected to <F513>, and Acc/Dec 2 to <F505>.

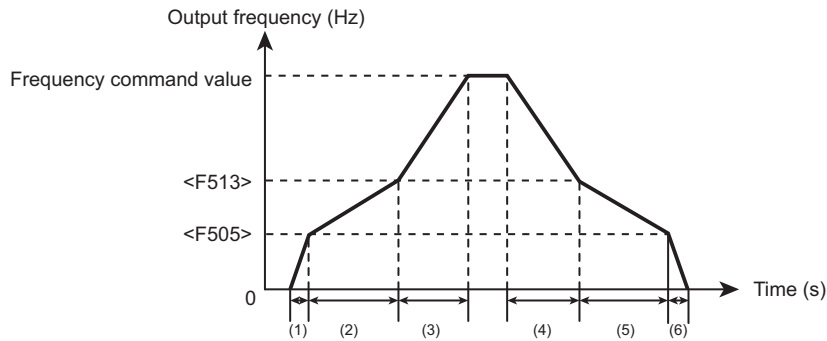

- (1) Accelerate by the inclination of the acceleration time <ACC>
- (2) Accelerate by the inclination of the acceleration time <F500>
- (3) Accelerate by the inclination of the acceleration time <F510>
- (4) Decelerate by the inclination of the deceleration time <F511>
- (5) Decelerate by the inclination of the deceleration time <F501>
- (6) Decelerate by the inclination of the deceleration time <dEC>

### 3) Switching by the terminals

The acceleration/deceleration time is switched by signals to terminals.

6

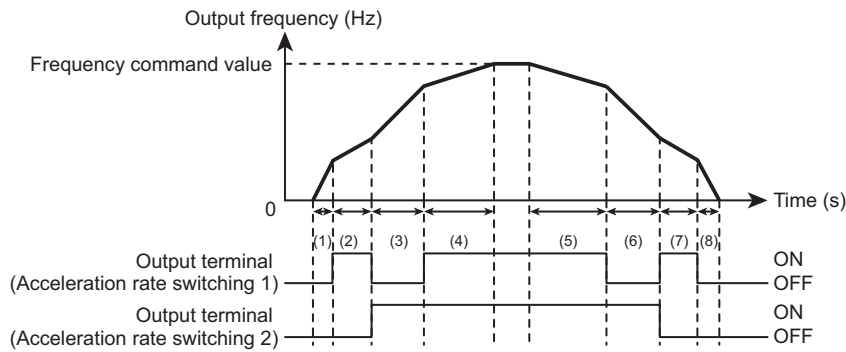

- (1) Accelerate by the inclination of the acceleration time <ACC>
- (2) Accelerate by the inclination of the acceleration time <F500>
- (3) Accelerate by the inclination of the acceleration time <F510>
- (4) Accelerate by the inclination of the acceleration time <F514>
- (5) Decelerate by the inclination of the deceleration time <F515>
- (6) Decelerate by the inclination of the deceleration time <F511>
- (7) Decelerate by the inclination of the deceleration time <F501>
- (8) Decelerate by the inclination of the deceleration time <dEC>

Set run command to terminal run. Set <CMOd: Run command select> to "0: Terminal".

Patterns 1 - 4 can be switched by turning the two input terminals ON/OFF.

Assign "32: Stall prevention switching/Torque limit switching 1" and "34: Torque limit switching 2" to the two unused input terminals.

	24: Acc/Dec switching 1	26: Acc/Dec switching 2
Acc/Dec 1	OFF	OFF
Acc/Dec 2	ON	OFF
Acc/Dec 3	OFF	ON
Acc/Dec 4	ON	ON

■ **Acc/Dec patterns**

You can individually select Acc/Dec patterns by selecting Acc/Dec 1, 2, 3 or 4.

Title	Parameter name	Adjustment range	Unit	Default setting
F502	Acc/Dec pattern 1	0: Linear 1: S-Pattern 1 2: S-Pattern 2		0
F503	Acc/Dec pattern 2			0
F512	Acc/Dec pattern 3			0
F516	Acc/Dec pattern 4			0
F506	S-Pattern range at Acc start	0-50	%	10
F507	S-Pattern range at Acc completion	0-50	%	10
F508	S-Pattern range at Dec completion	0-50	%	10
F509	S-Pattern range at Dec start	0-50	%	10

For details on the Acc/Dec patterns, refer to [6. 27. 1].

Parameters to determine S-Pattern ranges of "1: S-Pattern 1", <F506><F507><F508><F509>, is common to Acc/Dec patterns 1 - 4.

<b>Reference</b>	<ul style="list-style-type: none"> <li>• How to operate the operation panel -&gt; Refer to [3. 1. 1].</li> <li>• How to switch display mode on the operation panel -&gt; Refer to [3. 1. 2].</li> <li>• Procedure to change parameter setting -&gt; Refer to [4. 2. 3]</li> <li>• Details on operation by external signals -&gt; Refer to [Chapter 7].</li> </ul>
------------------	---

## 6. 28 Pattern operation

- <F520: Pattern operation>
- <F521: Pattern operation continue select>
- <F522: Pattern 1 repeat number>
- <F523: Pattern 1 select 1> to <F530: Pattern 1 select 8>
- <F531: Pattern 2 repeat number>
- <F532: Pattern 2 select 1> to <F539: Pattern 2 select 8>
- <F540: Operation time (1-speed)> to <F554: Operation time (15-speed)>

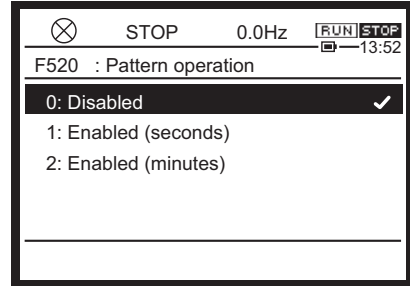

### ■ Function

You can perform terminal run according to up to 30 types (15 types x 2 patterns) of operation frequencies, operation time, and acceleration/deceleration time that were set in advance. Pattern operation switching, and Run/Stop are all input from the terminals.

### ■ Parameter setting

6

Title	Parameter name	Adjustment range	Unit	Default setting
F520	Pattern operation	0: Disabled 1: Enabled (seconds) 2: Enabled (minutes)		0
F521	Pattern operation continue select	0: Reset after stop 1: Continue after stop		0
F522	Pattern 1 repeat number	1-254 255: Continuous	Times	1
F523-F530	Pattern 1 select 1-8	0: Skip 1: Sr1 2: Sr2 3: Sr3 4: Sr4 5: Sr5 6: Sr6 7: Sr7 8: F287 9: F288 10: F289 11: F290 12: F291 13: F292 14: F293 15: F294		0
F531	Pattern 2 repeat number	1-254 255: Continuous	Times	1
F532-F539	Pattern 2 select 1-8	Same as <F523>		0
F540-F554	Operation time (1 to 15-speed)	0.1-5999 6000: Continuous	The unit is set at <F520>.	5.0

Title	Parameter name	Adjustment range	Unit	Default setting
F560	Preset speed operation style	0: Frequency only 1: With function	-	0
F561 - F575	Operation function (1-speed) to Operation function (15-speed)	0: Fwd run +1: Rev run +2: Acc/Dec switching signal 1 +4: Acc/Dec switching signal 2 +8: V/f switching signal 1 +16: V/f switching signal 2 +32: Torque limit switching signal 1 +64: Torque limit switching signal 2		0

When auto-restart after momentary stop is set, time is also added to the pattern operation time during catch on fly. Therefore, the actual operation time may be shorter than the setting time.

### ■ How to use the parameters

The basic operation method is as follows:

#### 1) Set <F520: Pattern operation> to "1: Enabled (seconds)" or "2: Enabled (minutes)".

This parameter is used to select the time unit (seconds/minutes) for <F540: Operation time (1-speed)> to <F554: Operation time (15-speed)>.

#### 2) Set the frequency to operate.

To set the frequencies to be used for pattern operations, do so at the following parameters related to preset-speed frequencies, not at specific parameters.

- <Sr1: Preset speed 1> to <Sr7: Preset speed 7>
- <F287: Preset speed 8> to <F294: Preset speed 15>

#### 3) To attach function to the frequency to operate, set <F560: Preset speed operation style> to "1: With function".

The function can be set to each frequency to operate. Set required functions, e.g. Fwd, Rev, Acc/Dec switching 1, 2, V/f switching 1, 2, to the following parameters.

- <F561: Operation function (1-speed)> through <F575: Operation function (15-speed)>

For details, refer to [5. 3. 7].

#### 4) Set the required operation time at <F540: Operation time (1-speed)> to <F554: Operation time (15-speed)> for every frequency to operate. Select the unit (seconds/minutes) at <F520: Acc/Dec switching frequency 1>.

#### 5) Set the order of frequency to operate.

Three parameter setting methods are provided.

- Select pattern operation mode at <F521: Pattern operation continue select>.

##### 0: Reset after stop

Operation is resumed after the pattern operations are reset by stop or switching operation.

##### 1: Continue after stop

Pattern operations are started by stop or switching operation. After completion of a routine, operation stops or the next routine is started.

- Select pattern groups to set the order of frequencies to operate.
  - <F522: Pattern 1 repeat number>
  - <F523: Pattern 1 select 1> to <F530: Pattern 1 select 8>
  - <F531: Pattern 2 repeat number>
  - <F532: Pattern 2 select 1> to <F539: Pattern 2 select 8>
- You can set parameter groups to operate by turning the input terminal ON/OFF. Assign "38: Pattern operation 1" and "40: Pattern operation 2" to the two unused input terminals. Also, assigning "42: Pattern operation continuation" and "44: Pattern operation start" to other input terminals allows you can select operation method by turning them ON/OFF.

**6) Display status of pattern operation in [Monitor mode].**

The status of the pattern operation can be checked in [Monitor mode]. Set the monitor numbers shown in the following table to <F711: Monitor mode 1 display> to <F718: Monitor mode 8 display>.

Monitor number	Operation status	Example of display	Example of content
66	Pattern operation group number	P1.0	Indicates Pattern group 1.
67	Pattern operation remaining cycle number	n123	Indicates that the 123rd pattern is being performed.
68	Pattern operation preset speed number	F1	Indicates that 1-speed frequency is used to operate.
69	Pattern operation remaining time	123.4	Indicates that the current pattern will be ended in 123.4 seconds.

6

■ **Pattern operation switching output**

Signals can be output when all pattern operations are ended.  
 Assign "36: Pattern operation switching" to an output terminal.  
 Output is turned OFF when run command is off and when the pattern operation selection is changed.

■ **Notes for pattern operation**

- You need to input pattern operation group selection from the terminal.
- When all input terminals with pattern operation assigned are turned OFF, and after pattern operation is ended, normal operation will start.
- When multiple group numbers are simultaneously input, operations will be performed in the order of the increasing group numbers, to automatically change to the next group. In this case, it may take approximately 0.06 second (per pattern) to search the patterns.
- Turn pattern operation 1 or 2 ON, wait for 10 ms or more to elapse, then turn ON the run command. Turning the run command ON early may cause operation with normal output frequency instead of pattern operation.
- <F964: Preset speed 16> to <F979: Preset speed 31> cannot be set to pattern operation.

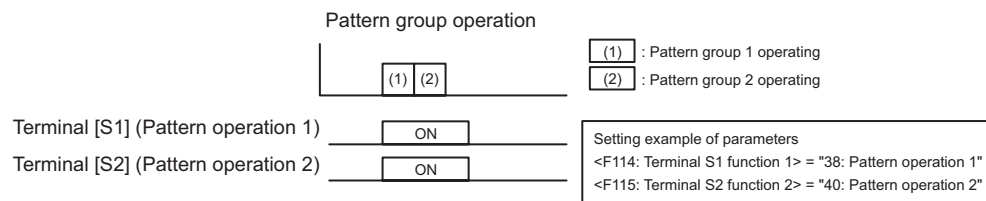

Reference

- How to operate the operation panel -> Refer to [3. 1. 1].
- How to switch display mode on the operation panel -> Refer to [3. 1. 2].
- Procedure to change parameter setting -> Refer to [4. 2. 3]
- Details on operation by external signals -> Refer to [Chapter 7].

## 6. 29 Shock monitoring function

<F590: Shock monitoring>

<F591: Shock monitoring trip>

<F592: Shock monitoring detection>

<F593: Shock monitoring detection level>

<F595: Shock monitoring detection time>

<F596: Shock monitoring detection hysteresis>

<F597: Shock monitoring detection wait time>

<F598: Shock monitoring detection condition>

For details, refer to Shock Monitoring Function Instruction Manual (E6582098).



## 6. 30 Setting the protection functions

Set the protection functions against electric thermal, current stall prevention operation, input/output phase failure, short circuit, ground fault, overtorque, undervoltage, analog signal disconnection, etc. for safety operation.

### 6. 30. 1 Setting the motor electronic thermal protection

<F606: Motor overload reduction frequency threshold>

<F607: Motor overload time>

<F631: Inverter overload detection>

<F632: Electronic thermal memory target>

<F657: Overload alarm level>

For details on the motor electronic thermal functions, refer to [5. 2. 5].

## 6. 30. 2 Setting overcurrent stall

 **CAUTION**



Prohibited

- Do not set the stall prevention level parameters (F601 and F185) extremely low. If the stall prevention level parameters (F601 and F185) are set at or below the motor no-load current, the stall preventive function will be always enabled and increase the frequency when it judges that regenerative braking is taking place. Do not set the stall prevention level parameters (F601 and F185) at 30% or less under normal use conditions.

<F601: Stall prevention level 1>

<F185: Stall prevention level 2>

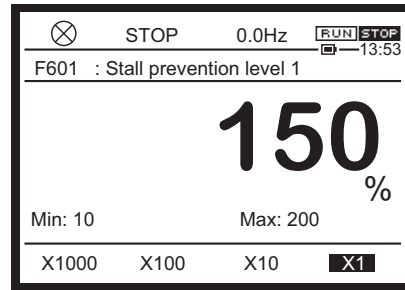

6

### ■ Function

If the current exceeding the level set at Stall prevention level 1 or 2 is flowed, stall prevention operation will be enabled to lower the output frequencies. Setting the output frequency low lowers output current of fans and pumps, which prevents overcurrent trip.

### ■ Parameter setting

Title	Parameter name	Adjustment range	Unit	Default setting
F601	Stall prevention level 1	10-200 (HD) 10-160 (ND)	%	*1
F185	Stall prevention level 2			

\*1 Depending on capacity. For details, refer to [11. 6].  
In case F601=199, 200(or 159, 160), stall prevention control is not activated.

### ■ How to set the parameter

100% reference is the inverter rated current. To switch <F601: Stall prevention level 1> between <F185: Stall prevention level 2>, use signals to input terminal. Assign "32: Stall prevention switching/Torque limit switching 1" to the unused input terminal. For details, refer to [7. 2. 1].

### ■ Display during the stall prevention operation

If the current exceeding the stall prevention level is about to flow, the output frequency will change. At this time, the letter "C" will blink.

Reference

- How to operate the operation panel -> Refer to [3. 1. 1].
- How to switch display mode on the operation panel -> Refer to [3. 1. 2].
- Procedure to change parameter setting -> Refer to [4. 2. 3]

### 6. 30. 3 Retaining trip types

<F602: Trip record retention>

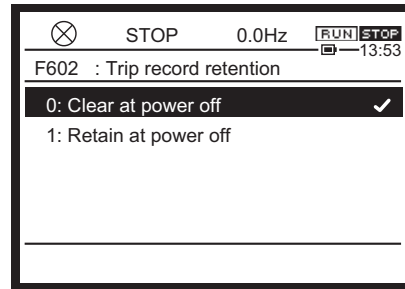

■ Function

Trip can be reset by turning power off, but you can set to retain details about trip occurrence even when power is turned off. After power off, the saved trip type will be displayed after turning power on again. If trip factor is remaining, however, the trip will occur again.

■ Parameter setting

Title	Parameter name	Adjustment range	Default setting
F602	Trip record retention	0: Clear at power off 1: Retain at power off	0

■ Selecting a setting value

**0: Clear at power off**

Reset the trip at power off. Trip type will not be retained after turning power on again.

**1: Retain at power off**

The following shows how the inverter operates after power off.

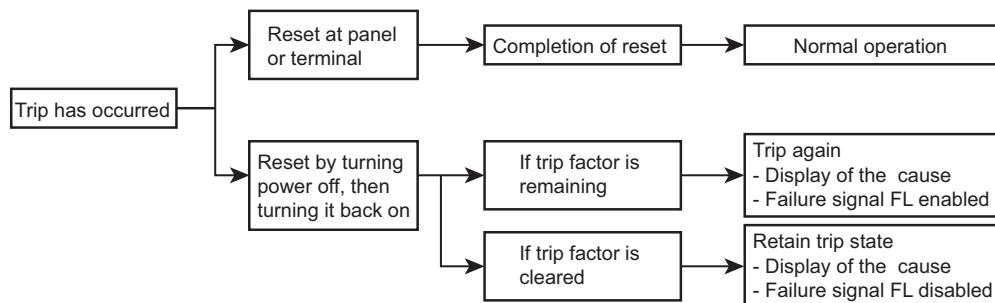

**Memo**

- The causes of the last eight trips can be displayed in [Monitor mode] even if the trip record retention is set. For details, refer to [8. 1. 1].
- If the power is turned on again, the data at trip in [Monitor mode] will not be retained. Check the data on the details monitor for the past trip history. For details, refer to [8. 1. 2].
- Even if the power is turned ON during retry, a trip record will be retained.

**Reference**

- How to operate the operation panel -> Refer to [3. 1. 1].
- How to switch display mode on the operation panel -> Refer to [3. 1. 2].
- Procedure to change parameter setting -> Refer to [4. 2. 3]

## 6. 30. 4 Emergency off

- <F603: Emergency off stop pattern>
- <F604: Emergency DC braking time>

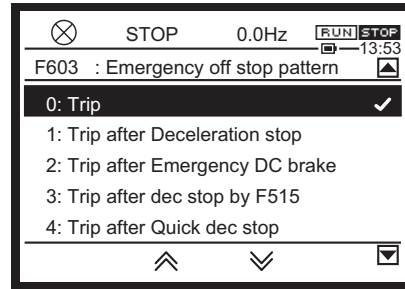

### ■ Function

Set the stop pattern for emergency off  
At the time of emergency off, a trip occurs. The trip display is "E".

### ■ Parameter setting

Title	Parameter name	Adjustment range	Unit	Default setting
F603	Emergency off stop pattern	0: Trip 1: Trip after Deceleration stop 2: Trip after Emergency DC braking 3: Trip after deceleration stop by F515 4: Trip after Quick deceleration stop 5: Trip after Dynamic quick deceleration stop		0
F604	Emergency DC braking time	0.0-20.0	s	1.0
F251	DC braking current	0 - 100	%	50
F515	Deceleration time 4	0.0-6000	s	*1

\*1 Depending on capacity. For details, refer to [11. 6].

### ■ Select the setting value for <F603: Emergency off stop pattern>

#### 0: Trip

A trip occurs by emergency off command. The motor performs coast stop.

#### 1: Trip after Deceleration stop

A trip occurs after deceleration stop is performed for the period of time set for <dEC: Deceleration time 1>.

#### 2: Trip after Emergency DC braking

The inverter stops after emergency DC braking, and a trip occurs.  
Set <F251: DC braking current> and <F604: Emergency DC braking time>.

#### 3: Trip after deceleration stop by <F515>

A trip occurs after deceleration stop is performed for the period of time set for <F515: Deceleration time 4>.  
Set <F515>.

Use this parameter when you want to set deceleration time for normal operation and emergency off in different time.

#### 4: Trip after Quick deceleration stop

After quick deceleration is performed, a trip occurs after stop.

In quick deceleration stop, the motor can decelerate more quickly than normal deceleration by increasing the voltage to the motor (over-excitation control) to increase the energy consumed by the motor when the voltage reaches the overvoltage limit operation level during deceleration.

#### 5: Trip after Dynamic quick deceleration stop

A trip occurs after Dynamic quick deceleration stop.

In Dynamic quick deceleration, the motor may be decelerated more quickly than quick deceleration control by increasing the voltage to the motor (over-excitation control) to increase the energy consumed by the motor as soon as the motor starts decelerating.

### ■ How to use

#### 1) Emergency off via external signal

Emergency off can be performed via a signal to a terminal. Assign "20: Emergency off" to the input terminal. Select how to stop the operation in <F603>.

Emergency off from the terminals is always given priority even during panel run.

#### 2) Emergency off from the operation panel

Emergency off can be performed on the operation panel when panel run is not performed.

To perform emergency off, press the [STOP] key on the operation panel twice.

For details on the operation, refer to [3. 2. 3].

The inverter cannot be reset the trip while the emergency off signal is being input to the input terminal. Reset a trip after releasing the signal.

#### Reference

- How to operate the operation panel -> Refer to [3. 1. 1].
- How to switch display mode on the operation panel -> Refer to [3. 1. 2].
- Procedure to change parameter setting -> Refer to [4. 2. 3]
- Details on operation by external signals -> Refer to [Chapter 7].

## 6. 30. 5 Output phase loss detection

<F605: Output phase loss detection>

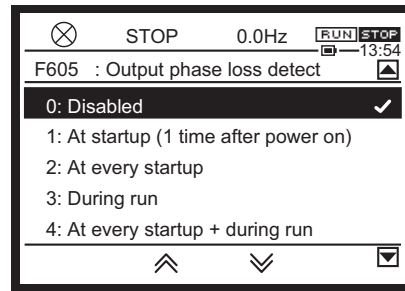

### ■ Function

When the phase loss on the inverter output side is detected, and after a certain period of time passed, a trip occurs. The trip display is "EPHO".

### ■ Parameter setting

Title	Parameter name	Adjustment range	Default setting
F605	Output phase loss detection	0: Disabled 1: At startup (only one time after power on) 2: At every startup 3: During run 4: At every startup + during run 5: Output shut off detection	0

6

### ■ How to select a setting value

#### 0: Disabled

A trip does not occur. (Failure signal FL disabled)

#### 1: At startup (only one time after power on)

After the power is turned on, output phase loss is detected at the first startup, and a trip occurs after a certain period of time passed. (Failure signal FL enabled)

#### 2: At every startup

At every startup, output phase loss is detected, and a trip occurs after a certain period of time passed. (Failure signal FL enabled)

#### 3: During run

A phase loss is detected during run, and a trip occurs after a certain period of time passed. (Failure signal FL enabled)

#### 4: At every startup + during run

At every startup and during run, a phase loss is detected, and a trip occurs after a certain period of time passed. (Failure signal FL enabled)

#### 5: Output shut off detection

In case you release between the motor and inverter for commercial power supply, restart the operation with low-voltage by controlling impact after the connection at the output side is off and connect it again. (Failure signal FL disabled)

Detection is not performed at auto-restart.

An output phase loss is detected at auto-tuning regardless of the setting for <F605: Output phase loss detection>.

**Memo**

- If <Pt: V/f Pattern> = "5" and "6" is set, 3-phase loss at <F605>="3", or "4", and <F605>="5" will be disabled.
- For special motors such as high-speed motors, detection error may occur.

**Reference**

- How to operate the operation panel -> Refer to [3. 1. 1].
- How to switch display mode on the operation panel -> Refer to [3. 1. 2].
- Procedure to change parameter setting -> Refer to [4. 2. 3]
- Details on operation by external signals -> Refer to [Chapter 7].



## 6. 30. 6 Input phase loss detection

<F608: Input phase loss trip>

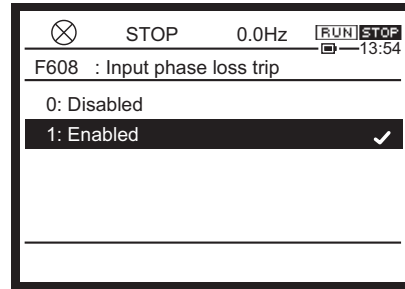

### ■ Function

If the phase loss on the inverter input side is detected and an abnormal ripple voltage persists in the power circuit capacitor for a certain period of time, a trip occurs. The trip display is "EPHI".

### ■ Parameter setting

Title	Parameter name	Adjustment range	Default setting
F608	Input phase loss trip	0: Disabled 1: Enabled	1

6

### ■ Difference between the settings

#### 0: Disabled

A trip does not occur. (Failure signal FL disabled)

#### 1: Enabled

If the phase loss is detected during run and an abnormal ripple voltage persists in the power circuit capacitor for a certain period of time, a trip occurs. (Failure signal FL enabled)



Important

- In case of light-load operation or if the motor capacity is too small for the inverter capacity, input phase loss may not be detected.
- If the power supply capacity is too large for the inverter capacity (500 kVA or more, and 10 times or more), detection error may occur. In this case, install an input reactor.
- When <F608> = "0: Disabled", if heavy-load operation continues in the phase loss status on the input side, the power circuit capacitor of inverter may be damaged.
- To operate the inverter with DC input, set <F608: Input phase loss trip> to "0: Disabled".
- To operate the inverter with DC input with size A4 to A6, set <F640: DC supply input> to "1". In this case input phase loss detection is disabled independent to F608 setting.

### Reference

- How to operate the operation panel -> Refer to [3. 1. 1].
- How to switch display mode on the operation panel -> Refer to [3. 1. 2].
- Procedure to change parameter setting -> Refer to [4. 2. 3]

## 6. 30. 7 Undercurrent detection

- <F610: Undercurrent trip>
- <F609: Undercurrent detection hysteresis>
- <F611: Undercurrent detection level>
- <F612: Undercurrent detection time>

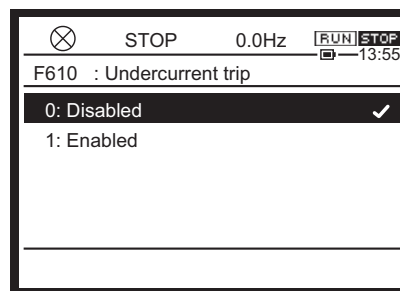

### ■ Function

Trips or outputs an alarm when the output current falls to the value set in <F611: Undercurrent detection level> or less for the time specified in <F612: Undercurrent detection time>.

Hysteresis can be set by <F609: Undercurrent detection hysteresis> The trip display is "UC".

### ■ Parameter setting

Title	Parameter name	Adjustment range	Unit	Default setting
F610	Undercurrent trip	0: Disabled 1: Enabled		0
F609	Undercurrent detection hysteresis	1 - 20	%	10
F611	Undercurrent detection level	0 - 150	%	0
F612	Undercurrent detection time	0 - 255	s	0

### ■ Difference depending on the setting of <F610: Undercurrent trip>

#### 0: Disabled

A trip does not occur. (Failure signal FL disabled)

Undercurrent (UC) alarm can be output from the output terminal.

Assign "26: Undercurrent (UC) alarm" to an unused output terminal.

#### 1: Enabled

When a current level set in <F611: Undercurrent detection level> or less is detected for the period of time set in <F612: Undercurrent detection time> or more, the inverter trips and "UC" is displayed. (Failure signal FL enabled)

### ■ Setting example

Set "26: Undercurrent (UC) alarm" to the unused output terminal.

In the case of <F610: Undercurrent trip> = "0: Disabled", the signal can be output from the output terminal as follows.

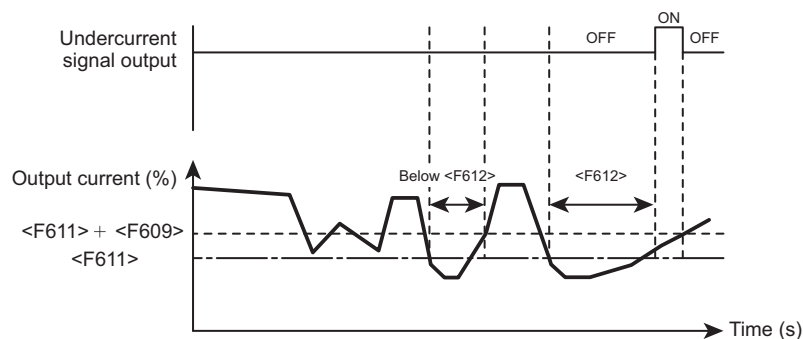

In the case of <F610: Undercurrent trip> = "1: Enabled", when a current is <F611: Undercurrent detection level> or less for the period of time specified by <F612: Undercurrent detection time>, the inverter trips.

After tripping, undercurrent (UC) alarm signal remains ON.

Reference

- How to operate the operation panel -> Refer to [3. 1. 1].
- How to switch display mode on the operation panel -> Refer to [3. 1. 2].
- Procedure to change parameter setting -> Refer to [4. 2. 3]
- Details on operation by external signals -> Refer to [Chapter 7].

## 6. 30. 8 Overtorque detection

- <F615: Overtorque trip>
- <F616: Overtorque detection level during power running>
- <F617: Overtorque detection level during regen>
- <F618: Overtorque detection time>
- <F619: Overtorque detection hysteresis>

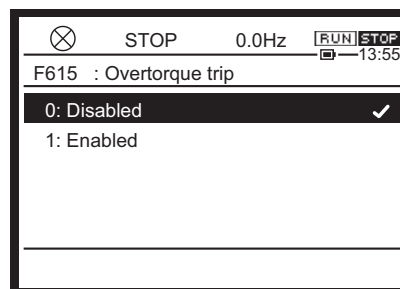

### ■ Function

The power running torque value is <F616: Overtorque detection level during power running> or more, or the regen torque value is <F617: Overtorque detection level during regen> or more, and remains over for the time specified by <F618: Overtorque detection time>, tripping or alarm can be output. You can enable or disable the trip setting by <F615: Overtorque trip>. The trip display is "Ot".

### ■ Parameter setting

Title	Parameter name	Adjustment range	Unit	Default setting
F615	Overtorque trip	0: Disabled 1: Enabled		0
F616	Overtorque detection level during power running	0: Disabled *1 1 - 320	%	150
F617	Overtorque detection level during regen	0: Disabled *1 1 - 320	%	150
F618	Overtorque detection time	0.0-10.0 *2	s	0.5
F619	Overtorque detection hysteresis	0 - 100	%	10

\*1 You can output an alarm set regardless of the <F615> setting. Trip or alarm cannot be output when <F616> or <F617> is set to "0: Disabled".

\*2 <F618>="0.0" seconds is the shortest time detected on control.

### ■ Difference depending on the setting of <F615: Overtorque trip>

#### 0: Disabled

A trip does not occur. (Failure signal FL disabled)

Overtorque (OT) alarm can be output when the power running torque value is <F616> or more, or the regen torque value is <F617> or more, is detected for the period of time specified by <F618>.

**1: Enabled**

The inverter trips when the power running torque value is <F616> or more, or the regen torque value is <F617> or more, is detected over the period of time specified by <F618> or longer. Overtorque (OT) alarm can also be output from the output terminal. (Failure signal FL enabled)

■ **Setting example**

Assign "28: Overtorque (OT) alarm" to the unused output terminal.

In the case of <F615: Overtorque trip> = "0: Disabled", the alarm functions as follows.

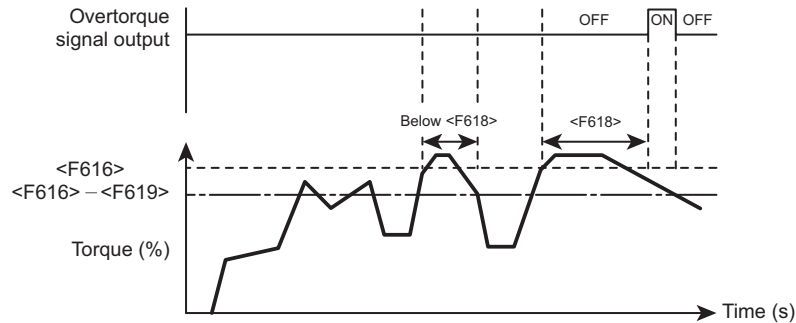

When <F615: Overtorque trip> = "1: Enabled", the inverter trips if overtorque is detected for the period of time specified by <F618: Overtorque detection time>.

After that, overtorque (OT) alarm remains ON.

Reference

- How to operate the operation panel -> Refer to [3. 1. 1].
- How to switch display mode on the operation panel -> Refer to [3. 1. 2].
- Procedure to change parameter setting -> Refer to [4. 2. 3]
- Details on operation by external signals -> Refer to [Chapter 7].

## 6. 30. 9 Short circuit detection at start

<F613: Short circuit detection at start>

<F614: Pulse width of short circuit detection at start>

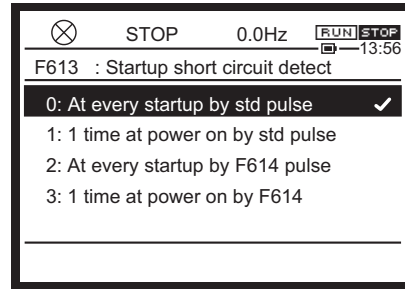

### ■ Function

Inverter detects inverter output short-circuit at the start.

Normally, short-circuit can be detected in the length of standard pulse (50 μs). When operating a low-impedance motor, such as a high-speed motor, however, select the short-time pulse by <F614:Pulse width of short circuit detection at start> to prevent an error detection.

### ■ Parameter setting

6

Title	Parameter name	Adjustment range	Unit	Default setting
F613	Short circuit detection at start	0: At every startup by standard pulse 1: Only one time after power on by standard pulse 2: At every startup by F614 setting pulse 3: Only one time after power on by F614 setting pulse		0
F614	Pulse width of short circuit detection at start	0: No short circuit detection at start in case F613="2", or "3" 1 - 50	μs	25

### ■ Setting the <F613: Short circuit detection at start>

#### 0: At every startup by standard pulse

Detection is executed in the length of standard pulse every time at the start of inverter operation.

#### 1: Only one time after power on by standard pulse

Detection is executed in the length of standard pulse only during the first start-up at power on or after resetting.

#### 2: At every startup by F614 setting pulse

Detection is executed in the length of short-time pulse specified by <F614: Pulse width of short circuit detection at start> every time at the start of inverter operation.

#### 3: Only one time after power on by F614 setting pulse

Detection is executed in the length of short-time pulse specified by <F614: Pulse width of short circuit detection at start> only one time during the first start-up at power on or after resetting.

Reference

- How to operate the operation panel -> Refer to [3. 1. 1].
- How to switch display mode on the operation panel -> Refer to [3. 1. 2].
- Procedure to change parameter setting -> Refer to [4. 2. 3]
- Details on operation by external signals -> Refer to [Chapter 7].

## 6. 30. 10 Ground fault detection

### <F636: Ground fault trip>

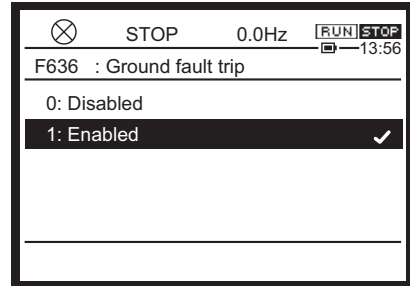

#### ■ Function

Inverter detects the ground fault.

If a ground fault occurs in the inverter unit or output side, the inverter will trip. The trip display is "EF2".

6

#### ■ Parameter setting

Title	Parameter name	Adjustment range	Default setting
F636	Ground fault trip	0: Disabled 1: Enabled	1

#### ■ How to select a setting value

##### 0: Disabled

A trip does not occur. (Failure signal FL disabled)

In this case, installation of a ground detector, such as a ground relay, is recommended.

##### 1: Enabled

Ground fault detection is enabled.

The inverter will trip when ground fault is detected. (Failure signal FL enabled)

Reference

- How to operate the operation panel -> Refer to [3. 1. 1].
- How to switch display mode on the operation panel -> Refer to [3. 1. 2].
- Procedure to change parameter setting -> Refer to [4. 2. 3]
- Details on operation by external signals -> Refer to [Chapter 7].

## 6. 30. 11 Cooling fan control

<F620: Cooling fan control>

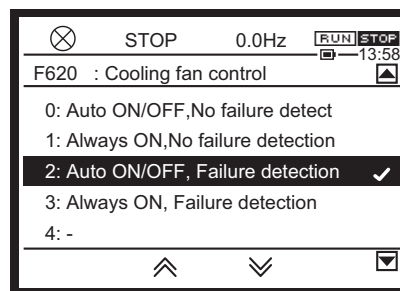

### ■ Function

The cooling fan run only when the ambient temperature is high and during run. This way, the service life of cooling fan can be extended compared to when keep running the cooling fan while the power is ON. It is also able to trip when the capability of the cooling fan falls below a certain level. The trip display is "E-42".

### ■ Parameter setting

Title	Parameter name	Adjustment range	Default setting
F620	Cooling fan control	0: Auto ON/OFF, No failure detection 1: Always ON, No failure detection 2: Auto ON/OFF, Failure detection 3: Always ON, Failure detection 4 - 7: -	2

\*When the motor speed of the cooling fan is lower than a certain level, cooling fan fault alarm can be output from the output terminal regardless of the setting in <F620>.

### ■ Selecting a setting value

#### 0: Auto ON/OFF, No failure detection

Cooling fan is automatically controlled. Cooling fan operates only when the ambient temperature is high and during run.

Cooling fan operates automatically, if the ambient temperature is high, even when the inverter is in a stop.

#### 1: Always ON, No failure detection

Cooling fan runs all the time when the inverter is on.

Trip does not occur at the time of the cooling fan failure. (Failure signal FL disabled)

#### 2: Auto ON/OFF, Failure detection

Cooling fan is automatically controlled. Cooling fan runs only when the ambient temperature is high and during operation.

When the motor speed of the cooling fan is lower than a certain level, a trip occurs. (Failure signal FL enabled)

#### 3: Always ON, Failure detection

Cooling fan runs all the time when the inverter is on.



When the motor speed of the cooling fan is lower than a certain level, a trip occurs. (Failure signal FL enabled)

#### ■ Output during cooling fan run

If you assign the function to the unused output terminal, cooling fan fault alarm can be output while the cooling fan is running.

"50: During cooling fan run"

"190: Cooling fan fault alarm"

If you set <F620: Cooling fan control> to "2" or "3", a trip occurs at the time of the cooling fan fault. The trip display is "E-42".

#### Reference

- How to operate the operation panel -> Refer to [3. 1. 1].
- How to switch display mode on the operation panel -> Refer to [3. 1. 2].
- Procedure to change parameter setting -> Refer to [4. 2. 3]
- Details on operation by external signals -> Refer to [Chapter 7].

## 6. 30. 12 Cumulative run time alarm setting

<F621: Cumulative run time alarm>

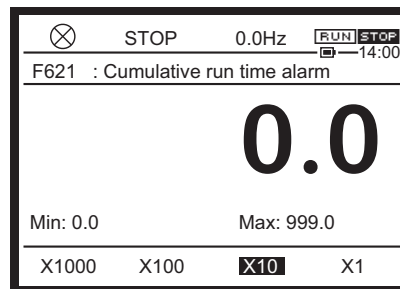

### ■ Function

This parameter activates the alarm from the output terminal after the inverter's cumulative run time is <F621: Cumulative run time alarm> or more.

### ■ Parameter setting

Title	Parameter name	Adjustment range	Unit	Default setting
F621	Cumulative run time alarm	0.0 - 999.0	100 h	876.0

### ■ Signal output of cumulative run time alarm

Assign "56: Cumulative run time alarm" to the unused output terminal.

#### Memo

- Cumulative run time up to the present time can be confirmed in the [Monitor mode].
- Monitor value of the cumulative run time can be reset to 0 (zero) by selecting "5: Clear cumulative run time" in the default setting <tyP: Default setting>. For details, refer to [5. 2. 9].

#### Reference

- How to operate the operation panel -> Refer to [3. 1. 1].
- How to switch display mode on the operation panel -> Refer to [3. 1. 2].
- Procedure to change parameter setting -> Refer to [4. 2. 3]
- Details on operation by external signals -> Refer to [Chapter 7].

## 6. 30. 13 Speed error (over speed) detection

<F622: Abnormal speed detection time>

<F623: Abnormal speed increase band>

<F624: Abnormal speed decrease band>

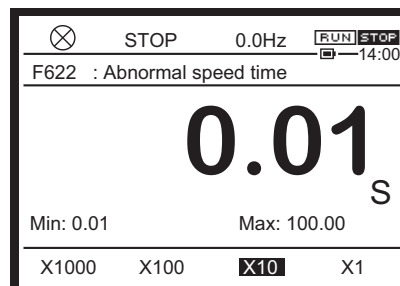

■ **Function**

When operating without the PG feedback (<Pt: V/f Pattern> = "0" - "9"), if the rough speed exceeds the speed limit over the setting time, this parameter announces an error and outputs a failure.

When operating with the PG feedback (<Pt: V/f Pattern> = "10" or "11"), the parameter monitors the speed feedback value and a trip occurs when speed exceeds the speed limit over the setting time.

When output frequency > (<FH> +12 Hz) or > (<FH> + <vL>/10) at all <Pt>, a trip occurs. The trip display is "E-13".

■ **Parameter setting**

Title	Parameter name	Adjustment range	Unit	Default setting
F622	Abnormal speed detection time	0.01 - 100.0	s	0.01
F623	Abnormal speed increase band	0.00: Disabled 0.01 - 30.0	Hz	0.00
F624	Abnormal speed decrease band	0.00: Disabled 0.01 - 30.0	Hz	0.00

■ **Guideline for the setting**

If speed feedback (Estimated speed) > (Output frequency + <F623>) or speed feedback (Estimated speed) < (Output frequency - <F624>), and a certain period of time set with <F622: Abnormal speed detection time>, a trip occurs.

You can provide range for a detection level of a trip with a setting of <F623: Abnormal speed increase band> and <F624: Abnormal speed decrease band>

During torque control, if speed feedback (Estimated speed) > (Speed upper limit + <F623>) or > (Speed lower limit - <F624>) a certain period of time set with <F622: Abnormal speed detection time>, "E-13" trip occurs.

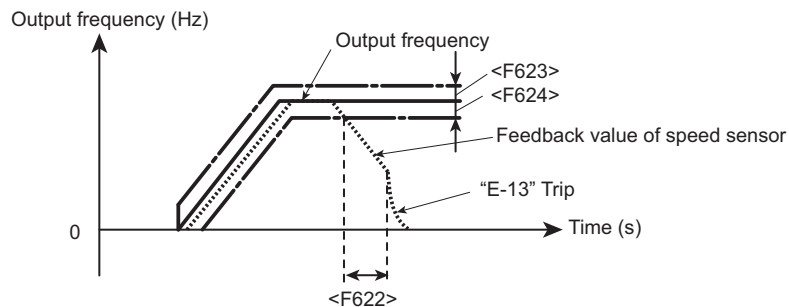

**Memo**

- When the setting value is 0 (zero), this function may not become activated properly while in the stall protection mode. To maintain this function, use of setting <F451: Acc/Dec operation after stall operation> = "1: Minimum time" is recommended. For details, refer to [6. 24. 2].

**Reference**

- How to operate the operation panel -> Refer to [3. 1. 1].
- How to switch display mode on the operation panel -> Refer to [3. 1. 2].
- Procedure to change parameter setting -> Refer to [4. 2. 3]
- Details on operation by external signals -> Refer to [Chapter 7].

## 6. 30. 14 Undervoltage trip setting

- <F627: Undervoltage trip>
- <F625: Undervoltage detection level>
- <F628: Undervoltage detection time>

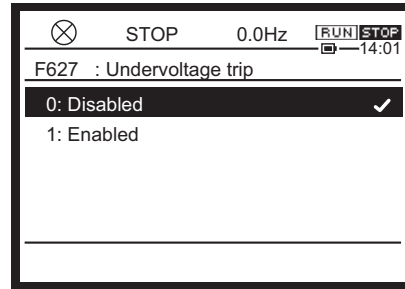

### ■ Function

This parameter sets the action when undervoltage of the power circuit is detected. When undervoltage is detected, it displays "MOFF" and stops. Alarm can be output from the output terminal. If you want to trip, set by <F627: Undervoltage trip>. The trip display is "UP1".

### ■ Parameter setting

Title	Parameter name	Adjustment range	Unit	Default setting
F627	Undervoltage trip	0: Disabled 1: Enabled		0
F625	Undervoltage detection level	50 - 79 80: Auto	%	80 *1
F628	Undervoltage detection time	0.01 - 10.00	s	0.03
F629	Regenerative power ride-through level	55 - 100	%	75

\*1 100% reference of <F625> is 200 V (240V class), 400 V (480V class).

### ■ Detection level of undervoltage alarm "MOFF"

Exclude <F625: Undervoltage detection level> = "80: Auto"  
The occurrence level of MOFF alarm is the setting value of <F625>. MOFF alarm will be cleared at the setting value of <F629: Regenerative power ride-through level>.

When <F625: Undervoltage detection level> = "80: Auto"  
Both occurrence level and clear level of MOFF alarm is followed by the level specified by the internal setting.

### ■ Setting the <F627: Undervoltage trip>

#### 0: Disabled

The inverter stops but does not trip. (Failure signal FL disabled)

#### 1: Enabled

The inverter trips after undervoltage is detected for the period of time set by <F628: Undervoltage detection time> or longer. The trip display is "UP1". (Failure FL enabled)

**Memo**

- While the inverter is stopped, undervoltage is not detected.

**Reference**

- How to operate the operation panel -> Refer to [3. 1. 1].
- How to switch display mode on the operation panel -> Refer to [3. 1. 2].
- Procedure to change parameter setting -> Refer to [4. 2. 3]

**6**

## 6. 30. 15 Brake answer waiting time setting

<F630: Brake answer wait time>

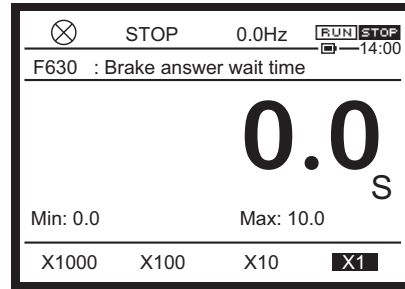

### ■ Function

This parameter can set the waiting time for the brake answer (reply) from the system. Input brake answer to the input terminal with "130: Brake answerback" is assigned.

After the operation start, when there is no answer after elapse of the setting time, the inverter trips. The trip display is "E-11".

### ■ Parameter setting

Title	Parameter name	Adjustment range	Unit	Default setting
F630	Brake answer wait time	0.0: Disabled 0.1 - 10.0	s	0.0

6

### Reference

- How to operate the operation panel -> Refer to [3. 1. 1].
- How to switch display mode on the operation panel -> Refer to [3. 1. 2].
- Procedure to change parameter setting -> Refer to [4. 2. 3]
- This function is used with "brake function".  
About "brake function", refer to "E6582104".

## 6. 30. 16 Analog input disconnection detection

- <F633: II analog input disconnection detection level>
- <F644: Operation after II analog input disconnection detection>
- <F649: Fallback frequency>

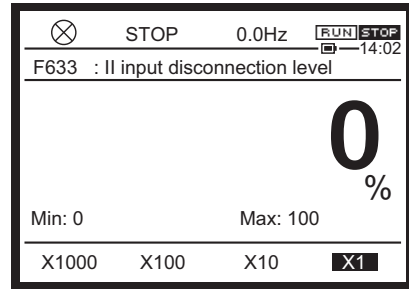

### ■ Function

This parameter sets the action when the analog input level for [II] terminal is the setting value of <F633: II analog input disconnection detection level> or less for approximately 0.3 seconds. You can trip the inverter or maintain its operation. The trip display is "E-18". If you select other than a trip, alarm "A-18" blinks.

### ■ Parameter setting

Title	Parameter name	Adjustment range	Unit	Default setting
F633	II analog input disconnection detection level	0: Disabled 1 - 100	%	0
F644	Operation after II analog input disconnection detection	1 : Frequency reference keeps just before reference, & Alarm. 2 : Ramp Coast stop, & Alarm 3 : Free wheel, & Alarm 4 : Free wheel, & Fault 5 : Frequency reference becomes F649, & Alarm.	-	4
F649	Fallback frequency	LL-UL	Hz	0.0

### ■ Setting the <F633: II analog input disconnection detection level>

**0: Disabled**  
No detection.

#### 1 - 100

Action of the inverter is based on the setting of <F644: Operation after II analog input disconnection detection> when the analog input level for [II] terminal is the setting value of <F633> or less for approximately 0.3 seconds.

### ■ Setting the <F644: Operation after II analog input disconnection detection>

This parameter sets the action when the analog input level for [II] terminal is the setting value of <F633> or less for approximately 0.3 seconds.

**1 : Frequency reference keeps just before reference**  
Continue running.



Alarm "A-18" blinks.

**2 : Ramp Coast stop,**

Deceleration stop.

Alarm "A-18" blinks.

**3 : Free wheel**

Coast stop.

Alarm "A-18" blinks.

**4 : Free wheel, & Fault**

Trip. The trip display is "E-18".

**5 : Frequency reference becomes F649**

The inverter runs with the frequency setting by <F649: Fallback frequency>.

Alarm "A-18" blinks.

**Memo**

- Depending on the degree of deviation of the analog data detected, disconnection may be detected too early.

6

**Reference**

- How to operate the operation panel -> Refer to [3. 1. 1].
- How to switch display mode on the operation panel -> Refer to [3. 1. 2].
- Procedure to change parameter setting -> Refer to [4. 2. 3].
- Details on operation by external signals -> Refer to [Chapter 7].

## 6. 30. 17 Setting parts replacement alarm by the ambient temperature

<F634: Annual average ambient temperature>

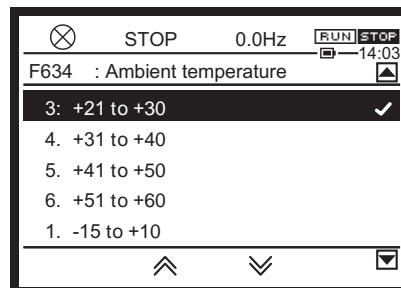

### ■ Function

Based on the inverter ON time (cumulative power ON time), motor run time (cumulative run time), cooling fan run time (cumulative cooling fan run time), output current, and <F634: Annual average ambient temperature>, the time of replacement of the cooling fan, power circuit capacitor, and capacitor mounted on a printed circuit board is calculated. When the time of replacement approaches, the alarm can be output on the monitor display and output terminal.

6

### ■ Parameter setting

Title	Parameter name	Adjustment range	Default setting
F634	Annual average ambient temperature	1: -15 to +10°C 2: +11 to +20°C 3: +21 to +30°C 4: +31 to +40°C 5: +41 to +50°C 6: +51 to +60°C	3

### ■ Selecting a setting value

Set the annual average temperature around the inverter. (This is not the annual highest temperature.)



Important

- Set <F634: Annual average ambient temperature> when installing the inverter. After the installation, this setting should not be changed. Otherwise, calculation of parts replacement alarm may have an error.

### ■ Signal output of parts replacement alarm

Assign the parts replacement alarm to the unused output terminal. For details, refer to [7. 2. 2].

"128: Parts replacement alarm"

"160: Cooling fan replacement alarm"

### ■ Monitor display of parts replacement alarm

Parts replacement alarm information (refer to [8. 1. 1]) can be checked in the [Monitor mode].

**Memo**

- Cumulative power ON time, cumulative fan run time, and cumulative run time can be checked in the [Monitor mode]. For details, refer to [8. 1. 1].
- Monitor value of cumulative fan run time and cumulative run time can be reset to 0 (zero) by the setting of <tyP: Default setting>. For details, refer to [5. 2. 9].

**Reference**

- How to operate the operation panel -> Refer to [3. 1. 1].
- How to switch display mode on the operation panel -> Refer to [3. 1. 2].
- Procedure to change parameter setting -> Refer to [4. 2. 3]
- Details on operation by external signals -> Refer to [Chapter 7].

## 6. 30. 18 Rush current suspension relay control

<F635: Rush current suppression relay delay time>

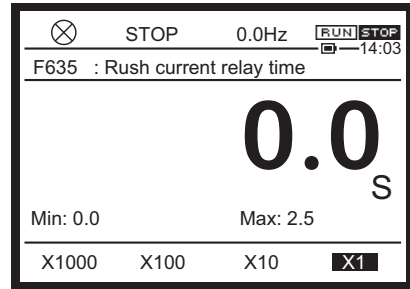

### ■ Function

This function is used for DC input or when multiple inverters are connected with DC section and when the rush current suspension resistor relay needs to be controlled.

### ■ Parameter setting

Title	Parameter name	Adjustment range	Unit	Default setting
F635	Rush current suppression relay delay time	0.0 - 2.5	s	0.0

### ■ Guideline for the setting

When the voltage of DC section in the inverter has reached the specified voltage, after a lapse of setting time by <F635: Rush current suppression relay delay time> +500ms (basic wait time), the rush current suspension relay is turned on.

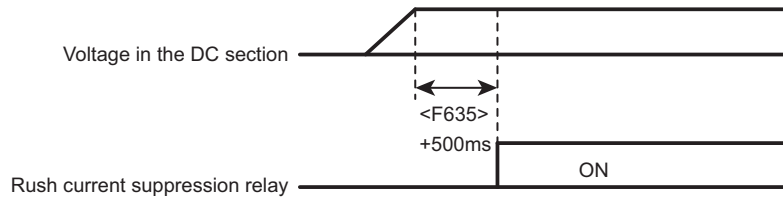

### Reference

- How to operate the operation panel -> Refer to [3. 1. 1].
- How to switch display mode on the operation panel -> Refer to [3. 1. 2].
- Procedure to change parameter setting -> Refer to [4. 2. 3]

## 6. 30. 19 Motor PTC thermal protection setting

- <F645: Terminal RRPTC trip>
- <F646: PTC detection resistance>
- <F108: Terminal RR input select>
- <F148: Terminal AI4 input select>
- <F149: Terminal AI5 input select>
- <F637: Terminal AI4 PTC trip>
- <F638: Terminal AI5 PTC trip>

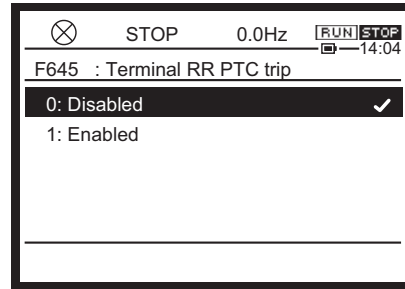

### ■ Function

This function is set to protect the motor from overheating by using PTC, which is integrated in the monitor.

You can trip the motor. The trip display is "E-32".

### ■ Parameter setting

Title	Parameter name	Adjustment range	Unit	Default setting
F645	Terminal RR PTC trip	0: Disabled 1: Enabled		0
F646	PTC detection resistance	100 - 9999	Ω	3000
F656	PTC detection temperature	0 - 200	°C	90
F108	Terminal RR input	1: Voltage input (0-10V) 2, 3: - 4: PTC input 5: PT100 (2-wire) input 6: - 7: PT100 (2-wire) input 8: - 9: KTY84 input		1
F148	Terminal AI4 input select	1: Voltage input (0-10 V) 2: Voltage input (-10 to +10 V) 3: Current input (0-20 mA) 4: PTC input 5: PT100 (2-wire) input 6: PT100 (3-wire) input 7: PT100 (2-wire) input 8: PT1000 (3-wire) input 9: KTY84 input		0
F149	Terminal AI5 input select			
F637	Terminal AI4 PTC trip	0: Disabled		0
F638	Terminal AI5 PTC trip	1: Enabled		

### ■ PTC thermal protection using terminal [RR]

Connect PTC between terminals [RR]-[CC].

Set "4", "5", "7", and "9" with <F108: Terminal RR switching>.

In <F645: Terminal RR PTC trip>, when "0: Disabled" is selected, pre-alarm only, and when "1: Enabled" is selected, pre-alarm and trip are enabled.

The trip level is the value which is set by <F646> when <F108>= "4: PTC input", and if <F108>= "5: PT100", "7: PT1000", and "9: KTY84", it is the setting value of <F656>.

Pre-alarm level is 60% of <F646> when <F108>="4".

Pre-alarm level is <F656> - 10 deg.C when <F108>="5", "7", and "9".

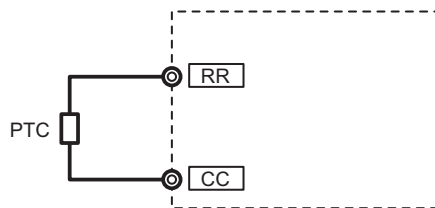

■ **Signal output of PTC input pre-alarm**

Assign "150: PTC input pre-alarm" to the unused output terminal.

**Memo**

- With optional terminals [AI4] and [AI5], PTC thermal protection is possible in the same manner. For details, refer to "I/O extension 1 installation manual" (E6582128).

6

**Reference**

- How to operate the operation panel -> Refer to [3. 1. 1].
- How to switch display mode on the operation panel -> Refer to [3. 1. 2].
- Procedure to change parameter setting -> Refer to [4. 2. 3]
- Details on operation by external signals -> Refer to [Chapter 7].

## 6. 30. 20 Protecting the control power supply option unit at a time of failure

<F647: Control power option failure detection>

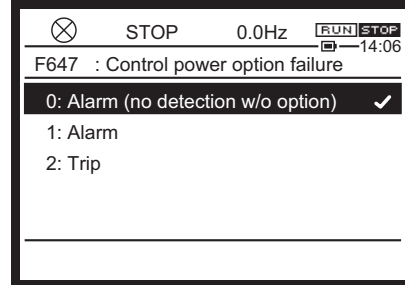

### ■ Function

When the control power supply option unit (CPS002Z) is used, if the unit does not output the voltage for 15 minutes or more due to some error, this function can activate alarm display or tripping.

### ■ Parameter setting

Title	Parameter name	Adjustment range	Default setting
F647	Control power option failure detection	0: Alarm (no detection without option) 1: Alarm 2: Trip	0

6

### ■ How to select a setting value

#### 0: Alarm (no detection without option)

This is selected when the control power supply backup is not necessary.

When no control power supply is input between terminals [+SU] externally, use this setting.

Also when the control power supply backup is selected, when failure occurs during run, the inverter output is shut off and the alarm "COFF" is displayed. When failure exists already at the time of voltage input, errors are not detected.

#### 1: Alarm

This is selected for the control power supply backup (alarm output).

When voltage of the control power supply which is input to terminal [+SU] drops, the inverter output is shut off, and the alarm "COFF" is displayed.

Once "COFF" has occurred, the alarm is not reset even when the control power supply voltage is recovered to the normal level. The alarm can be reset by turning off the power circuit.

#### 2: Trip

This is set for the control power supply backup (trip output).

This option enables the inverter trip when voltage of the control power drops. The trip display is "E-29". Different from the normal trip, the trip is maintained regardless of the setting status of <F602: Trip record retention>.

This setting is valid when the standard connection in [2. 3. 2] is used.

When an inverter failure occurs while the control power supply has an failure as follows, the main power supply may turn ON/OFF repeatedly. In such a case, select "1: Retain at power off" in <F602: Trip record retention>.

For details, refer to [6. 30. 3].

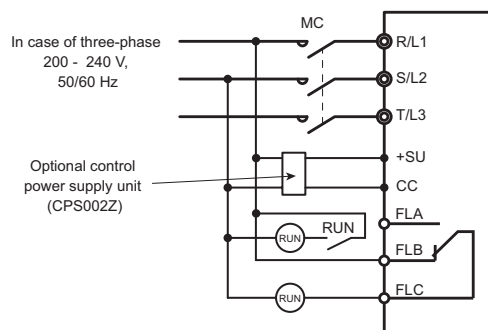

**Reference**

- How to operate the operation panel -> Refer to [3. 1. 1].
- How to switch display mode on the operation panel -> Refer to [3. 1. 2].
- Procedure to change parameter setting -> Refer to [4. 2. 3]



## 6. 30. 21 Setting number of starting alarm and alarm occurrence of the specified trip

- <F648: Number of starting alarm>
- <F658: Number of external equipment starting alarm>
- <F664: Specified trip 1>
- <F665: Specified trip 2>
- <F666: Specified trip 3>

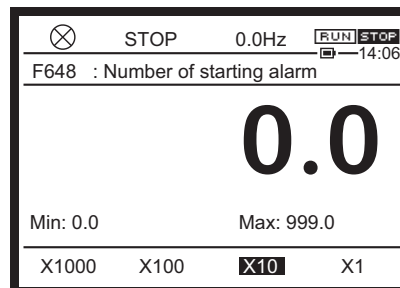

### ■ Function

This parameter counts the number of starting of the inverter, and when it reaches the value set by <F648: Number of starting alarm>, it outputs the alarm and confirm it in [Monitor mode].  
 For number of external equipment starting alarm, you can outputs the alarm and confirm it in [Monitor mode]. For number of starting for external equipment, the number of input to the input terminal is counted.  
 Also, occurrence of the specified trip can be confirmed in [Monitor mode].

### ■ Parameter setting

Title	Parameter name	Adjustment range	Unit	Default setting
F648	Number of starting alarm	0 - 999.0	x10,000 times	999.0
F658	Number of external equipment starting alarm	0 - 999.0	x10,000 times	999.0
F664	Specified trip 1	0 - 1 00	Times	0
F665	Specified trip2	0 - 1 00	Times	0
F666	Specified trip3	0 - 1 00	Times	0

### ■ Signal output of the number of starting alarm of the inverter

This parameter counts the number of starting of the inverter, and when it reaches the value set by <F648: Number of starting alarm>, it outputs the alarm and confirm it in [Monitor mode].

Output alarm

Assign "162: Number of starting alarm" to the unused output terminal. For details, refer to [7. 2. 2]. [Monitor mode]

Set "100: Number of starting" to <F711: Monitor mode 1 display> through <F718: Monitor mode 8 display>. For details, refer to [8. 1. 1].

### ■ Signal output of the number of external equipment starting alarm

This parameter counts the number of starting of the external equipment, and when it reaches the values set by <F658: Number of external equipment starting alarm>, it outputs the alarm and can be confirmed in [Monitor mode].

For Number of starting for external equipment, a signal to the input terminal with the function of "114: External equipment counter" is assigned is counted.

Output alarm

Assign "184: Number of external equipment starting alarm" to the unused output terminal. For details, refer to [7. 2. 2].

[Monitor mode]

Set "103: External equipment counter" to <F711: Monitor mode 1 display> through <F718: Monitor mode 8 display>. For details, refer to [8. 1. 1].

■ **Signal output of the number of occurrence of the specified trip**

You can confirm occurrence of the specified trip in [Monitor mode]. You can set up to three specified trips.

Set the monitor numbers shown in the following table to <F711: Monitor mode 1 display> to <F718: Monitor mode 8 display>. For details, refer to [8. 1. 1].

"113: Number of specified trip 1"

"114: Number of specified trip 2"

"115: Number of specified trip 3"

6

<b>Memo</b>	<ul style="list-style-type: none"> <li>• The number of starting, the number of forward run, and the number of reverse starting up to the present time can be confirmed in [Monitor mode]. You can reset the monitor value to 0 with the setting of "12: Clear number of starting" in &lt;tyP: Default setting&gt;. For details, refer to [5. 2. 9].</li> <li>• You can reset the monitor value of "external equipment counter" to 0 with the setting of "14: Clear number of external equipment starting" in &lt;tyP: Default setting&gt;. For details, refer to [5. 2. 9].</li> </ul>
<b>Reference</b>	<ul style="list-style-type: none"> <li>• How to operate the operation panel -&gt; Refer to [3. 1. 1].</li> <li>• How to switch display mode on the operation panel -&gt; Refer to [3. 1. 2].</li> <li>• Procedure to change parameter setting -&gt; Refer to [4. 2. 3]</li> <li>• Details on operation by external signals -&gt; Refer to [Chapter 7].</li> </ul>

## 6. 30. 22 Setting cumulative overcurrent level and time

<F659: Cumulative overcurrent level>

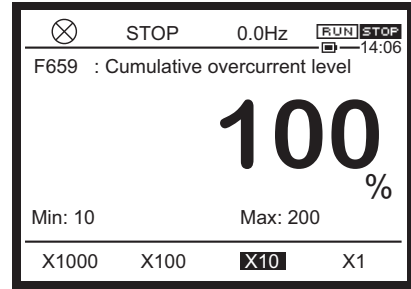

### ■ Function

Inverter cumulates the time when motor current is over this parameter. This cumulative time can be confirmed in [Monitor mode].

### ■ Parameter setting

Title	Parameter name	Adjustment range	Unit	Default setting
F659	Cumulative overcurrent level	10 - 200	%	100

6

### ■ Signal output of the cumulative overcurrent time

You can confirm the cumulative overcurrent time in [Monitor mode].

Set the monitor numbers shown below to <F711: Monitor mode 1 display> to <F718: Monitor mode 8 display>. For details, refer to [8. 1. 1].

"93: Cumulative overcurrent time"

#### Memo

- Cumulative overcurrent time can be confirmed in [Monitor mode]. You can reset the monitor value to 0 with the setting of "15: Clear cumulative overcurrent time " in <tyP: Default setting>. For details, refer to [5. 2. 9].

#### Reference

- How to operate the operation panel -> Refer to [3. 1. 1].
- How to switch display mode on the operation panel -> Refer to [3. 1. 2].
- Procedure to change parameter setting -> Refer to [4. 2. 3]

## 6. 31 Forced run control in emergency

<F650: Forced run>

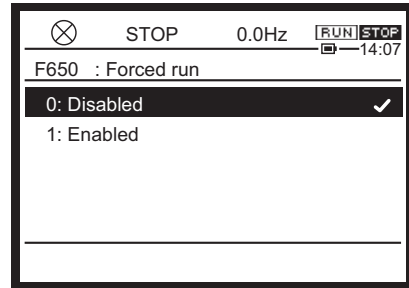

### ■ Function

With the forced run control, the motor runs at the specified speed in an emergency.

### ■ Parameter setting

Title	Parameter name	Adjustment range	Unit	Default setting
F650	Forced run	0: Disabled 1: Enabled		0
F294	Preset speed 15 / Forced run speed	LL - UL	Hz	0.0

### ■ Setting the parameters and input terminal

Set <F650: forced run> = "1: Enabled"

Set any of the function to the unused input terminal. For details, refer to [7. 2. 1].

You can perform the forced run or fire speed run with the setting of <F650> = "1" and an assigned input terminal is ON.

"56: Forced run"

- Once the input signal is ON, it is self-retained. The motor runs at the frequency set by <F294>.
- In case of a slight failure, the motor performs the forced run, in which the operation is continued.

"58: Fire speed run"

- Once the input signal is ON, it is self-retained. The motor performs the fire speed run at the frequency set by <F294>.

In both cases, to stop the running, the power circuit needs to be turned off.

During the forced run and the fire speed run, "FlrE" is displayed.

### ■ Signal output of forced run

Assign any of these to the unused output terminal. For details, refer to [7. 2. 2].

"138: During forced run"

"140: During fire speed run"

**Reference**

- How to operate the operation panel -> Refer to [3. 1. 1].
- How to switch display mode on the operation panel -> Refer to [3. 1. 2].
- Procedure to change parameter setting -> Refer to [4. 2. 3]
- Details on operation by external signals -> Refer to [Chapter 7].

# 6. 32 Frequency adjustment using external input (override function)

- <F660: Override adding input select>
- <F661: Override multiplying input select>
- <F729: Panel override multiplication gain>

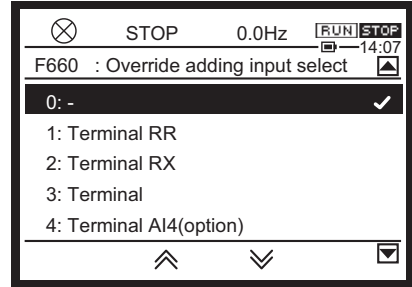

■ Function

You can make adjustment for adding or multiple to frequency command value by external signal.

■ Parameter setting

6

Title	Parameter name	Adjustment range	Unit	Default setting
F660	Override adding input select	0: - 1: Terminal RR 2: Terminal RX 3: Terminal II 4: Terminal AI4 (option) 5: Terminal AI5 (option) 6 - 9: - 10: Touch wheel 1 (power off or press OK to save) 11 - 14: - 15: Terminal Up/Down frequency 16: Pulse train 17: High resolution pulse train (option) 18/19: - 20: Embedded Ethernet 21: RS485 communication connector 1 22: RS485 communication connector 2 23: Communication option		0
F661	Override multiplying input select	0: - 1: Terminal RR 2: Terminal RX 3: Terminal II 4: Terminal AI4 (option) 5 - 11: - 12: F729 13 - 30: - 31: Terminal RR *1 32: Terminal RX *1 33: Terminal II *1 34: Terminal AI4 (option) *1 35 - 41: - 42: F729 *1		0

Title	Parameter name	Adjustment range	Unit	Default setting
F729	Panel override multiplication gain	-100 to +100	%	0

■ **Guideline for the setting**

The override functions calculate the frequency command value by means of the following expression:

- Frequency command value × (1+<F661> Input (%)/100) + <F660> Input (Hz)
- <F661> is limited to -100 to +100

However, when the setting value of <F661: Override multiplying input select> is \*1 in the table, use the following expression.

- Frequency command value × (<F661> Input (%)/100) + <F660> Input (Hz)
- <F661> is not limited

■ **Additive override**

An input override frequency is added to the frequency command value externally.

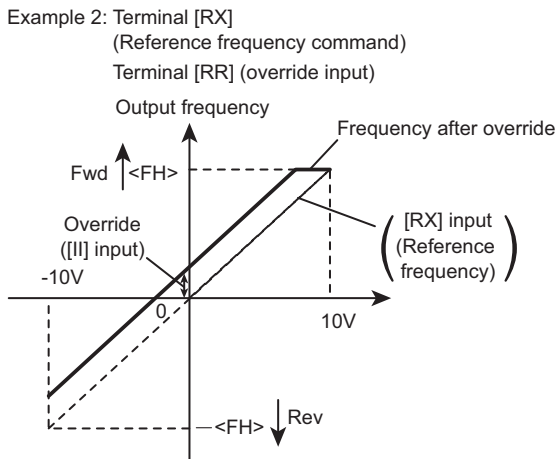
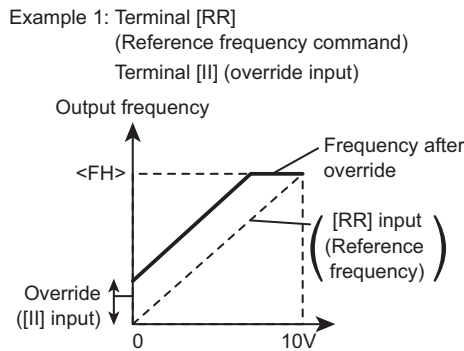

**Example 1: <F660>= "3: Terminal II", <F661>= "0: Disabled"**

Output frequency = Reference frequency + Override (terminal [II] input (Hz))

**Example 2: <F660>= "1: Terminal RR", <F661>= "0: Disabled"**

Output frequency = Reference frequency + Override (terminal [RR] input (Hz))

■ **Multiple override**

An input override frequency is added to the frequency command value externally.

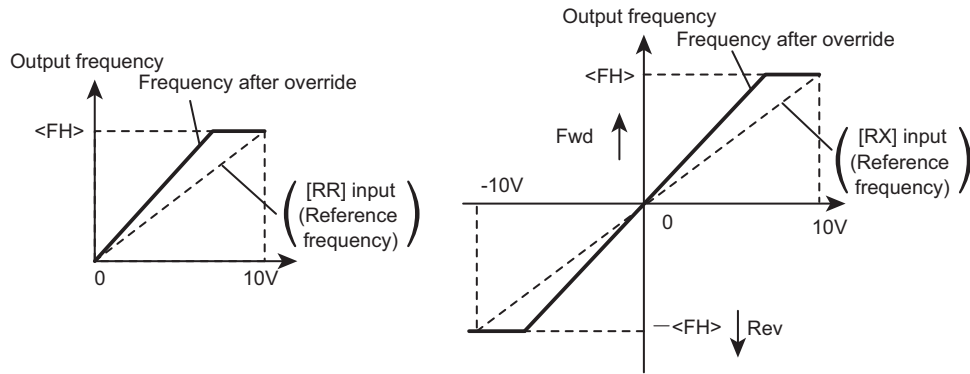

**Example 1: <F660>= "0: Disabled", <F661>= "3: Terminal II"**

<FM0d>= "1: Terminal RR", <FH>= "80.0", <UL>= "80.0"

terminal [RR] input

<F201>= "0", <F202>= "0.0", <F203>= "100", <F204>= "80.0"

terminal [II] input

<F216>= "0", <F220>= "0", <F218>= "100", <F221>= "100"

Output frequency = Reference frequency x {1 + Override (terminal [II] input (%)/100)}

**Example 2: <F660>=0 (disabled), <F661>=1 (terminal [RR])**

<FM0d>= "2: Terminal RX", <FH>= "80.0", <UL>= "80.0"

terminal [RX] input

<F210>= "0", <F211>= "0.0", <F212>= "100", <F213>= "80.0"

terminal [RR] input

<F201>= "0", <F205>= "0", <F203>= "100", <F206>= "100"

Output frequency = Reference frequency x {1 + Override (terminal [RR] input (%)/100)}

**Example 3**

Output frequency = Reference frequency x {1 + Override (<F729: Panel override multiplication gain> Setting value (%)/100)}

6

Reference

- How to operate the operation panel -> Refer to [3. 1. 1].
- How to switch display mode on the operation panel -> Refer to [3. 1. 2].
- Procedure to change parameter setting -> Refer to [4. 2. 3]
- Details on operation by external signals -> Refer to [Chapter 7].



## 6. 33 Adjustment parameters

### 6. 33. 1 Pulse output based on input cumulative power by a fixed integral value

- <F667: Pulse output step of input cumulative power>
- <F668: Pulse output width of input cumulative power>

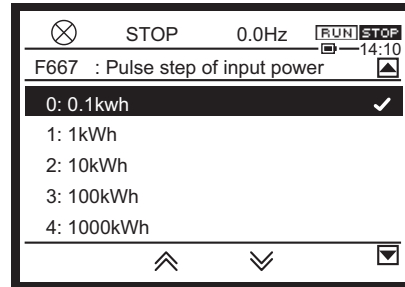

#### ■ Function

Every time the integral input power reaches the cumulative power unit set by <F667: Pulse output step of input cumulative power>, pulse signal can be output. You can display the power by pulse count without an external power meter.

Pulse output width is set by <F668: Pulse output width of input cumulative power>.

6

#### ■ Parameter setting

Title	Parameter name	Adjustment range	Unit	Default setting
F667	Pulse output step of input cumulative power	0: 1.0=1 kWh 1: 1.0=10 kWh 2: 1.0=100 kWh 3: 1.0=1000 kWh 4: 1.0=10000 kWh 5: 1.0=100000 kWh		1
F668	Pulse output width of input cumulative power	0.1 - 1.0	s	0.1

#### ■ Setting the parameters

This is a setting for pulse output from terminal [FP].

Set <F130: Terminal FP function 1> = "180: For input cumulative power"

Set the integral power unit with <F667: Pulse output step of input cumulative power>, and set the pulse output width with <F668: Pulse output step of input cumulative power>.

#### Reference

- How to operate the operation panel -> Refer to [3. 1. 1].
- How to switch display mode on the operation panel -> Refer to [3. 1. 2].
- Procedure to change parameter setting -> Refer to [4. 2. 3]
- Details on operation by external signals -> Refer to [Chapter 7].

## 6. 33. 2 Pulse train output

- <F669: Terminal FP switching>
- <F676: Terminal FP pulse train output function>
- <F677: Maximum pulse number of pulse train output>
- <F678: Pulse train output filter>

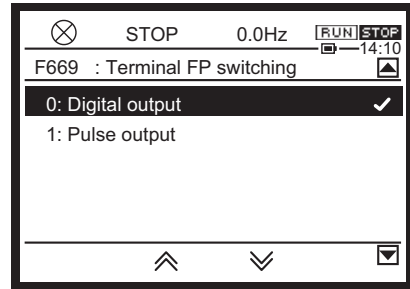

### ■ Function

Pulse trains can be output from terminal [FP]. Set the pulse output function and the number of pulses.

### ■ Parameter setting

Title	Parameter name	Adjustment range	Unit	Default setting
F669	Terminal FP switching	0: Digital output 1: Pulse output		0
F676	Terminal FP pulse train output function	0-149 *1		0
F677	Maximum pulse number of pulse train output	0.50 - 30.00	kpps	8.00
F678	Pulse train output filter	1 - 1000	ms	64

\*1 For details, refer to [11. 7].

### ■ Setting method

For example, to output frequency (0 - 60Hz) at 0 - 600 pulse, set as follows.

<FH>= "60.0", <F669>= "1", <F676>= "0", <F677>= "0.60"

When the item selected by <F676> has reached the value of the reference of maximum value, the number of pulse set by <F677: maximum pulse number of pulse train output> is output.

ON pulse width is a fixed width. When outputting the maximum number of pulses set by <F677>, the width is fixed at a value, where the duty ratio is 50%.

Therefore, the duty ratio varies according to the output pulse.

For example,

- <F677>="0.80" (kpps), ON pulse width = approx. 0.6 (ms)
- <F677>="1.00" (kpps), ON pulse width = approx. 0.5 (ms)
- <F677>="1.60" (kpps), ON pulse width = approx. 0.3 (ms)

Pulses below 15pps cannot be output.

**Reference**

- How to operate the operation panel -> Refer to [3. 1. 1].
- How to switch display mode on the operation panel -> Refer to [3. 1. 2].
- Procedure to change parameter setting -> Refer to [4. 2. 3]
- Details on operation by external signals -> Refer to [Chapter 7].

### 6. 33. 3 Analog output adjustment

- <F681: Terminal FM switching>
- <F682: Terminal FM inclination polarity>
- <F683: Terminal FM bias>
- <F684: Terminal FM filter>
- <F685: Terminal FM upper-limit level>
- <F686: Terminal AM switching>
- <F687: Terminal AM inclination polarity>
- <F688: Terminal AM bias>
- <F689: Terminal AM filter>
- <F690: Terminal AM upper-limit level>

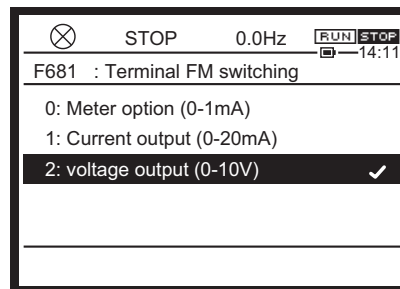

#### ■ Function

With the setting of <F681>, you can switch the output signal from terminal [FM] to 0 - 1mA<sub>dc</sub> output, 0 - 20mA<sub>dc</sub> output, and 0 - 10 V<sub>dc</sub> output. Default setting is 0 - 10V<sub>dc</sub> output. Similarly, the output signal from the terminal [AM] can be also switched.

#### ■ Parameter setting

Title	Parameter name	Adjustment range	Unit	Default setting
F681	Terminal FM switching	0: Meter option (0-1mA) 1: Current output (0-20mA) 2: Voltage output (0-10V)		2
F682	Terminal FM inclination polarity	0: Negative inclination (downward slope) 1: Positive inclination (upward slope)		1
F683	Terminal FM bias	-100.0 to +100.0	%	0.0
F684	Terminal FM filter	1 - 1000	ms	1
F685	Terminal FM upper-limit level	0.0 - 100.0	%	100.0
F686	Terminal AM switching	0: Meter option (0-1mA) 1: Current output (0-20mA) 2: Voltage output (0-10V)		2
F687	Terminal AM inclination polarity	0: Negative inclination (downward slope) 1: Positive inclination (upward slope)		1
F688	Terminal AM bias	-100.0 to 100.0	%	0.0
F689	Terminal AM filter	1 - 1000	ms	1
F690	Terminal AM upper-limit level	0.0 - 100.0	%	100.0

#### ■ Setting methods

To obtain 4 - 20 mA<sub>dc</sub> output, adjust <F683: Terminal FM bias> and <F688: Terminal AM bias>. When using the optional frequency meter (QS60T), set <F681> to "0" or F686 to "0".

■ Setting example

<F681>="1", <F691>="1", <F692>="0" (%)

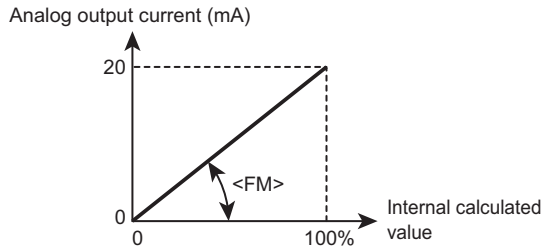

<F681>="1", <F691>="1", <F692>="20" (%)

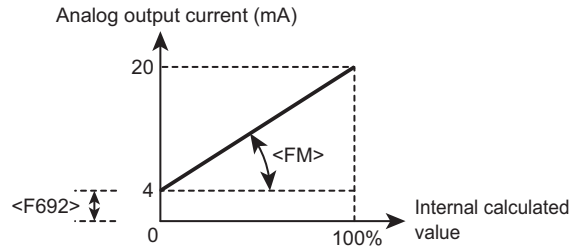

<F681>="1", <F691>="1", <F692>="100" (%)

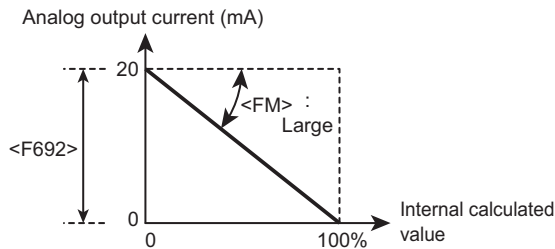

<F681>="1", <F691>="0", <F692>="100" (%)

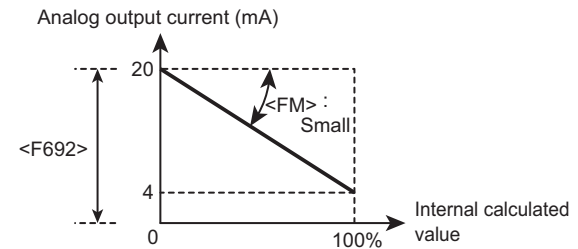

Set the inclination of analog output with <FM: Terminal FM adjustment> and <F671: Terminal AM adjustment>. For details of how to adjust, refer to [5. 2. 6].

Reference

- How to operate the operation panel -> Refer to [3. 1. 1].
- How to switch display mode on the operation panel -> Refer to [3. 1. 2].
- Procedure to change parameter setting -> Refer to [4. 2. 3]
- Details on operation by external signals -> Refer to [Chapter 7].

## 6. 34 Setting functions of operation panel

Lock or unlock the key operation of the operation panel and parameter setting.  
Also, set the display functions of the operation panel.

### 6. 34. 1 Lockout key operation and parameter setting

- <F700: Parameter reading&writing access lockout>
- <F730: Panel frequency setting lockout>
- <F731: Operation after disconnection detection during panel run>
- <F732: Panel Hand/Auto function lockout>
- <F733: Panel Run lockout>
- <F734: Panel emergency off lockout>
- <F735: Panel reset lockout>
- <F736: CMOD/FMOD change lockout during run>
- <F737: Panel keys lockout>
- <F738: Password setting>
- <F739: Password verification>

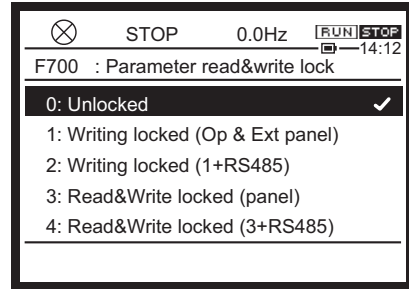

6

#### ■ Function

These parameters allow you to locked or unlocked operation on the operation panel and the change of parameters. Using these parameters, you can also lock various key operations to prevent malfunction.

Lock parameters with a password to prevent configuration.

#### ■ Parameter setting

Title	Parameter name	Adjustment range	Default setting
F700	Parameter reading&writing access lockout *1	0: Unlocked 1: Writing locked (Operation panel, Extension panel) 2: Writing locked (1+RS485) 3: Reading&Writing locked (Operation panel, Extension panel) 4: Reading&Writing locked (3+RS485)	0
F730	Panel frequency setting lockout	0: Unlocked 1: Locked 2: Unlocked after press OK	2
F731	Operation after disconnection detection during panel run *2	1: Continue running 2, 3: - 4: Trip	4
F732	Panel Hand/Auto function lockout *3	0: Unlocked 1: Locked	1
F733	Panel Run lockout	0: Unlocked 1: Locked	0
F734	Panel emergency off lockout	0: Unlocked 1: Locked	0

Title	Parameter name	Adjustment range	Default setting
F735	Panel reset lockout	0: Unlocked 1: Locked	0
F736	CMOd/FMOd change lockout during run	0: Unlocked 1: Locked	1
F737	Panel keys lockout *4	0: Unlocked 1: Locked 2: Locked only extension panel 3: Locked only operation panel	0
F738	Password setting *5	0: Disabled 1 - 9998 9999: Password was set	0
F739	Password verification	0: non-setting 1 - 9998 9999: Password was set	0

\*1 The setting of <F700>="2" and "4" is valid after reset (turning off power).

\*2 Enabled when run command is input from the operation panel.

\*3 <F732> is only for extended LED panel. <F750> is for LCD panel.

\*4 After setting <F737>. turn on the power again. The setting is valid after the power is turned on again.

\*5 The setting of <738>="9999" is valid after reset (turning off power).

■ **Selecting a setting value**

In [Standard mode], if you lock the frequency setting on the operation panel (<FC>, <FPId>, Preset speed), set <F730: Panel frequency setting lockout> to "1".

You cannot lock the setting with <F700>.

■ **Setting/clearing method of password when it is required for protection**

1) **Password setting method**

Parameters other than <F700>, <F738>, and <F739> cannot be changed when <F700> is set to "1" to "4".

When <F738> or <F739> is "0", a password has not been set. You can set a new password.

When <F738> or <F739> is "9999", a password has already been set.

If not set, select and register a number from "1" to "9998" for <F738> as a password. Do not forget your password as it is required to release the lock.



Important

- The lock cannot be released if you forget the password. Do not forget this password as we cannot retrieve it.

**Memo**

- The password cannot be set when <F700> = "0". Select a number other than 0 and then set the password.
- The password can be read out to parameter writer (optional device) until the power is off after setting <F738>. Please note that password will not be able to read out due to password protection after the power is off.

**2) Password clearing method**

When <F738> or <F739> is read out and the value is "9999", a password has already been set. The password has to be cleared in order to change parameters.

To <F739>, input the number registered to <F738> when the password was set.

If the password matches, "PASS" is displayed and the password is cleared.

If the password is incorrect, "FAIL" is displayed and the screen returns to <F739>.

The setting of <F700> can be changed after the password is cleared.

By setting <F700> to "0", settings of all the parameters are enabled.

**6**

Important

- You cannot try inputting <F739> for more than three times. If a wrong password has been input three times, setting is no longer possible. However, the number of times is reset after power is off.

- **Cancellation method of <F700> and <F737> lockout setting**

- 3) **Cancellation of <F700> lockout setting**

The setting of <F700> can be changed at any time, regardless of its setting value.

- 4) **Cancellation of <F737> lockout setting**

When the key operation lockout is set, press and hold down the [OK] key for 5 seconds or more.

The message "Undo" appears and this setting is canceled temporarily for the key operation.

To cancel this setting permanently, change the setting of <F737> directly.

- **Parameter setting unlocked with digital input**

When "110: Parameter writing unlocked" is assigned to the unused input terminal, setting of parameters is possible regardless of the setting of <F700: Parameter reading&writing access lockout>.

- **Parameter setting lockout with digital input**

If the following functions are assigned to the unused input terminal, parameter writing or reading is locked.

"200: Parameter writing locked"

"202: Parameter reading locked"



**Reference**

- How to operate the operation panel -> Refer to [3. 1. 1].
- How to switch display mode on the operation panel -> Refer to [3. 1. 2].
- Procedure to change parameter setting -> Refer to [4. 2. 3]
- Details on operation by external signals -> Refer to [Chapter 7].

## **6. 34. 2 Changing current/voltage display from percentage to unit (A/V)**

<F701: Current, voltage units select>

For details, refer to [5. 2. 7].

## **6. 34. 3 Displaying motor or line speed**

<F702: Free unit multiplication factor>

<F703: Target of free unit>

<F705: Free unit inclination polarity>

<F706: Free unit bias>

For details, refer to [5. 4. 3].

## 6. 34. 4 Changing variation steps of panel display

<F707: Step of panel setting>

<F708: Step of panel display>

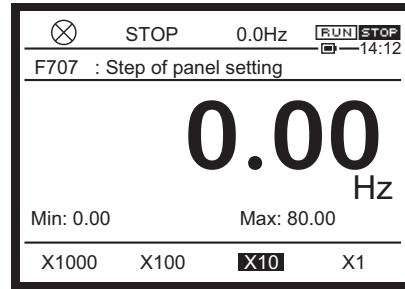

### ■ Function

The changeable step width can be changed at panel frequency setting.

This function is useful when only running with frequencies of intervals of 1 Hz, 5 Hz, and 10 Hz units.

### ■ Parameter setting

Title	Parameter name	Adjustment range	Unit	Default setting
F707	Step of panel setting	0.00: Disabled 0.01 - FH	Hz	0.00
F708	Step of panel display	0: Disabled 1 - 255		0

### ■ Caution when used

The settings of these parameters do not work when <F702: Free unit multiplication factor> is set.

When you set other than "0" to <F707> and increase the frequency by turning the touch wheel to the right, frequency will not be increased beyond this point and the "HI" message is displayed if the frequency is over <UL: Upper limit frequency> with just one more step rotation.

Similarly, when you decrease the frequency by turning the touch wheel to the left and if the frequency falls under <LL: Lower limit frequency> with just one more step rotation, the "LO" message is displayed in advance and the frequency cannot be lowered beyond this point.

### ■ Setting example

#### 1) <F707> = not "0.00", <F708> = "0: Disabled"

Under normal conditions, the frequency command value on the operation panel increases by 0.1 Hz when you turn the touch wheel to the right. If <F707> is not "0.00", the frequency command value will increase by the value with <F707> each time you turn the touch wheel to the right by 1 step. Similarly, the frequency command value on the operation panel will decrease by the value set with <F707> when you turn the touch wheel to the left by 1 step.

When the second decimal place of <F707> is 0, the second decimal place of the frequency command value is not displayed.

#### 2) When <F707> is not "0.00", and <F708> is not "0"

The value displayed on the panel can also be changed in steps.

Output frequency displayed on LCD screen = Internal output frequency x <F708>/<F707>

**■ Operation example****<F707> = "0.00: Disabled"**

By rotating the touch wheel by 1 step, the panel run frequency command value changes only by 0.1 Hz.

**<F707> = "10.00"**

Rotating the touch wheel by 1 step changes the panel run frequency command value in 10.00 Hz increments, from 0.00 up to 60.00 (Hz).

**<F707> = "1.00", <F708> = "1"**

By rotating the touch wheel by 1 step, the frequency command value changes in steps of 1Hz: 0 → 1 → 2 → ... → 60 (Hz) and also the value displayed on the LCD panel changes in steps of 1.

Use these settings to hide decimal fractions.

**Reference**

- How to operate the operation panel -> Refer to [3. 1. 1].
- How to switch display mode on the operation panel -> Refer to [3. 1. 2].
- Procedure to change parameter setting -> Refer to [4. 2. 3]

### **6. 34. 5 Selecting data displayed in [Standard mode]**

<F710: Standard mode display>

<F720: Standard mode display of extension panel>

<F723: Status area display of operation panel>

Different contents can be displayed on the operation panel of the inverter unit and the extension panel (optional).

You can set the content displayed on Status area on the operation panel.

For details, refer to [5. 4. 3].

### **6. 34. 6 Changing display in [Monitor mode]**

<F711: Monitor mode 1 display> to <F718: Monitor mode 8 display>

Change the display items in [Monitor mode].

For details, refer to [8. 1. 1].

## 6. 34. 7 Holding display in [Standard mode]

<F709: Hold function of standard mode>

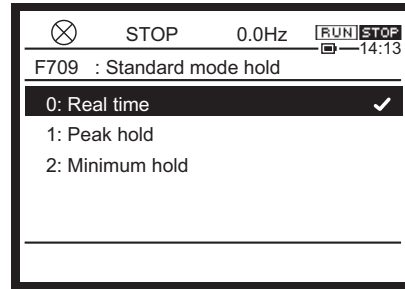

### ■ Function

The display in [Standard mode] can be held.

### ■ Parameter setting

Title	Parameter name	Adjustment range	Default setting
F709	Hold function of standard mode	0: Real time 1: Peak hold 2: Minimum hold	0

### ■ Selecting a setting value

#### 0: Real time

The contents selected with <F710: Standard mode display> are displayed.

#### 1: Peak hold

#### 2: Minimum hold

For peak hold values and minimum hold values, the maximum/minimum values in each operation cycle are displayed.

- When the motor is at a standstill, the values monitored last are held as they were until the motor is started the next time.
- The maximum and minimum values monitored after power is on are always displayed whether the motor is running or at a standstill.

### Reference

- How to operate the operation panel -> Refer to [3. 1. 1].
- How to switch display mode on the operation panel -> Refer to [3. 1. 2].
- Procedure to change parameter setting -> Refer to [4. 2. 3]
- Details on operation by external signals -> Refer to [Chapter 7].

## 6. 34. 8 Clearing run command

<F719: Run command clear select>

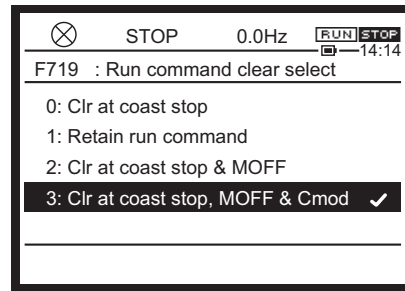

### ■ Function

This parameter is used to select whether the run command is retained or cleared when the following events occur during panel run or RS485 communication run.

- Coast stop with standby function (ST) is off (OFF display)
- Coast stop with coast command function (FRR) is on (OFF display)
- Power circuit undervoltage (MOFF) alarm

### ■ Parameter setting

Title	Parameter name	Adjustment range	Default setting
F719	Run command clear select	0: Clear at coast stop. Retain when MOFF occurs and CMOd is changed. 1: Retain run command. 2: Clear at coast stop and at MOFF. Retain when CMOd is changed. 3: Clear at coast stop, at MOFF and when CMOd is changed.	2

### ■ Difference between the settings

<F719> setting value	Coast stop	When power circuit undervoltage (MOFF) alarm occurred	When <CMOd> is changed
0	Run command clear	Retain run command	
1	Retain run command		
2	Run command clear		Retain run command
3	Run command clear		



Important

- If "PrA" alarm occurs when STO activated, run command is cleared regardless of the <F719> setting.

**Retain run command.**

Inverter restarts when coast stop is cleared after its occurrence.

Inverter restarts when power is supplied again when the power circuit undervoltage (MOFF) alarm occurs.

**Run command clear**

Inverter does not restart after coast stop or occurrence of the power circuit undervoltage (MOFF) alarm.

Press the [RUN] key to operate it again in panel run. Turn on the run command in RS485 communication run.

**■ Setting example of parameters of input terminals**

Set necessary function to the unused input terminal. For details, refer to [7. 2. 1].

"6: Standby"

"96: Coast stop"

**Reference**

- How to operate the operation panel -> Refer to [3. 1. 1].
- How to switch display mode on the operation panel -> Refer to [3. 1. 2].
- Procedure to change parameter setting -> Refer to [4. 2. 3]
- <CMod: Run command select> -> Refer to [5. 2. 1]
- Details of operation by external signals -> Refer to Chapter 7



## 6. 34. 9 Selecting panel stop pattern

<F721: Panel stop>

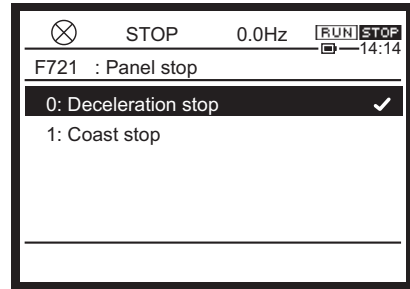

### ■ Function

This parameter is used to select a panel stop pattern by pressing the [STOP] key on the operation panel from Deceleration stop or Coast stop.

### ■ Parameter setting

Title	Parameter name	Adjustment range	Default setting
F721	Panel stop	0: Deceleration stop 1: Coast stop	0

6

### ■ Selecting a setting value

#### 0: Deceleration stop

The motor decelerate to a stop in the deceleration time set with <dEC: Deceleration time 1>.

#### 1: Coast stop

The inverter cuts off power supply to the motor. The motor comes to a stop after coasting for a while. Depending on the load, the motor may keep running for a longer time.

### Reference

- How to operate the operation panel -> Refer to [3. 1. 1].
- How to switch display mode on the operation panel -> Refer to [3. 1. 2].
- Procedure to change parameter setting -> Refer to [4. 2. 3]
- <dEC: Deceleration time 1> -> Refer to [5. 2. 4]

## 6. 34. 10 Setting torque command value in panel run

<F725: Panel torque command>

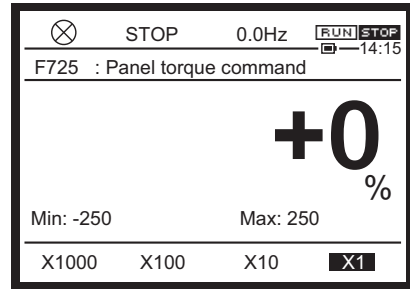

### ■ Function

This parameter is used to set a torque command value when torque control is performed in panel run.

### ■ Parameter setting

Title	Parameter name	Adjustment range	Unit	Default setting
F725	Panel torque command	-250 to +250	%	0

### ■ Guideline for the setting

<F725: Panel torque command> is enabled only when <F420: Torque command select> is "12" and acts as command value(%).

For details, refer to torque control (E6582106).

#### Reference

- How to operate the operation panel -> Refer to [3. 1. 1].
- How to switch display mode on the operation panel -> Refer to [3. 1. 2].
- Procedure to change parameter setting -> Refer to [4. 2. 3]
- Details on operation by external signals -> Refer to [Chapter 7].

## 6. 34. 11 Selecting panel display at power on

- <F790: Panel display at power on>
- <F791: 1st and 2nd characters of F790>
- <F792: 3rd and 4th characters of F790>
- <F793: 5th and 6th characters of F790>
- <F794: 7th and 8th characters of F790>
- <F795: 9th and 10th characters of F790>
- <F796: 11th and 12th characters of F790>
- <F797: 13th and 14th characters of F790>
- <F798: 15th and 16th characters of F790>

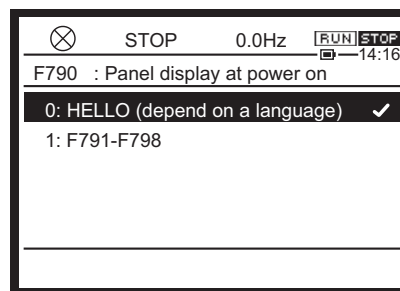

### ■ Function

These parameters allow you to change the characters on panel display at power on. By default setting, "HELLO" is displayed, but the word changes depending on the language selection. (The word equivalent of "Hello" for each language is displayed.)

### ■ Parameter setting

Title	Parameter name	Adjustment range	Default setting
F790	Panel display at power on	0: HELLO (depending on language selection) 1: F791 - F798 2, 3: -	0
F791	1st and 2nd characters of F790	0-FFFF	2d2d
F792	3rd and 4th characters of F790	0-FFFF	2d2d
F793	5th and 6th characters of F790	0-FFFF	2d2d
F794	7th and 8th characters of F790	0-FFFF	2d2d
F795	9th and 10th characters of F790	0-FFFF	2d2d
F796	11th and 12th characters of F790	0-FFFF	2d2d
F797	13th and 14th characters of F790	0-FFFF	2d2d
F798	15th and 16th characters of F790	0-FFFF	2d2d

### ■ Guideline for the setting

To display characters other than "HELLO", set <F790> to "1" and set the characters Changing variation steps of panel display displayed with <F791> to <F798>. Refer to "ASCII LED" of RS485 Communication Function Instruction Manual (E6582143) for setting of characters and set by hex number.

**Reference**

- How to operate the operation panel -> Refer to [3. 1. 1].
- How to switch display mode on the operation panel -> Refer to [3. 1. 2].
- Procedure to change parameter setting -> Refer to [4. 2. 3]

**6**

## 6. 35 Trace function

<F740: Trace>

<F741: Trace cycle>

<F742: Trace data 1>

<F743: Trace data 2>

<F744: Trace data 3>

<F745: Trace data 4>

For details, refer to Trace Function Instruction Manual (E6582134).

# 6. 36 Store cumulative power

<F748: Cumulative power save>  
 <F749: Cumulative power unit>

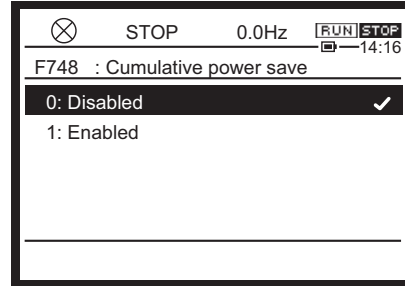

■ **Function**

At the main power off, the cumulative power can be stored, or the unit of the cumulative power can be selected.

Cumulative power can be monitored as monitor number 20 (input), 21 (output).

The parameter setting in detail is referred to section 8. 1. 1.

**6**

■ **Parameter setting**

Title	Parameter name	Adjustment range	Default setting
F748	Cumulative power save	0: Disabled 1: Enabled	0
F749	Cumulative power unit	0: 1.0=1 kWh 1: 1.0=10 kWh 2: 1.0=100 kWh 3: 1.0=1000 kWh 4: 1.0=10000 kWh 5: 1.0=100000 kWh	*1

\*1 Depending on capacity. For details, refer to [11. 6].

**Memo**

- Cumulative power monitor can be cleared by the signal to the input terminal. Assign "74: Cumulative power monitor clear" to the unused input terminal. For details, refer to [7. 2. 1].
- When monitor of cumulative power is saturated, change the value of F749.

**Reference**

- How to operate the operation panel -> Refer to [3. 1. 1].
- How to switch display mode on the operation panel -> Refer to [3. 1. 2].
- Procedure to change parameter setting -> Refer to [4. 2. 3]
- Details on operation by external signals -> Refer to [Chapter 7].

## 6. 37 Select EASY key function

<F750: EASY key function>  
LED extension panel option

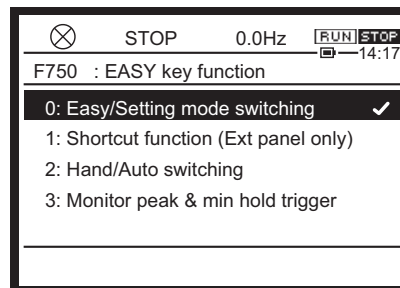

### ■ Function

This parameter is valid when the [EASY] key exists (extension panel, etc.)  
Since the operation panel of this inverter has no [EASY] key, values other than "0", "2" are invalid even if they are set with <F750>.

When the [EASY] key exists, the following four functions can be selected.

- [Easy mode]/[Setting mode] switching
- Shortcut key function
- Hand/Auto switching
- Monitor peak and minimum hold trigger

For options such as the extension panel, refer to [10. 3].

### ■ Parameter setting

Title	Parameter name	Adjustment range	Default setting
F750	EASY key function	0: Easy/Setting mode switching 1: Shortcut function (Extension panel only) 2: Hand/Auto switching 3: Monitor peak and minimum hold trigger	0

### ■ Difference between the settings

#### 0: Easy/Setting mode switching

When you press the [EASY] key while the inverter is stopped, the [Setting mode] and [Easy mode] can be switched.

In the default setting, the [Setting mode] is set at the time of power on.

The display of parameter setting varies depending on the mode. For details, refer to [4. 2. 1].

#### 1: Shortcut function (Extension panel only)

Parameters whose settings are frequently changed can be registered as shortcuts so that they can be read out easily with one operation.

Shortcuts are valid only in [Standard mode]

After setting <F750: EASY key function> to "1", read the setting value of the parameter to be stored and press the [EASY] key for two seconds or more. Now shortcut registration is complete.

To read out the parameter, press the [EASY] key.

#### 2: Hand/Auto switching

You can switch manual (operation panel) and automatic (remote) easily.

After setting <F750: EASY key function> to "2", switch the mode with the [EASY] key.

When <F295: Bumpless> is set to "1: Enabled", the mode can be switched even during run.

In manual, the [EASY] key lamp or  is lit .

In automatic, the inverter is operated with the operation method selected with <CMOD: Run command select>, <FMOD: Frequency command select 1>, etc.

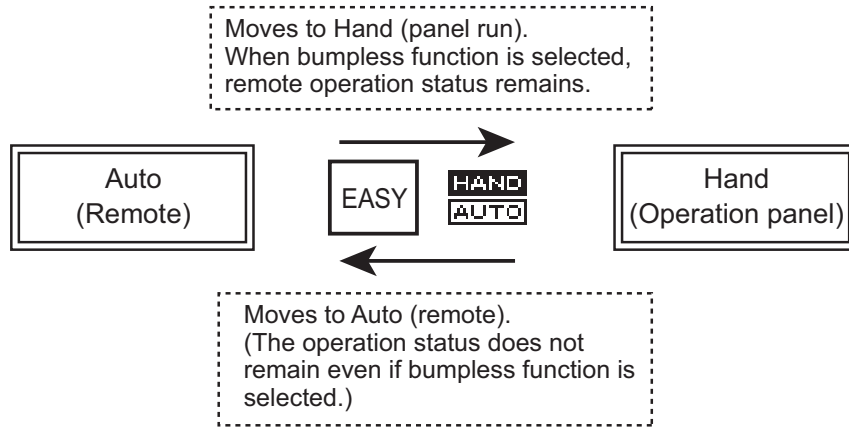

6

Memo

- Note that when you set <F750> to "0" in manual, the panel operation status remains and the setting is different from the one with <CMOD: Run command select>.

3: Monitor peak and minimum hold trigger

Set the peak hold and minimum hold triggers of <F709: Hold function of standard mode> with the [EASY] key.

The measurement of the minimum and maximum values set for <F709> starts at the instant when you press the [EASY] key after setting <F750: EASY key function> to "3".

The peak hold and minimum hold values are displayed in absolute values.

Reference

- How to operate the operation panel -> Refer to [3. 1. 1].
- How to switch display mode on the operation panel -> Refer to [3. 1. 2].
- Procedure to change parameter setting -> Refer to [4. 2. 3]
- <F295: Bumpless> of parameter -> Refer to [6. 13]
- <F709: Hold function of standard mode> of parameter -> Refer to [6. 34. 7]



## 6. 38 Communication functions

Use the communication and monitor functions in communication run using RS485 communication and various optional open networks.

### 6. 38. 1 Setting communication functions

#### ! WARNING



Mandatory action

- Set the parameter Communication time-out.  
If the parameter is not properly set, the inverter cannot be stopped immediately and this will result in injury and accidents.
- Install an emergency stop device and an interlock that are configured in accordance with the system specifications.  
If the inverter cannot be stopped immediately via communication or the extension panel, this will result in injury and accidents.

For details, refer to RS485 Communication Function Instruction Manual (E6582143).

6

- <F800: RS485 (1) baud rate>
- <F801: RS485 (1) parity>
- <F802: Inverter number (RS485 common)>
- <F803: RS485 (1) time-out time>
- <F804: RS485 (1) time-out operation>
- <F805: RS485 (1) transmission wait time>
- <F806: RS485 (1) inverter to inverter communication>
- <F807: RS485 (1) protocol>
- <F808: RS485 (1) time-out detection>
- <F809: Operation panel connection priority>
- <F810: Communication frequency point select>
- <F811: Communication point 1 input value>
- <F812: Communication point 1 frequency>
- <F813: Communication point 2 input value>
- <F814: Communication point 2 frequency>
- <F820: RS485 (2) baud rate>
- <F821: RS485 (2) parity>
- <F823: RS485 (2) time-out time>
- <F824: RS485 (2) time-out operation>
- <F825: RS485 (2) transmission wait time>
- <F826: RS485 (2) inverter to inverter communication>

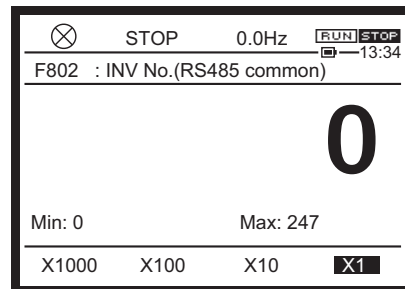
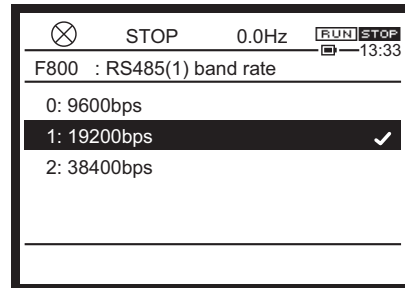

- <F827: RS485 (2) protocol>
- <F828: RS485 (2) time-out detection>
- <F829: RS485 (2) wiring type>
- <F830: MODBUS continuous address>
- <F856: Motor pole number for communication>
- <F870: Block write data 1>
- <F871: Block write data 2>
- <F875: Block read data 1>
- <F876: Block read data 2>
- <F877: Block read data 3>
- <F878: Block read data 4>
- <F879: Block read data 5>
- <F899: Communication option reset>

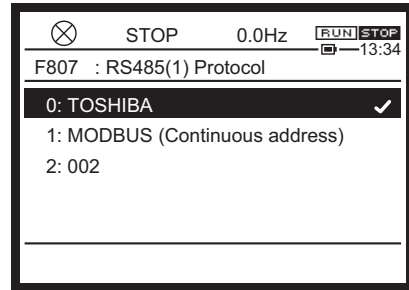

## ■ Function

RS485 communication is built-in as standard.

It can be connected to the host to create a network for transmitting data between multiple inverters.

An inverter-to-inverter communication function is also available.

# 6

## Communication function

### 1) Computer-linking functions

The following functions are enabled by data communication between the computer and inverter.

- Monitoring inverter status (such as the output frequency, current, and voltage)
- Sending Run/Stop and other control commands to the inverter
- Reading, editing and writing inverter parameter settings

### 2) Inverter-to-inverter communication function

This function allows you to set up a network that makes it possible to carry out proportional operation of multiple inverters. A host computer is not required.

One inverter serves as a leader and sends data selected with the parameter to other inverters that are followers in the same network. By using this function, you can configure a network for easy synchronized operation and proportional operation (setting of point frequency).

#### Time-out

This is a function to detect cable disconnection during communication.

When data is not sent even once to the inverter during a user-defined period of time, an inverter trip ("Err5" is displayed on the panel) or an alarm("t" is blinking) is output.

#### Broadcast communication

This is a function used to send a command (data write) to multiple inverters with single communication.

#### Communication protocol

Toshiba inverter protocol and a part of Modbus RTU protocol are supported.

■ **Parameter setting**

Title	Parameter name	Adjustment range	Unit	Default setting
F800	RS485 (1) baud rate *1	0: 9600 bps 1: 19200 bps 2: 38400 bps		1
F801	RS485 (1) parity *1	0: Disabled 1: Even parity 2: Odd parity		1
F802	Inverter number (RS485 common)	0 - 247		0
F803	RS485 (1) time-out time *2	0.0: Disabled 0.1 - 100.0	s	0.0
F804	RS485 (1) time-out operation *2	1: Continue running 2, 3: - 4: Trip 5: - 6: Trip after deceleration stop		0
F805	RS485 (1) transmission wait time	0.00 - 2.00	s	0.00
F806	RS485 (1) inverter to inverter communication *1	0: Follower (0Hz command when Leader fails) 1: Follower (continue running when Leader fails) 2: Follower (emergency off when Leader fails) 3: Leader (transmit frequency command) 4: Leader (transmit output frequency signal) 5: Leader (transmit torque command) 6: Leader (transmit output torque command)		0
F807	RS485 (1) protocol	0: TOSHIBA 1: MODBUS		0
F808	RS485 (1) time-out detection	0: Always 1: Run command and frequency command by communication are enabled. 2: During run by communication		1
F809	Operation panel connection priority *3	0: By the parameter setting 1: Connect to connector 1 2: Connect to connector 2		1
F810	Communication frequency point select	0: Disabled 1: RS485 (1) 2: RS485 (2) 3: Communication option 4: Embedded Ethernet		0
F811	Communication point 1 input value	0-100	%	0
F812	Communication point 1 frequency	0.0-FH	Hz	0.0
F813	Communication point 2 input value	0-100	%	100

**6**

Title	Parameter name	Adjustment range	Unit	Default setting
F814	Communication point 2 frequency	0.0-FH	Hz	50.0/60.0 *4
F820	RS485 (2) baud rate *1	0: 9600 bps 1: 19200 bps 2: 38400 bps		1
F821	RS485 (2) parity *1	0: Disabled 1: Even parity 2: Odd parity		1
F823	RS485 (2) time-out time *2	0.0: Disabled 0.1 - 100.0	s	0.0
F824	RS485 (2) time-out operation *2	1: Continue running 2, 3: - 4: Trip 5: - 6: Trip after Deceleration stop		0
F825	RS485 (2) transmission wait time	0.00 - 2.00	s	0.00
F826	RS485 (2) inverter to inverter communication *1	0: Follower (0Hz command when Leader fails) 1: Follower (continue running when Leader fails) 2: Follower (emergency off when Leader fails) 3: Leader (transmit frequency command) 4: Leader (transmit output frequency signal) 5: Leader (transmit torque command) 6: Leader (transmit output torque command)		0
F827	RS485 (2) protocol	0: TOSHIBA 1: MODBUS		0
F828	RS485 (2) time-out detection	0: Always 1: Run command and frequency command by communication are enabled. 2: During run by communication		1
F829	RS485 (2) wiring type	0: 2-wire 1: 4-wire		0
F830	MODBUS continuous address	0: Disabled 1: Enabled		0
F856	Motor pole number for communication	1: 2 pole 2: 4 pole 3: 6 pole 4: 8 pole 5: 10 pole 6: 12 pole 7: 14 pole 8: 16 pole		2
F870	Block write data 1	0: Disabled 1: Communication command 1		0
F871	Block write data 2	2: Communication command 2 3: Frequency command 4: TB output 5: Analog output 6: Speed command by communication		0

Title	Parameter name	Adjustment range	Unit	Default setting
F875	Block read data 1	0: Disabled 1: Status information 2: Output frequency 3: Output current 4: Output voltage 5: Alarm information 6: PID feedback value 7: Input terminal monitor 8: Output terminal monitor 9: Terminal RR monitor 10: Terminal RX monitor 11: Terminal II monitor 12: Input voltage (DC detection) 13: Speed feedback frequency 14: Torque 15: My function output monitor 1 16: My function output monitor 2 17: My function output monitor 3 18: My function output monitor 4 19: Free memorandum 20: Motor speed 21: Input power 22: Output power 23: Trip information		0
F876	Block read data 2			0
F877	Block read data 3			0
F878	Block read data 4			0
F879	Block read data 5			0
F899	Communication option reset	0: - 1: Reset option and inverter		0

\*1 Valid after the setting is changed and the power is turned off and on again.

\*2 The setting contents are as follows.

- Disabled: The inverter does not trip even if a communication error occurs.
- Trip: The inverter trips when communication time-over occurs, and "Err5" is displayed.
- Alarm: When communication time-over occurs, an alarm can be output from the output terminal. Assign the output terminal function "78" (RS485 communication time-out) (79 is inversion output) to the output terminal.

\*3 When using RS485 communication, set <F809>="0".

\*4 Depending on the setup menu. Refer to [11. 10].

■ **Communication option**

Refer to [10. 3. 5] and [10. 3. 6] for options connected to RS485 communication connectors.

To use these options, set <F805: RS485 (1) transmission wait time > to "0.00".

Reference	<ul style="list-style-type: none"> <li>• How to operate the operation panel -&gt; Refer to [3. 1. 1].</li> <li>• How to switch display mode on the operation panel -&gt; Refer to [3. 1. 2].</li> <li>• Procedure to change parameter setting -&gt; Refer to [4. 2. 3]</li> </ul>
-----------	---

## 6. 38. 2 Using RS485 communication

### ■ Operation by RS485 communication

To run/stop the inverter by RS485 communication, select "3: RS485 communication (connector 1)" or "4: RS485 communication (connector 2)" with <CMOd: Run command select>.

To issue frequency commands by RS485 communication, select "21: RS485 communication (connector 1)" or "22: RS485 communication (connector 2)" with <FMd: Frequency command select 1>.

Run commands and frequency commands by communication have priority over those from the operation panel and terminals. Therefore, run commands and frequency commands from communication can be enabled regardless of the settings of <CMOd> and <FMd>.

However, when "48" (Communication priority cancel) of input terminal function selection is assigned to the input terminal and a signal is input externally, perform panel run with the setting of <CMOd> and <FMd>.

When "2: Hand/Auto switching " is selected with <F750: EASY key function>, you can switch the operation panel run and communication run with the [HAND/AUTO] key of the operation panel.

### ■ Transmission specifications

Item	Specifications	
Communication protocol	TOSHIBA inverter protocol	MODBUS-RTU protocol
Interface	RS485 compliant	
Transmission scheme	Half duplex [Serial bus type (Line terminations resistor necessary at both ends of system)]	
Wiring	2-wire	
Transmission distance	500 m max. (total length)	
Connection terminals	32 max. (including upper host computer) Inverters connected in the system: 32 max.	
Synchronization scheme	Start-stop synchronization	
Communication baud rate	9600 bps - 38.4 kbps	
Character transmission	ASCII mode: JIS X0201 8-bit (ASCII) Binary mode: Binary codes fixed to 8 bits	Binary codes fixed to 8 bits
Error detecting scheme 1	Parity: Even/Odd/Non parity (selectable using a parameter)	
Error detecting scheme 2	Checksum	CRC
Stop bit length	Received by inverter: 1bit/Sent by inverter: 2 bits	
Order of bit transmission format	Least significant bit transmitted first	
Character transmission format	11-bit characters (Stop bit =1, with parity)	
Inverter Number	ASCII mode: 0 - 99 Binary mode: 0 - 63 (3Fh)	1 - 247

Item	Specifications	
Broadcast communication	Inverter Number should be set to ASCII mode: ** (*? or ?? (?=0-9) is available) Binary mode: 255 (0FFh)	Inverter Number should be set to 0
Frame length	Variable	
Error correction	Disabled	
Response monitoring	Disabled	
Other	Inverter operation at communication time-over: Select from trip/alarm/none - When alarm is selected, an alarm is output from the output terminal. - When trip is selected, "Err5" blinks on the panel.	

■ **Connection example when using computer link function**

1) **Independent communication**

Here is a case where an operation frequency command is sent from the host computer to inverter No.3.

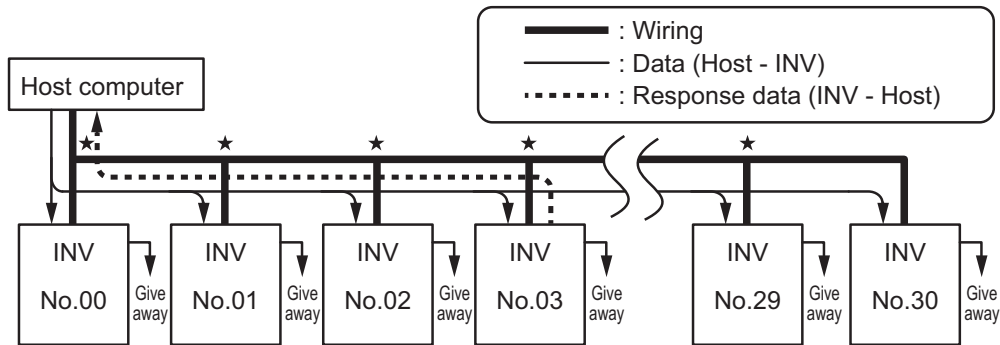

INV: Inverter

Give away: Only the inverter with the selected inverter number conducts data processing. All other inverters, even if they have received the data, give it away and stand by to receive the next data.

★ : Use the terminal block, etc. to branch the cable.

1. Data is sent from the host computer.
2. Data from the computer is received at each inverter, and the inverter numbers are checked.
3. The command is decoded and processed only by the inverter with the selected inverter number.
4. The selected inverter responds by sending the processing results, together with its own inverter number, to the host computer.
5. As a result, only the selected inverter starts operating in accordance with the operation frequency command sent by the host computer.

2) **Broadcast communication**

Here is a case where a frequency command is sent via a broadcast from the host computer.

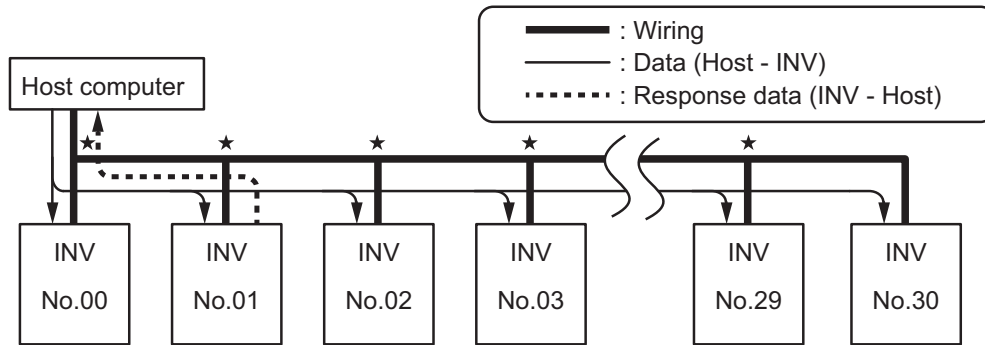

INV: Inverter

★ : Use the terminal block, etc. to branch the cable.

1. Data is sent from the host computer.
2. Data from the computer is received at each inverter and the inverter numbers are checked.
3. When "\*" is added to the position of an inverter number, it is judged a broadcast. The command is decoded and processed.
4. To prevent data conflicts, only inverters where "\*" is overwritten to "0" can reply with data to the host computer.
5. As a result, all inverters are operating with the broadcast operation frequency command.

6

Specify inverter numbers by group for group broadcasts.

This is a function only for ASCII mode. For parity mode, refer to RS485 Communications Function Instruction Manual (E6582143).

For example, when "\*1" is set, inverters "01", "02", "03", "04", ..., "09" can be broadcast to.

In this case, the inverter specified as "01" can reply.

■ Connection example of inverter-to-inverter communication

One inverter is a leader and the other inverters are followers.

Here is a case where all follower inverters connected operate at the same frequency as the leader inverter.

No frequency point is set.

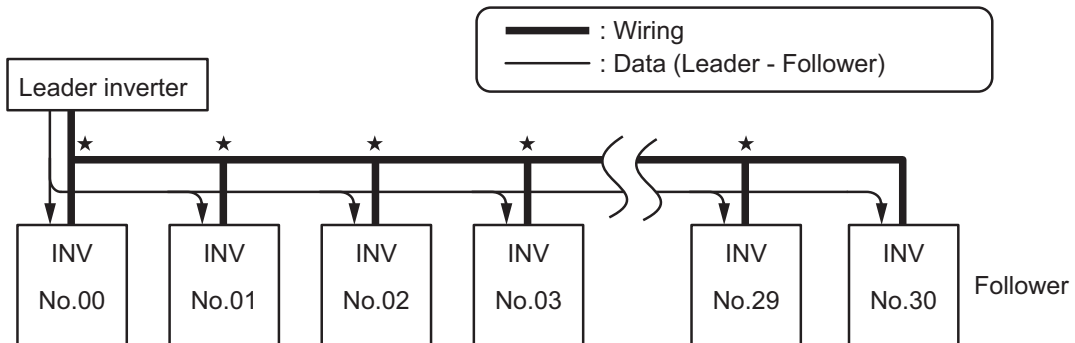

INV: Inverter

★ : Use the terminal block, etc. to branch the cable.

1. The leader inverter transmits frequency command data to its follower inverters.



2. The follower inverters calculate a frequency reference from the data received and save the frequency calculated.
3. As a result, all follower inverters operate at the same frequency as the leader inverter.

The leader inverter always sends frequency command data to its follower inverters.

The follower inverters are always on standby so that they can receive an frequency command from the leader inverter at any time.

### 6. 38. 3 Input numbers as memorandum

<F880: Free memorandum>

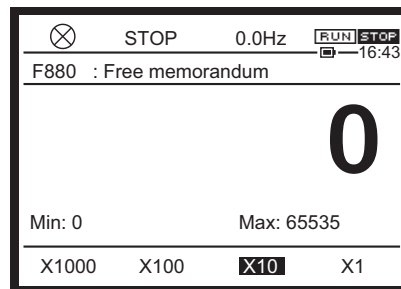

■ **Function**

You can enter the identification number, etc. for easier management and maintenance of the inverter.

■ **Parameter setting**

Title	Parameter name	Adjustment range	Default setting
F880	Free memorandum	0 - 65535	0

**Reference**

- How to operate the operation panel -> Refer to [3. 1. 1].
- How to switch display mode on the operation panel -> Refer to [3. 1. 2].
- Procedure to change parameter setting -> Refer to [4. 2. 3].

## 6. 39 Step-out detection of PM motor

<F910: PM step-out detection current level>

<F911: PM step-out detection time>

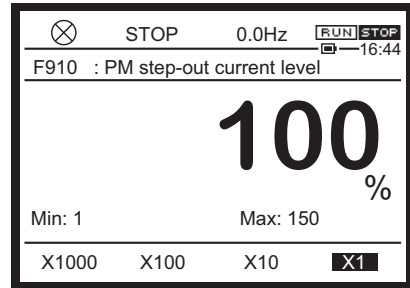

### ■ Function

If the PM motor steps out and if the exciting current increases (it increases in such a case) and remains over the value set by <F910: PM step-out detection current level > for the period of time set by <F911: PM step-out detection time>, the inverter will judge the motor to be stepping out and trip it.

At that time, the trip message "SOUT" is displayed.

### ■ Parameter setting

Title	Parameter name	Adjustment range	Unit	Default setting
F910	PM step-out detection current level	1 - 150	%	100
F911	PM step-out detection time	0.00: Disabled 0.01 - 2.55	s	0.00



Important

- When using an PM motor, consult your Toshiba distributor, since the inverter is not compatible with all types of PM motors.
- The inverter may fail to detect step-out in some cases, because it uses an electrical method to detect step-out. To avoid detection failures, you are recommended to install a mechanical step-out detector.

### Memo

- For setting of PM motor parameter, refer to [6. 23. 2].

### Reference

- How to operate the operation panel -> Refer to [3. 1. 1].
- How to switch display mode on the operation panel -> Refer to [3. 1. 2].
- Procedure to change parameter setting -> Refer to [4. 2. 3]

## 6. 40 Traverse function

<F980: Traverse operation>

<F981: Traverse Acc time>

<F982: Traverse Dec time>

<F983: Traverse step>

<F984: Traverse jump step>

For details, refer to Traverse Function Instruction Manual (E6582100).

## 6. 41 My function

My function <A800> - <A847>, <A900> - <A982>

For details, refer to My Function Instruction Manual (E6582114).



# 7

## Operating using external signals

I

II

You can operate the inverter by inputting external signals to the control terminals. The run commands are input to the digital input terminals by the ON/OFF signals. The frequency commands are input to the analog input terminals by the voltage signals (potentiometer, etc.), or the current signals. This chapter explains how to set the parameters required to operate the inverter using external signals and how to assign the functions to the terminals.

### 7.1 How to externally operate the inverter

You can operate the inverter by external signals. The parameter setting items vary depending on the operation method. Before setting the parameters, be sure to check the operation method (how to input run commands and frequency commands).

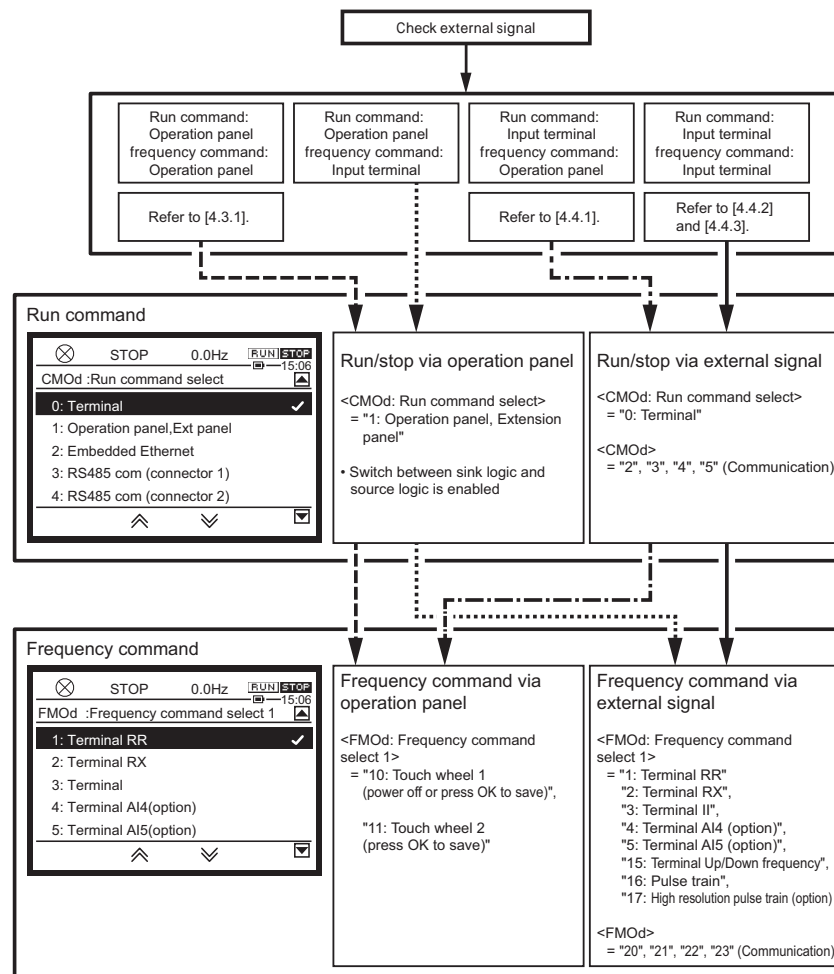

For operation by communication, refer to "Communication Function Instruction Manual" (E6582143) and [6. 38].

1

2

3

4

5

6

7

8

9

10

11

12

13

14

15

16

## 7.2 Applied operation by I/O signals

You can assign the functions to the digital input terminals. The assigned functions can be switched for operation.

Also, you can assign the functions to the digital output terminals and the relay logic output terminals to output signals to external equipment.

For the digital terminals, sink logic and source logic can be switched with the slide switch [SW1]. For details, refer to [2. 3. 5].

### 7.2.1 Setting the functions to the input terminals (for sink logic)

Signals are input to the digital input terminals from an external programmable controller. The signals are used for operating the inverter and switching the functions.

The digital input terminal functions can be selected from a variety of functions, thus allowing flexible compatibility with system design.

■ Configuration of the control terminal block

7



■ Function setting for the digital input terminals

Terminal symbol	Title	Parameter name	Adjustment range	Default setting
F	F111	Terminal F function 1	0 - 203 *1	2
	F151	Terminal F function 2		0
	F155	Terminal F function 3		0
R	F112	Terminal R function 1	0 - 203 *1	4
	F152	Terminal R function 2		0
	F156	Terminal R function 3		0



Terminal symbol	Title	Parameter name	Adjustment range	Default setting
RES	F113	Terminal RES function 1	0 - 203 *1	8
	F153	Terminal RES function 2		0
	F157	Terminal RES function 3		0
S1	F114	Terminal S1 function 1	0 - 203 *1	10
	F154	Terminal S1 function 2		0
	F158	Terminal S1 function 3		0
S2	F115	Terminal S2 function	0 - 203	12
S3	F116	Terminal S3 function	0 - 203	14
S4	F117	Terminal S4 function *2	0 - 203	16
	F146	Terminal S4 input select	0: Digital input 1: Pulse train input 2: PG input	0
S5	F118	Terminal S5 function *3	0 - 203	118
	F147	Terminal S5 input select	0: Digital input 1: Pulse train input 2: PG input	0
DI11	F119	Terminal DI11 function *4	0 - 203	0
DI12	F120	Terminal DI12 function *4	0 - 203	0
DI13	F121	Terminal DI13 function *4	0 - 203	0
DI14	F122	Terminal DI14 function *4	0 - 203	0
DI15	F123	Terminal DI15 function *4	0 - 203	0
DI16	F124	Terminal DI16 function *4	0 - 203	0
F	F140	Terminal F response time	1 - 1000 (ms)	1 *5
R	F141	Terminal R response time	1 - 1000 (ms)	1 *5
RES	F142	Terminal RES response time	1 - 1000 (ms)	1 *5
S1	F143	Terminal S1 response time	1 - 1000 (ms)	1 *5
S2 - S5	F144	Terminal S2-S5 response time	1 - 1000 (ms)	1 *5
DI11-DI16	F145	Terminal DI11-DI16 response time *4	1 - 1000 (ms)	1 *5

\*1 If a variety of functions are assigned to a terminal, the assigned functions will be simultaneously enabled.

\*2 When you use the terminal [S4] as digital input, set <F146: Terminal S4 input select> = "0: Digital input".

\*3 When you use the terminal [S5] as digital input, set <F147: Terminal S5 input select> = "0: Digital input".

\*4 Indicated optional terminals on IO extension 1 (ETB013Z), refer to E6582128.

\*5 If stable operation cannot be achieved because of noise of the frequency setting circuit, etc., increase the values for <F140: Terminal F response time> to <F145: Terminal DI11-DI16 response time>.

**Memo**

- To always enable the functions, assign the functions to <F110: Always active function 1>, <F127: Always active function 2>, and <F128: Always active function 3>.

■ **Connecting methods**

1) **A contact input (for sink logic)**

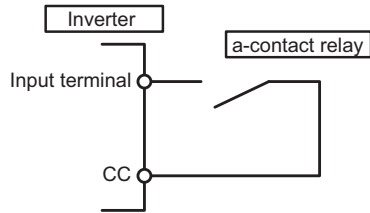

2) **Transistor output connection (for sink logic)**

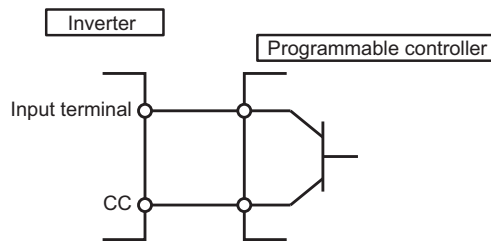

You can connect the input terminal and the terminal [CC] (common) to the programmable controller output (non-logic switch) for control purposes. Use this connecting method for forward/reverse run, or preset speed operation, etc.

■ **Usage example: 3-wire operation (one-push operation)**

The use of the 3-wire operation function allows the one-push signal (reset logic signal) to be self-held during operation. No external sequence circuit is needed.

To perform 3-wire operation, make setting as shown below:

- <F110: Always active function 1> = "6: Standby"
- <CMOd: Run command select> = "0: Terminal"
- <F111: Terminal F function 1> = "2: Fwd run" (default setting)
- <F112: Terminal R function 1> = "4: Rev run"(default setting)

Also, assign "50: 3-wire operation hold/stop" ("51" for inversion input) to the input terminal.

The following shows an example for assignment to the terminal [S2].

- <F115: Terminal S2 function > = "50"

For sink logic

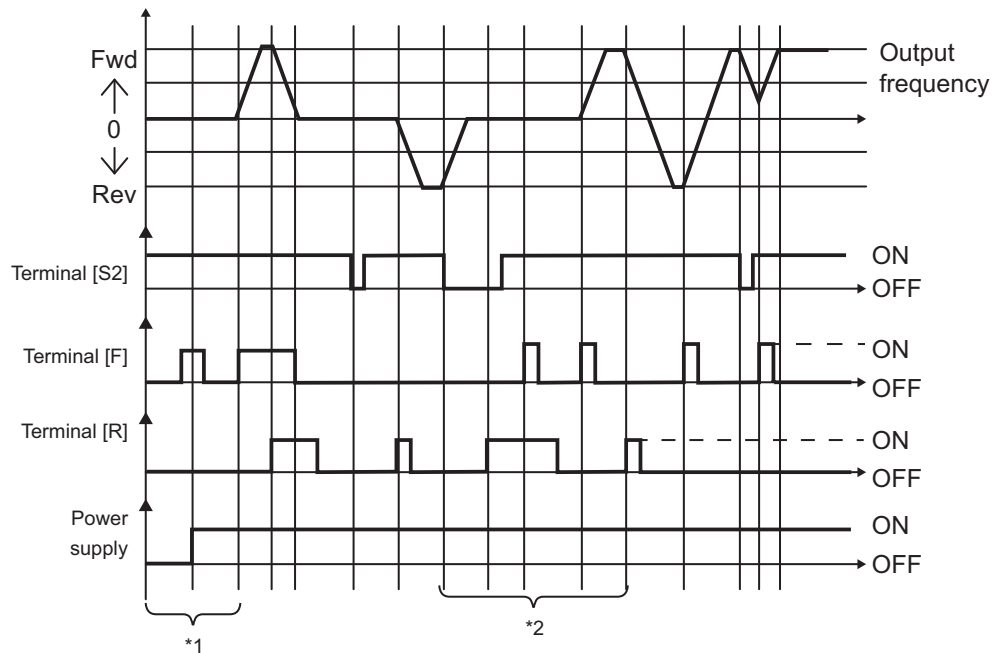
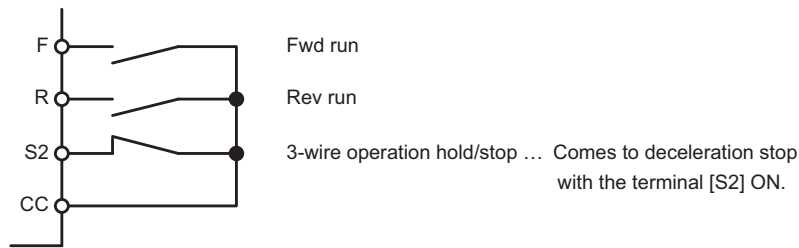

\*1 -> If each terminal is turned ON before the power is turned ON, it is very dangerous because sudden movement occurs. Therefore, the input terminal ON signal is ignored at power on. After power on, turn ON the input terminal again.

\*2 -> Turn ON 3-wire operation hold/stop(HD), and then Fwd run (F) or Rev run (R).

Even if Fwd run or Rev run is turned ON while 3-wire operation hold/stop is OFF, the signal will be ignored. Even if 3-wire operation hold/stop is turned ON while Rev run is ON, operation will not occur. Even if Fwd run is turned ON in that state, operation will not occur. Turn OFF Fwd run and Rev run, and then turn ON Fwd run or Rev run.

The input terminal function of 3-wire operation hold/stop is held only for Fwd run (F) and Rev run (R). Keep in mind that the other functions are not held when Fwd run or Rev run is used in combination of any other function. For example, when Fwd run and Preset speed switching 1 (SS1) are assigned, Fwd run is held, but not Preset speed switching 1.

**Memo**

- If the jog run command is input during 3-wire operation, operation will stop.
- Keep in mind that DC braking continues even if a run command is input during DC braking.

## ■ List of the digital input terminal functions

Setting value		Input terminal function	Setting value		Input terminal function
Positive logic	Negative logic (Inverse)		Positive logic	Negative logic (Inverse)	
0	1	No function	84	85	Terminal R2 output hold
2	3	Fwd run	88	89	Terminal Up frequency *1
4	5	Rev run	90	91	Terminal Down frequency *1
6	7	Standby	92	93	Terminal Up, Down frequency clear *1
8	9	Reset 1	94	95	Dancer correction OFF
10	11	Preset speed switching 1	96	97	Coast stop
12	13	Preset speed switching 2	98	99	Fwd/Rev
14	15	Preset speed switching 3	100	101	Run/Stop
16	17	Preset speed switching 4	102	103	Commercial power run switching
18	19	Jog run	104	105	FMOd/F207 priority switching
20	21	Emergency off	106	107	Terminal II priority
22	23	DC braking	108	109	Terminal operation priority
24	25	Acc/Dec switching 1	110	111	Parameter writing unlocked
26	27	Acc/Dec switching 2	112	113	Speed control/Torque control switching
28	29	V/f switching 1	114	115	External equipment counter
30	31	V/f switching 2	116	117	PID 1, 2 switching
32	33	Stall prevention switching/Torque limit switching 1	118	119	Preset speed switching 5
34	35	Torque limit switching 2	120	121	Quick deceleration 1
36	37	PID control OFF	122	123	Quick deceleration 2
38	39	Pattern operation 1	124	125	Preliminary excitation
40	41	Pattern operation 2	126	127	Brake
42	43	Pattern operation continuation	130	131	Brake answerback
44	45	Pattern operation start	134	135	Traverse operation
46	47	External thermal trip	136	137	Rescue operation
48	49	Communication priority cancel	138	139	Pump control switching
50	51	3-wire operation hold/stop	140	141	Fwd slowdown
52	53	PID differential/integral reset	142	143	Fwd stop
54	55	PID plus/minus switching	144	145	Rev slowdown
56	57	Forced run	146	147	Rev stop

Setting value		Input terminal function	Setting value		Input terminal function
Positive logic	Negative logic (Inverse)		Positive logic	Negative logic (Inverse)	
58	59	Fire speed run	148	149	Fwd/Rev slowdown
60	61	Dwell operation	150	151	Hit and stop clear
62	63	Synchronized Acc/Dec	152	153	No.2 motor switching
64	65	My function start	154	155	External PID3 enabled
66	67	Offline auto-tuning	156	157	External PID4 enabled
68	69	Speed control gain switching	158	159	Reset 2
70	71	Servo lock	162	163	External PID3 differential/integral reset
72	73	Simple positioning	164	165	External PID3 plus/minus switching
74	75	Cumulative power monitor clear	170	171	External PID4 differential/integral reset
76	77	Trace trigger	172	173	External PID4 plus/minus switching
78	79	Light-load high-speed operation inhibited	176	177	Pump control release
80	81	Terminal FP output hold	200	201	Parameter writing locked
82	83	Terminal R1 output hold	202	203	Parameter reading locked

\*1 Enabled only for <FMOd: Frequency command select 1> = "15: Terminal Up/Down frequency".  
 The frequency command range is 0.0 to <FH: Maximum frequency>. The acceleration/deceleration time is the time set for <ACC: Acceleration time 1> and <dEC: Deceleration time 1> unless acceleration/deceleration switching is performed.

For details on the input terminal functions, refer to [11. 5].

## 7. 2. 2 Setting the functions to the output terminals (for sink logic)

Signals are output to external equipment from the inverter.

You can select the functions for the digital output terminals and the relay logic output terminals from a variety of output terminal functions.

Two types of functions can be set for the terminals [FP] and [R1A]-[R1C]. In this case, output is possible when the two functions are simultaneously turned ON or either of the functions is turned ON.

### ■ Configuration of the control terminal block



7

### ■ Use conditions

Functions of the terminals  
[FLA]-[FLB]-[FLC]:  
Set in parameter <F132> \*1

Functions of the terminals [R1A]-[R1C],  
[R2A]-[R2C]:  
Set in parameter <F130>, <F137> \*1

Functions of the terminal [FP]:  
Set in parameter <F131>, <F138> \*1

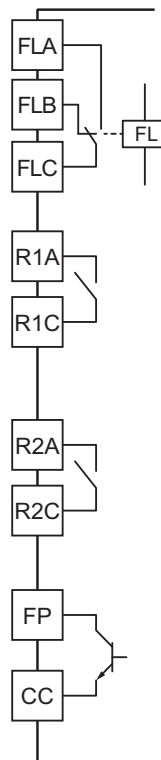

\*1 With relay contact output, chattering (momentary ON/OFF of contact) is generated by external factors of the vibration and the impact, etc. In particular, please set a filter of 10 ms or more, or timer for measures when connecting it directly to the input unit of the programmable controller. When connecting the programmable controller, use the terminal [FP] if possible.

■ Function setting for the output terminals

Terminal symbol	Title	Parameter name	Adjustment range	Default setting
FP	F130	Terminal FP function 1 *1	0 - 255	6
	F137	Terminal FP function 2 *1		255
	F669	Terminal FP switching	0: Digital output 1: Pulse train output	0
FLA-FLB-FLC	F132	Terminal FL function	0 - 255	10
R1A-R1C	F133	Terminal R1 function 1	0 - 255	4
	F138	Terminal R1 function 2		255
R2A-R2C	F134	Terminal R2 function	0 - 255	254
DQ11	F159	Terminal DQ11 function *2	0 - 255	254
DQ12	F160	Terminal DQ12 function *2	0 - 255	254
R4	F161	Terminal R4 function *2	0 - 255	254
R5	F162	Terminal R5 function *2	0 - 255	254
R6	F163	Terminal R6 function *2	0 - 255	254
R1	F135	Terminal R1 delay time	0.0 - 60.0 (s)	0.0
R2	F136	Terminal R2 delay time	0.0 - 60.0 (s)	0.0
FP R1A-R1C	F139	Terminal FP, R1 logic select	0: F130 and F137, F133 and F138 1: F130 and F137, F133 or F138 2: F130 or F137, F133 and F138 3: F130 or F137, F133 or F138	0

\*1 When you use the terminal [FP] as digital input, set <F669: Terminal FP switching> = "0: Digital output".

\*2 Indicated optional terminals on IO extension 1 (ETB013Z) or IO extension 2 (ETB014Z), refer to E6582128 or E6582129.

■ Assigning two types of functions to a terminal

For the output terminals, you can assign two types of functions to the terminals [FP] and [R1A]-[R1C].

1) Logical product (AND): Signals are output when two types of functions are simultaneously turned ON.

In case of the terminal [FP], when you set <F139: Terminal FP, R1 logic select> = "0" or "1", signals are output when the functions set for <F130: Terminal FP function 1> and <F137: Terminal FP function 2> are simultaneously turned ON.

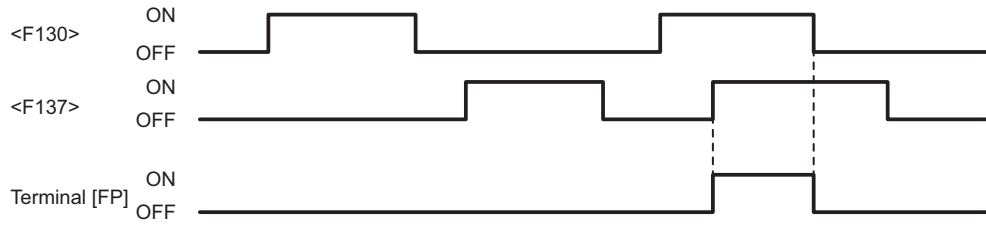

In case of the terminals [R1A]-[R1C], when you set <F139> = "0" or "2", signals are output when the functions set for <F133: Terminal R1 function 1> and <F138: Terminal R1 function 2> are simultaneously turned ON.

**2) Logical sum (OR): Signals are output when either of two functions is turned ON.**

In case of the terminal [FP], when you set <F139: Terminal FP, R1 logic select> = "2" or "3", signals are output when either of the functions set for <F130: Terminal FP function 1> and <F137: Terminal FP function 2> is turned ON.

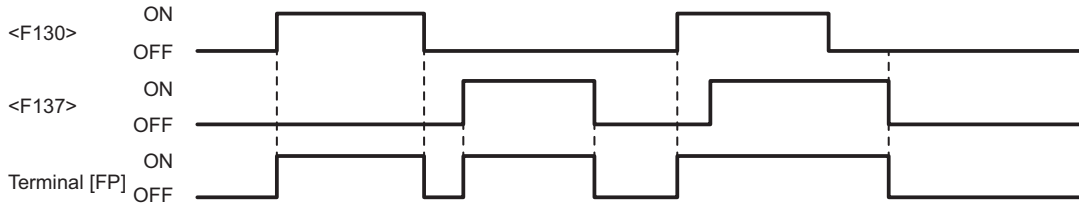

In case of the terminals [R1A]-[R1C], when you set <F139> = "1" or "3", signals are output when either of the functions set for <F133: Terminal R1 function 1> and <F138: Terminal R1 function 2> is turned ON.

7

■ **Holding the signal output ON state (output hold function)**

You can set the terminals [FP], [R1A]-[R1C], and [R2A]-[R2C] so that the ON state is held even after the condition is changed when a signal is once turned ON.

When a corresponding output terminal is turned ON while the input terminal where the output hold function is assigned is ON, the ON state is held.

Assign the following function numbers to any open input terminals.

- For holding the output of the terminal [FP]: "80: Terminal FP output hold"
- For holding the output of the terminal [R1A]: "82: Terminal R1 output hold"
- For holding the output of the terminal [R2A]: "84: Terminal R2 output hold"

■ **Usage example 1: Outputting running signals**

The following shows examples for outputting running signals.

Running signals can be output from the terminals [R1A]-[R1C] as default setting.

- <F133: Terminal R1 function 1> = "4: Low-speed signal" (default setting)
- <F100: Low-speed signal output frequency> = "0.0" (Hz) (default setting)

For the output terminal function of "4: Low-speed signal", signals are output when the output frequency becomes the frequency set for <F100: Low-speed signal output frequency> or more. In case of <F100> = "0.0" (Hz), the signal is turned ON when the frequency is output. Therefore, you can use it as a running signal.



■ Usage example 2: Outputting braking signals

The following shows an example for outputting the excitation/release signals for the electromagnetic brake.

To output the braking signals from the terminals [R1A]-[R1C], make setting as follows:

- <F133: Terminal R1 function 1> = "4: Low-speed signal" (default setting)
- <F100: Low-speed signal output frequency> = "2.5" (Hz) (setting example)

Set <F100> to the value for the motor rated slip.

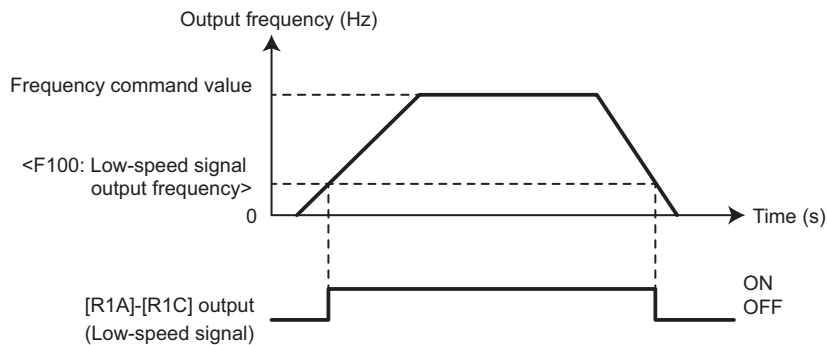

■ List of the digital output terminal functions

Setting value		Output terminal function	Setting value		Output terminal function
Positive logic	Negative logic (Inverse)		Positive logic	Negative logic (Inverse)	
0	1	Lower limit frequency (LL)	116	117	Failure signal 4
2	3	Upper limit frequency (UL)	118	119	Stop positioning completion
4	5	Low-speed signal	120	121	During sleep
6	7	Acc/Dec completed	122	123	During synchronized Acc/Dec
8	9	Specified frequency attainment	124	125	During traverse operation
10	11	Failure signal 1	126	127	During traverse Dec
12	13	Failure signal 2	128	129	Parts replacement alarm
14	15	Overcurrent (OC) pre-alarm	130	131	Overtorque (OT) pre-alarm
16	17	Inverter overload (OL1) pre-alarm	132	133	Frequency command 1/ Frequency command 2
18	19	Motor overload (OL2) pre-alarm	134	135	Failure signal 3
20	21	Overheat (OH) pre-alarm	136	137	Hand/Auto
22	23	Overvoltage (OP) pre-alarm	138	139	During forced run
24	25	Main circuit undervoltage (MOFF) alarm	140	141	During fire speed run
26	27	Undercurrent (UC) alarm	142	143	Undertorque alarm
28	29	Overtorque (OT) alarm	144	145	PID1, 2 frequency command agreement

**7**

Setting value		Output terminal function	Setting value		Output terminal function
Positive logic	Negative logic (Inverse)		Positive logic	Negative logic (Inverse)	
30	31	Braking resistor overload (OLr) pre-alarm	150	151	PTC input pre-alarm
32	33	Emergency off trip	152	153	During Safe Torque Off (STO)
34	35	During retry	154	155	Analog input disconnecting alarm
36	37	Pattern operation end	156	157	Terminal F ON/OFF
38	39	PID deviation limit	158	159	Terminal R ON/OFF
40	41	Run/Stop	160	161	Cooling fan replacement alarm
42	43	Serious failure	162	163	Number of starting alarm
44	45	Slight failure	164	165	Light load detection 2
46	47	Commercial power/Inverter Switching 1	166	167	During Acc
48	49	Commercial power/Inverter Switching 2	168	169	During Dec
50	51	During cooling fan run	170	171	During constant speed run
52	53	During jog run	172	173	During DC braking
54	55	During terminal run	174	175	During hit and stop
56	57	Cumulative run time alarm	176	177	During run including servo lock
58	59	Communication option communication time-out	178	179	During servo lock
60	61	Fwd/Rev run	180	181	For input cumulative power
62	63	Ready for run 1	182	183	Shock monitoring alarm
64	65	Ready for run 2	184	185	Number of external equipment starting alarm
68	69	During brake	186	187	V/f switching status 1
70	71	During alarm or pre-alarm	188	189	V/f switching status 2
72	73	During Fwd speed limit	190	191	Cooling fan fault alarm
74	75	During Rev speed limit	192	193	Embedded Ethernet communication time-out
76	77	Inverter healthy output	194 - 201		Calendar 1 - 4
78	79	RS485 communication time-out	202	203	During PID2 control
92	93	Designated data bit 0	204	205	During External PID3 control
94	95	Designated data bit 1	206	207	External PID3 deviation limit
106	107	Light load detection 1	208	209	During External PID4 control
108	109	Heavy load detection	210	211	External PID4 deviation limit
110	111	During positive torque limit	212	213	Pump control

Setting value		Output terminal function	Setting value		Output terminal function
Positive logic	Negative logic (Inverse)		Positive logic	Negative logic (Inverse)	
112	113	During negative torque limit	222 - 253		My function output 1 - 16
114	115	For external relay of rush current suppression	254	255	254: Always OFF 255: Always ON

The setting items in the table are as follows:

- Alarm: Indicates an alarm output where the inverter or external equipment may be damaged if it continues.
- Pre-alarm: Indicates an alarm output almost at the trip level.

For positive logic

- "ON": Indicates that the digital output transistor or the relay is ON.
- "OFF": Indicates that the digital output transistor or the relay is OFF.

For negative logic

- "ON": Indicates that the digital output transistor or the relay is OFF.
- "OFF": Indicates that the digital output transistor or the relay is ON.

For details on the output terminal functions and the levels, refer to [11. 6].

## 7.3 Frequency commands by the analog signals

You can input voltage signals and current signals to the analog input terminals as a frequency command.

### 7.3.1 Inputting frequency commands by analog signals

You can select four types of analog signals as a frequency command signal.

- Potentiometer
- 0 - 10 Vdc
- 4(0) - 20 mAdc
- -10 to +10 Vdc

For how to fine adjust the analog signals and output frequencies, refer to [6. 6. 3].

#### ■ Configuration of the control terminal block



#### ■ Analog input terminal function settings

Terminal symbol	Title	Parameter name	Adjustment range	Default setting
RR	F201	RR point 1 input value	0 - 100 (%)	0
	F202	RR point 1 frequency	0.0 - 590.0 (Hz)	0.0
	F203	RR point 2 input value	0 - 100 (%)	100
	F204	RR point 2 frequency	0.0 - 590.0 (Hz)	50.0/60.0 *1

7

Terminal symbol	Title	Parameter name	Adjustment range	Default setting
RX	F210	RX point 1 input value	-100 to 100 (%)	0
	F211	RX point 1 frequency	0.0 - 590.0 (Hz)	0.0
	F212	RX point 2 input value	-100 to 100 (%)	100
	F213	RX point 2 frequency	0.0 - 590.0 (Hz)	50.0/60.0 *1
	F107	Terminal RX input voltage select	0: 0 to +10 V 1: -10 to +10 V	0
II	F216	II point 1 input value	0 - 100 (%)	20
	F217	II point 1 frequency	0.0 - 590.0 (Hz)	0.0
	F218	II point 2 input value	0 - 100 (%)	100
	F219	II point 2 frequency	0.0 - 590.0 (Hz)	50.0/60.0 *1
AI4	F222	AI4 point 1 input value *2	-100 to 100 (%)	0
	F223	AI4 point 1 frequency *2	0.0 - 590.0 (Hz)	0.0
	F224	AI4 point 2 input value *2	-100 to 100 (%)	100
	F225	AI4 point 2 frequency *2	0.0 - 590.0 (Hz)	50.0/60.0 *1
	F148	Terminal AI4 input select *2	1: Voltage input (0 - 10 V) 2: Voltage input (-10 to +10 V) 3: Current input (0 - 20 mA) 4: PTC input 5: PT100 (2-wire) input 6: PT100 (3-wire) input 7: PT1000 (2-wire) input 8: PT1000 (3-wire) input 9: KTY84 input	1
AI5	F228	AI5 point 1 input value *2	-100 to 100 (%)	0
	F229	AI5 point 1 frequency *2	0.0 - 590.0 (Hz)	0.0
	F230	AI5 point 2 input value *2	-100 to 100 (%)	100
	F231	AI5 point 2 frequency *2	0.0 - 590.0 (Hz)	50.0/60.0 *1
	F149	Terminal AI5 input select *2	1: Voltage input (0 to 10V) 2: Voltage input (-10 to +10 V) 3: Current input (0 - 20 mA) 4: PTC input 5: PT100 (2-wire) input 6: PT100 (3-wire) input 7: PT1000 (2-wire) input 8: PT1000 (3-wire) input 9: KTY84 input	1

**7**

Terminal symbol	Title	Parameter name	Adjustment range	Default setting
Common	F209	Analog input filter	1: Disabled 2 - 1000 (ms)	1 *3
	A959	Analog input function target 11	0: Disabled 1: Terminal RR 2: Terminal RX 3: Terminal II 4: Terminal AI4 5: Terminal AI5	
	A961	Analog function setting destination 11	0: Disabled 1: Acc/Dec rate (ACC.dEC etc.) 2: Upper limit frequency (UL) 3: Acc multiplication factor (FH/ACC etc.) 4: Dec multiplication factor (FH/dEC etc.) 5: Manual torque boost (vb etc.) 6: Stall prevention level (F601 etc.) 7: Motor OL protection current (tHrA) 8: Speed control response (F460 etc.) 9: Droop gain (F320 etc.) 10: PID proportional gain (F362 etc.) 11: Base frequency voltage (VL etc.) 12 - 20: -	
	A962	Analog input function target 21	Same as A959	
	A964	Analog function setting destination 21	Same as A961	

\*1 The default setting value is depending on the setup menu. Refer to [5. 3. 10].

\*2 Indicated optional terminals on IO extension 1 (ETB013Z), refer to E6582128.

\*3 If stable operation cannot be achieved because of noise of the frequency command circuit, etc., increase the value for <F209: Analog input filter>.

For details on switching two types of analog signals for operation, refer to [5. 4. 1].

### 7. 3. 2 Inputting the frequency commands by potentiometer/voltage (0 - 10 Vdc)

Connect a potentiometer (1 k - 10 kΩ) between the terminals [PP]-[RR]-[CC] to input frequency commands.

Divide the reference voltage (10 Vdc) of the terminal [PP] using a potentiometer to input the voltage of 0 - 10 Vdc between the terminals [RR]-[CC].

You can also directly input a voltage signal of 0 - 10 Vdc between the terminals [RR]-[CC] without using a potentiometer.

#### ■ Setting example

The following shows an example of how to externally input the run commands to the digital input terminals, and how to input the frequency commands using a potentiometer.

The frequency shall be 0 Hz at the minimum setting of a potentiometer, and 60 Hz at the maximum setting of a potentiometer.

- <CMOD: Run command select> = "0: Terminal"
- <FMOD: Frequency command select 1> = "1: Terminal RR"
- <F201: RR point 1 input value> = "0" (%) (default setting)
- <F202: RR point 1 frequency> = "0" (Hz) (default setting)
- <F203: RR point 2 input value> = "100" (%) (default setting)
- <F204: RR point 2 frequency> = "60" (Hz) (default setting)

For the characteristics of input voltages and output frequencies, set at two points of <F201> and <F202>, and <F203> and <F204>. The reference for 100% of the input value is 10 V.

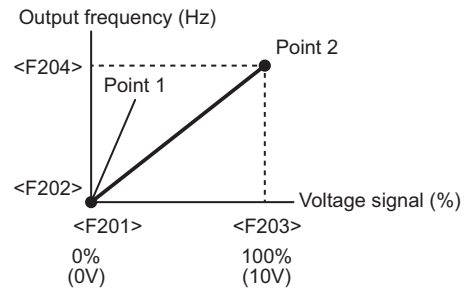
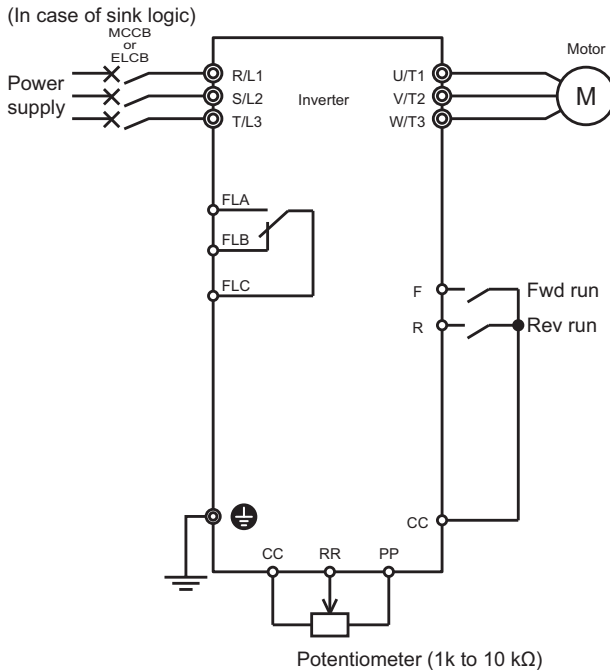

### 7. 3. 3 Inputting the frequency commands by current (4 - 20 mAdc)

Input the current signal of 4(0) - 20 mAdc between the terminals [II]-[CC].

#### ■ Setting example

The following shows an example of how to externally input the run commands to the digital input terminals with a current input of 4 - 20 mAdc.

The frequency shall be 0 Hz for the minimum input of 4 mA, and 60 Hz for the maximum input of 20 mA.

- <CMOD: Run command select> = "0: Terminal"
- <FMOD: Frequency command select 1> = "3: Terminal II"
- <F216: II point 1 input value> = "20" (%) (default setting)
- <F217: II point 1 frequency> = "0" (Hz) (default setting)
- <F218: II point 2 input value> = "100" (%) (default setting)
- <F219: II point 2 frequency> = "60" (Hz) (default setting)

For the characteristics of input currents and output frequencies, set at two points of <F216> and <F217>, and <F218> and <F219>. The reference for 100% of the input value is 20mA.

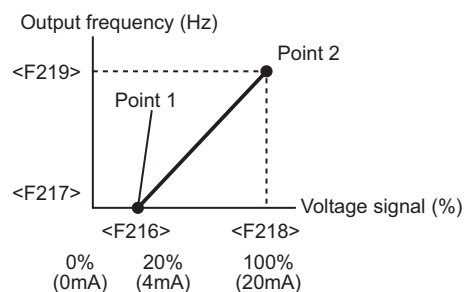
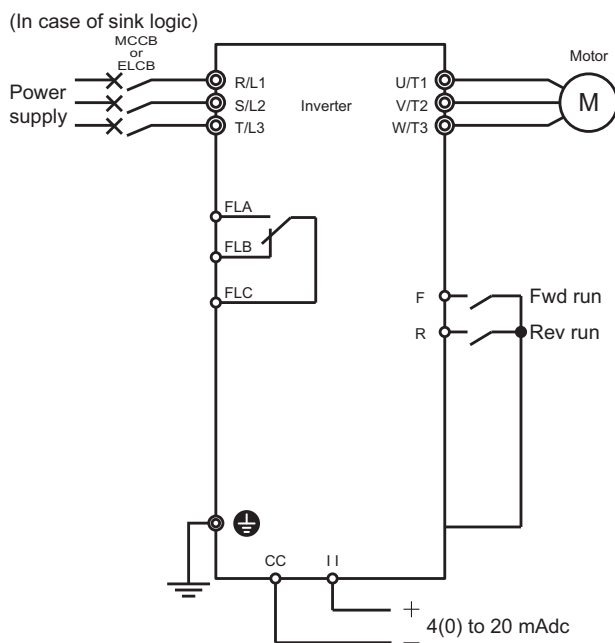

7



### 7.3.4 Inputting frequency commands by voltage (-10 to +10 Vdc)

Input the voltage signal of -10 to +10 Vdc between the terminals [RX]-[CC].

You can also input a voltage of 0 - 10 Vdc. Set <F107: Terminal RX input voltage select> = "0: 0 to +10 V".

#### ■ Setting example

The following shows an example of how to externally input the run commands to the digital input terminals with a voltage input of -10 to +10 V.

The frequency shall be 0 Hz at 0 V, and 60 Hz at +10 V. At this time, the frequency becomes 60 Hz in reverse run at -10 V.

- <CMOD: Run command select> = "0: Terminal"
- <FM0d: Frequency command select 1> = "2: Terminal RX"
- Set <F107: Terminal RX input voltage select> = "1: -10 to +10 V".
- <F210: RX point 1 input value> = "0" (%) (default setting)
- <F211: RX point 1 frequency> = "0" (Hz) (default setting)
- <F212: RX point 2 input value> = "100" (%) (default setting)
- <F213: RX point 2 frequency> = "60" (Hz) (default setting)

For the characteristics of input currents and output frequencies, set at two points of <F210> and <F211>, and <F212> and <F213>. The reference for 100% of the input value is 10 V.

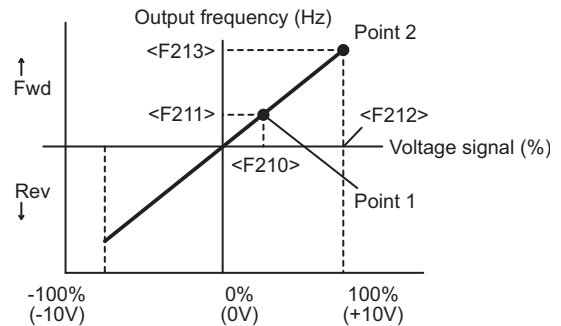
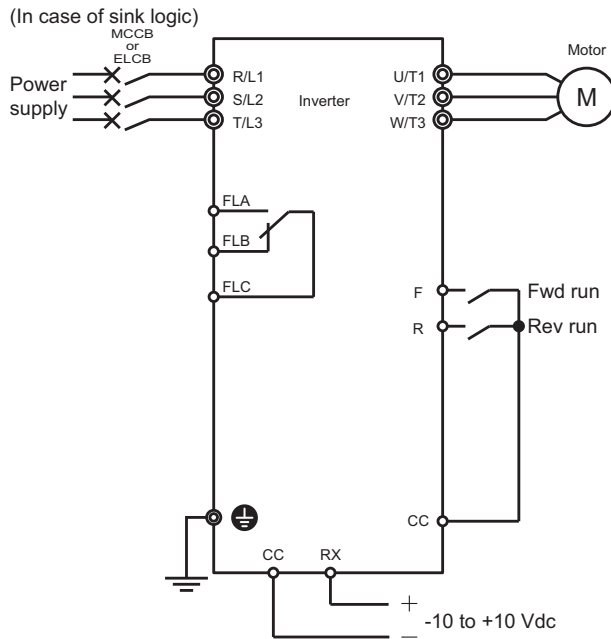



# 8

## Monitoring operation status

I

II

In [Monitor mode], the operation status of the inverter, ON/OFF information of input/output terminals, trip record, etc. are displayed.

This chapter explains the display contents of [Monitor mode].

Furthermore, display at the time of occurrence of a trip and causes and remedies are also introduced.

1

2

3

4

5

6

7

8

9

10

11

12

13

14

15

16

### 8.1 Screen display of [Monitor mode]

For the outline of screen display of [Monitor mode], refer to [3. 1. 2] "■Screen display of [Monitor mode]".

#### 8.1.1 Operation Status monitor

When [Standard mode] is displayed on the LCD screen during run, press the [F4] key or press [ESC] key twice to switch to [Monitor mode].

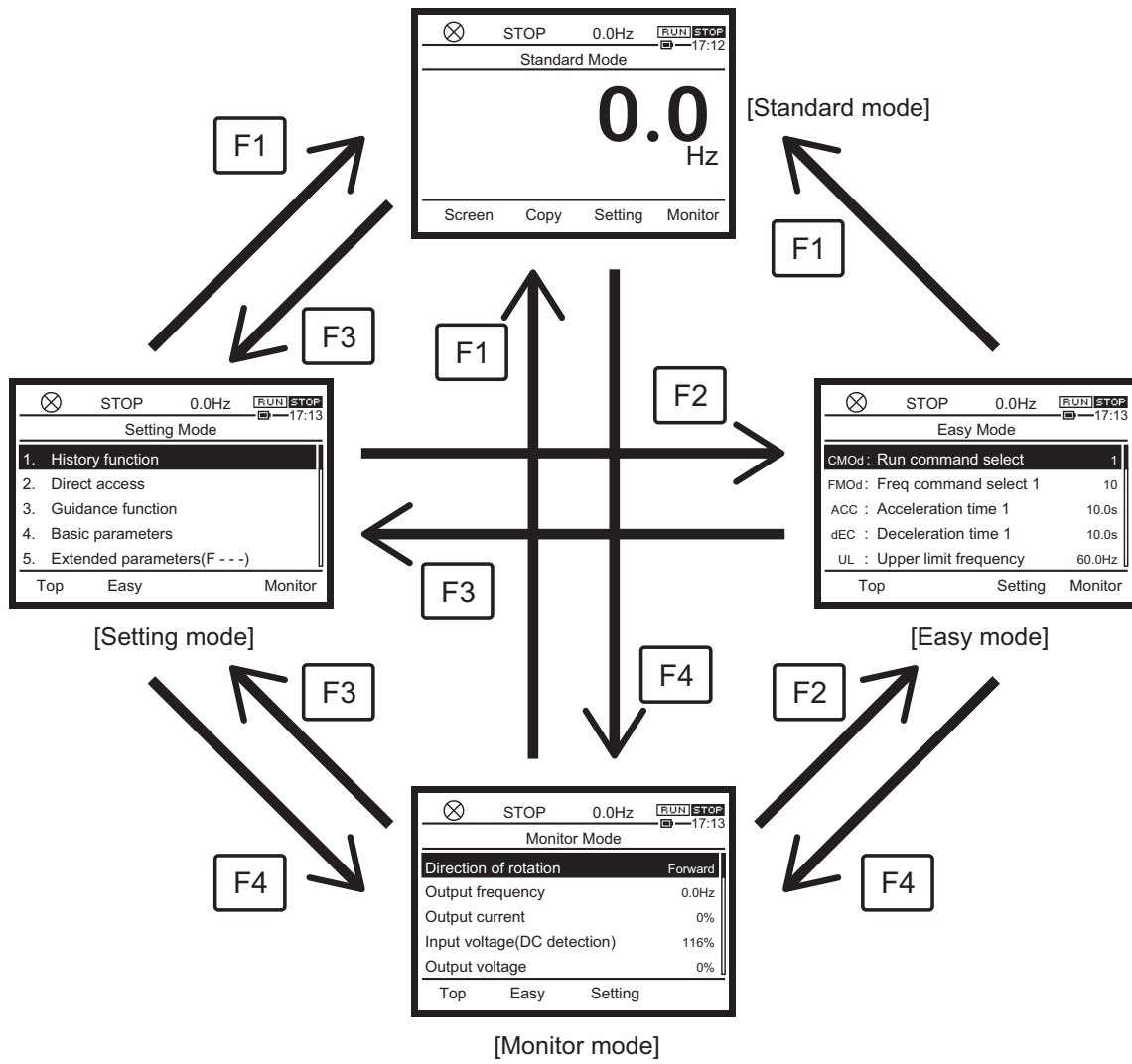

8

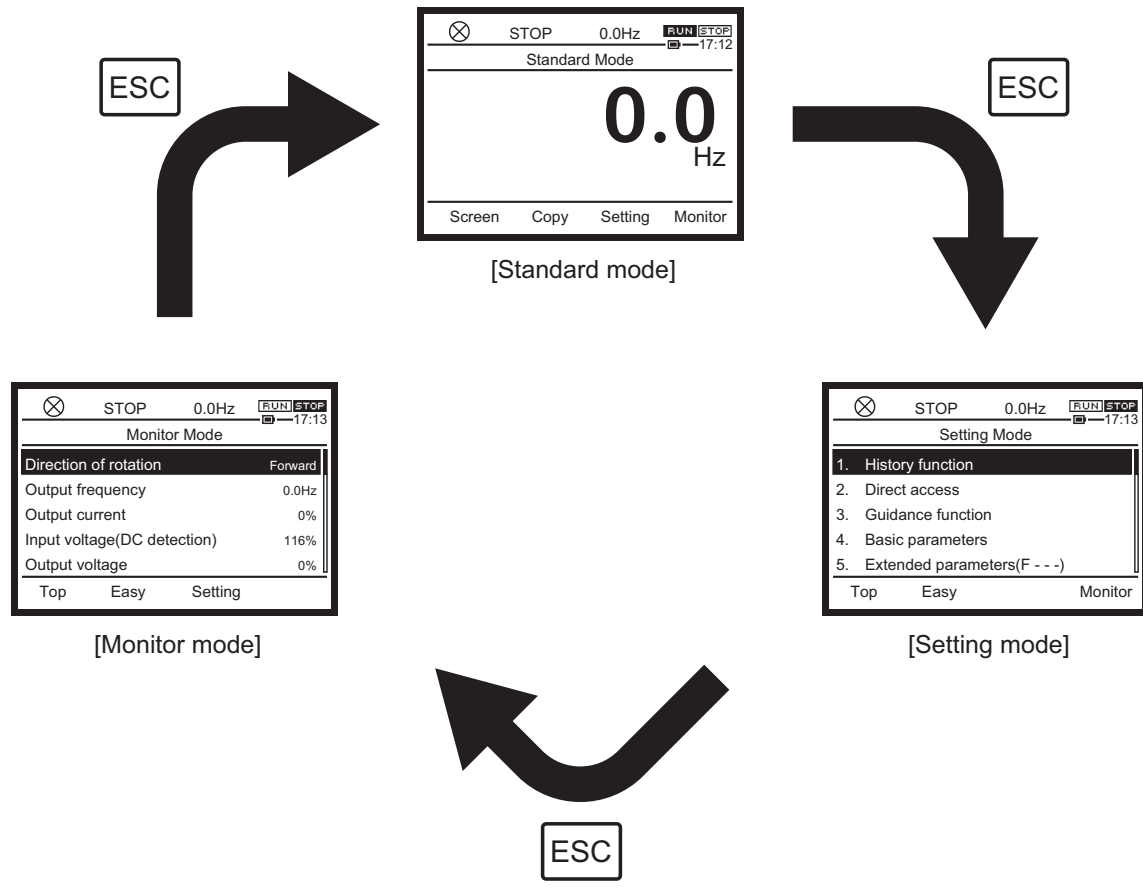

■ **Screen configuration of [Monitor mode]**

If an "OK" mark is displayed on the [F4] key when you select any of the displayed items, a details monitor is available. When you press the [F4] key or [OK] key, you can go to the details monitor. When you press the [i] key, you can check the inverter rating and the CPU version.

1) **Direction of rotation**

"Forward" or "Reverse" is displayed.

The direction of rotation of the monitor output by the inverter is displayed whether the motor is run or stopped.

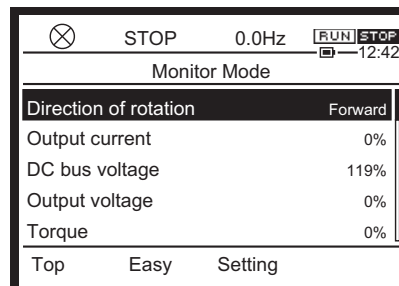

2) **Selected monitor 1 to 8**

The monitor items selected with <F711: Monitor mode 1 display> to <F718: Monitor mode 8 display> are displayed. In the default setting, the following monitor items are displayed.

- Output current
- Input voltage (DC detection)
- Output voltage
- Torque
- Input power
- Output power
- Inverter load factor
- Motor load factor

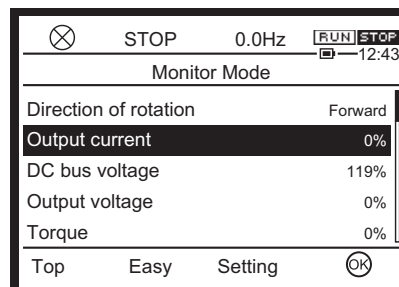

**Memo**

- Output current: The current monitored is displayed in percentage. The value indicated on the nameplate is 100%. The unit can be switched to A (amperes). Set <F701: Current, voltage units select> to "1: A (ampere), V (volt)."
- Input voltage: The reference values (100% values) are 200 V (240 V class) and 400 V (480 V class). The voltage displayed is the voltage determined by converting the voltage measured in the DC section into an AC voltage. The unit can be switched to V (volts). Set <F701: Current, voltage units select> to "1: A (ampere), V (volt)."
- Output voltage: The reference values (100% values) are 200 V (240 V class) and 400 V (480 V class). The voltage displayed is the output command voltage. The unit can be switched to V (volts). Set <F701: Current, voltage units select> to "1: A (ampere), V (volt)."
- Load factor of inverter: Depending on <F300: Carrier frequency> setting and so on, the actual rated current may become smaller than the rated output current indicated on the nameplate. With the actual rated current at that time (after reduction) as 100%, the proportion of the load current to the rated current is indicated in percent. The load factor is also used to calculate the conditions for overload trip "OL1".

In the details monitor, it is indicated with a graphic bar.

When you press the [F2] key ("Change"), you can go to <F711: Monitor mode 1 display> to <F718: Monitor mode 8 display> to change settings.

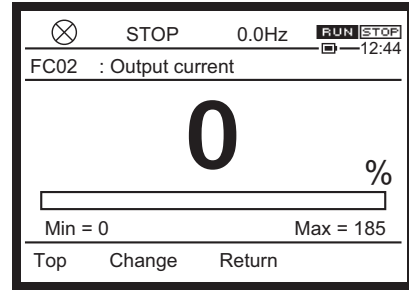

Title	Parameter name	Adjustment range	Default setting
F711	Monitor mode 1 display	0 - 162*1	2
F712	Monitor mode 2 display	0 - 162*1	3
F713	Monitor mode 3 display	0 - 162*1	4
F714	Monitor mode 4 display	0 - 162*1	8
F715	Monitor mode 5 display	0 - 162*1	18
F716	Monitor mode 6 display	0 - 162*1	19
F717	Monitor mode 7 display	0 - 162*1	35
F718	Monitor mode 8 display	0 - 162*1	34

\*1 For details, refer to the table at the end of this subsection.

### 3) Input/output terminals

The details monitor displays the ON/OFF status of the following input/output terminals.

- Input terminal 1 (F, R, RES, S1...S4, S5)
- Input terminal 2 (DI11, DI12...DI16)
- Output terminal 1 (FP, FL,R1, R2)
- Output terminal 2 (DQ11, DQ12, R3, R4, R5)
- Output terminal 3 (R6, R7...R11)

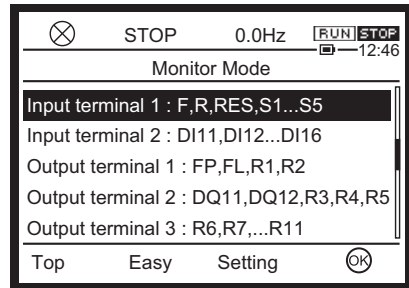

If the terminal you have selected has a related parameter, the [F2] key ("Change") is displayed. When you press the [F2] key ("Change"), you can go to the screen of the related parameter to change the setting.

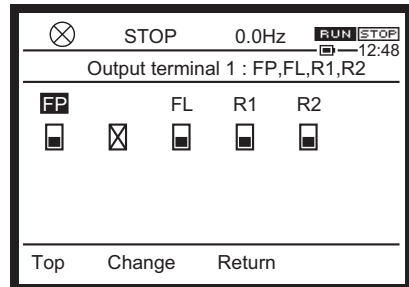

4) Past trip 1 to 8

The trip records are displayed. Past trip 1 is the record of the latest trip, and Past trip 8 is the record of the oldest trip.

If no trip information exists, "nErr" is displayed.

On the details monitor, you can check the details of trips. Refer to [8.1.2].

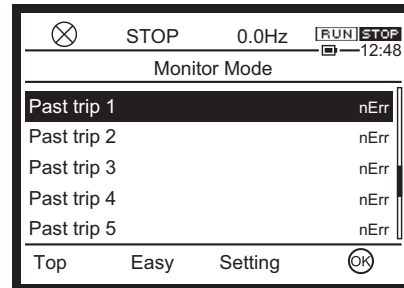

5) Communication status

The details monitor displays the transmitting/receiving status of RS485 communication connector 1, 2.

The connector 1 signal transmitting "TX1", connector 1 signal receiving "RX1", connector 2 signal transmitting "TX2", and connector 2 signal receiving "RX2" are displayed.

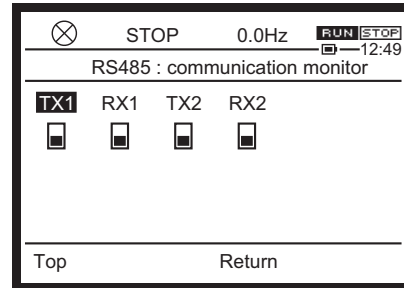

6) Parts replacement alarm information

The details monitor displays replacement alarms of the cooling fan, capacitor, etc.

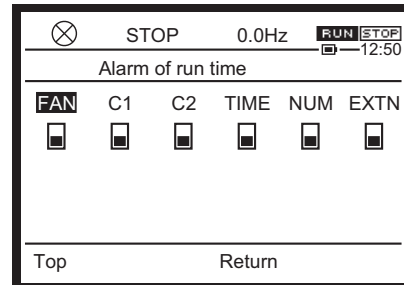

7) Cumulative run time

The cumulative run time of the inverter is displayed. The display unit is 100 hours, and the minimum value 0.01 is equal to 1 hour.

To clear the value, set <tyP: Default setting> to "5: Clear cumulative run time."

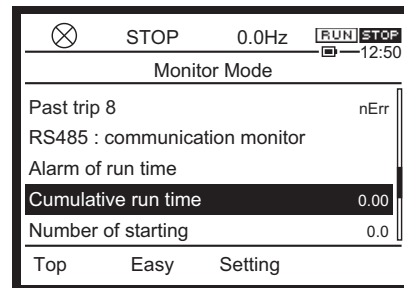

8) Number of starting

The number of starting of the inverter is displayed. The display unit is one time, and the maximum value is 9.99 million times.

(In the case of an LED display extension panel, the display unit is 10000 times, and the minimum value 0.1 is equal to 1000 times.)

To clear the value, set <tyP: Default setting> to "12: Clear cumulative run time."

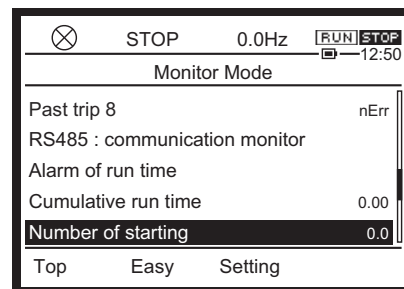



■ Settings for <F711: Monitor mode 1 display> to <F718: Monitor mode 8 display>

Setting value	Function name	Display unit	Setting value	Function name	Display unit
0	Output frequency	0.1 Hz	71	Motor speed (estimated value, Max. 32700 min <sup>-1</sup> )	min <sup>-1</sup>
1	Frequency command value	0.1 Hz	72	Communication option Receiving counter	1
2	Output current	1%/<F701> setting *1	73	Communication option Abnormal counter	1
3	Input voltage (DC detection)	1%/<F701> setting *1	76	Terminal S4/S5 pulse train input value	0.10%
4	Output voltage	1%/<F701> setting *1	77	My function COUNT1	1
5	Stator frequency	0.1 Hz	78	My function COUNT2	1
6	Speed feedback frequency (real time)	0.1 Hz	79	Dancer control PID result frequency	0.1 Hz
7	Speed feedback frequency (1-second filter)	0.1 Hz	80	Embedded Ethernet Transmission counter	1
8	Torque	1% *1	81	Embedded Ethernet Receiving counter	1
9	Torque command	1% *1	82	Embedded Ethernet Abnormal counter	1
10	Output frequency during run.	Hz/free unit	83	Connected option number	1
	Frequency command value during stop.		84	My function COUNT3	1
11	Torque current	1% *1	85	My function COUNT4	1
12	Exciting current	1%	86	My function COUNT5	1
13	PID feedback value	0.1 Hz	90	Cumulative power ON time	100 hours
14	Motor overload factor (OL2 data)	1%	91	Cumulative cooling fan run time	100 hours
15	Inverter overload factor (OL1 data)	1%	92	Cumulative run time	100 hours
16	Braking resistor overload factor (OLr data)	1%	93	Cumulative overcurrent time	100 hours
17	Braking resistor load factor (%ED)	1%	95	Pump 0 run time	100 hours
18	Input power	0.1 kW *1	96	Pump 1 run time	100 hours
19	Output power	0.1 kW *1	97	Pump 2 run time	100 hours
20	Input cumulative power	<F749> setting	98	Pump 3 run time	100 hours
21	Output cumulative power	<F749> setting	99	Pump 4 run time	100 hours

Setting value	Function name	Display unit	Setting value	Function name	Display unit
22	-	-	100	Number of starting	10000 times
23	-	-	101	Number of Fwd starting	10000 times
24	Terminal RR input value	1%	102	Number of Rev starting	10000 times
25	Terminal RX input value	1%	103	External equipment counter	Time
26	Terminal II input value	1%	105	Pump 5 run time	100 hours
27	Motor speed command (max 32700 min <sup>-1</sup> )	min <sup>-1</sup>	106	Pump 6 run time	100 hours
28	Terminal FM output value	1	107	Pump 7 run time	100 hours
29	Terminal AM output value	1	108	Pump 8 run time	100 hours
30	-	-	109	Pump 9 run time	100 hours
31	Communication data output	*2	110	Number of trip	Time
32	Slot A option CPU version	-	111	Number of serious failure trip	1
33	Slot B option CPU version	-	112	Number of slight failure trip	1
34	Motor load factor	%	113	Number of specified trip 1	1
35	Inverter load factor	%	114	Number of specified trip 2	1
36	Inverter rated current	A	115	Number of specified trip 3	1
37	Inverter rated current (with carrier frequency correction )	A	120	Internal temperature 1	°C
38	Actual carrier frequency	kHz	124	Main circuit board temperature	°C
39	Slot C option CPU version	-	130	External PID3 set value	0.1 Hz
40	Embedded Ethernet CPU version	-	131	External PID3 feedback value	0.1 Hz
41	Terminal FP pulse train output value	pps	132	External PID3 result value	0.1 Hz
43	Terminal FM/AM gain setting value	-	133	External PID4 set value	0.1 Hz
44	Terminal AI4 input value	1%	134	External PID4 feedback value	0.1 Hz
45	Terminal AI5 input value	1%	135	External PID4 result value	0.1 Hz
46	My function monitor output 1	-	150	Signed output frequency	0.1 Hz
47	My function monitor output 2	-	151	Signed frequency command value	0.1 Hz
48	My function monitor output 3	-	152	Signed stator frequency	0.1 Hz
49	My function monitor output 4	-	153	Signed speed feedback frequency (real time)	0.1 Hz

Setting value	Function name	Display unit	Setting value	Function name	Display unit
62	PID result frequency	0.1 Hz	154	Signed speed feedback frequency (1-second filter)	0.1 Hz
63	PID set value	0.1 Hz	155	Signed torque	1%
64	Light-load high-speed switching load torque	1%	156	Signed torque command	1%
65	Light-load high-speed torque during constant speed run	1%	158	Signed torque current	1%
66	Pattern operation group number	0.1	159	Signed PID feedback value	0.1 Hz
67	Pattern operation remaining cycle number	1	160	Signed terminal RX input value	1%
68	Pattern operation preset speed number	1	161	Signed terminal AI4 input value	1%
69	Pattern operation remaining time	0.1	162	Signed terminal AI5 input value	1%
70	Inverter rated voltage	1 V			

\*1 Filtered value.

Filter time constant can be set by <F722>.

\*2 For details, refer to "RS485 Communication Function Instruction Manual" (E6582143).

## 8. 1. 2 Detailed display of past trip

When you press the [OK] key while Past trip 1 to 8 are displayed in [Monitor mode], more detailed information can be displayed as follows.

Unlike "Display at the time of trip" in [3. 2. 2], it can be displayed after the inverter is turned off or reset. However, the monitor value of a trip is not always recorded as the maximum value because of the time required for detection.

### ■Details of the past

On the detail screen of the past trip show the information of the 13 items.

The trip history number and trip name are displayed in the mode name area.

- Number of occurrences
- Output frequency
- Direction of rotation
- Frequency command value
- Output current
- Input voltage (DC detection)
- Output voltage
- Input terminal 1 (F, R, RES, S1...S4, S5)
- Output terminal 1 (FP, FL,R1, R2)
- Cumulative operation time
- Year
- Month, Date
- Hour, Minutes

⊗	STOP	10.0Hz	[RUN] [STOP]
Past trip 1		Cooling FAN fault	
Output terminal 1 : FP,FL,R1,R2			
Cumulative run time			0.00
Year			2015
Month . Day			7.13
Hour . Minute			13.06
Top		Return	

8

At following circumstance, the trip date (year, month, ...) are not correct.

1. LCD keypad is not attached.
2. date (year, month, ...) are not set correctly.
3. the battery of LCD keypad is empty.

## 8.2 Screen display at trip occurrence

If an alarm occurs, text is displayed on the LCD screen according to the contents of the alarm.

If a trip occurs, text is displayed on the LCD screen, and the backlight turns red to indicate an error.

### 8.2.1 Display of trip information and alarm information

If the inverter trips, the contents of the trip are displayed. You can also check the status at the time of trip in [Monitor mode].

If the inverter issues an alarm, the contents of the alarm are displayed.

Refer to "Chap 13" for trip and alarm display.

### 8.2.2 Monitor display at trip

Data at the time of occurrence of the trip are retained.

Before the inverter is turned off or reset, information equivalent to "Operation Status monitor" in [8. 1. 1] can be displayed in [Monitor mode].

After power off or reset, information is stored in Past trip 1 to 8 in [Monitor mode]. For details, refer to [8. 1. 2].



# 9

## Measures to satisfy standards

I

II

This chapter explains the measures to comply with the EMC Directive, UL/CSA Standards, etc. by introducing examples.

1

2

3

4

5

6

7

8

9

10

11

12

13

14

15

16

### 9.1 How to deal with CE marking

CE mark is put on all products of VF-AS3 to declare that they are in conformity with the requirements of Low Voltage Directive and EMC Directive, also the products integrating the safety function are in conformity with the requirements of machine directive as safety component.

The CE mark must be put on all machines and systems with built-in inverters because such machines and systems are subject to the above directives. If they are final products, they might also be subject to the Machinery Directive.

It is the responsibility of the manufacturers of such final products to put the CE mark on each final product. In order to make machines and systems with built-in inverters comply with the EMC Directive and the Low Voltage Directive, we recommend the installation method of inverters and measures for EMC Directive described in this instruction manual.

We have tested representative models with them installed under the environment described later in this manual to check for conformity with the EMC Directive. However, we cannot check the inverters under your operating environment. EMC varies depending on the composition of the control panel with a built-in inverter(s), the relationship with other built-in electrical components, the wiring condition, the layout condition, and so on. Therefore, you need to verify yourself whether your machine and system conforms to the EMC Directive.

#### 9.1.1 Compliance with EMC Directive

The CE mark must be put on every final product that includes an inverter(s) and a motor(s). 480V class inverters of VF-AS3 series are equipped with an EMC filter and comply with the EMC Directive if wiring is carried out correctly.

The EMC standards are broadly divided into two categories; Emission and Immunity, each of which is further categorized according to the operating environment of each individual machine as shown in the table below. We consider that the tests required for machines and systems as final products are almost the same as those required for inverters.

Category	Subcategory	Product standards	Test standard
Emission	Radiated noise	IEC61800-3	CISPR11 (EN55011)
	Conducted noise		CISPR11 (EN55011)
Immunity	Electrostatic discharge		IEC61000-4-2
	Radio-frequency electromagnetic field		IEC61000-4-3
	Electrical fast transient/burst		IEC61000-4-4
	Surge		IEC61000-4-5
	Conducted radio-frequency common mode		IEC61000-4-6
	Voltage dips, short interruptions and voltage variations	IEC61000-4-11	

**(1) EMC Directive compliance of this inverter**

The built-in EMC filter on the input side of this inverter (480 V class) reduces conducted noise and radiated noise from input cables. The compliance with the EMC Directive is as shown in the table below.

Inverter type	Carrier frequency <F300>	Conducted noise IEC61800-3 category C2 (EN55011 classB Group1)	Conducted noise IEC61800-3 category C3 (EN55011 classB Group1)
		Length of motor connecting cable	Length of motor connecting cable
	(kHz)	(m)	(m)
VFAS3-4004PC	4	50	150
VFAS3-4007PC	4	50	150
VFAS3-4015PC	4	50	150
VFAS3-4022PC	4	50	150
VFAS3-4037PC	4	50	150
VFAS3-4055PC	4	50	150
VFAS3-4075PC	4	50	150
VFAS3-4110PC	4	50	150
VFAS3-4150PC	4	50	150
VFAS3-4185PC	4	50	150
VFAS3-4220PC	4	50	150
VFAS3-4300PC	4	50	150
VFAS3-4370PC	4	50	150
VFAS3-4450PC	2.5	-	150
VFAS3-4550PC	2.5	-	150
VFAS3-4750PC	2.5	-	150
VFAS3-4900PC	2.5	-	150



Inverter type	Carrier frequency <F300>	Conducted noise IEC61800-3 category C2 (EN55011 classB Group1)	Conducted noise IEC61800-3 category C3 (EN55011 classB Group1)
		Length of motor connecting cable	Length of motor connecting cable
	(kHz)	(m)	(m)
VFAS3-4110KPC	2.5	-	150
VFAS3-4132KPC	2.5	-	150
VFAS3-4160KPC	2.5	-	50
VFAS3-4200KPC	2.5	-	50
VFAS3-4220KPC	2.5	-	50
VFAS3-4280KPC	2.5	-	50

**(2) Examples of measures to comply with EMC Directive**

The following are measures to comply with the EMC Directive when you use 480V class products of VF-AS3 by installing it in other machines and systems.

- Examples of general measures
- When adding an EMC filter for further reduction of noise
- Measures for operation with external signals

The following are general EMC measures explained concretely.

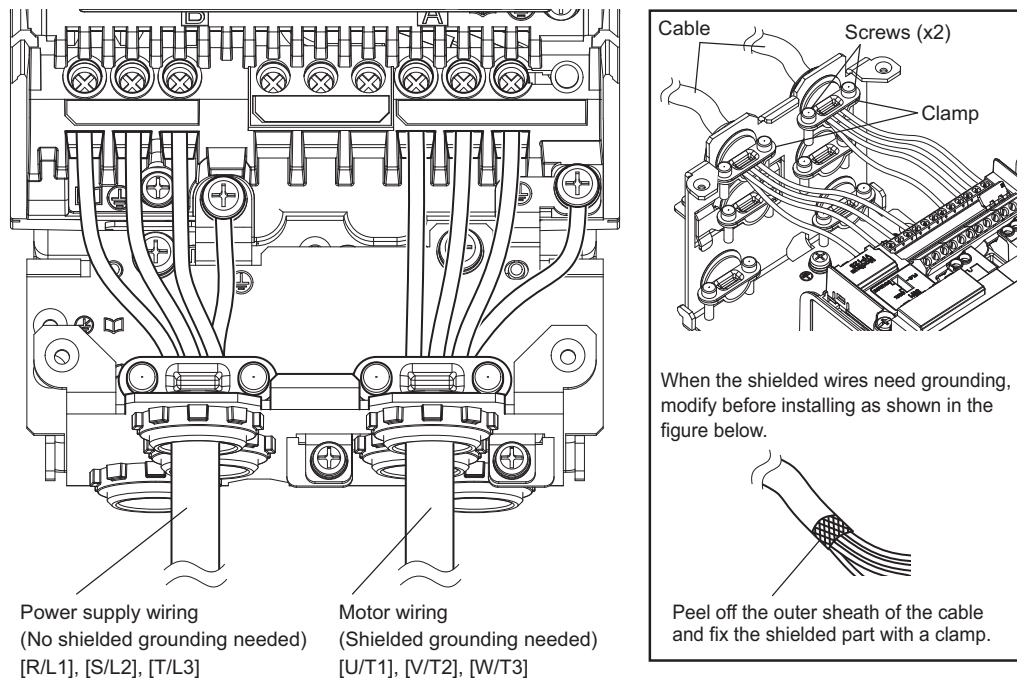

**Using shielded power wires and shielded control wires**

- Use shielded power wires, such as inverter input/output wires, and shielded control wires.
- Route the wires and wires so as to minimize their lengths.
- Keep a distance between the power cable and the control wire and between the input and output wires of the power cable. Do not route them in parallel or bind them together. Instead, if necessary, cross at right angle.

**Installing inverter in steel cabinet**

- Install the inverter in a sealed steel cabinet.
- Using wires as thick and short as possible, ground the metal plate and the control panel securely with a distance kept between the grounding wire and the power wire.

**Routing input and output wires apart**

- Route the input and output wires apart as far as possible from each other.

**Grounding of shielded wires**

- To ground shielded wires through a metal conduit.
- To ground the shielded control wires by fixing the metal saddle of the body.
- Inserting a ferrite core in a shielded wire is even more effective in limiting the radiated noise.

**Inserting zero-phase reactor and ferrite cores**

- Insert a zero-phase reactor in the inverter output line.
- Insert ferrite cores in the grounding wires of the metal plate and cabinet.

**(3) Measures for operation with external signals**

To operate with external signals, take measures as shown in the figure below (e.g.: using a potentiometer and Fwd/Rev terminals).

9

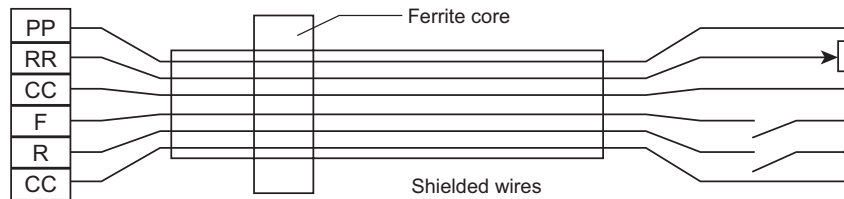

**9. 1. 2 Compliance with Low Voltage Directive**

The Low Voltage Directive provides for the safety of machines and systems.

**(1) Low Voltage Directive Compliance of this inverter**

Inverters are CE-marked in accordance with the requirement of Low Voltage Directive, and can therefore be installed in machines or systems and exported without problem to European countries.

- Applicable standard: IEC61800-5-1
- Pollution degree: 2
- Overvoltage category: 3

## (2) Example of measures to comply with Low Voltage Directive

When incorporating the inverter into a machine and system, it is necessary to take the following measures so that the inverter satisfies the Low Voltage Directive.

### Installing in cabinet

- Install the inverter in a cabinet and ground the inverter enclosure.
- When doing maintenance, be extremely careful not to put your fingers into the inverter through a wiring hole and touch a charged part, which may occur depending on the model of the inverter used.

### Paying attention to how to ground

- To ground shielded wires through a metal conduit.
- Connect grounding wires other than the shielded wires to the grounding terminals on the inverter.
- However, do not connect two or more grounding wires to the grounding terminals (screws) for the inverter main circuit.
- Refer to the table in [10. 1] to select a grounding wire size.

### Installing protection device

- Install a fuse, an earth leakage circuit breaker (ELCB) or a molded-case circuit breaker (MCCB) on the input side of the inverter. For details, refer to [9. 2. 3] [10. 2. 2].

## 9.2 Compliance with UL/CSA Standards

The VF-AS3 models, that conform to the UL Standard and CSA Standard have the UL/CSA mark on the nameplate.

### 9.2.1 Compliance with Installation

The VF-AS3 inverter must be mounted on a wall, and used within the ambient temperature specification.

For frame size A6, A7 and A8, a UL certificate was granted on the assumption that the inverter would be installed in a cabinet. Therefore, install the inverter in a cabinet and if necessary, take measures to maintain the ambient temperature (temperature in the cabinet) within the specified temperature range.

Maximum Surrounding Air Temperature is 50°C.	
240V	0.4 - 55kW (HD), 0.75 - 75kW (ND)
480V	0.4 - 280kW (HD), 0.75 - 160kW (ND)

Maximum Surrounding Air Temperature is 45°C.	
220 - 315kW (ND)	

\* Refer to [1. 2] for (HD) and (ND).

### 9.2.2 Compliance with Connection

Use the UL conformed cables (Rating 75°C or more, Use the copper conductors only.) to the main circuit terminals (R/L1, S/L2, T/L3, U/T1, V/T2, W/T3), UL-certified electric wire for FLA, FLB, FLC, R1A, R1C, R2A and R2C terminals.

For instruction in the United States, Integral solid state short circuit protection does not provide branch circuit protection. Branch circuit protection must be provided in accordance with the National Electrical Code and any additional local codes.

For instruction in the Canada, Integral solid state short circuit protection does not provide branch circuit protection. Branch circuit protection must be provided in accordance with the Canadian Electrical Code and any additional local codes.

=> For recommended tightening torque, see [2. 3. 3]

=> For recommended electric wire sizes, see [9. 2. 3]

=> Use the electric wire of Class1 for the control circuits.

For details of wiring, terminals and the functions, refer to [2. 3. 2], [2. 3. 3], [2. 3. 4], [2. 3. 5].

### 9.2.3 Cautions for peripheral devices

Install a UL conformed fuse on the input side of the inverter.

For this inverter, a UL test has been conducted under the interrupting current (current that runs when interruption of power occurs) conditions in the table below. Note that the interrupting current varies depending on the applicable motor output.

Max input voltage (V)	Applicable motor output (kW @ND)	Power supply short-circuit current (A)
3-phase 240 V	0.7 - 37	Suitable For Use On A Circuit Capable Of Delivering Not More Than 5,000A rms Symmetrical Amperes, 240 Volts Maximum When Protected by J Class Fuses
	45	Suitable For Use On A Circuit Capable Of Delivering Not More Than 10,000A rms Symmetrical Amperes, 240 Volts Maximum When Protected by J Class Fuses
	55 - 75	Suitable For Use On A Circuit Capable Of Delivering Not More Than 10,000A rms Symmetrical Amperes, 240 Volts Maximum When Protected by AR Class Fuses
3-phase 480 V	0.7 - 37	Suitable For Use On A Circuit Capable Of Delivering Not More Than 5,000A rms Symmetrical Amperes, 480 Volts Maximum When Protected by J Class Fuses
	45 - 90	Suitable For Use On A Circuit Capable Of Delivering Not More Than 10,000A rms Symmetrical Amperes, 480 Volts Maximum When Protected by J Class Fuses
	110 - 132	Suitable For Use On A Circuit Capable Of Delivering Not More Than 10,000A rms Symmetrical Amperes, 480 Volts Maximum When Protected by AR Class Fuses
	160	Suitable For Use On A Circuit Capable Of Delivering Not More Than 18,000A rms Symmetrical Amperes, 480 Volts Maximum When Protected by AR Class Fuses
	220	Suitable For Use On A Circuit Capable Of Delivering Not More Than 18,000A rms Symmetrical Amperes, 480 Volts Maximum When Protected by J Class Fuses
	250 - 280	Suitable For Use On A Circuit Capable Of Delivering Not More Than 18,000A rms Symmetrical Amperes, 480 Volts Maximum When Protected by T Class Fuses
	315	Suitable For Use On A Circuit Capable Of Delivering Not More Than 30,000A rms Symmetrical Amperes, 480 Volts Maximum When Protected by T Class Fuses

For the classes, current values, and the wire sizes of fuses, refer to the following table.

**9**

Voltage class	Applicable motor [kW]	Inverter type	Output current *1	AIC (A) (Interrupting capacity)	Fuse class and current (A)	Power wire sizes *2	Grounding wire sizes *2
3-phase 240 V	0.75	VFAS3-2004P	4.6 <F300>="4"	AIC 5000A	J 6Amax.	AWG 14	AWG 14
	1.5	VFAS3-2007P	8.0 <F300>="4"	AIC 5000A	J 10Amax.	AWG 14	AWG 14
	2.2	VFAS3-2015P	11.2 <F300>="4"	AIC 5000A	J 15Amax.	AWG 14	AWG 14
	4.0	VFAS3-2022P	18.7 <F300>="4"	AIC 5000A	J 25A max.	AWG 10	AWG 12
	5.5	VFAS3-2037P	25.4 <F300>="4"	AIC 5000A	J 35Amax.	AWG 8	AWG 10
	7.5	VFAS3-2055P	32.7 <F300>="4"	AIC 5000A	J 45Amax.	AWG 8	AWG 10
	11	VFAS3-2075P	46.8 <F300>="4"	AIC 5000A	J 60Amax.	AWG 6	AWG 10
	15	VFAS3-2110P	63.4 <F300>="4"	AIC 5000A	J 90Amax.	AWG 4	AWG 10
	18.5	VFAS3-2150P	78.4 <F300>="4"	AIC 5000A	J 110Amax.	AWG 2	AWG 8
	22	VFAS3-2185P	92.6 <F300>="4"	AIC 5000A	J 125Amax.	AWG 1	AWG 8
	30	VFAS3-2220P	123.0 <F300>="2.5"	AIC 5000A	J 150Amax.	AWG 2/0	AWG 6
	37	VFAS3-2300P	149.0 <F300>="2.5"	AIC 5000A	J 175Amax.	AWG 3/0	AWG 6
	45	VFAS3-2370P	176.0 <F300>="2.5"	AIC 10000A	J 225Amax.	250MCM	AWG 6
	55	VFAS3-2450P	211.0 <F300>="2.5"	AIC 10000A	AR 315Amax.	AWG 2/0 × 2 *3 *4	AWG 6 *3 *4
	75	VFAS3-2550P	282.0 <F300>="2.5"	AIC 10000A	AR 350Amax.	AWG 3/0 × 2 *3 *4	AWG 4 *3 *4
3-phase 480 V	0.75	VFAS3-4004PC	2.2 <F300>="4"	AIC 5000A	J 3Amax.	AWG 14	AWG 14
	1.5	VFAS3-4007PC	4.0 <F300>="4"	AIC 5000A	J 6Amax.	AWG 14	AWG 14
	2.2	VFAS3-4015PC	5.6 <F300>="4"	AIC 5000A	J 10Amax.	AWG 14	AWG 14
	4.0	VFAS3-4022PC	9.3 <F300>="4"	AIC 5000A	J 15Amax.	AWG 14	AWG 14
	5.5	VFAS3-4037PC	12.7 <F300>="4"	AIC 5000A	J 15Amax.	AWG 12	AWG 14
	7.5	VFAS3-4055PC	16.5 <F300>="4"	AIC 5000A	J 20Amax.	AWG 10	AWG 14

Voltage class	Applicable motor [kW]	Inverter type	Output current *1	AIC (A) (Interrupting capacity)	Fuse class and current (A)	Power wire sizes *2	Grounding wire sizes *2
3-phase 480 V	11	VFAS3-4075PC	23.5 <F300>="4"	AIC 5000A	J 30Amax.	AWG 10	AWG 10
	15	VFAS3-4110PC	31.7 <F300>="4"	AIC 5000A	J 40Amax.	AWG 8	AWG 10
	18.5	VFAS3-4150PC	39.2 <F300>="4"	AIC 5000A	J 50Amax.	AWG 8	AWG 10
	22	VFAS3-4185PC	46.3 <F300>="4"	AIC 5000A	J 60Amax.	AWG 6	AWG 10
	30	VFAS3-4220PC	61.5 <F300>="4"	AIC 5000A	J 80Amax.	AWG 4	AWG 10
	37	VFAS3-4300PC	74.5 <F300>="4"	AIC 5000A	J 100Amax.	AWG 3	AWG 8
	45	VFAS3-4370PC	88.0 <F300>="4"	AIC 10000A	J 110Amax.	AWG 1	AWG 8
	55	VFAS3-4450PC	106.0 <F300>="2.5"	AIC 10000A	J 150Amax.	AWG 1/0	AWG 6
	75	VFAS3-4550PC	145.0 <F300>="2.5"	AIC 10000A	J 200Amax.	AWG 3/0	AWG 6
	90	VFAS3-4750PC	173.0 <F300>="2.5"	AIC 10000A	J 225Amax.	250MCM	AWG 6
	110	VFAS3-4900PC	211.0 <F300>="2.5"	AIC 10000A	AR 250Amax.	AWG 1/0 × 2 *3 *4	AWG 4 *3 *4
	132	VFAS3-4110KPC	250.0 <F300>="2.5"	AIC 10000A	AR 315Amax.	AWG 2/0 × 2 *3 *4	AWG 4 *3 *4
	160	VFAS3-4132KPC	302.0 <F300>="2.5"	AIC 18000A	AR 350Amax.	AWG 4/0 × 2 *3 *4	AWG 4 *3 *4
	220	VFAS3-4160KPC	427.0 <F300>="2.5"	AIC 18000A	J 500Amax.	350MCM × 2	AWG 2/0
	250	VFAS3-4200KPC	481.0 <F300>="2.5"	AIC 18000A	J 600Amax.	250MCM × 3	AWG 2/0
	280	VFAS3-4220KPC	550.0 <F300>="2.5"	AIC 18000A	J 600Amax.	300MCM × 3	AWG 3/0
	315	VFAS3-4280KPC	616.0 <F300>="2.5"	AIC 30000A	T 800Amax.	350MCM × 3	AWG 3/0

\*1 The UL rated output current is the one when the carrier frequency <F300> is the value in the table or less.

\*2 The wire size is the one when 75°C is continuously allowed (ambient temperature of 40°C or less).

\*3 This part shows the wiring size with using the Lug terminal.

\*4 Lug terminal for Frame size A6 has some constraints. Refer to page 9-10.

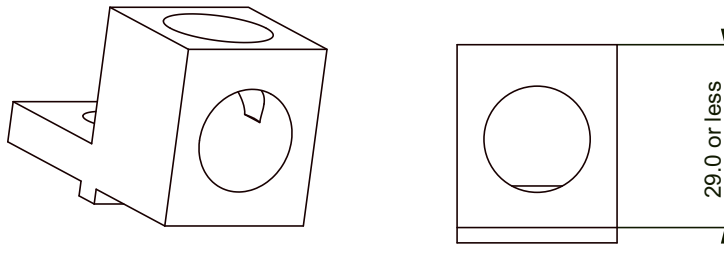
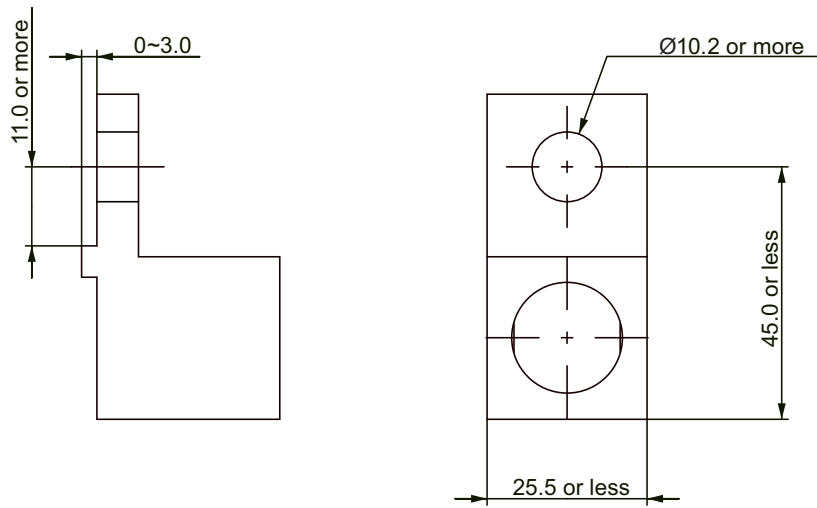

**9**

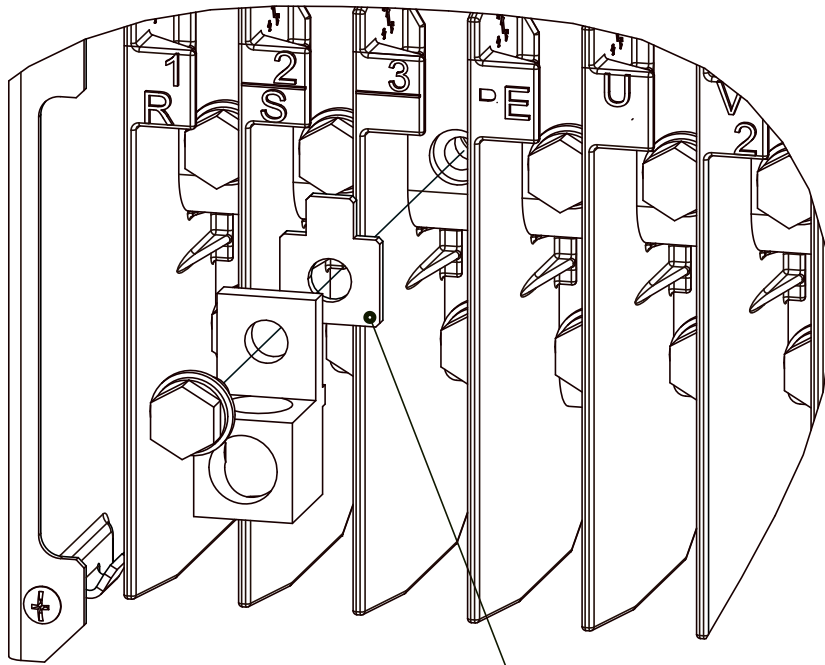

Put a sheetmetal accessory when Lug terminal has "Turn prevent" shape



- The input withstand rating is obtained with heat calculation. If the fuse is installed to a circuit with larger input withstand rating, a reactor should be installed so that the input withstand rating should be reduced below this level.
- Output interrupt rating varies depending on the type of integral solid state short circuit. Install the fuse according to the NEC standard, local standard and type of installation.
- Use a fuse of Cooper Bussmann or Mersen.
- Be sure to use rod crimp-style terminals for the grounding terminals of the heat sink and metal plate of the inverter.

### **9. 2. 4**     **Overload protection**

The overload protection levels are below,

HD rating: 150%-1minute, 180%-2s (Frame size A1~A6)

150%-1minute, 165%-2s (Frame size A7, A8)

ND rating: 120%-1minute, 135%-2s (All frame sizes)

For the rated current, refer to the name plate.

### **9. 2. 5**     **Motor thermal protection**

To use the electronic thermal function of this inverter for motor thermal protection, set parameters according to the motor specifications applied. For details, refer to [5. 2. 5].

When operating multiple motors with one inverter, install overload relay for each motor.

### **9. 2. 6**     **Motor integrated PTC thermal protection**

For details, refer to [6. 30. 19].

### **9. 2. 7**     **Other**

Contact your Toshiba distributor or Toshiba sales representative (see the back cover of this manual), if you need the hard copy (paper) of CD-ROM.

## **9. 3**     **Compliance with safety standards**

For details, refer to "VF-AS3 Safety function manual" (E6582068).



# 10 Selection and installation of peripheral devices

I

II

In this chapter, the selection and installation methods of peripheral devices for this inverter are described.

1

2

3

4

5

6

7

8

9

10

11

12

13

14

15

16

## WARNING



Mandatory action

- All options to be used must be those specified by Toshiba. The use of options other than those specified by Toshiba will result in an accident.
- In using a power distribution device and options for the inverter, they must be installed in a cabinet. When they are not installed in the cabinet, this will result in electric shock.



Be sure to connect the grounding wire.

- The grounding wire must be connected securely. If the grounding wire is not securely connected, when the inverter has failure or earth leakage, this will result in electric shock or fire.

## 10.1 Selection of wire size

According to the voltage class and capacity of the inverter, perform wiring using appropriate wires as shown in the table below. When connecting peripheral devices to the inverter also, perform wiring according to the wire size for a wire location shown in the table below.

- The wire size is a value when using a 600 V HIV insulation wire (copper wire with the maximum allowable temperature 75 °C of an insulator) with 50 °C ambient temperature and 30 m or less the length of each wire.
- For the wire of the control circuit, use a shielded wire with 0.75 mm<sup>2</sup> or more.

## ■Wire size for HD rating

Voltage class	Applicable motor (kW)	Inverter type-form		Wire size (mm <sup>2</sup> )				
				Power circuit		DC wire	Braking resistor (Optional)	Grounding wire
				Input	Output			
3-phase 240 V	0.4	VFAS3-	2004P	1.5	1.5	2.5	1.5	2.5
	0.75		2007P	1.5	1.5	2.5	1.5	2.5
	1.5		2015P	1.5	1.5	2.5	1.5	2.5
	2.2		2022P	1.5	1.5	2.5	1.5	2.5
	4.0		2037P	2.5	4	2.5	1.5	4
	5.5		2055P	4	6	4	1.5	6
	7.5		2075P	6	10	6	2.5	10
	11		2110P	10	16	10	4	16
	15		2150P	16	25	16	6	16
	18.5		2185P	25	35	25	10	16
	22		2220P	35	50	35	16	25
	30		2300P	50	70	50	25	35
	37		2370P	70	95	70	35	50
	45		2450P	95	120	95	50	70
	55		2550P	120	70x2	120	50	95
3-phase 480 V	0.4	VFAS3-	4004PC	1.5	1.5	2.5	1.5	2.5
	0.75		4007PC	1.5	1.5	2.5	1.5	2.5
	1.5		4015PC	1.5	1.5	2.5	1.5	2.5
	2.2		4022PC	1.5	1.5	2.5	1.5	2.5
	4.0		4037PC	1.5	1.5	2.5	1.5	2.5
	5.5		4055PC	1.5	2.5	2.5	1.5	2.5
	7.5		4075PC	2.5	4	2.5	1.5	2.5
	11		4110PC	4	6	4	1.5	4
	15		4150PC	6	10	6	2.5	10
	18.5		4185PC	10	10	10	2.5	10
	22		4220PC	16	16	10	4	16
	30		4300PC	25	25	16	6	16
	37		4370PC	25	35	25	10	16
	45		4450PC	35	35	35	16	16
	55		4550PC	50	50	50	16	25
	75		4750PC	95	95	70	35	50
	90		4900PC	120	120	95	35	70
	110		4110KPC	70x2	70x2	70x2	50	95
	132		4132KPC	70x2	70x2	70x2	70	95
	160		4160KPC	120x2	95x2	150x2	95	120
200	4200KPC	150x2	120x2	150x3	150	150		
220	4220KPC	150x3	120x2	150x3	150	150		
280	4280KPC	150x3	185x2	150x4	150	120x2		

■Wire size for ND rating

Voltage class	Applicable motor (kW)	Inverter type-form		Wire size (mm <sup>2</sup> )				
				Power circuit		DC wire	Braking resistor (Optional)	Grounding wire
				Input	Output			
3-phase 240 V	0.75	VFAS3-	2004P	1.5	1.5	2.5	1.5	2.5
	1.5		2007P	1.5	1.5	2.5	1.5	2.5
	2.2		2015P	1.5	1.5	2.5	1.5	2.5
	4.0		2022P	2.5	4	2.5	1.5	4
	5.5		2037P	4	6	4	1.5	6
	7.5		2055P	6	10	6	2.5	10
	11		2075P	10	16	10	4	16
	15		2110P	16	25	16	6	16
	18.5		2150P	25	35	25	10	16
	22		2185P	35	50	35	16	25
	30		2220P	50	70	50	25	35
	37		2300P	70	95	70	35	50
	45		2370P	95	120	95	50	70
	55		2450P	70x2	70x2	50x2	50	95
	75		2550P	95x2	95x2	70x2	70	120
3-phase 480 V	0.75	VFAS3-	4004PC	1.5	1.5	2.5	1.5	2.5
	1.5		4007PC	1.5	1.5	2.5	1.5	2.5
	2.2		4015PC	1.5	1.5	2.5	1.5	2.5
	4.0		4022PC	1.5	1.5	2.5	1.5	2.5
	5.5		4037PC	1.5	2.5	2.5	1.5	2.5
	7.5		4055PC	2.5	4	2.5	1.5	2.5
	11		4075PC	4	6	4	1.5	4
	15		4110PC	6	10	6	2.5	10
	18.5		4150PC	10	10	10	2.5	10
	22		4185PC	10	16	10	4	16
	30		4220PC	16	25	16	6	16
	37		4300PC	25	35	25	10	16
	45		4370PC	35	35	35	16	16
	55		4450PC	50	50	50	16	25
	75		4550PC	70	95	70	35	50
	90		4750PC	95	120	95	35	70
	110		4900PC	50x2	50x2	70x2	35	95
	132		4110KPC	70x2	70x2	70x2	50	95
	160		4132KPC	95x2	95x2	95x2	70	120
	220		4160KPC	150x2	150x2	150x2	95	150
250	4200KPC	150x2	150x2	185x2	150	150		
280	4220KPC	150x3	120x3	150x3	150	120x2		
315	4280KPC	150x3	150x3	150x3	150	120x2		

10

Memo

- The wire size of this chapter comply with IEC60364-5-52 (Grounding wire: IEC60364-5-54). It does not comply with UL Standard.
- For the wire size to comply with UL Standard, refer to [9. 2. 3].

## 10.2 Selection of a wiring device

According to the table [10. 2. 1], select an appropriate wiring device depending on the voltage class and capacity of the inverter.

### 10.2.1 Selection table of a wiring device

Select a wiring device depending on the inverter type and input current in the table next.

#### ■ Wiring devices for HD rating

Voltage class	Applicable motor (kW)	Inverter type-form	Input current (A)	Rated current (A)		
				Molded-case circuit breaker (MCCB) Earth leakage circuit breaker (ELCB)	Magnetic contactor (MC)	
3-phase 240 V	0.4	VFAS3-	2004P	1.7	3	20
	0.75		2007P	3.3	5	20
	1.5		2015P	6.0	10	20
	2.2		2022P	9.0	15	20
	4.0		2037P	15.1	20	20
	5.5		2055P	20.1	30	32
	7.5		2075P	27.3	40	32
	11		2110P	40.0	50	50
	15		2150P	53.2	75	60
	18.5		2185P	64.8	100	80
	22		2220P	78.3	100	80
	30		2300P	104.7	150	150
	37		2370P	128.4	175	200
	45		2450P	157.6	200	260
55	2550P	189.0	250	260		

Voltage class	Applicable motor (kW)	Inverter type-form	Input current (A)	Rated current (A)		
				Molded-case circuit breaker (MCCB) Earth leakage circuit breaker (ELCB)	Magnetic contactor (MC)	
3-phase 480 V	0.4	VFAS3-	4004PC	0.9	3	20
	0.75		4007PC	1.8	3	20
	1.5		4015PC	3.2	5	20
	2.2		4022PC	4.9	10	20
	4.0		4037PC	8.3	10	20
	5.5		4055PC	10.9	15	20
	7.5		4075PC	14.7	20	20
	11		4110PC	21.4	30	32
	15		4150PC	28.9	40	32
	18.5		4185PC	35.4	50	50
	22		4220PC	42.1	60	50
	30		4300PC	57.1	75	60
	37		4370PC	69.9	100	80
	45		4450PC	84.8	125	100
	55		4550PC	103.3	125	135
	75		4750PC	139.8	175	200
	90		4900PC	170.2	225	260
	110		4110KPC	203.5	250	260
	132		4132KPC	240.3	300	260
	160		4160KPC	290.0	350	350
200	4200KPC	360.0	500	450		
220	4220KPC	395.0	500	450		
280	4280KPC	495.0	700	660		

## ■Wiring devices for ND rating

Voltage class	Applicable motor (kW)	Inverter type-form		Input current (A)	Rated current (A)	
					Molded-case circuit breaker (MCCB) Earth leakage circuit breaker (ELCB)	Magnetic contactor (MC)
3-phase 240 V	0.75	VFAS3-	2004P	3.0	5	20
	1.5		2007P	5.9	10	20
	2.2		2015P	8.5	15	20
	4.0		2022P	15.1	20	20
	5.5		2037P	20.2	30	32
	7.5		2055P	27.1	40	32
	11		2075P	39.3	50	50
	15		2110P	53.0	75	60
	18.5		2150P	65.1	100	80
	22		2185P	76.0	100	80
	30		2220P	104.7	150	150
	37		2300P	128.0	175	200
	45		2370P	154.7	200	260
	55		2450P	191.9	250	260
	75		2550P	256.0	350	350
3-phase 480 V	0.75	VFAS3-	4004PC	1.6	3	20
	1.5		4007PC	3.1	5	20
	2.2		4015PC	4.5	10	20
	4.0		4022PC	8.0	10	20
	5.5		4037PC	10.8	15	20
	7.5		4055PC	14.4	20	20
	11		4075PC	20.8	30	32
	15		4110PC	28.3	40	32
	18.5		4150PC	34.9	50	50
	22		4185PC	41.4	50	50
	30		4220PC	55.9	75	60
	37		4300PC	69.0	100	80
	45		4370PC	83.4	125	100
	55		4450PC	101.9	125	135
	75		4550PC	138.0	175	200
	90		4750PC	165.1	200	260
	110		4900PC	203.5	250	260
	132		4110KPC	240.3	300	260
	160		4132KPC	284.2	350	350
	220		4160KPC	395.0	500	450
	250		4200KPC	444.0	500	450
280	4220KPC	495.0	700	660		
315	4280KPC	555.0	1000	660		



- Install a surge absorber on the exciting coil of a magnetic contactor (MC) and relays.
- When using an auxiliary contacts 2a type magnetic contactor (MC), use the 2a contacts in parallel to increase the liability of the contacts.
- Selection is for assuming a normal power supply capacity and using a Toshiba 4-pole standard motor with input power 200 V/400 V-50 Hz.
- For the influence of the leakage current, refer to [2. 4. 3].

### **10. 2. 2 Installation of a molded-case circuit breaker (MCCB) and earth leakage circuit breaker (ELCB)**

For protection of the wiring system, install a molded-case circuit breaker (MCCB) between the power supply and the inverter (primary side).

An earth leakage circuit breaker (ELCB) that is equipped with a function to shut off by detecting leakage current can be also installed. However, be cautious that an ELCB may operate improperly, because the leakage current becomes large due to the influence of a wiring method, a built-in noise filter, etc.

Because the short-circuit current is different with power supply capacity and wiring system conditions, select MCCB or ELCB depending on the inverter type and input current in the table [10. 2. 1].

#### **Memo**

- When complying with UL Standard and CSA Standard, a fuse needs to be installed on the primary side of the inverter. For details, refer to [9. 2. 3].

### **10. 2. 3 Installation of a magnetic contactor (MC)**

When installing a magnetic contactor (MC) on the primary or secondary side of the inverter, select following the below.

#### **■ Installation on the primary side**

When the power side and the inverter need to be detached in the following cases, install a magnetic contactor (MC) between the power supply and the inverter (primary side).

Select a magnetic contactor (MC) depending on the inverter type and input current in the table [10. 2. 1].

- Thermal relay on the motor is activated
- Protection detection relay (FL) inside the inverter is activated
- Not to automatically restart at restoration of power after power failure
- When using the braking resistor (option), the thermal relay of the braking resistor is activated

To open the power circuit (primary side) when the protective function detection relay inside the inverter is activated, the molded-case circuit breaker (MCCB) with a power cutoff device can be installed instead of magnetic contactors (MC). Make sure the molded-case circuit breaker (MCCB) trips at the contact of protection detection relay. If earth leakage detector is not installed, earth leakage circuit breaker (ELCB) should be installed instead of MCCB.

A connection example for installing the primary-side magnetic contactor (MC) is shown next.

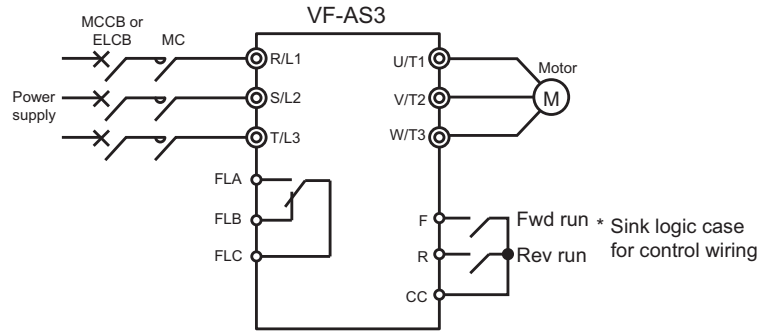

Important

- Do not run/stop the inverter by turning the magnetic contactor (MC) installed on the primary side ON/OFF. When run/stop the inverter, set the terminal [F] (forward) or terminal [R] (reverse) of the control terminal ON/OFF.
- Install a surge absorber on the exciting coil of a magnetic contactor (MC).

■ Installation on the secondary side

To switch the motor during the inverter is stopped, and change the motor power, a magnetic contactor (MC) can be installed between the inverter and motor (secondary side).

When operating the motor with commercial power supply by switching the circuit and not through the inverter, select a magnetic contactor (MC) with AC-3 Class and confirming to the motor rated current.

A connection example for installing the secondary-side magnetic contactor (MC) is shown next.

10

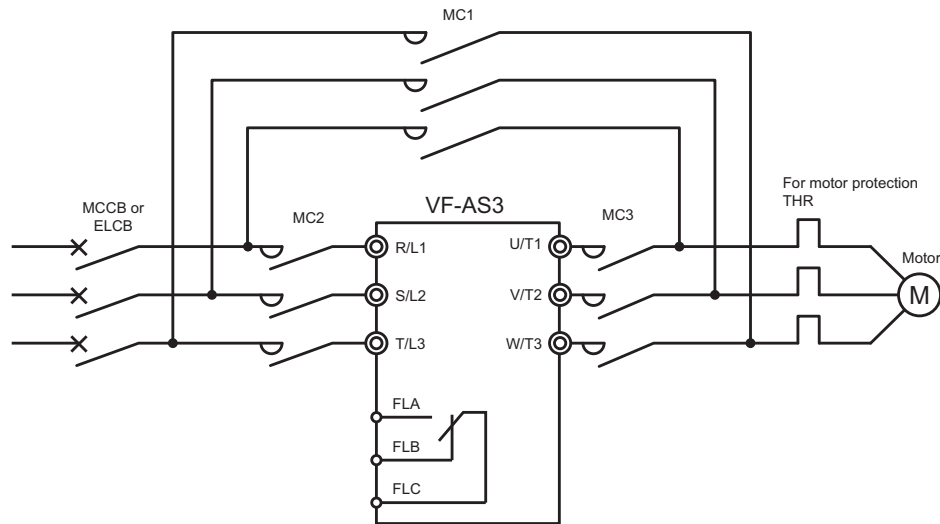



Important

- Be sure to have interlock for the commercial power supply is applied to the inverter output terminal.
- Do not turn the magnetic contactor (MC) in the secondary circuit ON/OFF during run. It can cause failure due to rush current flowing to the inverter.
- Install a surge absorber on the exciting coil of a magnetic contactor (MC).

### **10. 2. 4 Installation of a thermal relay (THR)**

Use an electronic thermal protector of the inverter for motor overload protection. Set a motor overload protection level with a parameter according to the motor rating.

However, in the following cases, install a thermal relay (THR) between the inverter and motor (secondary side).

- Running multiple motors simultaneously with one inverter.  
In this case, install a thermal relay on each motor.
- Running a motor with smaller output than applicable motor output of the standard specification  
(When the motor capacity is too small to set with a parameter of the motor overload protection level).

For details on motor overload protection level, refer to [5. 3. 5].

To give sufficient protection for the motor running in a low-speed range, the use of a motor with motor winding embedded type thermal relay is recommended.



Important

- "Thermal overload relay" is recommended, install it for each motor to be protected. "Thermal relay with CT" is not available.

## 10.3 External options

This inverter provides external options shown in the next figure.

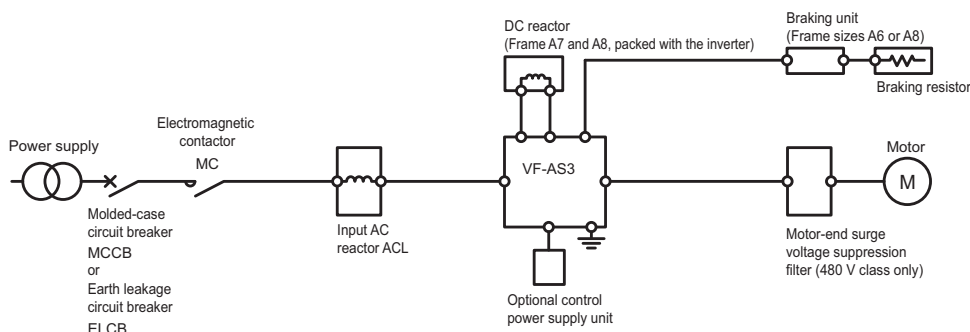

Functions, purposes, notes, etc. of individual external option are explained next. External options are shown in [10. 3. 9].

### 10.3.1 Input AC reactor, (DC reactor)

Input AC reactor is used for improving input power factor on the inverter power side (primary side), reducing harmonics or restriction of surge voltage.

It is also installed when the power supply capacity is 500 kVA or more and is 10 times or more of the inverter capacity, and when devices that cause distorted waves (a device with thyristor, etc.) and a large capacity inverter is connected on the same power distribution line. Install an input AC reactor between the power supply and the inverter (primary side).

10

A DC reactor is a reactor to connect with the DC terminal, and used for improving input power factor and reducing harmonics. It has better power factor improvement effect than an input AC reactor. When a facility applying the inverter requires high reliability, it is recommended to use with an input AC reactor that has surge voltage restriction effect.

However, the frame size A1 to A6 of the inverter has a built-in DC reactor as standard, and the frame size A7 and A8 attached with a DC reactor, no option is available.

Type	Effect		
	Power factor improvement	Harmonics reduction	Surge voltage restriction
Input AC reactor	Enabled	Enabled	Enabled
DC reactor	Enabled (large)	Enabled (large)	Disabled

### **10. 3. 2 Braking resistor, Braking unit**

It is a resistor to consume regenerative energy from a motor.

When making frequent rapid deceleration and stop, it is used to shorten deceleration time with load in large inertia.

A braking unit is necessary in addition to a braking resistor for the frame size A6 and A8.

For details on using a braking resistor, refer to [6. 15. 4].

### **10. 3. 3 Motor-end surge voltage suppression filter**

When operating a 480 V class general purpose motor with a voltage type PWM control inverter that uses high speed switching element (IGBT, etc.), surge voltage exceeding the insulation level of motor winding is generated depending on power supply voltage, motor wire length and its laying method, and type. When the condition is repeatedly applied for a long time, it may cause deterioration of insulation on the motor.

Such measures as installation of an AC reactor, surge voltage suppression filter on the inverter output side (secondary side), and use of a high insulation strength motor are necessity.

- To be installed floor horizontal mounting.
- To be used that carrier frequency is 15kHz or less, and output frequency is 60Hz or less.

For details of carrier frequency, refer to [6. 14].

### **10. 3. 4 Optional control power supply**

This inverter supplies control power supply from the power supply inside the inverter. When control power supply is backed up with this option, display and output signal can be maintained in case of power supply shut off.

- It is common with 240 V/480 V class.
- Type-form: CPS002Z

### **10. 3. 5 LED extension panel option**

It is an extension panel for LED display. A specific cable is used to connect between the inverter and LED panel.

When using this panel, remove the standard operation panel, and connect to the RS485 communication connector 1.

- Panel type-form: RKP002Z  
Specific cable type-form: CAB0011 (1 m), CAB0013 (3 m), CAB0015 (5 m)
- Panel type-form: RKP007Z  
Specific cable type-form: CAB0071 (1 m), CAB0073 (3 m), CAB0075 (5 m)

### **10. 3. 6 USB communication conversion unit**

It enables to set and manage parameters on a personal computer.

Connect between the RS485 communication connector 1 of the inverter and a personal computer. Use the specific cable for the inverter side, and a commercial USB cable (USB 1.1/2.0 compatible A-B connection type) for a personal computer side. Software PCM002Z for parameter management is required.

- Type-form: USB001Z
- Specific cable type-form: CAB0011 (1 m), CAB0013 (3 m), CAB0015 (5 m)

### **10. 3. 7 Flange mounting kit**

It reduces heat rising up inside the cabinet.

### **10. 3. 8 Door mounting kit**

It enables to mount operation panel on the cabinet door. Use the exclusive cable for interconnection between this kit and the inverter. For detail, refer to “Door mounting kit instruction manual” (E6582159).

- Type-form: SBP010Z
- Specific cable type-form: CAB0071 (1 m), CAB0073 (3 m), CAB0075 (5 m) , CAB00710 (10 m)

#### **How to remove operation panel**

While pressing the PUSH part located on both right and left sides of the operation panel, pull the operation panel straight upward.

#### **How to mount operation panel again**

Push the operation panel with fixing the connector back side on RS485 communication connector 1 on control block.

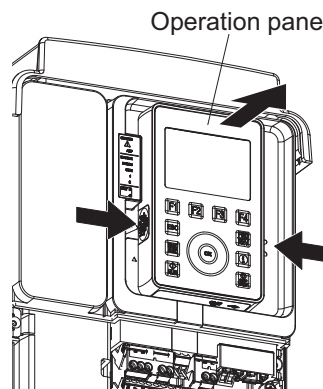

**10**

### **10. 3. 9 External option list**

External options are shown in the next table.

Category	Product name	Specification / Ranges	Type-form	Remarks
Control option	Door mounting kit	Door mounting kit for operation panel	SBP010Z	Coming soon
	Option adapter	For Safety option & For using case of 3 options	SBP011Z	Coming soon

Category	Product name	Specification / Ranges	Type-form	Remarks
Power option	Flange mounting kit	For Frame size A1 to A5	FOT018Z to FOT022Z	
	Flange mounting kit	For Frame size A6	FOT023Z	Coming soon
	Flange mounting kit	For Frame size A7	FOT013Z	
	Flange mounting kit	For Frame size A8	FOT014Z	
	Braking unit	For Frame size A6	PB7-4132K	Coming soon
	Braking unit	For Frame size A8	PB7-4200K	
	Braking resistor	All ranges	PBR-xxxx*1	
	Input reactor	All ranges	PFL-xxxxS*1	
	Motor end surge suppression filter	480 V all ranges	MSF-4xxxZ*1	
Others	LED extension panel	Big LED keypad	RKP002Z	
	LED extension panel	Small LED keypad	RKP007Z	
	Control power supply unit	DC24V backup option	CPS002Z	
	USB communication conversion unit	Converter between RS485 (Inverter) and USB (PC)	USB001Z	

\*1 xxx (number) varies depending on capacity.

## 10.4 Insert type options

This inverter is equipped with two option slots (A, B) as standard. The option adapter (option) can be mounted for an extended slot.

### 10.4.1 Insert type options and functions



Cassette options are available as shown in the next table.

#### ■ Cassette options

Name	Specification	Type-form	Slot availability	Remarks
I/O extension 1	6x digital input 2x digital output 2x analog input	ETB013Z	A, B, C	Refer to E6582128
I/O extension 2	3x 1a relay	ETB014Z	A, B, C	Refer to E6582129
Digital encoder	RS422 Line receiver	VEC008Z	B	Refer to E6582140 and E6582148
Resolver	Resolver	VEC010Z	B	Coming soon
Safety module	SS1, SS2, SOS, SBC, SMS, SLS, SDI, SSM	SFT001Z	C	Coming soon
PROFINET	PROFINET interface	PNE001Z	A	
EtherCAT	EtherCAT interface	IPE003Z	A	Coming soon
PROFIBUS-DP	PROFIBUS-DP interface	PDP003Z	A	
DeveceNet	DeviceNet interface	DEV003Z	A	
CANopen	CANopen interface RJ45 D-sub Open style	CAN001Z CAN002Z CAN003Z	A	Coming soon



## 10. 4. 2 Mounting/removing insert type options

 <b>WARNING</b>	
 Prohibited	<ul style="list-style-type: none"> <li>Do not connect any communication options other than supported by option slots. It can cause failure and accident.</li> </ul>
 Mandatory action	<ul style="list-style-type: none"> <li>Mounting/removing options should be performed 15 minutes or more after the power is shut off, and checking the charge lamp of the inverter is OFF. The inverter and options may be damaged.</li> <li>Do not use tools for mounting/removing options. The inverter and options may be damaged.</li> </ul>

Mounting/removing methods of a cassette option to the option slot A, B are as follows. When using the option slot 3, refer to [10. 4. 3].

### ■ Mounting (Option slot A, B)

- Remove the front cover and other parts.  
Covers to be removed at the time of wiring vary depending on the frame size.  
For how to remove, refer to [2. 2].

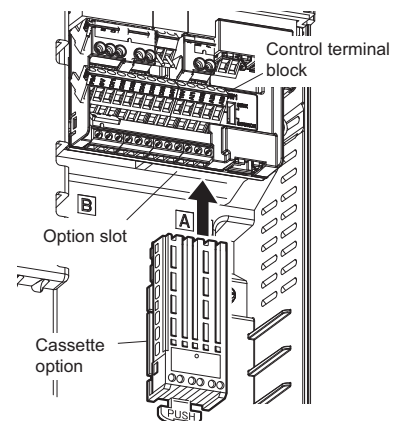

- Insert a cassette option to the option slot A, B until you hear a click sound.
- Perform wiring to the cassette option.
- When wiring is complete, mount the removed cover.  
For how to mount them, refer to [2. 2].

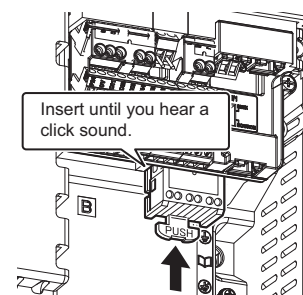

### ■ Removing (Option slot A, B)

- Remove the front cover and other parts.  
Covers to be removed vary depending on the frame size.  
For how to remove, refer to [2. 2].
- Remove wiring to the cassette option.

- 3 While pressing the release tab down, pull the cassette option to remove from the option slot.

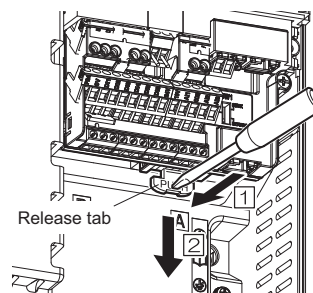

- 4 Mount the removed covers.  
For how to mount them, refer to [2. 2].



Important

- Do not use excessive force to press a cassette option to the option slot, or the connector pin may be damaged. Along the guide, insert straight slowly.
- Depending on a cassette option, insertion to the option slot A, B may not be possible. Refer to [10. 4. 1].
- In the case of frame size A7 or A8, remove the wire-holding fitting mounted at the lower part of the option slot A, B before inserting/removing the cassette option.

### 10. 4. 3 Mounting/removing the option adapter

Mounting/removing methods of the option 3 slot adapter are as follows.

Mounting and removing methods of a cassette option is the same with option slot A, B. For details, refer to [10. 4. 2].

#### ■ Mounting of option

- 1 Remove the front covers and other parts in advance. Covers to be removed at the time of wiring vary depending on the frame size of inverter.
- 2 While pressing the PUSH part located on both right and left sides of the operation panel, pull the operation panel straight upward.  
The operation panel is connected to the unit with the connector on the center of back side.

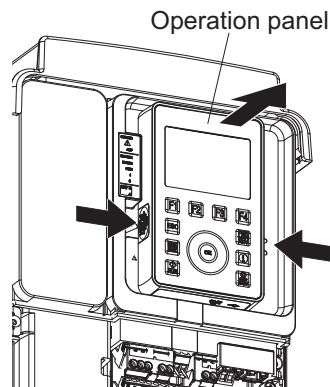

- 3 Remove the protection label.
- 4 Remove the connector cover.  
Store the removed parts so as not to be lost.
- 5 Remove the option wiring cover.  
The option wiring cover can be removed by fingers.  
Store the removed parts so as not to be lost.
- 6 Match the position of the Option adaptor connector with the inverter, and mount the Option adaptor.  
Store the removed parts so as not to be lost.
- 7 Tighten the screw.  
This screw is used to connect ground for option.

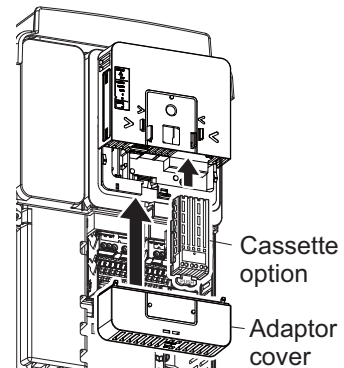
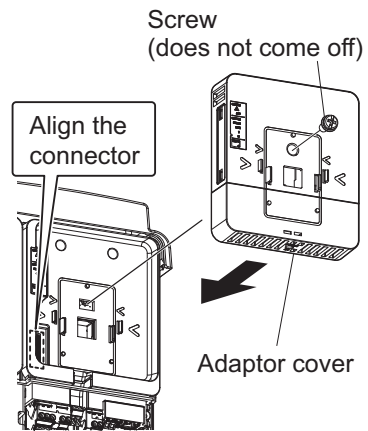
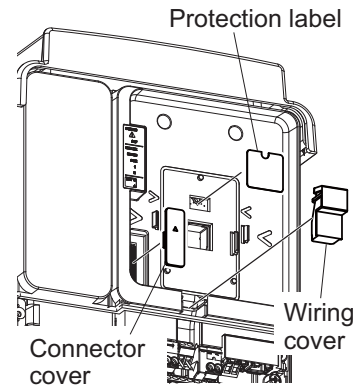

- 8 Insert a screwdriver, etc. to the lock removal hole of the adaptor cover to push and unlock, and remove the adaptor cover upward. In this state, a cassette option can be inserted to slot C.  
Using the groove of removed wiring cover, perform wiring of the cassette option before inserting the option, and fix the wiring by the attached cable tie.

- 9 After wiring is complete, mount the adaptor cover on the Option adaptor.  
Be cautious that the wiring of the cassette option does not get pinched by the adaptor cover.  
The removed operation panel can be installed on top surface of the Option adaptor.
- 10 Mount the removed front covers.

■ **Removing of option**

- 1 Remove the front covers and other parts in advance. Covers to be removed at the time of wiring vary depending on the frame size of inverter.
- 2 While pressing the PUSH part located on both right and left sides of the operation panel, pull the operation panel straight upward.  
The operation panel is connected to the unit with the connector on the center of back side.

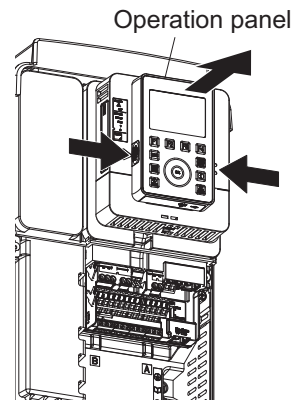
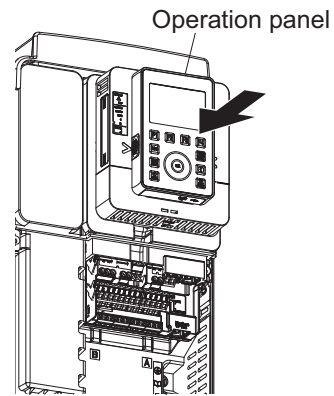

- 3 Insert a screwdriver, etc. to the lock removal hole of the Option adaptor cover to push and unlock, and remove the adaptor cover of the Option adaptor.
- 4 Remove wiring to the cassette option.

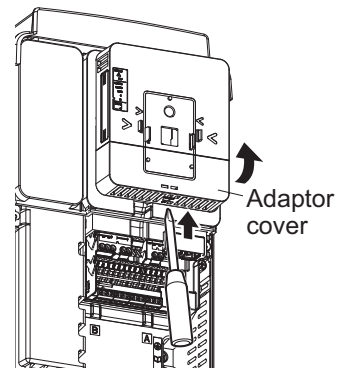

**10**

- 5 While pressing the release tab down, pull the cassette option to remove from slot C.

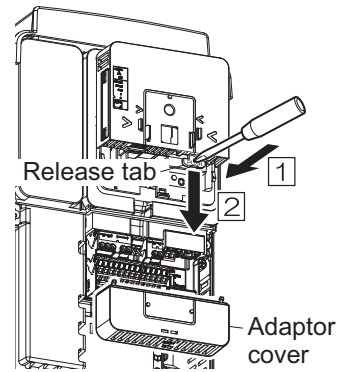

- 6 Remove the Option adaptor. Mount the adaptor cover removed before.

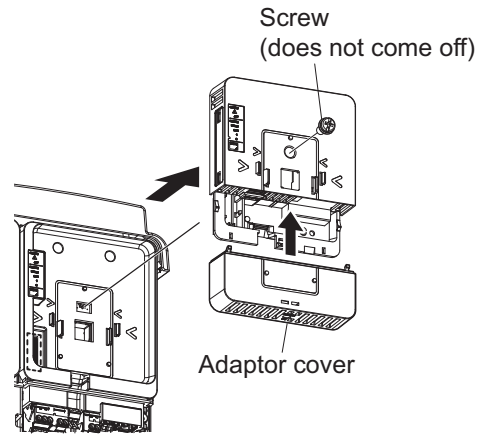

- 7 While pressing the PUSH part located on both right and left sides of the operation panel, pull the operation panel straight upward. The operation panel is connected to the unit with the connector on the center of back side.

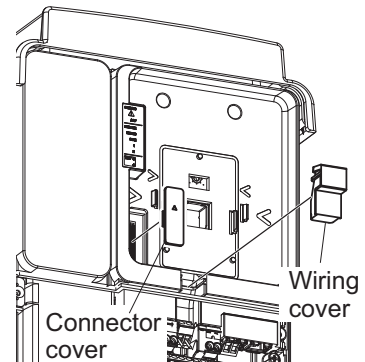

**10**



# 11 Table of parameters

I

II

## 11.1 Frequency setting parameter

1

2

3

4

5

6

7

8

9

10

11

12

13

14

15

16

Title	Parameter name	Adjustment range	Unit	Minimum setting unit (Panel/Communication)	Default setting	Write during running*6	User setting	Reference
FC	Panel run frequency	LL - UL	Hz	0.1/0.01	0.0	Y		[4. 3. 1]

\*1 Parameter values vary depending on the capacity. For details, refer to [11. 6].

\*2 Depending on the setup menu. Refer to [11. 10].

\*3 For details on the analog output and monitor output function, refer to [11. 7].

\*4 Refer to section [11. 8] for details about the input terminal function.

\*5 Refer to section [11. 9] for details about the output terminal function.

\*6 Y: Writable N: Not writable

## 11.2 Basic parameter

Title	Communication No.	Parameter name	Adjustment range	Unit	Minimum setting unit (Panel/Communication)	Default setting	Write during running *6	User setting	Reference
AUH	-	History function	-	-	-	0	-		[4. 2. 1]
AUF	0093	Guidance function	0: - 1: Embedded Ethernet setting 2: Preset speed operation 3: Analog frequency command 4: Motor 1, 2 switching 5: Motor parameter 6: PM motor parameter	-	-	0	N		[4. 2. 1]
AUA	0090	Application easy setting	0: - 1: Initial easy setting 2: Conveyor 3: Material handling 4: Hoisting 5: Fan 6: Pump 7: Compressor	-	-	0	N		-
AUE	0032	Eco-standby power setting	0: - +1: Embedded Ethernet OFF	-	-	0	N		[5. 3. 1]
AUL	0094	Multi-rating select	0: - 1: - 2: ND rating (120%-60s) (0 after execution) 3: HD rating (150%-60s) (0 after execution) 4 - 8: -	-	-	0	N		[1. 2] [5. 3. 2]
AU1	0000	Automatic Acc/Dec	0: Disabled 1: Automatic Acc/Dec 2: Automatic Acc only	-	-	0	N		[5. 3. 3]
AU2	0001	Torque boost macro	0: Disabled 1: Automatic torque boost + offline auto-tuning 2: Vector control 1 + offline auto-tuning 3: Energy savings + offline auto-tuning	-	-	0	N		[5. 3. 4] [5. 3. 5] [6. 23. 1]
CMOd	0003	Run command select	0: Terminal 1: Operation panel, Extension panel 2: Embedded Ethernet 3: RS485 communication (connector 1) 4: RS485 communication (connector 2) 5: Communication option	-	-	0	N		[4. 3. 1] [4. 4. 1] [5. 2. 1]



Title	Communication No.	Parameter name	Adjustment range	Unit	Minimum setting unit (Panel/Communication)	Default setting	Write during running *6	User setting	Reference
FMOd	0004	Frequency command select 1	0: - 1: Terminal RR 2: Terminal RX 3: Terminal II 4: Terminal AI4 (option) 5: Terminal AI5 (option) 6 - 9: - 10: Touch wheel 1 (power off or press OK to save) 11: Touch wheel 2 (press OK to save) 12: Sr0 13,14: - 15: Terminal Up/Down frequency 16: Pulse train 17: High resolution pulse train (option) 18,19: - 20: Embedded Ethernet 21: RS485 communication (connector 1) 22: RS485 communication (connector 2) 23: Communication option	-	-	1	N		[4. 3. 1] [4. 4. 1] [5. 2. 1] [5. 4. 1] [7. 3. 2] [7. 3. 3] [7. 3. 4]
Pt	0015	V/f Pattern	0: V/f constant 1: Variable torque 2: Automatic torque boost 3: Vector control 1 4: Energy savings 5: Dynamic energy savings (for fan and pump) 6: PM motor control 7: V/f 5-point setting 8: - 9: Vector control 2 (speed / torque) 10: PG feedback control 11: PG feedback vector control (speed / torque) 12: -	-	-	0	N		[5. 3. 4] [5. 3. 5] [6. 23. 1] [6. 23. 2]
vb	0016	Manual torque boost 1	0.00 - 30.00	%		*1	Y		[5. 3. 6]
vL	0014	Base frequency 1	15.0 - 590.0	Hz		50.0 / 60.0 *2	Y		[5. 2. 2]
vLv	0409	Base frequency voltage 1	240V class: 50-330V 480V class: 50-660V	V		*2	Y		[5. 2. 2]
FH	0011	Maximum frequency	30.0 - 590.0	Hz		*2	N		[5. 2. 3]
UL	0012	Upper limit frequency	0.0 - FH	Hz		50.0 / 60.0 *2	Y		[5. 2. 3]
LL	0013	Lower limit frequency	0.0 - UL	Hz		0.0	Y		[5. 2. 3] [6. 9]
ACC	0009	Acceleration time 1	0.0 - 6000 (600.0)	s		*1	Y		[5. 2. 4] [5. 3. 3] [6. 27. 2]

Title	Communication No.	Parameter name	Adjustment range	Unit	Minimum setting unit (Panel/Communication)	Default setting	Write during running *6	User setting	Reference
dEC	0010	Deceleration time 1	0.0 - 6000 (600.0)	s		*1	Y		[5. 2. 4] [5. 3. 3] [6. 27. 2]
Sr0	0030	Preset speed 0	LL - UL	Hz		0.0	Y		[5. 3. 7]
Sr1	0018	Preset speed 1	LL - UL	Hz		0.0	Y		[4. 4. 3] [5. 3. 7] [6. 28]
Sr2	0019	Preset speed 2	LL - UL	Hz		0.0	Y		
Sr3	0020	Preset speed 3	LL - UL	Hz		0.0	Y		
Sr4	0021	Preset speed 4	LL - UL	Hz		0.0	Y		[5. 3. 7] [6. 28]
Sr5	0022	Preset speed 5	LL - UL	Hz		0.0	Y		
Sr6	0023	Preset speed 6	LL - UL	Hz		0.0	Y		
Sr7	0024	Preset speed 7	LL - UL	Hz		0.0	Y		
FPId	0025	PID1 set value	F368 - F367	Hz		0.0	Y		[5. 3. 8] [6. 21]
Fr	0008	Panel Fwd/Rev run select	0: Fwd run 1: Rev run 2: Fwd run (switchable F/R by panel) 3: Rev run (switchable F/R by panel)	-	-	0	Y		[4. 3. 2] [5. 3. 9]
tHrA	0031	Motor overload protection current 1	Depending on capacity *1	A		*1	Y		[5. 2. 5]
OLM	0017	Motor overload protection characteristic	0: Standard motor, OL2, No stall 1: Standard motor, OL2, Stall 2: Standard motor, No OL2 trip, No stall 3: Standard motor, No OL2 trip, Stall 4: Constant torque motor, OL2, No stall 5: Constant torque motor, OL2, Stall 6: Constant torque motor, No OL2 trip, No stall 7: Constant torque motor, No OL2 trip, Stall	-	-	0	Y		[5. 2. 5]
FMSL	0005	Terminal FM function	0 - 162 *3	-	-	0	Y		[5. 2. 6]
FM	0006	Terminal FM adjustment	-	-	-	-	Y		

Title	Communication No.	Parameter name	Adjustment range	Unit	Minimum setting unit (Panel/Communication)	Default setting	Write during running *6	User setting	Reference
tyP	0007	Default setting	0: - 1: 50Hz setting 2: 60Hz setting 3: Default setting 1 4: Clear past trips 5: Clear cumulative run time 6: Initialize type form 7: Store user settings 8: Rewrite user settings 9: Clear cumulative fan run time 10,11: - 12: Clear number of starting 13: Default setting 2 (complete initialization) 14: Clear number of external equipment starting 15: Clear cumulative overcurrent time	-	-	0	N		[5. 2. 9]
SEt	0099	Region setting check	0: Setup menu starting 1: Japan (read only) 2: Mainly North America (read only) 3: Mainly Asia (read only) 4: Mainly Europe (read only) 5: Mainly China (read only)	-	-	0	N		[5. 3. 10]
PSEL	0050	Parameter mode select	0: Setting mode at power on 1: Easy mode at power on 2: Easy mode only	-	-	0	Y		[5. 2. 8]
F1--	-	Head of F100	-	-	-	-	-		[11. 3]
F2--	-	Head of F200	-	-	-	-	-		
F3--	-	Head of F300	-	-	-	-	-		
F4--	-	Head of F400	-	-	-	-	-		
F5--	-	Head of F500	-	-	-	-	-		
F6--	-	Head of F600	-	-	-	-	-		
F7--	-	Head of F700	-	-	-	-	-		
F8--	-	Head of F800	-	-	-	-	-		
F9--	-	Head of F900	-	-	-	-	-		
A---	-	Start of A	-	-	-	-	-		[11. 4]
C---	-	Start of C	-	-	-	-	-		[11. 5]
GrU	-	Changed parameters search & edit	-	-	-	-	-		-

\*1 Parameter values vary depending on the capacity. For details, refer to [11.6].  
 \*2 Depending on the setup menu. Refer to [11.10].  
 \*3 For details on the analog output and monitor output function, refer to [11.7].  
 \*4 Refer to section [11.8] for details about the input terminal function.  
 \*5 Refer to section [11.9] for details about the output terminal function.  
 \*6 Y: writable N: Not writable

## 11.3 Extended parameter

Title	Communication No.	Parameter name	Adjustment range	Unit	Minimum setting unit (Panel/Communication)	Default setting	Write during running *6	User setting	Reference
F100	0100	Low-speed signal output frequency	0.0 - FH	Hz		0.0	Y		[2. 4. 1] [6. 1. 1]
F101	0101	Reach signal specified frequency	0.0 - FH	Hz		0.0	Y		[6. 1. 3]
F102	0102	Reach signal detection band	0.0 - FH	Hz		2.5	Y		[6. 1. 2] [6. 1. 3]
F105	0105	Fwd/Rev priority of both close	0: Reverse 1: Stop	-	-	1	N		[6. 2. 1]
F107	0107	Terminal RX input voltage select	0: 0 to +10 V 1: -10 to +10 V	-	-	0	N		[6. 2. 2] [6. 6. 2] [7. 3. 1] [7. 3. 4]
F108	0108	Terminal RR input select	1: Voltage input (0-10 V) 2: - 3: - 4: PTC input 5: PT100 (2-wire) input 6: - 7: PT1000 (2-wire) input 8: - 9: KTY84 input	-	-	1	N		[6. 2. 3] [6. 6. 2] [6. 30. 19]
F110	0110	Always active function 1	0 - 177*4	-	-	6	N		[6. 3. 1] [7. 2. 1]

Title	Communication No.	Parameter name	Adjustment range	Unit	Minimum setting unit (Panel/Communication)	Default setting	Write during running *6	User setting	Reference
F111	0111	Terminal F function 1	0 - 203*4	-	-	2	N		[7. 2. 1]
F112	0112	Terminal R function 1		-	-	4	N		
F113	0113	Terminal RES function 1		-	-	8	N		
F114	0114	Terminal S1 function 1		-	-	10	N		
F115	0115	Terminal S2 function		-	-	12	N		
F116	0116	Terminal S3 function		-	-	14	N		
F117	0117	Terminal S4 function		-	-	16	N		
F118	0118	Terminal S5 function		-	-	118	N		
F119	0119	Terminal DI11 function		-	-	0	N		
F120	0120	Terminal DI12 function		-	-	0	N		
F121	0121	Terminal DI13 function	-	-	0	N			
F122	0122	Terminal DI14 function	-	-	0	N			
F123	0123	Terminal DI15 function	-	-	0	N			
F124	0124	Terminal DI16 function	0 - 203*4	-	-	0	N		
F127	0127	Always active function 2	0 - 177*4	-	-	0	N		[6. 3. 1] [7. 2. 1]
F128	0128	Always active function 3		-	-	0	N		
F130	0130	Terminal FP function 1	0 - 255*5	-	-	6	N		[7. 2. 2]
F132	0132	Terminal FL function		-	-	10	N		
F133	0133	Terminal R1 function 1		-	-	4	N		
F134	0134	Terminal R2 function		-	-	254	N		

Title	Communication No.	Parameter name	Adjustment range	Unit	Minimum setting unit (Panel/Communication)	Default setting	Write during running *6	User setting	Reference
F135	0135	Terminal R1 delay time	0.0 - 60.0	s		0.0	N		
F136	0136	Terminal R2 delay time	0.0 - 60.0	s		0.0	N		
F137	0137	Terminal FP function 2	0 - 255*5	-	-	255	N		
F138	0138	Terminal R1 function 2		-	-	255	N		[7. 2. 2]
F139	0139	Terminal FP, R1 logic select	0: F130 and F137, F133 and F138 1: F130 and F137, F133 or F138 2: F130 or F137, F133 and F138 3: F130 or F137, F133 or F138	-	-	0	N		
F140	0140	Terminal F response time	1 - 1000	ms		1	N		
F141	0141	Terminal R response time	1 - 1000	ms		1	N		
F142	0142	Terminal RES response time	1 - 1000	ms		1	N		
F143	0143	Terminal S1 response time	1 - 1000	ms		1	N		[7. 2. 1]
F144	0144	Terminal S2-S5 response time	1 - 1000	ms		1	N		
F145	0145	Terminal DI11-DI16 response time	1 - 1000	ms		1	N		
F146	0146	Terminal S4 input select	0: Digital input. 1: Pulse train input 2: PG input	-	-	0	N		[6. 6. 4] [7. 2. 1]
F147	0147	Terminal S5 input select	0: Digital input. 1: Pulse train input 2: PG input	-	-	0	N		
F148	0148	Terminal AI4 input select	1: Voltage input (0-10 V) 2: Voltage input (-10 to +10V) 3: Current input (0-20 mA) 4: PTC input 5: PT100 (2-wire) input 6: PT100 (3-wire) input 7: PT1000 (2-wire) input 8: PT1000 (3-wire) input 9: KTY84 input	-	-	1	N		[6. 2. 4] [6. 6. 2]
F149	0149	Terminal AI5 input select	1: Voltage input (0-10 V) 2: Voltage input (-10 to +10V) 3: Current input (0-20 mA) 4: PTC input 5: PT100 (2-wire) input 6: PT100 (3-wire) input 7: PT1000 (2-wire) input 8: PT1000 (3-wire) input 9: KTY84 input	-	-	1	N		[6. 30. 19] [7. 2. 1]

11

Title	Communication No.	Parameter name	Adjustment range	Unit	Minimum setting unit (Panel/Communication)	Default setting	Write during running *6	User setting	Reference
F151	0151	Terminal F function 2	0 - 203*4	-	-	0	N		[7. 2. 1]
F152	0152	Terminal R function 2		-	-	0	N		
F153	0153	Terminal RES function 2		-	-	0	N		
F154	0154	Terminal S1 function 2		-	-	0	N		
F155	0155	Terminal F function 3		-	-	0	N		
F156	0156	Terminal R function 3		-	-	0	N		
F157	0157	Terminal RES function 3		-	-	0	N		
F158	0158	Terminal S1 function 3		-	-	0	N		
F159	0159	Terminal DQ11 function	0 - 255*5	-	-	254	N		[7. 2. 2]
F160	0160	Terminal DQ12 function		-	-	254	N		
F161	0161	Terminal R4 function		-	-	254	N		
F162	0162	Terminal R5 function		-	-	254	N		
F163	0163	Terminal R6 function		-	-	254	N		
F170	0170	Base frequency 2	15.0 - 590.0	Hz		50.0 / 60.0 *2	Y		[6. 4]
F171	0171	Base frequency voltage 2	240V class: 50-330V 480V class: 50-660V	V		*2	Y		
F172	0172	Manual torque boost 2	0.00 - 30.00	%		*1	Y		
F173	0173	Parameter for manufacturer	-	-	-	-	-		-
F174	0174	Base frequency 3	15.0 - 590.0	Hz		50.0/ 60.0 *2	Y		[6. 4]
F175	0175	Base frequency voltage 3	240V class: 50-330V 480V class: 50-660V	V		*2	Y		
F176	0176	Manual torque boost 3	0.00 - 30.00	%		*1	Y		
F177	0177	Parameter for manufacturer	-	-	-	-	-		-
F178	0178	Base frequency 4	15.0 - 590.0	Hz		50.0/ 60.0 *2	Y		[6. 4]
F179	0179	Base frequency voltage 4	240V class: 50-330V 480V class: 50-660V	V		*2	Y		
F180	0180	Manual torque boost 4	0.00 - 30.00	%		*1	Y		

Title	Communication No.	Parameter name	Adjustment range	Unit	Minimum setting unit (Panel/Communication)	Default setting	Write during running *6	User setting	Reference
F181	0181	Parameter for manufacturer	-	-	-	-	-		-
F182	0182	Motor overload protection current 2	Depending on capacity *1	A		*1	Y		[6. 4]
F183	0183	Motor overload protection current 3		A		*1	Y		
F184	0184	Motor overload protection current 4		A		*1	Y		
F185	0185	Stall prevention level 2	10-200 (HD) 10-160 (ND)	% (A)		150 (HD) 120 (ND)	Y		[6. 30. 2]
F190	0190	V/f 5-point VF1 frequency	0.0 - FH	Hz		0.0	N		[5. 3. 4]
F191	0191	V/f 5-point VF1 voltage	0.0 - 125.0	% (V)		0.0	N		
F192	0192	V/f 5-point VF2 frequency	0.0 - FH	Hz		0.0	N		
F193	0193	V/f 5-point VF2 voltage	0.0 - 125.0	% (V)		0.0	N		
F194	0194	V/f 5-point VF3 frequency	0.0 - FH	Hz		0.0	N		
F195	0195	V/f 5-point VF3 voltage	0.0 - 125.0	% (V)		0.0	N		
F196	0196	V/f 5-point VF4 frequency	0.0 - FH	Hz		0.0	N		
F197	0197	V/f 5-point VF4 voltage	0.0 - 125.0	% (V)		0.0	N		
F198	0198	V/f 5-point VF5 frequency	0.0 - FH	Hz		0.0	N		
F199	0199	V/f 5-point VF5 voltage	0.0 - 125.0	% (V)		0.0	N		
F200	0200	Frequency command priority select	0: FMOd/F207 (switched by TB) 1: FMOd/F207 (switched by F208)	-	-	0	Y		[5. 4. 1] [6. 6. 1]
F201	0201	RR point 1 input value	0 - 100	%		0	Y		[6. 6. 2] [7. 3. 1] [7. 3. 2]
F202	0202	RR point 1 frequency	0.0 - 590.0	Hz		0.0	Y		
F203	0203	RR point 2 input value	0 - 100	%		100	Y		
F204	0204	RR point 2 frequency	0.0 - 590.0	Hz		50.0/ 60.0 *2	Y		
F205	0205	RR point 1 rate	0 - 250	%		0	Y		[6. 6. 2]
F206	0206	RR point 2 rate	0 - 250	%		100	Y		

11



Title	Communication No.	Parameter name	Adjustment range	Unit	Minimum setting unit (Panel/Communication)	Default setting	Write during running *6	User setting	Reference
F207	0207	Frequency command select 2	0: - 1: Terminal RR 2: Terminal RX 3: Terminal II 4: Terminal AI4 (option) 5: Terminal AI5 (option) 6 - 9: - 10: Touch wheel 1 (power off or press OK to save) 11: Touch wheel 2 (press OK to save) 12: Sr0 13,14: - 15: Terminal Up/Down frequency 16: Pulse train 17: High resolution pulse train (option) 18,19: - 20: Embedded Ethernet 21: RS485 communication (connector 1) 22: RS485 communication (connector 2) 23: Communication option	-	-	3	N		[5. 4. 1] [6. 6. 1]
F208	0208	Frequency command switching frequency	0.1 - FH	Hz		0.1	Y		
F209	0209	Analog input filter	1: Disabled 2 - 1000	ms		1	Y		
F210	0210	RX point 1 input value	-100 to +100	%		0	Y		
F211	0211	RX point 1 frequency	0.0 - 590.0	Hz		0.0	Y		[6. 6. 2] [7. 3. 1] [7. 3. 4]
F212	0212	RX point 2 input value	-100 to +100	%		100	Y		
F213	0213	RX point 2 frequency	0.0 - 590.0	Hz		50.0/ 60.0 *2	Y		
F214	0214	RX point 1 rate	-250 to +250	%		0	Y		[6. 6. 2]
F215	0215	RX point 2 rate	-250 to +250	%		100	Y		
F216	0216	II point 1 input value	0 - 100	%		20	Y		
F217	0217	II point 1 frequency	0.0 - 590.0	Hz		0.0	Y		[6. 6. 2] [7. 3. 1] [7. 3. 3]
F218	0218	II point 2 input value	0 - 100	%		100	Y		
F219	0219	II point 2 frequency	0.0 - 590.0	Hz		50.0/ 60.0 *2	Y		
F220	0220	II point 1 rate	0 - 250	%		0	Y		[6. 6. 2]
F221	0221	II point 2 rate	0 - 250	%		100	Y		

Title	Communication No.	Parameter name	Adjustment range	Unit	Minimum setting unit (Panel/Communication)	Default setting	Write during running *6	User setting	Reference
F222	0222	AI4 point 1 input value	-100 to +100	%		0	Y		[6. 6. 2] [7. 3. 1]
F223	0223	AI4 point 1 frequency	0.0 - 590.0	Hz		0.0	Y		
F224	0224	AI4 point 2 input value	-100 to +100	%		100	Y		
F225	0225	AI4 point 2 frequency	0.0 - 590.0	Hz		50.0/ 60.0 *2	Y		
F226	0226	AI4 point 1 rate	-250 to +250	%		0	Y		
F227	0227	AI4 point 2 rate	-250 to +250	%		100	Y		[6. 6. 2]
F228	0228	AI5 point 1 input value	-100 to +100	%		0	Y		[6. 6. 2] [7. 3. 1]
F229	0229	AI5 point 1 frequency	0.0 - 590.0	Hz		0.0	Y		
F230	0230	AI5 point 2 input value	-100 to +100	%		100	Y		
F231	0231	AI5 point 2 frequency	0.0 - 590.0	Hz		50.0/ 60.0 *2	Y		
F234	0234	Pulse train input point 1 input value	0 - 100	%		0	Y		[6. 6. 4]
F235	0235	Pulse train input point 1 frequency	0.0 - 590.0	Hz		0.0	Y		
F236	0236	Pulse train input point 2 input value	0 - 100	%		100	Y		
F237	0237	Pulse train input point 2 frequency	0.0 - 590.0	Hz		50.0/ 60.0 *2	Y		
F239	0239	Parameter for manufacturer	-	-	-	-	-		-
F240	0240	Start frequency	0.0 - 10.0	Hz		0.1	Y		[6. 7. 1]
F241	0241	Run frequency	0.0 - FH	Hz		0.0	Y		[6. 7. 2]
F242	0242	Run frequency hysteresis	0.0 - FH	Hz		0.0	Y		
F243	0243	End frequency	0.0 - 30.0	Hz		0.0	Y		[6. 7. 1]
F244	0244	0 Hz dead band	0.0 - 5.0	Hz		0.0	Y		[6. 7. 3]
F249	0249	DC braking carrier frequency	1.0 - 16.0	kHz		*1	Y		[6. 8. 1]
F250	0250	DC braking frequency	0.0 - FH	Hz		0.0	Y		[6. 8. 1] [6. 8. 3]
F251	0251	DC braking current	0 - 100	%		50	Y		[6. 8. 1] [6. 30. 4]
F252	0252	DC braking time	0.0 - 25.5	s		1.0	Y		[6. 8. 1] [6. 8. 3]
F253	0253	Fwd/Rev DC braking priority	0: Disabled 1: Enabled	-	-	0	Y		[6. 8. 1]
F254	0254	Motor shaft fixing control	0: Disabled 1: Enabled	-	-	0	Y		[6. 8. 2]
F255	0255	0Hz command select at stop	0: DC braking 1: 0 Hz command	-	-	0	N		[6. 8. 3]

Title	Communication No.	Parameter name	Adjustment range	Unit	Minimum setting unit (Panel/Communication)	Default setting	Write during running *6	User setting	Reference
F256	0256	Run sleep detection time	0.0: Disabled 0.1 - 600.0	s		0.0	Y		[6. 9]
F257	0257	Parameter for manufacturer	-	-	-	-	-		-
F258	0258	Parameter for manufacturer	-	-	-	-	-		-
F259	0259	Run sleep detection time at startup	0.0: Disabled 0.1 - 600.0	s		0.0	Y		[6. 9]
F260	0260	Jog frequency	F240 - 20.0	Hz		5.0	Y		[6. 10]
F261	0261	Jog stop select	0: Deceleration stop 1: Coast stop 2: DC braking stop	-	-	0	N		
F262	0262	Panel jog run	0: Disabled 1: Enabled	-	-	0	Y		
F264	0264	Terminal Up response time	0.0 - 10.0	s		0.1	Y		[6. 6. 5]
F265	0265	Terminal Up frequency step	0.0 - FH	Hz		0.1	Y		
F266	0266	Terminal Down response time	0.0 - 10.0	s		0.1	Y		
F267	0267	Terminal Down frequency step	0.0 - FH	Hz		0.1	Y		
F268	0268	Initial Up/Down frequency	LL - UL	Hz		0.0	Y		
F269	0269	Up/Down frequency rewrite	0: F268 is not changed. 1: F268 is changed after power off.	-	-	1	Y		
F270	0270	Jump frequency 1	0.0 - FH	Hz		0.0	Y		[6. 11]
F271	0271	Jump frequency 1 band	0.0 - 30.0	Hz		0.0	Y		
F272	0272	Jump frequency 2	0.0 - FH	Hz		0.0	Y		
F273	0273	Jump frequency 2 band	0.0 - 30.0	Hz		0.0	Y		
F274	0274	Jump frequency 3	0.0 - FH	Hz		0.0	Y		
F275	0275	Jump frequency 3 band	0.0 - 30.0	Hz		0.0	Y		
F287	0287	Preset speed 8	LL - UL	Hz		0.0	Y		[5. 3. 7] [6. 28]
F288	0288	Preset speed 9	LL - UL	Hz		0.0	Y		
F289	0289	Preset speed 10	LL - UL	Hz		0.0	Y		
F290	0290	Preset speed 11	LL - UL	Hz		0.0	Y		
F291	0291	Preset speed 12	LL - UL	Hz		0.0	Y		
F292	0292	Preset speed 13	LL - UL	Hz		0.0	Y		
F293	0293	Preset speed 14	LL - UL	Hz		0.0	Y		
F294	0294	Preset speed 15 / Forced run speed	LL - UL	Hz		0.0	Y		[5. 3. 7] [6. 12. 2] [6. 28] [6. 31]

Title	Communication No.	Parameter name	Adjustment range	Unit	Minimum setting unit (Panel/Communication)	Default setting	Write during running *6	User setting	Reference
F295	0295	Bumpless	0: Disabled 1: Enabled	-	-	0	Y		[6. 13]
F297	0297	Parameter for manufacturer	-	-	-	-	-		-
F298	0298	Parameter for manufacturer	-	-	-	-	-		-
F300	0300	Carrier frequency	Depending on capacity *1	kHz		*1	Y		[2. 4. 1] [2. 4. 3] [6. 14]
F301	0301	Auto-restart	0: Disabled 1: Power failure 2: Terminal ST On/Off 3: Terminal ST On/Off or power failure 4: At startup	-	-	0	N		[5. 4. 2]
F302	0302	Regenerative power ride-through	0: Disabled 1: Regenerative power ride-through 2: Deceleration stop at power failure 3: Synchronized Acc/Dec (TB) 4: Synchronized Acc/Dec (TB + power failure)	-	-	0	N		[6. 15. 2]
F303	0303	Retry	0: Disabled 1 - 10	Times		0	Y		[6. 15. 3]
F304	0304	Dynamic braking, OLR trip	0: Disabled 1: Enabled, OLR trip 2: Enabled, No OLR trip 3: Enabled (except during ST OFF), OLR trip 4: Enabled (except during ST OFF), No OLR trip 5: Enabled (except during trip), OLR trip 6: Enabled (except during trip), No OLR trip 7: Enabled (except during trip & ST OFF), OLR trip 8: Enabled (except during trip & ST OFF), No OLR trip	-	-	0	N		[6. 15. 4]
F305	0305	Overvoltage limit operation	0: Enabled 1: Disabled 2: Enabled (quick deceleration) 3: Enabled (dynamic quick deceleration)	-	-	2	N		[6. 15. 5]
F306	0306	Parameter for manufacturer	-	-	-	-	-		-

Title	Communication No.	Parameter name	Adjustment range	Unit	Minimum setting unit (Panel/Communication)	Default setting	Write during running *6	User setting	Reference
F307	0307	Supply voltage compensation, Output voltage limitation	0: Without supply voltage compensation, Limited output voltage 1: With supply voltage compensation, Limited output voltage 2: Without supply voltage compensation, Unlimited output voltage 3: With supply voltage compensation, Unlimited output voltage	-	-	*2	N		[6. 15. 6]
F308	0308	Braking resistance	0.5 - 1000	Ω		*1	N		[6. 15. 4]
F309	0309	Braking resistor capacity	0.01 - 600.0	kW		*1	N		
F310	0310	Dec time at power failure	0.0 - 320.0	s		2.0	N		[6. 15. 2]
F311	0311	Reverse inhibited	0: Allowed 1: Rev inhibited 2: Fwd inhibited 3: - 4: -	-	-	0	N		[6. 15. 7]
F312	0312	Random switching	0: Disabled 1: Random switching 1 2: Random switching 2 3: Random switching 3	-	-	0	N		[6. 14]
F313	0313	Ridethrough time	0.0: Continuous 0.1 - 320.0	s		2.0	N		[6. 15. 2]
F314	0314	Parameter for manufacturer	-	-	-	-	-		-
F315	0315	Parameter for manufacturer	-	-	-	-	-		-
F316	0316	Carrier frequency control	0: No decrease 1: Valid decrease 2: No decrease, 480V class 3: Valid decrease, 480V class 4: No decrease with sinusoidal filter 5: Valid decrease with sinusoidal filter	-	-	*1	N		[2. 4. 1] [6. 14]
F317	0317	Synchronized stop time	0.0 - 6000	s		2.0	Y		[6. 15. 2]
F318	0318	Synchronized reach time	0.0 - 6000	s		2.0	Y		
F319	0319	Regenerative over-flux upper limit	100 - 160	%		*2	N		[6. 15. 5]

Title	Communication No.	Parameter name	Adjustment range	Unit	Minimum setting unit (Panel/Communication)	Default setting	Write during running *6	User setting	Reference
F320	0320	Droop gain	0.0 - 100.0	%		0.0	Y		[6. 16]
F321	0321	Frequency at 0% droop gain	0.0 - 320.0	Hz		0.0	Y		
F322	0322	Frequency at F320 droop gain	0.0 - 320.0	Hz		0.0	Y		
F323	0323	Droop deadband torque	0 - 100	%		10	Y		
F324	0324	Droop output filter	0.1 - 200.0	rad/s		100.0	Y		
F325	0325	Brake release wait time	0.00 - 2.50	s		0.00	N		[6. 18. 1]
F326	0326	Brake release undercurrent threshold	0 - 100	% (A)		0	Y		
F327	0327	Parameter for manufacturer	-	-	-	-	-	-	-
F328	0328	Light-load high-speed operation	0: Disabled 1: Auto speed (Fwd: up) 2: Auto speed (Rev: up) 3: Speed F330 (Fwd: up) 4: Speed F330 (Rev: up)	-	-	0	N		[6. 17]
F329	0329	Light-load high-speed learning function	0: - 1: Fwd run only 2: Rev run only	-	-	0	N		
F330	0330	Light-load high-speed automatic operation frequency	30.0 - UL	Hz		50.0/ 60.0*2	N		
F331	0331	Light-load high-speed operation switching lower-limit frequency	5.0 - UL	HZ		40.0	Y		
F332	0332	Light-load high-speed operation load detection wait time	0.0 - 10.0	s		0.5	Y		
F333	0333	Light-load high-speed operation load detection time	0.0 - 10.0	s		1.0	Y		
F334	0334	Light-load high-speed operation heavy load detection time	0.0 - 10.0	s		0.5	Y		
F335	0335	Switching load torque during power running	-250 to +250	%		50	Y		
F336	0336	Heavy-load torque during power running	-250 to +250	%		100	Y		
F337	0337	Heavy-load torque during constant speed power running	-250 to +250	%		50	Y		
F338	0338	Switching load torque during regen	-250 to +250	%		50	Y		

Title	Communication No.	Parameter name	Adjustment range	Unit	Minimum setting unit (Panel/Communication)	Default setting	Write during running *6	User setting	Reference
F339	0339	Parameter for manufacturer	-	-	-	-	-		-
F340	0340	Creep time 1	0.00 - 10.00	s		0.00	N		[6. 18. 1]
F341	0341	Brake function	0: Disabled 1: Fwd hoisting 2: Rev hoisting 3: Horizontal operation	-	-	0	N		
F342	0342	Load torque input select	0: - 1: Terminal RR 2: Terminal RX 3: Terminal II 4: Terminal AI4 (option) 5 - 11: - 12: F343 13 - 19: - 20: Embedded Ethernet 21: RS485 communication (connector 1) 22: RS485 communication (connector 2) 23: Communication option	-	-	12	Y		[6. 18. 1]
F343	0343	Hoisting torque bias	-250 to +250 (F342 = "12" only)	%		100	Y		
F344	0344	Lowering torque bias rate	0 - 100	%		100	Y		
F345	0345	Brake releasing time	0.00 - 10.00	s		0.05	Y		
F346	0346	Creep frequency	F240 - 20.0	Hz		3.0	N		
F347	0347	Creep time 2	0.00 - 10.00	s		0.10	Y		
F348	0348	Brake learning	0: - 1: Enabled (0 after execution)	-	-	0	N		
F349	0349	Dwell operation	0: Disabled 1: F350-F353 setting 2: Terminal input	-	-	0	N		[6. 19]
F350	0350	Acc suspended frequency	0.0 - FH	Hz		0.0	Y		
F351	0351	Acc suspended time	0.0 - 10.0	s		0.0	Y		
F352	0352	Dec suspended frequency	0.0 - FH	Hz		0.0	Y		
F353	0353	Dec suspended time	0.0 - 10.0	s		0.0	Y		

Title	Communication No.	Parameter name	Adjustment range	Unit	Minimum setting unit (Panel/Communication)	Default setting	Write during running *6	User setting	Reference
F354	0354	Commercial power/ Inverter switching	0: Disabled 1: Switch at trip 2: Switch at F355 3: Switch at trip and at F355	-	-	0	N		[6. 20]
F355	0355	Commercial power switching frequency	0.0 - UL	Hz		50.0/ 60.0*2	Y		
F356	0356	Inverter switching wait time	0.10 - 10.00	s		*1	Y		
F357	0357	Commercial power switching wait time	0.10 - 10.00	s		0.62	Y		
F358	0358	Commercial power switching frequency continuous time	0.10 - 10.00	s		2.00	Y		
F359	0359	PID control1	0: Disabled 1: Process PID control 2: Speed PID control 3: Easy positioning PID control 4: Dancer control 5 - 10: - 11: Minus Process PID control 12: Minus Speed PID control 13: Minus Easy positioning PID control 14: Minus Dancer control	-	-	0	N		[5. 3. 8] [6. 21] [6. 22]
F360	0360	PID1 feedback input select	0: - 1: Terminal RR 2: Terminal RX 3: Terminal II 4: Terminal AI4 (option) 5: Terminal AI5 (option) 6 - 16: - 17: High resolution pulse train (option)	-	-	0	N		[5. 3. 8]
F361	0361	PID1 filter	0.0 - 25.0	s		0.0	Y		[6. 21]
F362	0362	PID1 proportional gain	0.01 - 100.0	-		0.30	Y		[5. 3. 8] [6. 21] [6. 22]
F363	0363	PID1 integral gain	0.01 - 100.0	s <sup>-1</sup>		0.20	Y		[5. 3. 8] [6. 21]
F364	0364	PID1 deviation upper-limit	LL - UL	Hz		50.0/ 60.0*2	Y		[6. 21]
F365	0365	PID1 deviation lower-limit	LL - UL	Hz		50.0/ 60.0*2	Y		
F366	0366	PID1 differential gain	0.00 - 2.55	s		0.00	Y		[5. 3. 8] [6. 21]
F367	0367	PID1 set value upper-limit	0.0 - FH	Hz		50.0/ 60.0*2	Y		
F368	0368	PID1 set value lower-limit	0.0 - F367	Hz		0.0	Y		



Title	Communication No.	Parameter name	Adjustment range	Unit	Minimum setting unit (Panel/Communication)	Default setting	Write during running *6	User setting	Reference
F369	0369	PID control start wait time	0 - 2400	s		0	Y		[5. 3. 8] [6. 21] [6. 22]
F370	0370	PID1 output upper-limit	LL - UL	Hz		50.0/ 60.0*2	Y		[6. 21]
F371	0371	PID1 output lower-limit	LL - UL	Hz		0.0	Y		
F372	0372	PID1 set value increase time	0.1-600.0 (Speed PID)	s		10.0	Y		
F373	0373	PID1 set value decrease time	0.1-600.0 (Speed PID)	s		10.0	Y		

Title	Communication No.	Parameter name	Adjustment range	Unit	Minimum setting unit (Panel/Communication)	Default setting	Write during running *6	User setting	Reference
F374	0374	PID1 set value agreement detection band	0.0 - FH	Hz		2.5	Y		[6. 21]
F375	0375	PG pulses number	1 - 9999	pulse		1000	N		[6. 22]
F376	0376	PG select	0: PTI (Command) - PTI (FB) 1: PTI (Command) - Digital option (FB) 2 - 5: - 6: Digital option (Command) - Non FB 7 - 9: - 10: PTI (Command) - PTI (FB inversion) 11: PTI (Command) - Digital option (FB inversion) 12 - 15: - 16: Digital option (Command inversion) - Non FB	-	-	0	N		[6. 6. 4] [6. 22]
F377	0377	PG option disconnection detection	0: Disabled 1: Enabled	-	-	0	N		-
F378	0378	Pulse train input pulses number	1 - 9999	pps		1000	N		[6. 6. 4]
F379	0379	PG option voltage	0: 5V 1: 12V 2: 24V	-	-	0	N		-
F381	0381	Simple positioning completion range	1 - 4000	pulse		100	Y		[6. 22]
F382	0382	Hit and stop control	0: Disabled 1: Enabled 2: -	-	-	0	Y		[6. 18. 2]
F383	0383	Hit and stop frequency	0.1 - 30.0	Hz		5.0	Y		
F384	0384	Hit and stop torque limit	0 - 100	%		100	Y		-
F385	0385	Hit and stop detection time	0.0 - 25.0	s		0.3	Y		-
F386	0386	Hit and stop continuation torque limit	0 - 100	%		50	Y		-
F388	0388	PID1 output dead band	0 - 100	%		0	Y		[6. 21]

Title	Communication No.	Parameter name	Adjustment range	Unit	Minimum setting unit (Panel/Communication)	Default setting	Write during running *6	User setting	Reference
F389	0389	PID1 set value select	0: selected by FMOd/ F207 1: Terminal RR 2: Terminal RX 3: Terminal II 4: Terminal AI4 (option) 5: Terminal AI5 (option) 6 - 11: - 12: FPId 13,14: - 15: Terminal Up/Down frequency 16: Pulse train 17: High resolution pulse train (option) 18,19: - 20: Embedded Ethernet 21: RS485 communication (connector 1) 22: RS485 communication (connector 2) 23: Communication option	-	-	0	N		[5. 3. 8] [6. 21]
F390	0390	Parameter for manufacturer	-	-	-	-	-		-
F391	0391	Sleep detection hysteresis	0.0 - UL	Hz		0.0	Y		[6. 9]
F392	0392	Wakeup deviation	0.0 - UL	Hz		0.0	Y		
F393	0393	Wakeup feedback	0.0 - UL	Hz		0.2	Y		
F394	0394	Parameter for manufacturer	-	-	-	-	-		-
F395	0395	Parameter for manufacturer	-	-	-	-	-		-
F399	0399	Parameter for manufacturer	-	-	-	-	-		-
F400	0400	Offline auto-tuning	0: - 1: Reset motor parameters (0 after execution) 2: Auto-tuning at run command (0 after execution) 3: Auto-tuning at TB ON 4: Motor parameters auto calculation (0 after execution) 5: 4+2 (0 after execution) 6: Auto-tuning at run command during TB ON 7: Auto-tuning F402 only at run command during TB ON	-	-	0	N		[6. 23. 1] [6. 23. 2]
F401	0401	Slip frequency gain	0 - 250	%		70	Y		[6. 23. 1]

Title	Communication No.	Parameter name	Adjustment range	Unit	Minimum setting unit (Panel/Communication)	Default setting	Write during running *6	User setting	Reference
F402	0402	Automatic torque boost	0.1 - 30.00	%		*1	Y		[6. 23. 1] [6. 23. 2]
F403	0403	Online auto-tuning	0: Disabled 1: Self-cooling motor auto-tuning 2: Forced air-cooling motor auto-tuning	-	-	0	N		[6. 23. 1]
F405	0405	Motor rated capacity	0.10 - 315.0	kW		*1	N		[6. 23. 1] [6. 23. 2]
F412	0412	Leakage inductance	0.0 - 25.0	%		*1	N		[6. 23. 1]
F413	0413	Exciting current coefficient	100 - 150	%		100	N		
F414	0414	Stall prevention coefficient	10 - 250	-		100	N		-
F415	0415	Motor rated current	Depending on capacity *1	A		*1	N		[6. 23. 1] [6. 23. 2]
F416	0416	Motor no load current	10 - 90	%		*1	N		[6. 23. 1]
F417	0417	Motor rated speed	100 - 64000	min <sup>-1</sup>		*2	N		[6. 23. 1] [6. 23. 2]
F418	0418	Parameter for manufacturer	-	-	-	-	-		-
F419	0419	Parameter for manufacturer	-	-	-	-	-		-
F420	0420	Torque command select	0: - 1: Terminal RR 2: Terminal RX 3: Terminal II 4: Terminal AI4 (option) 5 - 11: - 12: F725 13 - 19: - 20: Embedded Ethernet 21: RS485 communication (connector 1) 22: RS485 communication (connector 2) 23: Communication option	-	-	2	Y		[6. 25. 1]
F421	0421	Torque command filter	0 - 1000	ms		0	Y		

Title	Communication No.	Parameter name	Adjustment range	Unit	Minimum setting unit (Panel/Communication)	Default setting	Write during running *6	User setting	Reference
F423	0423	Tension control torque bias input	0: - 1: Terminal RR 2: Terminal RX 3: Terminal II 4: Terminal AI4 (option) 5 - 11: - 12: F725 13 - 19: - 20: Embedded Ethernet 21: RS485 communication connector 1 22: RS485 communication connector 2 23: Communication option	-	-	0	Y		[6. 25. 3]
F424	0424	Load sharing gain input	0: - 1: Terminal RR 2: Terminal RX 3: Terminal II 4: Terminal AI4 (option) 5 - 11: - 12: F725 13 - 19: - 20: Embedded Ethernet 21: RS485 communication connector 1 22: RS485 communication connector 2 23: Communication option	-	-	0	Y		[6. 25. 3]

Title	Communication No.	Parameter name	Adjustment range	Unit	Minimum setting unit (Panel/Communication)	Default setting	Write during running *6	User setting	Reference
F425	0425	Fwd speed limit input	0: - 1: Terminal RR 2: Terminal RX 3: Terminal II 4: Terminal AI4 (option) 5 - 11: - 12: F426	-	-	0	Y		[6. 25. 2]
F426	0426	Fwd speed limit level	0.0 - UL	Hz		50.0/ 60.0*2	Y		
F427	0427	Rev speed limit input	0: - 1: Terminal RR 2: Terminal RX 3: Terminal II 4: Terminal AI4 (option) 5 - 11: - 12: F428	-	-	0	Y		
F428	0428	Rev speed limit level	0.0 - UL	Hz		50.0/ 60.0*2	Y		
F430	0430	Speed limit center value input select	0: - 1: Terminal RR 2: Terminal RX 3: Terminal II 4: Terminal AI4 (option) 5 - 11: - 12: F431	-	-	0	Y		
F431	0431	Speed limit center value	0.0 - FH	Hz		0.0	Y		
F432	0432	Speed limit band	0.0 - FH	Hz		0.0	Y		
F435	0435	Rotation direction limit during torque control	0: Fwd/Rev permit 1: Command direction permit	-	-	0	Y		[6. 25. 1]
F440	0440	Power running torque limit input select 1	0: - 1: Terminal RR 2: Terminal RX 3: Terminal II 4: Terminal AI4 (option) 5 - 11: - 12: F441	-	-	12	Y		[6. 24. 1]
F441	0441	Power running torque limit level 1	0.0-249.9 250.0: Disabled	%		250.0	Y		[6. 24. 1] [6. 24. 3]

Title	Communication No.	Parameter name	Adjustment range	Unit	Minimum setting unit (Panel/Communication)	Default setting	Write during running *6	User setting	Reference
F442	0442	Regenerative torque limit input select 1	0: - 1: Terminal RR 2: Terminal RX 3: Terminal II 4: Terminal AI4 (option) 5 - 11: - 12: F443	-	-	12	Y		[6. 24. 1]
F443	0443	Regenerative torque limit level 1	0.0-249.9 250.0: Disabled	%		250.0	Y		
F444	0444	Power running torque limit level 2	0.0-249.9 250.0: Disabled	%		250.0	Y		
F445	0445	Regenerative torque limit level 2	0.0-249.9 250.0: Disabled	%		250.0	Y		
F446	0446	Power running torque limit level 3	0.0-249.9 250.0: Disabled	%		250.0	Y		
F447	0447	Regenerative torque limit level 3	0.0-249.9 250.0: Disabled	%		250.0	Y		
F448	0448	Power running torque limit level 4	0.0-249.9 250.0: Disabled	%		250.0	Y		
F449	0449	Regenerative torque limit level 4	0.0-249.9 250.0: Disabled	%		250.0	Y		
F451	0451	Acc/Dec operation after stall operation	0: Acc/Dec time 1: Minimum time	-	-	0	N		
F452	0452	Stall detection time during power running	0.00 - 10.00	s		0.00	Y		[6. 24. 3]
F453	0453	Stall operation during regen	0: Enabled 1: Disabled	-	-	0	Y		[6. 24. 4]
F454	0454	Torque limit in field weakening	0: Constant power limit 1: Constant torque limit	-	-	0	N		[6. 24. 1]
F455	0455	Torque command polarity at Rev	0: Regeneration at positive torque command 1: Power running at positive torque command	-	-	0	N		[6. 25. 1]
F456	0456	Exciting forcing level	20 - 150	%		*1	N		-
F457	0457	Exciting forcing control gain	5 - 75	Hz		50	N		-
F458	0458	Current control response	0 - 100	-		0	N		[6. 26. 1]

Title	Communication No.	Parameter name	Adjustment range	Unit	Minimum setting unit (Panel/Communication)	Default setting	Write during running *6	User setting	Reference
F459	0459	Load inertia ratio	0.1 - 100.0	Times		1.0	Y		
F460	0460	Speed control response 1	0.0 - 25.0	-		0.0	Y		
F461	0461	Speed control stabilization coefficient 1	0.50 - 2.50	-		1.00	Y		
F462	0462	Speed reference filter coefficient 1	0 - 100	-		35	Y		
F463	0463	Speed control response 2	0.0 - 25.0	-		0.0	Y		[6. 23. 1] [6. 23. 2] [6. 26. 1]
F464	0464	Speed control stabilization coefficient 2	0.50 - 2.50	-		1.00	Y		
F465	0465	Speed reference filter coefficient 2	0 - 100	-		35	Y		
F466	0466	Speed control response switching frequency	0.0 - FH	Hz		0.0	Y		
F467	0467	Parameter for manufacturer	-	-	-	-	-		-
F468	0468	Parameter for manufacturer	-	-	-	-	-		-
F469	0469	Parameter for manufacturer	-	-	-	-	-		-
F470	0470	RR input bias	0 - 255	-	1/1	128	Y		
F471	0471	RR input gain	0 - 255	-	1/1	128	Y		
F472	0472	RX input bias	0 - 255	-	1/1	128	Y		
F473	0473	RX input gain	0 - 255	-	1/1	128	Y		
F474	0474	II input bias	0 - 255	-	1/1	128	Y		
F475	0475	II input gain	0 - 255	-	1/1	128	Y		[6. 6. 3]
F476	0476	AI4 input bias	0 - 255	-	1/1	128	Y		
F477	0477	AI4 input gain	0 - 255	-	1/1	128	Y		
F478	0478	AI5 input bias	0 - 255	-	1/1	128	Y		
F479	0479	AI5 input gain	0 - 255	-	1/1	128	Y		
F480	0480	Inertia auto-tuning	0 - 1	-		0	N		-
F481	0481	Speed command at inertia auto-tuning	10 - 100	%		25	N		-
F482	0482	Speed variation width at inertia auto-tuning	0.1 - 25.0	%		5.0	N		-
F483	0483	Number of speed variation at inertia auto-tuning	5 - 50	Times		10	N		-
F490	0490	Parameter for manufacturer	-	-	-	-	-		-
F491	0491	Parameter for manufacturer	-	-	-	-	-		-



Title	Communication No.	Parameter name	Adjustment range	Unit	Minimum setting unit (Panel/Communication)	Default setting	Write during running *6	User setting	Reference	
F495	0495	Over modulation ratio	90 - 120	%		104	N		[6. 26. 2]	
F498	0498	Parameter for manufacturer	-	-	-	-	-		-	
F499	0499	Parameter for manufacturer	-	-	-	-	-		-	
F500	0500	Acceleration time 2	0.0 - 6000 (600.0)	s		*1	Y		[6. 27. 2]	
F501	0501	Deceleration time 2	0.0 - 6000 (600.0)	s		*1	Y			
F502	0502	Acc/Dec pattern 1	0: Linear 1: S-Pattern 1 2: S-Pattern 2	-	-	0	Y		[6. 27. 1] [6. 27. 2]	
F503	0503	Acc/Dec pattern 2	0: Linear 1: S-Pattern 1 2: S-Pattern 2	-	-	0	Y		[6. 27. 2]	
F504	0504	Panel Acc/Dec select	1: Acc/Dec 1 2: Acc/Dec 2 3: Acc/Dec 3 4: Acc/Dec 4	-	-	1	Y			
F505	0505	Acc/Dec switching frequency 1	0.0: Disabled 0.1 - UL	Hz		0.0	Y			
F506	0506	S-Pattern range at Acc start	0 - 50	%		10	Y			
F507	0507	S-Pattern range at Acc completion	0 - 50	%		10	Y		[6. 27. 1] [6. 27. 2]	
F508	0508	S-Pattern range at Dec completion	0 - 50	%		10	Y			
F509	0509	S-Pattern range at Dec start	0 - 50	%		10	Y			
F510	0510	Acceleration time 3	0.0 - 6000 (600.0)	s		*1	Y		[6. 27. 2]	
F511	0511	Deceleration time 3	0.0 - 6000 (600.0)	s		*1	Y			
F512	0512	Acc/Dec pattern 3	0: Linear 1: S-Pattern 1 2: S-Pattern 2	-	-	0	Y			
F513	0513	Acc/Dec switching frequency 2	0.0: Disabled 0.1 - UL	Hz		0.0	Y			
F514	0514	Acceleration time 4	0.0 - 6000 (600.0)	s		*1	Y			
F515	0515	Deceleration time 4	0.0 - 6000 (600.0)	s		*1	Y			
F516	0516	Acc/Dec pattern 4	0: Linear 1: S-Pattern 1 2: S-Pattern 2	-	-	0	Y			
F517	0517	Acc/Dec switching frequency 3	0.0: Disabled 0.1 - UL	Hz		0.0	Y			
F519	0519	Unit of Acc/Dec time	0: - 1: 0.01 s unit (0 after execution) 2: 0.1 s unit (0 after execution)	-	-	0	N			[5. 2. 4] [6. 27. 2]

Title	Communication No.	Parameter name	Adjustment range	Unit	Minimum setting unit (Panel/Communication)	Default setting	Write during running *6	User setting	Reference
F520	0520	Pattern operation	0: Disabled 1: Enabled (seconds) 2: Enabled (minutes)	-	-	0	N		[6. 28]
F521	0521	Pattern operation continue select	0: Reset after stop 1: Continue after stop	-	-	0	N		
F522	0522	Pattern 1 repeat number	1 - 254 255: Continuous	Times	1/1	1	N		

Title	Communication No.	Parameter name	Adjustment range	Unit	Minimum setting unit (Panel/Communication)	Default setting	Write during running *6	User setting	Reference
F523	0523	Pattern 1 select 1	0: Skip	-	-	0	N		[6. 28]
F524	0524	Pattern 1 select 2	1: Sr1	-	-	0	N		
F525	0525	Pattern 1 select 3	2: Sr2	-	-	0	N		
F526	0526	Pattern 1 select 4	3: Sr3	-	-	0	N		
F527	0527	Pattern 1 select 5	4: Sr4	-	-	0	N		
F528	0528	Pattern 1 select 6	5: Sr5	-	-	0	N		
F529	0529	Pattern 1 select 7	6: Sr6	-	-	0	N		
F530	0530	Pattern 1 select 8	7: Sr7	-	-	0	N		
F531	0531	Pattern 2 repeat number	8: F287	Times		1	N		
F532	0532	Pattern 2 select 1	9: F288	-	-	0	N		
F533	0533	Pattern 2 select 2	10: F289	-	-	0	N		
F534	0534	Pattern 2 select 3	11: F290	-	-	0	N		
F535	0535	Pattern 2 select 4	12: F291	-	-	0	N		
F536	0536	Pattern 2 select 5	13: F292	-	-	0	N		
F537	0537	Pattern 2 select 6	14: F293	-	-	0	N		
F538	0538	Pattern 2 select 7	15: F294	-	-	0	N		
F539	0539	Pattern 2 select 8		-	-	0	N		
F540	0540	Operation time (1-speed)		s/min	0.1/0.1	5.0	Y		
F541	0541	Operation time (2-speed)		s/min	0.1/0.1	5.0	Y		
F542	0542	Operation time (3-speed)		s/min	0.1/0.1	5.0	Y		
F543	0543	Operation time (4-speed)		s/min	0.1/0.1	5.0	Y		
F544	0544	Operation time (5-speed)		s/min	0.1/0.1	5.0	Y		
F545	0545	Operation time (6-speed)	0.1 - 5999 (Unit by F520)	s/min	0.1/0.1	5.0	Y		
F546	0546	Operation time (7-speed)	6000: Continuous	s/min	0.1/0.1	5.0	Y		
F547	0547	Operation time (8-speed)		s/min	0.1/0.1	5.0	Y		
F548	0548	Operation time (9-speed)		s/min	0.1/0.1	5.0	Y		
F549	0549	Operation time (10-speed)		s/min	0.1/0.1	5.0	Y		
F550	0550	Operation time (11-speed)		s/min	0.1/0.1	5.0	Y		

Title	Communication No.	Parameter name	Adjustment range	Unit	Minimum setting unit (Panel/Communication)	Default setting	Write during running *6	User setting	Reference
F551	0551	Operation time (12-speed)	0.1 - 5999 (Unit by F520) 6000: Continuous	s/min	0.1/0.1	5.0	Y		[6. 28]
F552	0552	Operation time (13-speed)		s/min	0.1/0.1	5.0	Y		
F553	0553	Operation time (14-speed)		s/min	0.1/0.1	5.0	Y		
F554	0554	Operation time (15-speed)		s/min	0.1/0.1	5.0	Y		
F560	0560	Preset speed operation style	0: Frequency only 1: With function	-	-	0	N		[5. 3. 7] [6. 12. 1]
F561	0561	Operation function (1-speed)	0: Fwd run +1: Rev run +2: Acc/Dec switching signal 1 +4: Acc/Dec switching signal 2 +8: V/f switching signal 1 +16: V/f switching signal 2 +32: Torque limit switching signal 1 +64: Torque limit switching signal 2	-	1/1	0	N		[5. 3. 7] [6. 12. 1] [6. 28]
F562	0562	Operation function (2-speed)		-	1/1	0	N		
F563	0563	Operation function (3-speed)		-	1/1	0	N		
F564	0564	Operation function (4-speed)		-	1/1	0	N		
F565	0565	Operation function (5-speed)		-	1/1	0	N		
F566	0566	Operation function (6-speed)		-	1/1	0	N		
F567	0567	Operation function (7-speed)		-	1/1	0	N		
F568	0568	Operation function (8-speed)		-	1/1	0	N		
F569	0569	Operation function (9-speed)		-	1/1	0	N		
F570	0570	Operation function (10-speed)		-	1/1	0	N		
F571	0571	Operation function (11-speed)		-	1/1	0	N		
F572	0572	Operation function (12-speed)		-	1/1	0	N		
F573	0573	Operation function (13-speed)		-	1/1	0	N		
F574	0574	Operation function (14-speed)		-	1/1	0	N		
F575	0575	Operation function (15-speed)		-	1/1	0	N		
F576	0576	Operation function (0-speed)		-	1/1	0	N		
F590	0590	Shock monitoring	0: Disabled 1: Current detection 2: Torque detection 3: -	-	-	0	N		[6. 29]
F591	0591	Shock monitoring trip	0: Disabled 1: Enabled	-	-	0	Y		

Title	Communication No.	Parameter name	Adjustment range	Unit	Minimum setting unit (Panel/Communication)	Default setting	Write during running *6	User setting	Reference
F592	0592	Shock monitoring detection	0: Overcurrent/ Overtorque detection 1: Undercurrent/ Undertorque detection	-	-	0	Y		[6. 29]
F593	0593	Shock monitoring detection level	0 - 250	%		150	Y		
F595	0595	Shock monitoring detection time	0.0 - 10.0	s		0.5	Y		
F596	0596	Shock monitoring detection hysteresis	0 - 100	%		10	Y		
F597	0597	Shock monitoring detection wait time	0.0 - 300.0	s		0.0	Y		
F598	0598	Shock monitoring detection condition	0: During run 1: During run (except Acc/Dec)	-	-	0	Y		
F600	0600	Parameter for manufacturer	-	-	-	-	-		-
F601	0601	Stall prevention level 1	10 - 200 (HD) 10 - 160 (ND)	%		150 (HD) 120 (ND)	Y		[6. 24. 3] [6. 30. 2]
F602	0602	Trip record retention	0: Clear at power off 1: Retain at power off	-	-	0	Y		[6. 30. 3]
F603	0603	Emergency off stop pattern	0: Trip 1: Trip after Deceleration stop 2: Trip after Emergency DC braking 3: Trip after deceleration stop by F515 4: Trip after Quick deceleration stop 5: Trip after Dynamic quick deceleration stop	-	-	0	N		[6. 30. 4]
F604	0604	Emergency DC braking time	0.0 - 20.0	s		1.0	Y		
F605	0605	Output phase loss detection	0: Disabled 1: At startup (only one time after power on) 2: At every startup 3: During run 4: At every startup + during run 5: Output shut off detection	-	-	0	N		[6. 30. 5]
F606	0606	Motor overload reduction frequency threshold	0.0 - 60.0	Hz		6.0	Y		[5. 2. 5] [6. 30. 1]
F607	0607	Motor overload time	10 - 2400	s		300	Y		
F608	0608	Input phase loss trip	0: Disabled 1: Enabled	-	-	1	N		[6. 30. 6]

Title	Communication No.	Parameter name	Adjustment range	Unit	Minimum setting unit (Panel/Communication)	Default setting	Write during running *6	User setting	Reference
F609	0609	Undercurrent detection hysteresis	1 - 20	%		10	Y		[6. 30. 7]
F610	0610	Undercurrent trip	0: Disabled 1: Enabled	-	-	0	Y		
F611	0611	Undercurrent detection level	0 - 150	%		0	Y		
F612	0612	Undercurrent detection time	0 - 255	s		0	Y		
F613	0613	Short circuit detection at start	0: At every startup by standard pulse 1: Only one time after power on by standard pulse 2: At every startup by F614 setting pulse 3: Only one time after power on by F614 setting pulse	-	-	0	N		[6. 30. 9]
F614	0614	Pulse width of short circuit detection at start	0: No short circuit detection at start 1 - 50	μs		25	N		
F615	0615	Overtorque trip	0: Disabled 1: Enabled	-	-	0	Y		[6. 30. 8]
F616	0616	Overtorque detection level during power running	0: Disabled 1 - 320	%		150	Y		
F617	0617	Overtorque detection level during regen	0: Disabled 1 - 320	%		150	Y		
F618	0618	Overtorque detection time	0.0 - 10.0	s		0.5	Y		
F619	0619	Overtorque detection hysteresis	0 - 100	%		10	Y		
F620	0620	Cooling fan control	0: Auto ON/OFF, No failure detection 1: Always ON, No failure detection 2: Auto ON/OFF, Failure detection 3: Always ON, Failure detection 4 - 7: -	-	-	2	Y		[6. 30. 11]
F621	0621	Cumulative run time alarm	0.0 - 999.0	100 h		876.0	Y		[6. 30. 12]
F622	0622	Abnormal speed detection time	0.01 - 100.0	s		0.01	Y		[6. 30. 13]
F623	0623	Abnormal speed increase band	0.00: Disabled 0.01 - 30.0	Hz		0.00	Y		
F624	0624	Abnormal speed decrease band	0.00: Disabled 0.01 - 30.0	Hz		0.00	Y		
F625	0625	Undervoltage detection level	50 - 79 80: Auto	%		80	N		[6. 15. 2] [6. 30. 14]

Title	Communication No.	Parameter name	Adjustment range	Unit	Minimum setting unit (Panel/Communication)	Default setting	Write during running *6	User setting	Reference
F626	0626	Overvoltage limit operation level	100 - 150	%		134	N		[6. 15. 4] [6. 15. 5]
F627	0627	Undervoltage trip	0: Disabled 1: Enabled	-	-	0	N		[6. 30. 14]
F628	0628	Undervoltage detection time	0.01 - 10.00	s		0.03	N		
F629	0629	Regenerative power ride-through level	55 - 100	%		75	N		[6. 15. 2] [6. 30. 14]
F630	0630	Brake answer wait time	0.0: Disabled 0.1 - 10.0	s		0.0	Y		[6. 18. 1] [6. 30. 15]
F631	0631	Inverter overload detection	0: 150% - 60s (HD) 120% - 60s (ND) 1: Temperature estimation	-	-	0	N		[5. 3. 5] [6. 30. 1]
F632	0632	Motor overload memory target	0: No.1 to 4 motor, memory disabled 1: No.1 to 4 motor, memory enabled 2: No.1 motor, memory disabled 3: No.1 motor, memory enabled	-	-	0	Y		
F633	0633	II analog input disconnection detection level	0: Disabled 1 - 100	%		0	Y		[6. 30. 16]
F634	0634	Annual average ambient temperature	1: -15 to +10°C 2: +11 to +20°C 3: +21 to +30°C 4: +31 to +40°C 5: +41 to +50°C 6: +51 to +60°C	-	-	3	Y		[6. 30. 17]
F635	0635	Rush current suppression relay delay time	0.0 - 2.5	s		0.0	N		[6. 30. 18]
F636	0636	Ground fault trip	0: Disabled 1: Enabled	-	-	1	N		[6. 30. 10]
F637	0637	Terminal AI4 PTC trip	0: Disabled 1: Enabled	-	-	0	N		[6. 30. 19]
F638	0638	Terminal AI5 PTC trip	0: Disabled 1: Enabled	-	-	0	N		
F639	0639	Braking resistor overload time	0.1 - 600.0	s		5.0	N		[6. 15. 4]
F640	0640	DC supply input	0: Disabled 1: Enabled	-	-	0	N		-
F643	0643	Residual voltage waiting control frequency threshold	0.0 - 60.0	Hz		10.0	N		-
F644	0644	Operation after II analog input disconnection detection	1: Continue running 2: Deceleration stop 3: Coast stop 4: Trip 5: Run by F649	-	-	4	N		[6. 30. 16]

Title	Communication No.	Parameter name	Adjustment range	Unit	Minimum setting unit (Panel/Communication)	Default setting	Write during running *6	User setting	Reference
F645	0645	Terminal RR PTC trip	0: Disabled 1: Enabled	-	-	0	Y		[6. 30. 19]
F646	0646	PTC detection resistance	100 - 9999	Ω		3000	Y		
F647	0647	Control power option failure detection	0: Alarm (no detection without option) 1: Alarm 2: Trip	-	-	0	Y		[6. 30. 20]
F648	0648	Number of starting alarm	0.0 - 999.0	10000 times		999.0	Y		[6. 30. 21]
F649	0649	Fallback frequency	LL - UL	Hz		0.0	Y		[6. 30. 16]
F650	0650	Forced run	0: Disabled 1: Enabled	-	-	0	Y		[6. 31]
F651	0651	Undertorque trip	0: Disabled 1: Enabled	-	-	0	Y		-
F652	0652	Undertorque detection level during power running	0 - 250	%		0	Y		-
F653	0653	Undertorque detection level during regen	0 - 250	%		0	Y		-
F654	0654	Undertorque detection time	0.00 - 10.00	s		0.50	Y		-
F655	0655	Undertorque detection hysteresis	0 - 100	%		10	Y		-
F656	0656	PTC detection temperature	0 - 200	°C		90	Y		[6. 30. 19]
F657	0657	Overload alarm level	10 - 100	%		50	Y		[5. 2. 5] [6. 30. 1]
F658	0658	Number of external equipment starting alarm	0.0 - 999.0	10000 times		999.0	Y		[6. 30. 21]
F659	0659	Cumulative overcurrent level	10 - 200	%		100	Y		[6. 30. 22]



Title	Communication No.	Parameter name	Adjustment range	Unit	Minimum setting unit (Panel/Communication)	Default setting	Write during running *6	User setting	Reference
F660	0660	Override adding input select	0: - 1: Terminal RR 2: Terminal RX 3: Terminal II 4: Terminal AI4 (option) 5: Terminal AI5 (option) 6 - 9: - 10: Touch wheel 1 (power off or press OK to save) 11 - 14: - 15: Terminal Up/Down frequency 16: Pulse train 17: High resolution pulse train (option) 18,19: - 20: Embedded Ethernet 21: RS485 communication (connector 1) 22: RS485 communication (connector 2) 23: Communication option	-	-	0	Y		[6. 32]

Title	Communication No.	Parameter name	Adjustment range	Unit	Minimum setting unit (Panel/Communication)	Default setting	Write during running *6	User setting	Reference
F661	0661	Override multiplying input select	0: - 1: Terminal RR 2: Terminal RX 3: Terminal II 4: Terminal AI4 (option) 5 - 11: - 12: F729 13 - 23: -	-	-	0	Y		[6. 32]
F664	0664	Specified trip 1	0 - 100	Times	1/1	0	N		[6. 30. 21]
F665	0665	Specified trip 2	0 - 100	Times	1/1	0	N		
F666	0666	Specified trip 3	0 - 100	Times	1/1	0	N		
F667	0667	Pulse output step of input cumulative power	0: 0.1kWh 1: 1kWh 2: 10kWh 3: 100kWh 4: 1000kWh 5: 10000kWh	-	-	1	Y		[6. 33. 1]
F668	0668	Pulse output width of input cumulative power	0.1 - 1.0	s		0.1	Y		
F669	0669	Terminal FP switching	0: Digital output 1: Pulse output	-	-	0	N		[6. 33. 2] [7. 2. 2]
F670	0670	Terminal AM function	0 - 162 *3	-	-	2	Y		[5. 2. 6]
F671	0671	Terminal AM adjustment	-	-	-	-	Y		
F676	0676	Terminal FP pulse train output function	0 - 149 *3	-	-	0	Y		[6. 33. 2]
F677	0677	Maximum pulse number of pulse train output	0.50 - 43.20	kpps		8.00	Y		
F678	0678	Pulse train output filter	1 - 1000	ms		64	Y		
F679	0679	Pulse train input filter	1 - 1000	ms		1	Y		[6. 6. 4]
F681	0681	Terminal FM switching	0: Meter option (0-1mA) 1: Current output (0-20mA) 2: Voltage output (0-10V)	-	-	2	N		[6. 33. 3]
F682	0682	Terminal FM inclination polarity	0: Negative inclination (downward slope) 1: Positive inclination (upward slope)	-	-	1	Y		

Title	Communication No.	Parameter name	Adjustment range	Unit	Minimum setting unit (Panel/Communication)	Default setting	Write during running *6	User setting	Reference
F683	0683	Terminal FM bias	-100.0 to +100.0	%		0.0	Y		[6. 33. 3]
F684	0684	Terminal FM filter	1 - 1000	ms		1	Y		
F685	0685	Terminal FM upper-limit level	0.0 - 100.0	%		100.0	Y		
F686	0686	Terminal AM switching	0: Meter option (0-1mA) 1: Current output (0-20mA) 2: Voltage output (0-10V)	-	-	2	N		
F687	0687	Terminal AM inclination polarity	0: Negative inclination (downward slope) 1: Positive inclination (upward slope)	-	-	1	Y		
F688	0688	Terminal AM bias	-100.0 to +100.0	%		0.0	Y		
F689	0689	Terminal AM filter	1 - 1000	ms		1	Y		
F690	0690	Terminal AM upper-limit level	0.0 - 100.0	%		100.0	Y		
F699	0699	Trip for test	0 - 100			0	Y	-	
F700	0700	Parameter reading & writing access lockout	0: Unlocked 1: Writing locked (Operation panel, Extension panel) 2: Writing locked (1+RS485) 3: Reading & Writing locked (Operation panel, Extension panel) 4: Reading & Writing locked (3+RS485)	-	-	0	Y		[6. 34. 1]
F701	0701	Current, voltage units select	0: % 1: A (ampere), V (volt)	-	-	0	Y		[5. 2. 7] [6. 34. 2]
F702	0702	Free unit multiplicaton factor	0.00: Disabled 0.01 - 200.0	Times		0.00	Y		[5. 4. 3] [6. 34. 3]
F703	0703	Target of free unit	0: All frequencies 1: PID frequencies	-	-	0	Y		
F704	0704	Reference Website	0: English (USA website) 1: English (Japan website)	-	-	*2	Y		
F705	0705	Free unit inclination polarity	0: Negative inclination (downward slope) 1: Positive inclination (upward slope)	-	-	1	Y		
F706	0706	Free unit bias	0.00 - FH	Hz		0.00	Y		
F707	0707	Step of panel setting	0.00: Disabled 0.01 - FH	Hz		0.00	Y		[6. 34. 4]
F708	0708	Step of panel display	0: Disabled 1 - 255	-	-	0	Y		
F709	0709	Hold function of standard mode	0: Real time 1: Peak hold 2: Minimum hold	-	-	0	Y		[6. 34. 7]

Title	Communication No.	Parameter name	Adjustment range	Unit	Minimum setting unit (Panel/Communication)	Default setting	Write during running *6	User setting	Reference
F710	0710	Standard mode display	0 - 162 *3	-	-	0	Y		[4. 2. 3] [5. 4. 3] [6. 34. 5]
F711	0711	Monitor mode 1 display		-	-	2	Y		[6. 34. 6] [8. 1. 1]
F712	0712	Monitor mode 2 display		-	-	3	Y		
F713	0713	Monitor mode 3 display		-	-	4	Y		
F714	0714	Monitor mode 4 display		-	-	8	Y		
F715	0715	Monitor mode 5 display		-	-	18	Y		
F716	0716	Monitor mode 6 display		-	-	19	Y		
F717	0717	Monitor mode 7 display		-	-	35	Y		
F718	0718	Monitor mode 8 display		-	-	34	Y		
F719	0719	Run command clear select	0: Clear at coast stop. Retain at MOFF and when CMOD is changed. 1: Retain run command. 2: Clear at coast stop and at MOFF. Retain when CMOD is changed. 3: Clear at coast stop, at MOFF and when CMOD is changed.	-	-	2	Y		[6. 34. 8]
F720	0720	Standard mode display of extension panel	0 - 162 *4	-	-	0	Y		[5. 4. 3] [6. 34. 5]
F721	0721	Panel stop	0: Deceleration stop 1: Coast stop	-	-	0	Y		[6. 34. 9]
F722	0722	Monitor mode filter	8 - 1000	ms		200	Y		-
F723	0723	Status area display of operation panel	0 - 162 *4	-	-	1	Y		[5. 4. 3] [6. 34. 5]
F724	0724	Frequency setting target by touch wheel	0: Panel run frequency command (FC) 1: FC + Preset speed	-	-	0	Y		[5. 3. 7]
F725	0725	Panel torque command	-250 to +250	%		0	Y		[6. 25. 1] [6. 34. 10]
F727	0727	Panel tension torque bias	-250 to +250	%		0	Y		[6. 25. 3]
F728	0728	Panel load sharing gain	0 - 250	%		100	Y		
F729	0729	Panel override multiplication gain	-100 to +100	%		0	Y		[6. 32]

Title	Communication No.	Parameter name	Adjustment range	Unit	Minimum setting unit (Panel/Communication)	Default setting	Write during running *6	User setting	Reference
F730	0730	Panel frequency setting lockout	0: Unlocked without press OK 1: Locked 2: Unlocked after press OK	-	-	2	Y		[6. 34. 1]
F731	0731	Operation after disconnection detection during panel run	1: Continue running 2 - 3: - 4: Trip	-	-	4	Y		
F732	0732	Panel Hand/Auto function lockout	0: Unlocked 1: Locked	-	-	1	Y		
F733	0733	Panel Run lockout	0: Unlocked 1: Locked	-	-	0	Y		
F734	0734	Panel emergency off lockout	0: Unlocked 1: Locked	-	-	0	Y		
F735	0735	Panel reset lockout	0: Unlocked 1: Locked	-	-	0	Y		
F736	0736	CMO <sub>d</sub> /FMO <sub>d</sub> change lockout during run	0: Unlocked 1: Locked	-	-	1	Y		
F737	0737	Panel keys lockout	0: Unlocked 1: Locked 2: Locked only extension panel 3: Locked only operation panel	-	-	0	Y		
F738	0738	Password setting	0: Disabled 1 - 9998 9999: Password was set	-	-	0	Y		
F739	0739	Password verification	0: non-setting 1 - 9998 9999: Password was set	-	-	0	Y		
F740	0740	Trace	0: Disabled 1: At trip 2: At trigger input 3: At trip & at trigger input	-	-	1	Y		[6. 35]
F741	0741	Trace cycle	0: 4ms 1: 20ms 2: 100ms 3: 1s 4: 10s	-	-	2	Y		
F742	0742	Trace data 1	0 - 162 *3	-	-	0	Y		
F743	0743	Trace data 2		-	-	1	Y		
F744	0744	Trace data 3		-	-	2	Y		
F745	0745	Trace data 4		-	-	3	Y		
F748	0748	Cumulative power save	0: Disabled 1: Enabled	-	-	0	Y		[6. 36]
F749	0749	Cumulative power unit	0: 1.0=1 kWh 1: 1.0=10 kWh 2: 1.0=100 kWh 3: 1.0=1000 kWh 4: 1.0=10000 kWh 5: 1.0=100000 kWh	-	-	*1	Y		

Title	Communication No.	Parameter name	Adjustment range	Unit	Minimum setting unit (Panel/Communication)	Default setting	Write during running *6	User setting	Reference
F750	0750	EASY key function	0: Easy/Setting mode switching 1: Shortcut function (Extension panel only) 2: Hand/Auto switching 3: Monitor peak and minimum hold trigger	-	-	0	N		[6. 37]
F751	0751	Easy setting 1	0-2999 Set easy setting parameters by the communication number 0000-0998: Basic, F100-F998 1000-1999: A000-A999 2000-2999: C000-C999	-	-	3	Y		[5. 2. 8]
F752	0752	Easy setting 2		-	-	4	Y		
F753	0753	Easy setting 3		-	-	9	Y		
F754	0754	Easy setting 4		-	-	10	Y		
F755	0755	Easy setting 5		-	-	12	Y		
F756	0756	Easy setting 6		-	-	13	Y		
F757	0757	Easy setting 7		-	-	31	Y		
F758	0758	Easy setting 8		-	-	6	Y		
F759	0759	Easy setting 9		-	-	999	Y		
F760	0760	Easy setting 10		-	-	999	Y		
F761	0761	Easy setting 11		-	-	999	Y		
F762	0762	Easy setting 12		-	-	999	Y		
F763	0763	Easy setting 13		-	-	999	Y		
F764	0764	Easy setting 14		-	-	999	Y		
F765	0765	Easy setting 15		-	-	999	Y		
F766	0766	Easy setting 16		-	-	999	Y		
F767	0767	Easy setting 17		-	-	999	Y		
F768	0768	Easy setting 18		-	-	999	Y		
F769	0769	Easy setting 19		-	-	999	Y		
F770	0770	Easy setting 20		-	-	999	Y		
F771	0771	Easy setting 21		-	-	999	Y		
F772	0772	Easy setting 22		-	-	999	Y		
F773	0773	Easy setting 23		-	-	999	Y		
F774	0774	Easy setting 24		-	-	999	Y		
F775	0775	Easy setting 25		-	-	999	Y		
F776	0776	Easy setting 26		-	-	999	Y		
F777	0777	Easy setting 27		-	-	999	Y		
F778	0778	Easy setting 28		-	-	999	Y		
F779	0779	Easy setting 29		-	-	999	Y		
F780	0780	Easy setting 30		-	-	999	Y		
F781	0781	Easy setting 31		-	-	701	Y		
F782	0782	Easy setting 32		-	-	50	Y		

Title	Communication No.	Parameter name	Adjustment range	Unit	Minimum setting unit (Panel/Communication)	Default setting	Write during running *6	User setting	Reference
F790	0790	Panel display at power on	0: HELLO (Depending on language setting) 1: F791 - F798 2, 3: -	-	-	0	Y		[6. 34. 11]
F791	0791	1st and 2nd characters of F790	0-FFFF	Hex	-	2d2d	Y		
F792	0792	3rd and 4th characters of F790	0-FFFF	Hex	-	2d2d	Y		
F793	0793	5th and 6th characters of F790	0-FFFF	Hex	-	2d2d	Y		
F794	0794	7th and 8th characters of F790	0-FFFF	Hex	-	2d2d	Y		
F795	0795	9th and 10th characters of F790	0-FFFF	Hex	-	2d2d	Y		
F796	0796	11th and 12th characters of F790	0-FFFF	Hex	-	2d2d	Y		
F797	0797	13th and 14th characters of F790	0-FFFF	Hex	-	2d2d	Y		
F798	0798	15th and 16th characters of F790	0-FFFF	Hex	-	2d2d	Y		
F799	0799	Parameter for manufacturer	-	-	-	-	-		

Title	Communication No.	Parameter name	Adjustment range	Unit	Minimum setting unit (Panel/Communication)	Default setting	Write during running *6	User setting	Reference
F800	0800	RS485 (1) baud rate	0: 9600 bps 1: 19200 bps 2: 38400 bps 3: -	-	-	1	Y		
F801	0801	RS485 (1) parity	0: Disabled 1: Even parity 2: Odd parity	-	-	1	Y		
F802	0802	Inverter number (RS485 common)	0 - 247	-	-	0	Y		
F803	0803	RS485 (1) time-out time	0.0: Disabled 0.1 - 100.0	s		0.0	Y		
F804	0804	RS485 (1) time-out operation	1: Continue running 2, 3: - 4: Trip 5: - 6: Trip after deceleration stop	-	-	1	Y		
F805	0805	RS485 (1) transmission wait time	0.00 - 2.00	s		0.00	Y		
F806	0806	RS485 (1) inverter to inverter communication	0: Follower (0Hz command when Leader fails) 1: Follower (continue running when Leader fails) 2: Follower (emergency off when Leader fails) 3: Leader (transmit frequency command) 4: Leader (transmit output frequency signal) 5: Leader (transmit torque command) 6: Leader (transmit output torque)	-	-	0	Y		[6. 38. 1]
F807	0807	RS485 (1) protocol	0: TOSHIBA 1: MODBUS	-	-	0	Y		
F808	0808	RS485 (1) time-out detection	0: Always 1: Run command and frequency command by communication are enabled. 2: During run by communication	-	-	1	Y		
F809	0809	Operation panel connection priority	0: By the parameter setting 1: Connect to connector 1 2: Connect to connector 2	-	-	1	Y		-



Title	Communication No.	Parameter name	Adjustment range	Unit	Minimum setting unit (Panel/Communication)	Default setting	Write during running *6	User setting	Reference
F810	0810	Communication frequency point select	0: Disabled 1: RS485 (1) 2: RS485 (2) 3: Communication option 4: Embedded Ethernet	-	-	0	Y		[6. 6. 2] [6. 38. 1]
F811	0811	Communication point 1 input value	0 - 100	%		0	Y		
F812	0812	Communication point 1 frequency	0.0 - FH	Hz		0.0	Y		
F813	0813	Communication point 2 input value	0 - 100	%		100	Y		
F814	0814	Communication point 2 frequency	0.0 - FH	Hz		50.0/ 60.0*2	Y		
F820	0820	RS485 (2) baud rate	0: 9600 bps 1: 19200 bps 2: 38400 bps 3: -	-	-	1	Y		[6. 38. 1]
F821	0821	RS485 (2) parity	0: Disabled 1: Even parity 2: Odd parity	-	-	1	Y		
F823	0823	RS485 (2) time-out time	0.0: Disabled 0.1 - 100.0	s		0.0	Y		
F824	0824	RS485 (2) time-out operation	1: Continue running 2, 3: - 4: Trip 5: - 6: Trip after deceleration stop	-	-	1	Y		
F825	0825	RS485 (2) transmission wait time	0.00 - 2.00	s		0.00	Y		
F826	0826	RS485 (2) inverter to inverter communication	0: Follower (0Hz command when Leader fails) 1: Follower (continue running when Leader fails) 2: Follower (emergency off when Leader fails) 3: Leader (transmit frequency command) 4: Leader (transmit output frequency signal) 5: Leader (transmit torque command) 6: Leader (transmit output torque command)	-	-	0	Y		
F827	0827	RS485 (2) protocol	0: TOSHIBA 1: MODBUS	-	-	0	Y		

Title	Communication No.	Parameter name	Adjustment range	Unit	Minimum setting unit (Panel/Communication)	Default setting	Write during running *6	User setting	Reference
F828	0828	RS485 (2) time-out detection	0: Always 1: Run command and frequency command by communication are enabled. 2: During run by communication	-	-	1	Y		[6. 38. 1]
F829	0829	RS485 (2) wiring type	0: 2-wire 1: 4-wire	-	-	0	Y		
F830	0830	MODBUS continuous address	0: Disabled 1: Enabled	-	-	1	Y		
F856	0856	Motor pole number for communication	1: 2 pole 2: 4 pole 3: 6 pole 4: 8 pole 5: 10 pole 6: 12 pole 7: 14 pole 8: 16 pole	-	-	2	Y		
F870	0870	Block write data 1	0: Disabled 1: FA00 (Communication command 1) 2: FA20 (Communication command 2)	-	-	0	Y		
F871	0871	Block write data 2	3: FA01 (Frequency command) 4: FA50 (TB output) 5: FA51 (Analog output) 6: FA13 (Speed command by communication)	-	-	0	Y		

Title	Communication No.	Parameter name	Adjustment range	Unit	Minimum setting unit (Panel/Communication)	Default setting	Write during running *6	User setting	Reference
F875	0875	Block read data 1	0: Disabled	-	-	0	Y		
F876	0876	Block read data 2	1: FD01 (Status information)	-	-	0	Y		
F877	0877	Block read data 3	2: FD00 (Output frequency)	-	-	0	Y		
F878	0878	Block read data 4	3: FD03 (Output current)	-	-	0	Y		
			4: FD05 (Output voltage)						
			5: FC91 (Alarm information)						
			6: FD22 (PID feedback value)						
			7: FD06 (Input terminal monitor)						
			8: FD07 (Output terminal monitor)						
			9: FE35 (Terminal RR monitor)						
			10: FE36 (Terminal RX monitor)						
			11: FE37 (Terminal II monitor)						
			12: FD04 (Input voltage (DC detection))						
F879	0879	Block read data 5	13: FD16 (Speed feedback frequency)	-	-	0	Y		[6. 38. 1]
			14: FD18 (Torque)						
			15: FE60 (My function output monitor 1)						
			16: FE61 (My function output monitor 2)						
			17: FE62 (My function output monitor 3)						
			18: FE63 (My function output monitor 4)						
			19: 0880 (Free memorandum)						
			20: FD90 (Motor speed)						
			21: FD29 (Input power)						
			22: FD30 (Output power)						
			23: FC90 (Trip information)						
F880	0880	Free memorandum	0-65535	-	1/1	0	Y		[6. 38. 3]
F896	0896	Parameter for manufacturer	-	-	-	-	-		-
F897	0897	Parameter writing	0: Storage to memory device 1: Storage to memory device except by communication	-	-	0	Y		-
F898	0898	Trip reset	0: Clear trip by request from communication option. Reset by request except from communication option. 1: Reset 2: Trip clear 3 - 5: -	-	-	0	N		-

Title	Communication No.	Parameter name	Adjustment range	Unit	Minimum setting unit (Panel/Communication)	Default setting	Write during running *6	User setting	Reference
F899	0899	Communication option reset	0: - 1: Reset option and inverter	-	-	0	N		[6. 38. 1]
F907	0907	PM regenerative over-flux upper limit	0 - 150	%		50	N		-
F908	0908	PM no load current	0 - 100	%		0	N		-
F909	0909	PM step-out detection frequency rate	0 - 100	%		0	N		-
F910	0910	PM step-out detection current level	1 - 150	%		100	N		[6. 39]
F911	0911	PM step-out detection time	0.00: Disabled 0.01 - 2.55	s		0.00	N		
F912	0912	PM q-axis inductance	0.01 - 650.0	mH		10.00	N		[6. 23. 2]
F913	0913	PM d-axis inductance	0.01 - 650.0	mH		10.00	N		
F914	0914	Parameter for manufacturer	-	-	-	-	-		-
F915	0915	PM control method	0: Method 0 1: Method 1 2: Method 2 3: Method 3 4: Method 4	-	-	3	N		[6. 23. 2]
F916	0916	PM starting current	0 - 100	%		25	N		-
F917	0917	IPM maximum torque control	0: Disabled 1: Enabled	-		0	Y		-
F918	0918	IPM current phase adjustment	-45.0 to +45.0	°C		0.0	Y		-
F919	0919	Parameter for manufacturer	-	-	-	-	-		-
F920	0920	Parameter for manufacturer	-	-	-	-	-		-
F921	0921	SPM initial position estimation current	10 - 150	%		100	N		-
F922	0922	PM HF control speed estimation response	5 - 80	Hz		15	N		-
F923	0923	PM control switching speed	5 - 100	%		25	N		-
F924	0924	PM speed estimation filter cutoff frequency	1 - 80	Hz		30	N		-
F925	0925	PM HF control speed estimation stabilization coefficient	0.50 - 2.50			1.00	N		-
F926	0926	PM HF control harmonic frequency	100 - 1000	Hz		500	N		-

Title	Communication No.	Parameter name	Adjustment range	Unit	Minimum setting unit (Panel/Communication)	Default setting	Write during running *6	User setting	Reference
F927	0927	PM HF control current level	5 - 100	%		25	N		-
F928	0928	PM initial position estimation time	0 - 1000	ms		125	N		-
F929	0929	PM dead time compensation time	-1 to +32767	ns		0	N		-
F930	0930	Parameter for manufacturer	-	-	-	-	-		-
F964	0964	Preset speed 16	LL - UL	Hz		0.0	Y		[5. 3. 7]
F965	0965	Preset speed 17	LL - UL	Hz		0.0	Y		
F966	0966	Preset speed 18	LL - UL	Hz		0.0	Y		
F967	0967	Preset speed 19	LL - UL	Hz		0.0	Y		
F968	0968	Preset speed 20	LL - UL	Hz		0.0	Y		
F969	0969	Preset speed 21	LL - UL	Hz		0.0	Y		
F970	0970	Preset speed 22	LL - UL	Hz		0.0	Y		
F971	0971	Preset speed 23	LL - UL	Hz		0.0	Y		
F972	0972	Preset speed 24	LL - UL	Hz		0.0	Y		
F973	0973	Preset speed 25	LL - UL	Hz		0.0	Y		
F974	0974	Preset speed 26	LL - UL	Hz		0.0	Y		
F975	0975	Preset speed 27	LL - UL	Hz		0.0	Y		
F976	0976	Preset speed 28	LL - UL	Hz		0.0	Y		
F977	0977	Preset speed 29	LL - UL	Hz		0.0	Y		
F978	0978	Preset speed 30	LL - UL	Hz		0.0	Y		
F979	0979	Preset speed 31	LL - UL	Hz		0.0	Y		
F980	0980	Traverse operation	0: Disabled 1: Enabled	-	-	0	N		[6. 40]
F981	0981	Traverse Acc time	0.1 - 120.0	s		25.0	Y		
F982	0982	Traverse Dec time	0.1 - 120.0	s		25.0	Y		
F983	0983	Traverse step	0.0 - 25.0	%		10.0	Y		
F984	0984	Traverse jump step	0.0 - 50.0	%		10.0	Y	F	

\*1 Parameter values vary depending on the capacity. For details, refer to [11. 6].  
 \*2 Depending on the setup menu. Refer to [11. 10].  
 \*3 For details on the analog output and monitor output function, refer to [11. 7].  
 \*4 Refer to section [11. 8] for details about the input terminal function.  
 \*5 Refer to section [11. 9] for details about the output terminal function.  
 \*6 Y: Writable N: Not writable

## 11.4 Advanced parameter

Title	Function	Reference
Starting at A000	Calendar function	E6582110
Starting at A200	Pump control	E6582124
Starting at A300	Multi PID	E6582112
Starting at A800 Starting at A900	My function	E6582114

## 11.5 Communication parameter

Title	Function	Reference
C001 - C111	Common to communication options	*1
C152 - C157 C500 - C556	For PROFINET option	E6582051
C606 - C699	For embedded Ethernet	E6582125

\*1 Refer to each Instruction Manual for option about detail specifications and common parameters.

# 11.6 Parameter setting range and default setting depending on capacity

■ HD rating

Voltage class	Applicable motor (kW)	Inverter type-form	vb,F172, F176,F180 (%)	ACC,dEC, F500, F501, F510, F511, F514, F515 (s)	tHrA,F182,F183, F184		F249 (kHz)	F298 (V)	
					Adjustment range	(A)			
3-phase 240 V	0.4	VFAS3-	2004P	4.80	10.0	0.33-3.30	3.30	4.0	120.0
	0.75		2007P	4.80	10.0	0.46-4.60	4.60	4.0	120.0
	1.5		2015P	4.80	10.0	0.80-8.00	8.00	4.0	120.0
	2.2		2022P	3.10	10.0	1.12-11.20	11.20	4.0	120.0
	4.0		2037P	3.10	10.0	1.87-18.70	18.70	4.0	120.0
	5.5		2055P	2.50	10.0	2.54-25.40	25.40	4.0	120.0
	7.5		2075P	2.30	10.0	3.27-32.70	32.70	4.0	120.0
	11		2110P	1.80	10.0	4.68-46.80	46.80	4.0	120.0
	15		2150P	1.60	10.0	6.34-63.40	63.40	4.0	120.0
	18.5		2185P	1.50	30.0	7.84-78.40	78.40	4.0	120.0
	22		2220P	1.70	30.0	9.3-92.6	92.6	4.0	120.0
	30		2300P	1.40	30.0	12.3-123.0	123.0	4.0	120.0
	37		2370P	0.90	30.0	14.9-149.0	149.0	4.0	120.0
	45		2450P	0.80	30.0	17.6-176.0	176.0	2.5	120.0
55	2550P	0.80	30.0	21.1-211.0	211.0	2.5	120.0		
3-phase 480 V	0.4	VFAS3-	4004PC	4.80	10.0	0.15-1.50	1.50	4.0	240.0
	0.75		4007PC	4.80	10.0	0.22-2.20	2.20	4.0	240.0
	1.5		4015PC	4.80	10.0	0.40-4.00	4.00	4.0	240.0
	2.2		4022PC	3.10	10.0	0.56-5.60	5.60	4.0	240.0
	4.0		4037PC	3.10	10.0	0.93-9.30	9.30	4.0	240.0
	5.5		4055PC	2.50	10.0	1.27-12.70	12.70	4.0	240.0
	7.5		4075PC	2.30	10.0	1.65-16.50	16.50	4.0	240.0
	11		4110PC	1.80	10.0	2.35-23.50	23.50	4.0	240.0
	15		4150PC	1.60	10.0	3.17-31.70	31.70	4.0	240.0
	18.5		4185PC	1.50	30.0	3.92-39.20	39.20	4.0	240.0
	22		4220PC	1.70	30.0	4.63-46.30	46.30	4.0	264.0
	30		4300PC	1.40	30.0	6.15-61.50	61.50	4.0	264.0
	37		4370PC	0.90	30.0	7.45-74.50	74.50	4.0	264.0
	45		4450PC	0.80	30.0	8.8-88.0	88.0	4.0	264.0
	55		4550PC	0.80	30.0	10.6-106.0	106.0	4.0	264.0
	75		4750PC	1.40	60.0	14.5-145.0	145.0	4.0	264.0
	90		4900PC	1.30	60.0	17.3-173.0	173.0	2.5	240.0
	110		4110KPC	1.00	60.0	21.1-211.0	211.0	2.5	240.0
	132		4132KPC	0.80	60.0	25.0-250.0	250.0	2.5	240.0
	160		4160KPC	0.80	60.0	31.4-314.0	314.0	2.5	240.0
220	4200KPC	0.80	60.0	38.7-387.0	387.0	2.5	240.0		
250	4220KPC	0.80	60.0	42.7-427.0	427.0	2.5	240.0		
280	4280KPC	0.80	60.0	55.0-550.0	550.0	2.5	240.0		



Voltage class	Applicable motor (kW)	Inverter type-form	F300		F308 (Ohm)	F309 (kW)	F316	F356 (s)	F402 (%)	F405		
			Adjustment range	(kHz)						<Set> = "JP" (kW)	other (kW)	
3-phase 240 V	0.4	VFAS3-	2004P	1.0-16.0	4.0	200.0	0.12	1	0.57	4.30	0.40	0.40
	0.75		2007P	1.0-16.0	4.0	200.0	0.12	1	0.57	4.30	0.75	0.75
	1.5		2015P	1.0-16.0	4.0	75.0	0.12	1	0.57	4.40	1.50	1.50
	2.2		2022P	1.0-16.0	4.0	75.0	0.12	1	0.57	2.90	2.20	2.20
	4.0		2037P	1.0-16.0	4.0	40.0	0.12	1	0.67	2.80	3.70	4.00
	5.5		2055P	1.0-16.0	4.0	20.0	0.24	1	0.87	2.30	5.50	5.50
	7.5		2075P	1.0-16.0	4.0	15.0	0.44	1	0.87	2.00	7.50	7.50
	11		2110P	1.0-16.0	4.0	10.0	0.66	1	1.07	1.60	11.00	11.00
	15		2150P	1.0-16.0	4.0	7.5	0.88	1	1.07	1.50	15.00	15.00
	18.5		2185P	1.0-16.0	4.0	7.5	0.88	1	1.37	1.40	18.50	18.50
	22		2220P	1.0-8.0	4.0	3.3	1.76	1	1.37	1.60	22.00	22.00
	30		2300P	1.0-8.0	4.0	3.3	1.76	1	1.37	1.20	30.00	30.00
	37		2370P	1.0-8.0	4.0	2.0	2.20	1	1.37	0.80	37.00	37.00
	45		2450P	1.0-8.0	2.5	2.0	2.20	1	1.37	0.70	45.00	45.00
55	2550P	1.0-8.0	2.5	2.0	2.20	1	1.37	0.80	55.00	55.00		
3-phase 480 V	0.4	VFAS3-	4004PC	1.0-16.0	4.0	200.0	0.12	3	0.57	4.30	0.40	0.40
	0.75		4007PC	1.0-16.0	4.0	200.0	0.12	3	0.57	4.30	0.75	0.75
	1.5		4015PC	1.0-16.0	4.0	200.0	0.12	3	0.57	4.40	1.50	1.50
	2.2		4022PC	1.0-16.0	4.0	200.0	0.12	3	0.57	2.90	2.20	2.20
	4.0		4037PC	1.0-16.0	4.0	160.0	0.12	3	0.67	2.80	3.70	4.00
	5.5		4055PC	1.0-16.0	4.0	80.0	0.24	3	0.87	2.30	5.50	5.50
	7.5		4075PC	1.0-16.0	4.0	60.0	0.44	3	0.87	2.00	7.50	7.50
	11		4110PC	1.0-16.0	4.0	40.0	0.66	3	1.07	1.60	11.00	11.00
	15		4150PC	1.0-16.0	4.0	30.0	0.88	3	1.07	1.50	15.00	15.00
	18.5		4185PC	1.0-16.0	4.0	30.0	0.88	3	1.37	1.40	18.50	18.50
	22		4220PC	1.0-16.0	4.0	15.0	1.76	3	1.37	1.60	22.00	22.00
	30		4300PC	1.0-16.0	4.0	15.0	1.76	3	1.37	1.20	30.00	30.00
	37		4370PC	1.0-16.0	4.0	8.0	1.76	3	1.37	0.80	37.00	37.00
	45		4450PC	1.0-8.0	4.0	8.0	1.76	3	1.37	0.70	45.00	45.00
	55		4550PC	1.0-8.0	4.0	8.0	1.76	3	1.37	0.80	55.00	55.00
	75		4750PC	1.0-8.0	4.0	8.0	1.76	3	1.37	1.30	75.00	75.00
	90		4900PC	1.0-8.0	2.5	3.7	7.40	3	1.37	1.20	90.00	90.00
	110		4110KPC	1.0-8.0	2.5	3.7	7.40	3	1.37	0.90	110.00	110.00
	132		4132KPC	1.0-8.0	2.5	3.7	7.40	3	1.37	0.80	132.00	132.00
160	4160KPC	1.0-8.0	2.5	3.7	7.40	3	1.37	0.80	160.00	160.00		
220	4200KPC	1.0-8.0	2.5	1.9	8.70	3	1.37	0.80	200.00	200.00		
250	4220KPC	1.0-8.0	2.5	1.9	8.70	3	1.37	0.80	220.00	220.00		
280	4280KPC	1.0-8.0	2.5	1.4	14.00	3	1.37	0.80	280.00	280.00		

Voltage class	Applicable motor (kW)	Inverter type-form	F412 (%)	F415		F416 (%)	F417		F456	F749	
				Adjustment range	(A)		50Hz setting	60Hz setting			
							(min-1)				
3-phase 240 V	0.4	VFAS3-	2004P	7.0	0.01-99.99	1.70	55	1440	1730	100	0
	0.75		2007P	7.0	0.01-99.99	3.40	55	1440	1730	100	0
	1.5		2015P	5.0	0.01-99.99	6.40	42	1445	1740	100	0
	2.2		2022P	5.0	0.01-99.99	9.40	50	1460	1755	100	0
	4.0		2037P	5.0	0.01-99.99	14.60	38	1460	1755	100	1
	5.5		2055P	5.0	0.01-99.99	21.40	41	1465	1760	100	1
	7.5		2075P	5.0	0.01-99.99	28.60	38	1460	1755	100	1
	11		2110P	4.0	0.01-99.99	42.00	38	1475	1770	100	1
	15		2150P	4.0	0.01-99.99	55.60	33	1470	1760	100	1
	18.5		2185P	4.0	0.01-99.99	69.00	37	1475	1770	100	1
	22		2220P	4.0	0.1-999.9	80.0	32	1470	1760	100	1
	30		2300P	4.0	0.1-999.9	108.0	33	1470	1765	100	1
	37		2370P	4.0	0.1-999.9	132.0	32	1480	1775	100	2
	45		2450P	3.0	0.1-999.9	159.0	31	1480	1775	100	2
	55		2550P	3.0	0.1-999.9	192.0	28	1480	1775	100	2
3-phase 480 V	0.4	VFAS3-	4004PC	7.0	0.01-99.99	0.85	55	1440	1730	100	0
	0.75		4007PC	7.0	0.01-99.99	1.70	55	1440	1730	100	0
	1.5		4015PC	5.0	0.01-99.99	3.20	42	1445	1740	100	0
	2.2		4022PC	5.0	0.01-99.99	4.70	50	1460	1755	100	0
	4.0		4037PC	5.0	0.01-99.99	7.30	38	1460	1755	100	1
	5.5		4055PC	5.0	0.01-99.99	10.70	41	1465	1760	100	1
	7.5		4075PC	5.0	0.01-99.99	14.30	38	1460	1755	100	1
	11		4110PC	4.0	0.01-99.99	21.00	38	1475	1770	100	1
	15		4150PC	4.0	0.01-99.99	27.80	33	1470	1760	100	1
	18.5		4185PC	4.0	0.01-99.99	34.50	37	1475	1770	100	1
	22		4220PC	4.0	0.01-99.99	40.00	32	1470	1760	100	1
	30		4300PC	4.0	0.01-99.99	54.00	33	1470	1765	95	1
	37		4370PC	4.0	0.01-99.99	66.00	32	1480	1775	100	2
	45		4450PC	3.0	0.1-999.9	79.5	31	1480	1775	100	2
	55		4550PC	3.0	0.1-999.9	96.0	28	1480	1775	100	2
	75		4750PC	3.0	0.1-999.9	129.0	28	1480	1775	95	2
	90		4900PC	3.0	0.1-999.9	154.0	26	1480	1775	100	2
	110		4110KPC	3.0	0.1-999.9	190.0	21	1480	1780	100	2
	132		4132KPC	3.0	0.1-999.9	230.0	20	1485	1780	100	2
	160		4160KPC	3.0	0.1-999.9	252.0	20	1485	1785	100	2
220	4200KPC	3.0	0.1-999.9	315.0	20	1485	1785	100	2		
250	4220KPC	3.0	0.1-999.9	345.0	20	1485	1785	100	2		
280	4280KPC	3.0	0.1-999.9	445.0	20	1485	1785	100	2		

■ **ND rating**

Voltage class	Applicable motor (kW)	Inverter type-form	vb,F172,F176,F180 (%)	ACC,dEC,F500,F501,F510,F511,F514,F515 (s)	tHrA,F182,F183,F184		F249 (kHz)	F298 (V)	
					Adjustment range	(A)			
3-phase 240 V	0.75	VFAS3-	2004P	4.80	10.0	0.46-4.60	4.60	4.0	120.0
	1.5		2007P	4.80	10.0	0.80-8.00	8.00	4.0	120.0
	2.2		2015P	3.10	10.0	1.12-11.20	11.20	4.0	120.0
	4.0		2022P	3.10	10.0	1.87-18.70	18.70	4.0	120.0
	5.5		2037P	2.50	10.0	2.54-25.40	25.40	4.0	120.0
	7.5		2055P	2.30	10.0	3.27-32.70	32.70	4.0	120.0
	11		2075P	1.80	10.0	4.68-46.80	46.80	4.0	120.0
	15		2110P	1.60	10.0	6.34-63.40	63.40	4.0	120.0
	18.5		2150P	1.50	30.0	7.84-78.40	78.40	4.0	120.0
	22		2185P	1.70	30.0	9.3-92.6	92.6	4.0	120.0
	30		2220P	1.40	30.0	12.3-123.0	123.0	4.0	120.0
	37		2300P	0.90	30.0	14.9-149.0	149.0	4.0	120.0
	45		2370P	0.80	30.0	17.6-176.0	176.0	4.0	120.0
	55		2450P	0.80	30.0	21.1-211.0	211.0	2.5	120.0
75	2550P	1.40	60.0	28.2-282.0	282.0	2.5	120.0		
3-phase 480 V	0.75	VFAS3-	4004PC	4.80	10.0	0.22-2.20	2.20	4.0	240.0
	1.5		4007PC	4.80	10.0	0.40-4.00	4.00	4.0	240.0
	2.2		4015PC	3.10	10.0	0.56-5.60	5.60	4.0	240.0
	4.0		4022PC	3.10	10.0	0.93-9.30	9.30	4.0	240.0
	5.5		4037PC	2.50	10.0	1.27-12.70	12.70	4.0	240.0
	7.5		4055PC	2.30	10.0	1.65-16.50	16.50	4.0	240.0
	11		4075PC	1.80	10.0	2.35-23.50	23.50	4.0	240.0
	15		4110PC	1.60	10.0	3.17-31.70	31.70	4.0	240.0
	18.5		4150PC	1.50	30.0	3.92-39.20	39.20	4.0	240.0
	22		4185PC	1.70	30.0	4.63-46.30	46.30	4.0	240.0
	30		4220PC	1.40	30.0	6.15-61.50	61.50	4.0	264.0
	37		4300PC	0.90	30.0	7.45-74.50	74.50	4.0	264.0
	45		4370PC	0.80	30.0	8.8-88.0	88.0	4.0	264.0
	55		4450PC	0.80	30.0	10.6-106.0	106.0	4.0	264.0
	75		4550PC	1.40	60.0	14.5-145.0	145.0	4.0	264.0
	90		4750PC	1.30	60.0	17.3-173.0	173.0	4.0	264.0
	110		4900PC	1.00	60.0	21.1-211.0	211.0	2.5	240.0
	132		4110KPC	0.80	60.0	25.0-250.0	250.0	2.5	240.0
	160		4132KPC	0.80	60.0	31.4-302.0	302.0	2.5	240.0
	220		4160KPC	0.80	60.0	38.7-427.0	427.0	2.5	240.0
250	4200KPC	0.80	60.0	42.7-481.0	481.0	2.5	240.0		
280	4220KPC	0.80	60.0	55.0-550.0	550.0	2.5	240.0		
315	4280KPC	0.60	60.0	61.6-616.0	616.0	2.5	240.0		

Voltage class	Applicable motor (kW)	Inverter type-form	F300		F308 (Ohm)	F309 (kW)	F316	F356 (s)	F402 (%)	F405		
			Adjustment range	(kHz)						<Set>="JP"	other (kW)	
3-phase 240 V	0.75	VFAS3-	2004P	1.0-16.0	4.0	200.0	0.12	1	0.57	4.30	0.75	0.75
	1.5		2007P	1.0-16.0	4.0	75.0	0.12	1	0.57	4.40	1.50	1.50
	2.2		2015P	1.0-16.0	4.0	75.0	0.12	1	0.57	2.90	2.20	2.20
	4.0		2022P	1.0-16.0	4.0	40.0	0.12	1	0.67	2.80	3.70	4.00
	5.5		2037P	1.0-16.0	4.0	20.0	0.24	1	0.87	2.30	5.50	5.50
	7.5		2055P	1.0-16.0	4.0	15.0	0.44	1	0.87	2.00	7.50	7.50
	11		2075P	1.0-16.0	4.0	10.0	0.66	1	1.07	1.60	11.00	11.00
	15		2110P	1.0-16.0	4.0	7.5	0.88	1	1.07	1.50	15.00	15.00
	18.5		2150P	1.0-16.0	4.0	7.5	0.88	1	1.37	1.40	18.50	18.50
	22		2185P	1.0-16.0	4.0	3.3	1.76	1	1.37	1.60	22.00	22.00
	30		2220P	1.0-8.0	4.0	3.3	1.76	1	1.37	1.20	30.00	30.00
	37		2300P	1.0-8.0	4.0	2.0	2.20	1	1.37	0.80	37.00	37.00
	45		2370P	1.0-8.0	4.0	2.0	2.20	1	1.37	0.70	45.00	45.00
	55		2450P	1.0-8.0	2.5	2.0	2.20	1	1.37	0.80	55.00	55.00
75	2550P	1.0-8.0	2.5	1.7	3.40	1	1.37	1.30	75.00	75.00		
3-phase 480 V	0.75	VFAS3-	4004PC	1.0-16.0	4.0	200.0	0.12	3	0.57	4.30	0.75	0.75
	1.5		4007PC	1.0-16.0	4.0	200.0	0.12	3	0.57	4.40	1.50	1.50
	2.2		4015PC	1.0-16.0	4.0	200.0	0.12	3	0.57	2.90	2.20	2.20
	4.0		4022PC	1.0-16.0	4.0	160.0	0.12	3	0.67	2.80	3.70	4.00
	5.5		4037PC	1.0-16.0	4.0	80.0	0.24	3	0.87	2.30	5.50	5.50
	7.5		4055PC	1.0-16.0	4.0	60.0	0.44	3	0.87	2.00	7.50	7.50
	11		4075PC	1.0-16.0	4.0	40.0	0.66	3	1.07	1.60	11.00	11.00
	15		4110PC	1.0-16.0	4.0	30.0	0.88	3	1.07	1.50	15.00	15.00
	18.5		4150PC	1.0-16.0	4.0	30.0	0.88	3	1.37	1.40	18.50	18.50
	22		4185PC	1.0-16.0	4.0	15.0	1.76	3	1.37	1.60	22.00	22.00
	30		4220PC	1.0-16.0	4.0	15.0	1.76	3	1.37	1.20	30.00	30.00
	37		4300PC	1.0-16.0	4.0	8.0	1.76	3	1.37	0.80	37.00	37.00
	45		4370PC	1.0-16.0	4.0	8.0	1.76	3	1.37	0.70	45.00	45.00
	55		4450PC	1.0-8.0	4.0	8.0	1.76	3	1.37	0.80	55.00	55.00
	75		4550PC	1.0-8.0	4.0	8.0	1.76	3	1.37	1.30	75.00	75.00
	90		4750PC	1.0-8.0	4.0	3.7	7.40	3	1.37	1.20	90.00	90.00
	110		4900PC	1.0-8.0	2.5	3.7	7.40	3	1.37	0.90	110.0	110.0
	132		4110KPC	1.0-8.0	2.5	3.7	7.40	3	1.37	0.80	132.0	132.0
	160		4132KPC	1.0-8.0	2.5	3.7	7.40	3	1.37	0.80	160.0	160.0
	220		4160KPC	1.0-8.0	2.5	1.9	8.70	3	1.37	0.80	220.0	220.0
250	4200KPC	1.0-8.0	2.5	1.9	8.70	3	1.37	0.80	250.0	250.0		
280	4220KPC	1.0-8.0	2.5	1.4	14.00	3	1.37	0.80	280.0	280.0		
315	4280KPC	1.0-8.0	2.5	1.4	14.00	3	1.37	0.60	315.0	315.0		

11

Voltage class	Applicable motor (kW)	Inverter type-form	F412 (%)	F415		F416 (%)	F417		F456	F749	
				Adjustment range	(A)		50Hz setting	60Hz setting			
							(min-1)				
3-phase 240 V	0.75	VFAS3-	2004P	7.0	0.01-99.99	3.40	55	1440	1730	100	0
	1.5		2007P	5.0	0.01-99.99	6.40	42	1445	1740	100	0
	2.2		2015P	5.0	0.01-99.99	9.40	50	1460	1755	100	0
	4.0		2022P	5.0	0.01-99.99	14.60	38	1460	1755	100	0
	5.5		2037P	5.0	0.01-99.99	21.40	41	1465	1760	100	1
	7.5		2055P	5.0	0.01-99.99	28.60	38	1460	1755	100	1
	11		2075P	4.0	0.01-99.99	42.00	38	1475	1770	100	1
	15		2110P	4.0	0.01-99.99	55.60	33	1470	1760	100	1
	18.5		2150P	4.0	0.01-99.99	69.00	37	1475	1770	100	1
	22		2185P	4.0	0.1-999.9	80.0	32	1470	1760	100	1
	30		2220P	4.0	0.1-999.9	108.0	33	1470	1765	100	1
	37		2300P	4.0	0.1-999.9	132.0	32	1480	1775	100	1
	45		2370P	3.0	0.1-999.9	159.0	31	1480	1775	100	2
	55		2450P	3.0	0.1-999.9	192.0	28	1480	1775	100	2
75	2550P	3.0	0.1-999.9	264.0	28	1480	1775	100	2		
3-phase 480 V	0.75	VFAS3-	4004PC	7.0	0.01-99.99	1.70	55	1440	1730	100	0
	1.5		4007PC	5.0	0.01-99.99	3.20	42	1445	1740	100	0
	2.2		4015PC	5.0	0.01-99.99	4.70	50	1460	1755	100	0
	4.0		4022PC	5.0	0.01-99.99	7.30	38	1460	1755	100	0
	5.5		4037PC	5.0	0.01-99.99	10.70	41	1465	1760	100	1
	7.5		4055PC	5.0	0.01-99.99	14.30	38	1460	1755	100	1
	11		4075PC	4.0	0.01-99.99	21.00	38	1475	1770	100	1
	15		4110PC	4.0	0.01-99.99	27.80	33	1470	1760	100	1
	18.5		4150PC	4.0	0.01-99.99	34.50	37	1475	1770	100	1
	22		4185PC	4.0	0.01-99.99	40.00	32	1470	1760	100	1
	30		4220PC	4.0	0.01-99.99	54.00	33	1470	1765	85	1
	37		4300PC	4.0	0.01-99.99	66.00	32	1480	1775	80	1
	45		4370PC	3.0	0.1-999.9	79.5	31	1480	1775	100	2
	55		4450PC	3.0	0.1-999.9	96.0	28	1480	1775	100	2
	75		4550PC	3.0	0.1-999.9	129.0	28	1480	1775	100	2
	90		4750PC	3.0	0.1-999.9	154.0	26	1480	1775	80	2
	110		4900PC	3.0	0.1-999.9	190.0	21	1480	1780	100	2
	132		4110KPC	3.0	0.1-999.9	230.0	20	1485	1780	100	2
	160		4132KPC	3.0	0.1-999.9	252.0	20	1485	1785	100	2
	220		4160KPC	3.0	0.1-999.9	315.0	20	1485	1785	100	2
250	4200KPC	3.0	0.1-999.9	345.0	20	1485	1785	100	2		
280	4220KPC	3.0	0.1-999.9	445.0	20	1485	1785	100	2		
315	4280KPC	3.0	0.1-999.9	544.0	20	1485	1785	100	2		

# 11.7 Analog output/Monitor output function

Option No.	Communication No.		Function	Display unit	Unit (Communication)
	Analog output	Monitor output			
0	FD00	FE00	Output frequency	0.1Hz	0.01Hz
1	FD02	FE02	Frequency command value	0.1Hz	0.01Hz
2	FD03	FE03	Output current	1%/<F701> setting	0.01%
3	FD04	FE04	Input voltage (DC detection)	1%/<F701> setting	0.01%
4	FD05	FE05	Output voltage	1%/<F701> setting	0.01%
5	FD15	FE15	Stator frequency	0.1Hz	0.01Hz
6	FD16	FE16	Speed feedback frequency (real time)	0.1Hz	0.01Hz
7	FD17	FE17	Speed feedback frequency (1-second filter)	0.1Hz	0.01Hz
8	FD18	FE18	Torque	1%	0.01%
9	FD19	FE19	Torque command	1%	0.01%
10	FD99	FE99	Output frequency during run. Frequency command value during stop.	Hz/free unit	-
11	FD20	FE20	Torque current	1%	0.01%
12	FD21	FE21	Exciting current	1%	0.01%
13	FD22	FE22	PID feedback value	0.1Hz	0.01Hz
14	FD23	FE23	Motor overload factor (OL2 data)	1%	0.01%
15	FD24	FE24	Inverter overload factor (OL1 data)	1%	0.01%
16	FD25	FE25	Braking resistor overload factor (OLr data)	1%	1%
17	FD28	FE28	Braking resistor load factor (%ED)	1%	1%
18	DF29	FE29	Input power	0.1kW	0.01kW
19	FD30	FE30	Output power	0.1kW	0.01kW
20	FE76	FE76	Input cumulative power	<F749> setting	<F749> setting
21	FE77	FE77	Output cumulative power	<F749> setting	<F749> setting
22			Fixed output 1	-	-
23			Fixed output 2	-	-
24	FE35	FE35	Terminal RR input value	1%	0.01%
25	FE36	FE36	Terminal RX input value	1%	0.01%
26	FE37	FE37	Terminal II input value	1%	0.01%
27	FD94	FE94	Motor speed command *4	1	1
28	FE40	FE40	Terminal FM output value *1	1	0.01
29	FE41	FE41	Terminal AM output value *2	1	0.01
31	FA51	FA51	Communication data output	*3	*3
32		FE66	Slot A option CPU version	-	-
33		FE67	Slot B option CPU version	-	-
34	FD26	FE26	Motor load factor	%	-
35	FD27	FE27	Inverter load factor	%	-
36		FE70	Inverter rated current	A	-
37		FD70	Inverter rated current (with carrier frequency correction )	A	-

11

Option No.	Communication No.		Function	Display unit	Unit (Communication)
	Analog output	Monitor output			
38		FD81	Actual carrier frequency	kHz	-
39		FE68	Slot C option CPU version	-	-
40		FE91	Embedded Ethernet CPU version	-	-
41	FD43	FD43	Terminal FP pulse train output value	pps	-
43		FM/F671	Terminal FM/AM gain setting value	-	-
44	FE38	FE38	Terminal AI4 input value	1%	0.01%
45	FE39	FE39	Terminal AI5 input value	1%	0.01%
46	FE60	FE60	My function monitor output 1	-	-
47	FE61	FE61	My function monitor output 2	-	-
48	FE62	FE62	My function monitor output 3	-	-
49	FE63	FE63	My function monitor output 4	-	-
62	FD48	FE48	PID result frequency	0.1Hz	0.01Hz
63	FD58	FE58	PID set value	0.1Hz	0.01Hz
64	FD50	FD50	Light-load high-speed switching load torque	1%	0.01%
65	FD51	FD51	Light-load high-speed torque during constant speed run	1%	0.01%
66		FE31	Pattern operation group number	0.1	0.1
67		FE32	Pattern operation remaining cycle number	1	1
68		FE33	Pattern operation preset speed number	1	1
69		FE34	Pattern operation remaining time	0.1	0.1
70		FE71	Inverter rated voltage	1	0.1
71	FD90	FE90	Motor speed (estimated value) *4	1	1
72		FA15	Communication option Receiving counter	1	1
73		FA16	Communication option Abnormal counter	1	1
76	FE56	FE56	Terminal S4/S5 pulse train input value	0.001	0.0001
77		FD85	My function COUNT1	1	1
78		FD86	My function COUNT2	1	1
79	FD87	FD87	Dancer control PID result frequency	0.1Hz	0.01Hz
80		FA25	Embedded Ethernet Transmission counter	1	1
81		FA17	Embedded Ethernet Receiving counter	1	1
82		FA18	Embedded Ethernet Abnormal counter	1	1
83		FE81	Connected option number	1	1
84		FD91	My function COUNT3	1	1
85		FD92	My function COUNT4	1	1
86		FD93	My function COUNT5	1	1
90		FE80	Cumulative power ON time	100 hours	-
91		FD41	Cumulative cooling fan run time	100 hours	-
92		FD14	Cumulative run time	100 hours	-
93		FD31	Cumulative overcurrent time	-	-
95		E960	Pump 0 run time	100 hours	-
96		E961	Pump 1 run time	100 hours	-
97		E962	Pump 2 run time	100 hours	-

Option No.	Communication No.		Function	Display unit	Unit (Communication)
	Analog output	Monitor output			
98		E963	Pump 3 run time	100 hours	-
99		E964	Pump 4 run time	100 hours	-
100		FD32	Number of starting	10000 times	-
101		FD33	Number of Fwd starting	10000 times	-
102		FD34	Number of Rev starting	10000 times	-
103		FE59	External equipment counter	Times	-
105		E965	Pump 5 run time	100 hours	-
106		E966	Pump 6 run time	100 hours	-
107		E967	Pump 7 run time	100 hours	-
108		E968	Pump 8 run time	100 hours	-
109		E969	Pump 9 run time	100 hours	-
110		FD35	Number of trip	Times	-
111		FD36	Number of serious failure trip	Times	-
112		FD37	Number of slight failure trip	Times	-
113		FD38	Number of specified trip 1	Times	-
114		FD39	Number of specified trip 2	Times	-
115		FD40	Number of specified trip 3	Times	-
120	FD83	FE83	Internal temperature 1	-	-
124	FE78	FE78	Power circuit board temperature	-	-
130	FD96	FD96	External PID3 set value	-	-
131	FD97	FD97	External PID3 feedback value	-	-
132	FD98	FD98	External PID3 result value	-	-
133	FE96	FE96	External PID4 set value	-	-
134	FE97	FE97	External PID4 feedback value	-	-
135	FE98	FE98	External PID4 result value	-	-
150	FD00 *5	FE00	Signed output frequency	0.1Hz	0.01Hz
151	FD02 *5	FE02	Signed frequency command value	0.1Hz	0.01Hz
152	FD15 *5	FE15	Signed stator frequency	0.1Hz	0.01Hz
153	FD16 *5	FE16	Signed speed feedback frequency (real time)	0.1Hz	0.01Hz
154	FD17 *5	FE17	Signed speed feedback frequency (1-second filter)	0.1Hz	0.01Hz
155	FD18	FE18	Signed torque	1%	0.01%
156	FD19	FE19	Signed torque command	1%	0.01%
158	FD20	FE20	Signed torque current	1%	0.01%
159	FD22 *5	FE22	Signed PID feedback value	0.1Hz	0.01Hz
160	FE37	FE37	Signed terminal RX input value	1%	0.01%
161	FE38	FE38	Signed terminal AI4 input value	1%	0.01%
162	FE39	FE39	Signed terminal AI5 input value	1%	0.01%

\*1 Disabled with <FMSL: Terminal FM function>.

\*2 Disabled with <F670: Terminal AM function>.

\*3 For details, refer to RS485 Communication Function Instruction Manual (Exxxxxx).

\*4 Monitor is limited from -32700 to 32700.

\*5 FD00(FE00), FD02(FE02), FD15(FE15), FD16(FE16), FD17(FE17), FD22(EF22) are unsigned value. Internal polarity is used for signed analog output or monitor.



# 11. 8 Input terminal function

The function No. in the following table can be assigned to parameters <F110>-<F124>, <F127>, <F128>. and <F151>-<F158>.

Function number		Symbol	Function	Action	Reference
Positive logic	Negative logic				
0	1	-	No function	Disabled	-
2	3	F	Fwd run	ON: Forward run (except deceleration stop) OFF: Deceleration stop	[7. 2. 1]
4	5	R	Rev run	ON: Reverse run (except deceleration stop) OFF: Deceleration stop	
6	7	ST	Standby	ON: Ready for operation, OFF: Coast stop (gate OFF)	[5. 4. 2] [6. 3. 1] [6. 34. 8] [6. 8. 2] [7. 2. 1]
8	9	RES1	Reset 1	ON: Acceptance of reset command, ON→OFF: Trip reset	[7. 2. 1] [13. 1]
10	11	SS1	Preset speed switching 1	Selection of 31-speed SS1 to SS5 (5 bits)	[5. 3. 7] [7. 2. 1]
12	13	SS2	Preset speed switching 2		
14	15	SS3	Preset speed switching 3		
16	17	SS4	Preset speed switching 4		
18	19	JOG	Jog run	ON: Jog run enabled	[6. 10] [7. 2. 1]
20	21	EXT	Emergency off	ON: "E" trip after <F603> operation	[6. 30. 4] [7. 2. 1]
22	23	DB	DC braking	ON: DC braking	[6. 8. 1] [6. 8. 3] [7. 2. 1]
24	25	AD1	Acc/Dec switching 1	Selection of Acc/Dec 1 - 4 AD2, AD3 (2 bits)	[7. 2. 1]
26	27	AD2	Acc/Dec switching 2		
28	29	VFSW1	V/f switching 1	Selection of V/f 1 - 4 VFSW1, VFSW2 (2 bits)	
30	31	VFSW2	V/f switching 2		
32	33	OCS2	Stall prevention switching/Torque limit switching 1	ON: <F185: Stall prevention level 2> enabled OFF: <F601: Stall prevention level 1> enabled	[6. 24. 1] [6. 27. 2] [6. 30. 2] [7. 2. 1]
34	35	TRQL2	Torque limit switching 2	Selection of Power running/Regenerative torque limit 1 - 4 OCS2, TRQL1 (2 bits)	[6. 24. 1] [6. 27. 2] [7. 2. 1]
36	37	PID	PID control OFF	ON: PID control OFF	[5. 3. 8] [7. 2. 1]
38	39	PTTN1	Pattern operation 1	ON: Pattern operation 1 enabled	[6. 28] [7. 2. 1]
40	41	PTTN2	Pattern operation 2	ON: Pattern operation 2 enabled	
42	43	PTTNC	Pattern operation continuation	ON: Pattern operation continued	
44	45	PTTNS	Pattern operation start	ON: Pattern operation start	
46	47	OH2	External thermal trip	ON: "OH2" trip	[7. 2. 1]

Function number		Symbol	Function	Action	Reference
Positive logic	Negative logic				
48	49	SCLC	Communication priority cancel	ON: Run at the setting of <CMOd: Run command select> and <FMOd: Frequency command select 1> OFF: Run by communication	[6. 38. 2] [7. 2. 1]
50	51	HD	3-wire operation hold/stop	ON: Forward run (F), Reverse run (R) held, 3-wire operation OFF: Deceleration stop	[7. 2. 1]
52	53	IDC	PID differential/integral reset	ON: PID differential/integral cleared	[5. 3. 8] [7. 2. 1]
54	55	PIDSW	PID plus/minus switching	ON: Plus/minus characteristics of <F359: PID control 1> setting OFF: Characteristics of <F359: PID control 1> setting	[7. 2. 1]
56	57	FORCE	Forced run	ON: Forced run, continues in a slight failure condition (Set <F650: Forced run> = "1: Enabled". Frequency command value = <F294: Preset speed 15 / Forced run speed>.) *Stop with power off	[6. 12. 2] [6. 31] [7. 2. 1]
58	59	FIRE	Fire speed run	ON: Fire speed run (Set <F650: Fire speed run> = "1: Enabled". Frequency command value = <F294: Preset speed 15 / Forced run speed>.) *Stop with power off	
60	61	DWELL	Dwell operation	ON: Dwell operation (Stop acceleration and deceleration and run the motor at a constant speed)	[6. 19] [7. 2. 1]
62	63	KEB	Synchronized Acc/Dec	ON: Deceleration stop with synchronizing at power failure	[7. 2. 1]
64	65	MYF	My function start	ON: My function start (When <A977: My function> = "1: Enabled by permission signal")	
66	67	AUTT	Offline auto-tuning	<F400> = "3" ON: Offline auto-tuning executed <F400> = "6" ON: Offline auto-tuning executed at run command while this signal is ON. <F400> = "7" ON: Offline auto-tuning executed only for <F402> at run command while this signal is ON.	[6. 23. 1] [6. 23. 2] [7. 2. 1]
68	69	SGSW	Speed control gain switching	ON: Use F463-F465 OFF: Use F460-F462	[7. 2. 1]
70	71	SRVL	Servo lock	ON: Servo lock	
72	73	SIMP	Simple positioning	ON: Simple positioning operation	
74	75	CKWH	Cumulative power monitor clear	ON: Clear cumulative power (kWh) monitor display	[6. 36] [7. 2. 1]
76	77	TRACE	Trace trigger	ON: Trace trigger (start) signal	[7. 2. 1]
78	79	HSLL	Light-load high-speed operation inhibited	ON: Light-load high-speed operation inhibited OFF: Light-load high-speed operation permitted	
80	81	HDFP	Terminal FP output hold	ON: Terminal [FP] is held ON once turned ON	
82	83	HDR1	Terminal R1 output hold	ON: Terminal [R1] is held ON once turned ON	
84	85	HDR2	Terminal R2 output hold	ON: Terminal [R2] is held ON once turned ON	
88	89	UP	Terminal Up frequency	ON: Frequency command increased	
90	91	DOWN	Terminal Down frequency	ON: Frequency command decreased	[6. 6. 5] [7. 2. 1]
92	93	CLR	Terminal Up, Down frequency clear	OFF-> ON: Clear Terminal Up, Down frequency command	[7. 2. 1]
94	95	DANC	Dancer correction OFF	ON: Dancer correction OFF	[7. 2. 1]
96	97	FRR	Coast stop	ON: Coast stop (gate OFF)	[6. 34. 8] [7. 2. 1]
98	99	FR	Fwd/Rev	ON: Forward command, OFF: Reverse command	[7. 2. 1]
100	101	RS	Run/Stop	ON: Run command, OFF: Stop command	

Function number		Symbol	Function	Action	Reference
Positive logic	Negative logic				
102	103	CPSW	Commercial power run switching	ON: Commercial power run, OFF: Inverter run	[6. 20] [7. 2. 1]
104	105	FCHG	FMOd/F207 priority switching	ON: <F207: Frequency command select 2> enabled (When <F200: Frequency command priority select> = "0") OFF: <FMOd: Frequency command select 1> enabled	[5. 4. 1] [7. 2. 1]
106	107	FMTB	Terminal II priority	ON: Frequency command of Terminal [II] enabled OFF: <FMOd: Frequency command select 1> enabled	[7. 2. 1]
108	109	CMTB	Terminal run priority	ON: Run command of terminal enabled OFF: <CMO: Run command select> enabled	[5. 2. 1] [7. 2. 1]
110	111	PWE	Parameter writing unlocked	ON: Parameter writing unlocked OFF: <F700: Parameter reading & writing access lockout> setting	[6. 34. 1] [7. 2. 1]
112	113	STSW	Speed control/Torque control switching	ON: Torque control, OFF: Speed control	[7. 2. 1]
114	115	EXCUT	External equipment counter	ON: Count the signals (Monitor number "103" can monitor the number of ON signal)	[6. 30. 21] [7. 2. 1]
116	117	PI1SW	PID 1, 2 switching	ON: PID2, OFF: PID1	[7. 2. 1]
118	119	SS5	Preset speed switching 5	Selection of 31-speed SS1 to SS5 (5 bits)	[5. 3. 7] [7. 2. 1]
120	121	FSTP1	Quick deceleration 1	ON: Dynamic quick deceleration OFF: Canceled *Operation is resumed when dynamic quick deceleration is canceled	[7. 2. 1]
122	123	FSTP2	Quick deceleration 2	ON: Quick deceleration OFF: Canceled *Operation is resumed when quick deceleration is canceled	
124	125	PREX	Preliminary excitation	ON: Preliminary excitation	
126	127	BRK	Brake	ON: Brake closed	
130	131	BRKA	Brake answerback	ON: Comparison signal with output terminal function "68: During brake release" ("E-11" trip when mismatching)	[6. 30. 15] [7. 2. 1]
134	135	TVS	Traverse operation	ON: Traverse operation permission	[7. 2. 1]
136	137	RSC	Rescue operation	ON: Rescue operation (Low voltage operation)	
138	139	PMP SW	Pump control switching	ON: Pump switching during pump control	
140	141	SLOWF	Fwd slowdown	ON: Forward run toward the setting value of <F383: Hit and stop frequency>	
142	143	STOPF	Fwd stop	ON: Stop (Forward run only)	
144	145	SLOWR	Rev slowdown	ON: Reverse run toward the setting value of <F383: Hit and stop frequency>	
146	147	STOPR	Rev stop	ON: Stop (Reverse run only)	
148	149	SLOFR	Fwd/Rev slowdown	ON: Stop (Forward/Reverse run)	
150	151	HSC	Hit and stop clear	ON: Hit and stop cleared	

Function number		Symbol	Function	Action	Reference
Positive logic	Negative logic				
152	153	MOT2	No. 2 motor switching	ON: No.2 motor setting + No.2 Acc/Dec + No.2 Stall (Torque limit) (V/f constant, <F170>, <F171>, <F172>, <F182>, <F185>, <F500>, <F501>, <F503>) <tHrA> (not <F182>) when <F632> = "2", "3" OFF: No.1 motor setting + No.1 Acc/Dec + No. 1 Stall (Torque limit) (<Pt>, <vL>, <vLv>, <vb>, <tHrA>, <ACC>, <dEC>, <F502>, <F601>)	[7. 2. 1]
154	155	PID3	External PID3 enabled	ON: External PID3 enabled	
156	157	PID4	External PID4 enabled	ON: External PID4 enabled	
158	159	RES2	Reset 2	ON: Reset accepted, ON -> OFF: Trip reset	
162	163	PID3R	External PID3 differential/integral reset	ON: External PID3 differential/integral reset	
164	165	PID3S	External PID3 plus/minus switching	ON: Plus/minus characteristics of <A340: PID control 3> setting OFF: Characteristics of <A340: PID control 3> setting	
170	171	PID4R	External PID4 differential/integral reset	ON: External PID4 differential/integral reset	
172	173	PID4S	External PID4 plus/minus switching	ON: Plus/minus characteristics of <A370: PID control 4> setting OFF: Characteristics of <A370: PID control 4> setting	
176	177	PMPR	Pump control release	ON: Pump release during pump control	
200	201	PWP	Parameter writing locked	ON: Parameter writing locked (Reading unlocked) OFF: <F700: Parameter reading & writing access lockout> setting	[6. 34. 1]
202	203	PRWP	Parameter reading locked	ON: Parameter reading & writing access lockout OFF: <F700: Parameter reading & writing access lockout> setting	[7. 2. 1]

# 11.9 Output terminal function

The function No. in the following table can be assigned to parameters <F130>, <F132>-<F134>, <F137>, <F138>, and <F159>-<F163>.

Function Number		Symbol	Function	Action	Reference
Positive logic	Negative logic				
0	1	LL	Lower limit frequency (LL)	ON: Output frequency over <LL: Lower limit frequency>	[7. 2. 2]
2	3	UL	Upper limit frequency (UL)	ON: Output frequency is <UL: Upper limit frequency> or more	[7. 2. 2]
4	5	LOW	Low-speed signal	ON: Output frequency is <F100: Low-speed signal output frequency> or more	[6. 1. 1] [7. 2. 2]
6	7	RCH	Acc/Dec completed	Output frequency is within command frequency $\pm$ <F102: Reach signal detection band>	[6. 1. 2] [7. 2. 2]
8	9	RCHF	Specified frequency attainment	ON: Output frequency is within <F101: Reach signal specified frequency> $\pm$ <F102: Reach signal detection band>	[6. 1. 3] [7. 2. 2]
10	11	FL1	Failure signal 1	ON: Tripped	[6. 30. 5] [6. 30. 6] [6. 30. 7] [6. 30. 8] [6. 30. 10] [7. 2. 2]
12	13	FL2	Failure signal 2	ON: At trip, except "EF", "OCL", "EPHO", and "OL2"	[7. 2. 2]
14	15	POC	Overcurrent (OC) pre-alarm	ON: Output current is <F601: Stall prevention level 1> or more	
16	17	POLI	Inverter overload (OL1) pre-alarm	ON: Calculated value of overload protection level is a specific level or more	
18	19	POLM	Motor overload (OL2) pre-alarm	ON: Calculated value of overload protection level is <F657: Overload alarm level> or more	
20	21	POH	Overheat (OH) pre-alarm	ON: Approx. 95°C or more of IGBT element OFF: Under approx. 95°C of IGBT element (90°C or less after detection is turned on)	
22	23	POP	Overvoltage (OP) pre-alarm	ON: Overvoltage limit in operation	
24	25	MOFF	Power circuit undervoltage (MOFF) alarm	ON: Main circuit undervoltage (MOFF) detected	
26	27	UC	Undercurrent (UC) alarm	ON: When the output current falls below the value set by <F611: Undercurrent detection level> and remains below <F611: Undercurrent detection level>+<F609: Undercurrent detection hysteresis> for the period of time specified by <F612: Undercurrent detection time> OFF: Output current is over <F611> (<F611>+<F609> or more after detection turns on)	[6. 30. 7] [7. 2. 2]
28	29	OT	Overtorque (OT) alarm	ON: When the torque becomes <F616: Overtorque detection level during power running> or more, and remains over <F616: Overtorque detection level during power running> - <F619: Overtorque detection hysteresis> for the time specified by <F618: Overtorque detection time> OFF: Torque is under <F616> (<F616>-<F619> or less after detection turns on)	[6. 30. 8] [7. 2. 2]
30	31	POLR	Braking resistor overload (OLr) pre-alarm	ON: 50% or more of calculated value of <F309: Braking resistor capacity> set overload protection level	[6. 15. 4] [7. 2. 2]

Function Number		Symbol	Function	Action	Reference
Positive logic	Negative logic				
32	33	E	Emergency off trip	ON: During emergency off trip ("E" is displayed)	[7. 2. 2]
34	35	RETRY	During retry	ON: During retry	
36	37	PTNS	Pattern operation end	ON: All pattern operation end	[6. 28] [7. 2. 2]
38	39	PIDL	PID deviation limit	ON: Within the setting value of <F364: PID1 deviation upper-limit>, <F365: PID1 deviation lower-limit>	[7. 2. 2]
40	41	RUN	Run/Stop	ON: During run or DC braking, OFF: During stop	
42	43	HFL	Serious failure	ON: At trip *1, OFF: Other than those trip above	
44	45	LFL	Slight failure	ON: At trip ("OC1", "OC2", "OC3", "OP1", "OP2", "OP3", "OH", "OL1", "OL2", "OL3", "OLr") OFF: Other than those trip above	
46	47	CPSW1	Commercial power/ Inverter Switching 1	ON: For inverter run	
48	49	CPSW2	Commercial power/ Inverter Switching 2	ON: For commercial power run	
50	51	FAN	During cooling fan run	ON: During cooling fan run	
52	53	JOG	During jog run	ON: During jog run	[7. 2. 2]
54	55	JBM	During terminal run	ON: During terminal run, OFF: Other than terminal run	[6. 30. 12] [7. 2. 2]
56	57	COT	Cumulative run time alarm	ON: Cumulative operation time is <F621: Cumulative run time alarm > or more	
58	59	COMOP	Communication option communication time-out	ON: Time-out of communication option occurs (held until reset)	[7. 2. 2]
60	61	FR	Fwd/Rev run	ON: During reverse run, OFF: During forward run * Command direction or OFF during stop	
62	63	RDY1	Ready for run 1	ON: Run when frequency command is ON	
64	65	RDY2	Ready for run 2	ON: Run when ST, RUN, or frequency command is ON	
68	69	BR	During brake	ON: Brake, OFF: Break release	
70	71	PAL	During alarm or pre-alarm	ON: Alarm or pre-alarm occurring	
72	73	FSL	During Fwd speed limit	ON: <F426: Fwd speed limit level> or more (Torque control)	
74	75	RSL	During Rev speed limit	ON: <F428: Rev speed limit level> or more (Torque control)	
76	77	HLTH	Inverter healthy output	Output while switching ON and OFF over at every 1 sec. (to check inverter soundness)	
78	79	COME	RS485 communication time-out	ON:RS485 communication time-out	
92	93	DATA1	Designated data bit 0	ON: bit0 of FA50 is ON, OFF: bit0 of FA50 is OFF	[7. 2. 2]
94	95	DATA2	Designated data bit 1	ON: bit1 of FA50 is ON, OFF: bit1 of FA50 is OFF	
106	107	LLD1	Light load detection 1	ON: Under heavy load torque(<F335> to <F338>)	
108	109	HLD	Heavy load detection	ON: Heavy load torque(<F335> to <F338>)or more	
110	111	PTL	During positive torque limit	ON: During positive torque limit	
112	113	MTL	During negative torque limit	ON: During negative torque limit	
114	115	RCRY	For external relay of rush current suppression	ON: For external relay of rush current suppression	
116	117	FL4	Failure signal 4	ON: During trip (including retry waite time)	

Function Number		Symbol	Function	Action	Reference
Positive logic	Negative logic				
118	119	STPC	Stop positioning completion	ON: Stop position completion	[7. 2. 2]
120	121	LLS	During sleep	ON: During sleep	
122	123	KEB	During synchronized Acc/Dec	ON: During synchronized acceleration/deceleration	
124	125	TVS	During traverse operation	ON: During traverse operation	
126	127	TVSD	During traverse Dec	ON: During traverse deceleration	
128	129	LTA	Parts replacement alarm	ON: Any one of cooling fan, control board capacitor, or power circuit capacitor reaches parts replacement time	[6. 30. 17] [7. 2. 2]
130	131	POT	Overtorque (OT) pre-alarm	ON: Torque current is 70% of <F616: Overtorque detection level during power running> setting value or more OFF: Torque current is under <F616> x 70%-<F619: Overtorque detection hysteresis>	[7. 2. 2]
132	133	FMOD	Frequency command 1/ Frequency command 2	ON: <F207: Frequency command select 2> enabled OFF: <FMOD: Frequency command select 1> enabled	
134	135	FL3	Failure signal 3	ON: During trip (except Emergency off)	
136	137	FLC	Hand/Auto	ON: Run command or panel run, OFF: Other than those at left	
138	139	FORCE	During forced run	ON: During forced run	[6. 31]
140	141	FIRE	During fire speed run	ON: During fire speed run	[7. 2. 2]
142	143	UTA	Undertorque alarm	ON: Undertorque alarm level or more	[7. 2. 2]
144	145	PIDF	PID1,2 frequency command agreement	ON: Frequency commanded by <F389: PID1 set value select > and <F360: PID1 feedback input select > are within ± <F374: PID1 set value agreement detection band>	
150	151	PTCA	PTC input pre-alarm	ON: PTC thermal input value is 60% of <F646: PTC detection resistance> or more	
152	153	STO	During Safe Torque Off (STO)	ON: Open between [STOA]-[STOB]-[PLC] OFF: Short circuit between [STOA]-[STOB]-[PLC]	[7. 2. 2]
154	155	DISK	Analog input disconnecting alarm	ON: The input value of terminal [II] is <F633: II analog input disconnection detection level> or less	
156	157	LI1	Terminal F ON/OFF	ON: Terminal [F] is ON, OFF: Terminal [F] is OFF	
158	159	LI2	Terminal R ON/OFF	ON: Terminal [R] is ON, OFF: Terminal [R] is OFF	
160	161	LTAF	Cooling fan replacement alarm	ON: Cooling fan reaches parts replacement time	[6. 30. 17] [7. 2. 2]
162	163	NSA	Number of starting alarm	ON: Number of starting is <F648: Number of starting alarm> or more	[6. 30. 21] [7. 2. 2]
164	165	LLD2	Light load detection 2	ON: Light load detection (compatible with old model)	[7. 2. 2]
166	167	DACC	During Acc	ON: During acceleration	
168	169	DDEC	During Dec	ON: During deceleration	
170	171	DRUN	During constant speed run	ON: During constant speed run	
172	173	DDC	During DC braking	ON: During DC braking	
174	175	HSTOP	During hit and stop	ON: During hit and stop	
176	177	SRVLR	During run including servo lock	ON: During run including servo lock	

Function Number		Symbol	Function	Action	Reference
Positive logic	Negative logic				
178	179	SRVL	During servo lock	ON: During servo lock	[7. 2. 2]
180	181	IPU	For input cumulative power	ON: Input cumulative power unit reach	
182	183	SMPA	Shock monitoring alarm	ON: Current / torque value reach the shock monitoring detection condition	
184	185	ENSA	Number of external equipment starting alarm	ON: Number of starting of external equipment is <F658: Number of external equipment starting alarm> or more	[6. 30. 21] [7. 2. 2]
186	187	VFS1	V/f switching status 1	ON: V/f switching status 1	[7. 2. 2]
188	189	VFS2	V/f switching status 2	ON: V/f switching status 2	
190	191	FAL	Cooling fan fault alarm	ON: Cooling fan fault	[6. 30. 11] [7. 2. 2]
192	193	ETHE	Embedded Ethernet communication time-out	ON: Embedded Ethernet communication time-out	[7. 2. 2]
194	195	CLD1	Calendar 1	ON: Calendar 1	
196	197	CLD2	Calendar 2	ON: Calendar 2	
198	199	CLD3	Calendar 3	ON: Calendar 3	
200	201	CLD4	Calendar 4	ON: Calendar 4	
202	203	PID2	During PID2 control	ON: During PID2 control	
204	205	PID3	During External PID3 control	ON: During External PID3 control	
206	207	PID3L	External PID3 deviation limit	ON: Within the setting value of <A346: PID3 deviation upper-limit>, <A347: PID3 deviation lower-limit>	
208	209	PID4	During External PID4 control	ON: During External PID4 control	
210	211	PID4L	External PID4 deviation limit	ON: Within the setting value of <A376: PID4 deviation upper-limit>, <A377: PID4 deviation lower-limit>	
212	213	PMPC	Pump control	ON: For pump operation	
222	223	MYF1	My function output 1	ON: My function output 1	
224	225	MYF2	My function output 2	ON: My function output 2	
226	227	MYF3	My function output 3	ON: My function output 3	
228	229	MYF4	My function output 4	ON: My function output 4	
230	231	MYF5	My function output 5	ON: My function output 5	
232	233	MYF6	My function output 6	ON: My function output 6	
234	235	MYF7	My function output 7	ON: My function output 7	
236	237	MYF8	My function output 8	ON: My function output 8	
238	239	MYF9	My function output 9	ON: My function output 9	
240	241	MYF10	My function output 10	ON: My function output 10	
242	243	MYF11	My function output 11	ON: My function output 11	
244	245	MYF12	My function output 12	ON: My function output 12	
246	247	MYF13	My function output 13	ON: My function output 13	
248	249	MYF14	My function output 14	ON: My function output 14	
250	251	MYF15	My function output 15	ON: My function output 15	
252	253	MYF16	My function output 16	ON: My function output 16	[7. 2. 2]
254	-	AOFF	Always OFF	Always OFF	-



Function Number		Symbol	Function	Action	Reference
Positive logic	Negative logic				
-	255	AON	Always ON	Always ON	-

\*1 At trip "OCL", "OCR", "EPH1", "EPH0", "Ot", "Ot2", "OtC3", "Utc3", "OH2", "E", "EEP1"- "EEP3", "Err2"- "Err5", "UC", "UP1", "Etn", "Etn1"- "Etn3", "EF2", "PrF", "EtyP", "E-13", "E-18"- "E-21", "E-23", "E-26", "E-32", "E-37", "E-39"

# 11. 10 Setup menu

Parameter title	Function	Mainly North America	Mainly Asia	Mainly Europe	China	Japan
FH	Maximum frequency (Hz)	80.0	80.0	80.0	50.0	80.0
F307	Supply voltage compensation	2	2	2	2	3
F319	Regenerative over-flux upper limit (%)	120	120	120	140	140
F417	Motor rated speed (min <sup>-1</sup> )	*1	*1	*1	*1	*1
vLv, F171, F175, F179	Base frequency Voltage (V)	230	230	230	200	200
		460	400	400	380	400
vL, UL, F170, F174, F178, F204, F213, F219, F225, F231, F237, F330, F335, F364, F367, F370, F426, F428, F814, A316, A319, A322, A346, A349, A352, A376, A379, A382	Frequency (Hz)	60.0	50.0	50.0	50.0	60.0
F606, F643	Frequency (max of set value) (Hz)	60.0	50.0	50.0	50.0	60.0
F405	Motor rated Capacity (kW)	3.7	4.0	4.0	4.0	3.7
		0.4	0.4	0.4	0.4	0.37

\*1 Depending on the region and the capacity. Refer to [11. 6].

## 11. 11 Guidance function

Embedded Ethernet setting	
<AUF>=1	
C081-C096	Device name 1-16
C610	Emb Eth. IP setting mode
C611-C614	Emb Eth. IP address setting value
C615-C618	Emb Eth. Subnet mask setting value
C619-C622	Emb Eth. Default gateway setting value
C629-C632	Emb Eth. IP address monitor
C633-C636	Emb Eth. Subnet mask monitor
C637-C640	Emb Eth. Default gateway monitor
Preset speed operation	
<AUF>=2	
CMOd	Run command select
FMOd	Frequency command select
ACC	Acceleration time 1
dEC	Deceleration time 1
FH	Maximum frequency
UL	Upper limit frequency
Sr1-Sr7	Preset speed 1-7
F111-F116	Terminal xx function
F287-F294	Preset speed 8-15
Analog frequency command	
<AUF>=3	
CMOd	Command mode selection
FMOd	Frequency mode selection
ACC	Acceleration time 1
dEC	Deceleration time 1
FH	Maximum frequency
UL	Upper limit frequency
LL	Lower limit frequency
F201	RR point 1 input value
F202	RR point 1 frequency
F203	RR point 2 input value
F204	RR point 2 frequency
F216	II point 1 input value
F217	II point 1 frequency
F218	II point 2 input value
F219	II point 2 frequency

Motor 1,2 switching	
<AUF>=4	
vL	Base frequency
vLv	Base frequency voltage 1
vb	Manual torque boost
tHrA	Motor overload protection current 1
ACC	Acceleration time 1
dEC	Deceleration time 1
F111-F116	Terminal xx function
F170	Base frequency 2
F171	Base frequency voltage 2
F172	Manual torque boost 2
F182	Motor overload protection current 2
F185	Stall prevention level 2
F415	Motor rated current
F500	Acceleration time 2
F501	Deceleration time 2
F601	Stall prevention level 1
Motor parameter	
<AUF>=5	
Pt	V/f pattern
vL	Base frequency
vLv	Base frequency voltage 1
F405	Motor rated capacity
F415	Motor rated current
F417	Motor rated speed
F400	Offline auto-tuning
PM motor parameter	
<AUF>=6	
Pt	Motor control type
vL	Motor base frequency
vLv	Motor nominal voltage
F400	Auto tuning
F402	Automatic torque boost
F405	Motor rated capacity
F415	Motor nominal current
F417	Motor nominal speed
F458	Current control P gain
F460	Speed loop P gain
F461	Speed loop I gain
F462	Load inertia
F910	Step-out detection current
F911	Step-out detection time
F912	Auto tune Lq axis
F913	Auto tune Ld axis
F914	Current stall prevention frequency
F915	Starting method
F916	Id current at starting
F917	Lq ratio at 100% load
F918	Lq ratio at 200% load
F919	Reluctance torque ratio



# 12 Specifications

I

II

In this chapter, the inverter's model and type, standard specification, outside dimensions, and approx. mass are described.

## 12.1 Model and main standard specification

### ■ Standard specification depending on model

< 240 V class: HD rating >

Item		Specification														
Voltage class		240 V class														
Frame size		A1				A2	A3		A4			A5			A6	
Applicable motor (kW)		0.4	0.75	1.5	2.2	4.0	5.5	7.5	11	15	18.5	22	30	37	45	55
Applicable motor (HP)		0.5	1	2	3	5	7.5	10	15	20	25	30	40	50	60	75
Rating	Type	VFAS3-														
	Form	2004P	2007P	2015P	2022P	2037P	2055P	2075P	2110P	2150P	2185P	2220P	2300P	2370P	2450P	2550P
	Output capacity (kVA) *1	1.3	1.8	3.0	4.3	7.1	9.7	12.5	17.8	24.2	29.9	35.3	46.9	56.8	67.1	80.4
	Output current (A) *2	3.3	4.6	8.0	11.2	18.7	25.4	32.7	46.8	63.4	78.4	92.6	123	149	176	211
	Output voltage	3-phase 200 V to 240 V (The maximum output voltage is equal to the input supply voltage)														
	Overload current rating	150%-1 minute, 180%-2 s														
Electrical braking	Dynamic braking circuit	Built-in													Optional	
	Dynamic braking resistor	External braking resistor (Optional)														
Power supply	Voltage-frequency	3-phase 200 V to 240 V - 50/60 Hz														
	Allowable fluctuation	Voltage 170 V to 264 V *3, Frequency $\pm 5\%$														
	Required power supply capacity (kVA) *4	0.7	1.4	2.4	3.7	5.9	7.7	10.5	15.7	20.6	24.9	30.7	40.5	49.6	61.0	73.3
Degree of protection (IEC60529)		IP20												IP00		
Cooling method		Forced air-cooled														
Cooling fan noise (dBA) (Reference value) *5		58				54	60	64			63			70		
Color		RAL7016 / RAL7035														
EMC filter		No EMC filter														
DC reactor		Built-in														
UL type1 kit		Built-in													Optional	

\*1 Capacity is calculated at 220 V for the 240 V class.

\*2 Indicates rated output current when setting <F300: Carrier frequency> into 4 kHz for frame size A1 to A5, 2.5 kHz for frame size A6.

\*3 Lower limit of voltage for 240 V class is 180 V when the inverter is used continuously (load of 100%).

\*4 Required power supply capacity varies with the value of the power supply side inverter impedance (including those of the input reactor and wires).

\*5 These acoustic noise values are not guaranteed because they are just reference values.

1

2

3

4

5

6

7

8

9

10

11

12

13

14

15

16

< 240 V class: ND rating >

Item		Specification														
Voltage class		240 V class														
Frame size		A1				A2	A3		A4			A5			A6	
Applicable motor (kW)		0.75	1.5	2.2	4.0	5.5	7.5	11	15	18.5	22	30	37	45	55	75
Applicable motor (HP)		1	2	3	5	7.5	10	15	20	25	30	40	50	60	75	100
Rating	Type	VFAS3-														
	Form	2004P	2007P	2015P	2022P	2037P	2055P	2075P	2110P	2150P	2185P	2220P	2300P	2370P	2450P	2550P
	Output capacity (kVA) <sup>*1</sup>	1.8	3.0	4.3	7.1	9.7	12.5	17.8	24.2	29.9	35.3	46.9	56.8	67.1	80.4	107
	Output current (A) <sup>*2</sup>	4.6	8.0	11.2	18.7	25.4	32.7	46.8	63.4	78.4	92.6	123	149	176	211	282
	Output voltage	3-phase 200 V to 240 V (The maximum output voltage is equal to the input supply voltage)														
	Overload current rating	120%-1 minute, 135%-2 s														
Electrical braking	Dynamic braking circuit	Built-in												Optional		
	Dynamic braking resistor	External braking resistor (Optional)														
Power supply	Voltage-frequency	3-phase 200 V to 240 V - 50/60 Hz														
	Allowable fluctuation	Voltage 170 V to 264 V <sup>*3</sup> , Frequency $\pm 5\%$														
	Required power supply capacity (kVA) <sup>*4</sup>	1.2	2.3	3.3	5.9	7.8	10.3	15.0	20.6	24.9	29.4	40.5	49.3	59.6	73.3	98.1
Degree of protection (IEC60529)		IP20												IP00		
Cooling method		Forced air-cooled														
Cooling fan noise (dBA) (Reference value) <sup>*5</sup>		58				54	60		64			63			70	
Color		RAL7016 / RAL7035														
EMC filter		No EMC filter														
DC reactor		Built-in														
UL type1 kit		Built-in												Optional		

\*1 Capacity is calculated at 220 V for the 240 V class.

\*2 Indicates rated output current when setting <F300: Carrier frequency> into 4 kHz for frame size A1 to A5, 2.5 kHz for frame size A6.

\*3 Lower limit of voltage for 240 V class is 180 V when the inverter is used continuously (load of 100%).

\*4 Required power supply capacity varies with the value of the power supply side inverter impedance (including those of the input reactor and wires).

\*5 These acoustic noise values are not guaranteed because they are just reference values.

< 480 V class: HD rating >

Item		Specification												
Voltage class		480 V class												
Frame size		A1					A2		A3			A4		
Applicable motor (kW)		0.4	0.75	1.5	2.2	4.0	5.5	7.5	11	15	18.5	22	30	37
Applicable motor (HP)		0.5	1	2	3	5	7.5	10	15	20	25	30	40	50
Rating	Type	VFAS3-												
	Form	4004PC	4007PC	4015PC	4022PC	4037PC	4055PC	4075PC	4110PC	4150PC	4185PC	4220PC	4300PC	4370PC
	Output capacity (kVA) <sup>*1</sup>	1.1	1.7	3.0	4.3	7.1	9.7	12.6	17.9	24.2	29.9	35.3	46.9	56.8
	Output current (A) <sup>*2</sup>	1.5	2.2	4.0	5.6	9.3	12.7	16.5	23.5	31.7	39.2	46.3	61.5	74.5
	Output voltage	3-phase 380 V to 480 V (The maximum output voltage is equal to the input supply voltage)												
	Overload current rating	150%-1 minute, 180%-2 s												
Electrical braking	Dynamic braking circuit	Built-in												
	Dynamic braking resistor	External braking resistor (Optional)												
Power supply	Voltage-frequency	3-phase 380 V to 480 V - 50/60 Hz												
	Allowable fluctuation	Voltage 323V to 528V <sup>*3</sup> , Frequency $\pm$ 5%												
	Required power supply capacity (kVA) <sup>*4</sup>	0.7	1.4	2.6	3.9	6.6	8.5	11.4	16.6	22.3	27.3	32.7	44.3	53.9
Degree of protection (IEC60529)		IP20												
Cooling method		Forced air-cooled												
Cooling fan noise (dBA) (Reference value) <sup>*5</sup>		58					54		60			64		
Color		RAL7016 / RAL7035												
EMC filter		Built-in												
DC reactor		Built-in												
UL type1 kit		Built-in												

Item		Specification									
Voltage class		480 V class									
Frame size		A5			A6			A7	A8		
Applicable motor (kW)		45	55	75	90	110	132	160	200	220	280
Applicable motor (HP)		60	75	100	125	150	200	250	300	350	450
Rating	Type	VFAS3-									
	Form	4450PC	4550PC	4750PC	4900PC	4110KPC	4132KPC	4160KPC	4200KPC	4220KPC	4280KPC
	Output capacity (kVA) *1	67.1	80.8	111	132	161	191	239	295	325	419
	Output current (A) *2	88.0	106	145	173	211	250	314	387	427	550
	Output voltage	3-phase 380 V to 480 V (The maximum output voltage is equal to the input supply voltage)									
	Overload current rating	150%-1 minute, 180%-2 s						150%-1 minute, 165%-2s			
Electrical braking	Dynamic braking circuit	Built-in			Optional			Built-in	Optional		
	Dynamic braking resistor	External braking resistor (Optional)									
Power supply	Voltage-frequency	3-phase 380 V to 480 V - 50/60 Hz						3-phase 380 to 440 V - 50 Hz, 3-phase 380 to 480 V - 60 Hz			
	Allowable fluctuation	Voltage 323 V to 528 V *3, Frequency $\pm$ 5%						Voltage 323 to 484 V - 50 Hz, 323 V to 528 V - 60 Hz *3, Frequency $\pm$ 5%			
	Required power supply capacity (kVA) *4	65.6	79.5	108	133	155	181	225	275	308	379
Degree of protection (IEC60529)		IP20			IP00						
Cooling method		Forced air-cooled									
Cooling fan noise (dBA) (Reference value) *5		63			70			73	76		
Color		RAL7016 / RAL7035									
EMC filter		Built-in									
DC reactor		Built-in						Attached			
UL type1 kit		Built-in			Optional			-			

\*1. Capacity is calculated at 440 V for the 480 V class.

\*2. Indicates rated output current when setting <F300: Carrier frequency> into 4 kHz for frame size A1 to A5, 2.5 kHz for frame size A6 to A8.

\*3. Lower limit of voltage for 480 V class is 342 V when the inverter is used continuously (load of 100%).

\*4. Required power supply capacity varies with the value of the power supply side inverter impedance (including those of the input reactor and wires).

\*5. These acoustic noise values are not guaranteed because they are just reference values.



< 480V class: ND rating >

Item		Specification												
Voltage class		480V class												
Frame size		A1					A2		A3			A4		
Applicable motor (kW)		0.75	1.5	2.2	4.0	5.5	7.5	11	15	18.5	22	30	37	45
Applicable motor (HP)		1	2	3	5	7.5	10	15	20	25	30	40	50	60
Rating	Type	VFAS3-												
	Form	4004PC	4007PC	4015PC	4022PC	4037PC	4055PC	4075PC	4110PC	4150PC	4185PC	4220PC	4300PC	4370PC
	Output capacity (kVA) <sup>*1</sup>	1.7	3.0	4.3	7.1	9.7	12.6	17.9	24.2	29.9	35.3	46.9	56.8	67.1
	Output current (A) <sup>*2</sup>	2.2	4.0	5.6	9.3	12.7	16.5	23.5	31.7	39.2	46.3	61.5	74.5	88.0
	Output voltage	3-phase 380 V to 480 V (The maximum output voltage is equal to the input supply voltage)												
	Overload current rating	120%-1 minute, 135%-2 s												
Electrical braking	Dynamic braking circuit	Built-in												
	Dynamic braking resistor	External braking resistor (Optional)												
Power supply	Voltage-frequency	3-phase 380 V to 480 V - 50/60 Hz												
	Allowable fluctuation	Voltage 323 V to 528 V <sup>*3</sup> , Frequency $\pm$ 5%												
	Required power supply capacity (kVA) <sup>*4</sup>	1.2	2.4	3.4	6.1	8.3	10.9	15.6	21.3	26.4	31.4	42.0	52.4	63.2
Degree of protection (IEC60529)		IP20												
Cooling method		Forced air-cooled												
Cooling fan noise (dBA) (Reference value) <sup>*5</sup>		58					54		60			64		
Color		RAL7016 / RAL7035												
EMC filter		Built-in												
DC reactor		Built-in												
UL type1 kit		Built-in												

Item		Specification									
Voltage class		480 V class									
Frame size		A5			A6			A7	A8		
Applicable motor (kW)		55	75	90	110	132	160	220	250	280	315
Applicable motor (HP)		75	100	125	150	200	250	350	400	450	500
Rating	Type	VFAS3-									
	Form	4450PC	4550PC	4750PC	4900PC	4110KPC	4132KPC	4160KPC	4200KPC	4220KPC	4280KPC
	Output capacity (kVA) <sup>*1</sup>	80.8	111	132	161	191	230	325	367	419	469
	Output current (A) <sup>*2</sup>	106	145	173	211	250	302	427	481	550	616
	Output voltage	3-phase 380 V to 480 V (The maximum output voltage is equal to the input supply voltage)									
	Overload current rating	120%-1 minute, 135%-2 s									
Electrical braking	Dynamic braking circuit	Built-in			Optional			Built-in	Optional		
	Dynamic braking resistor	External braking resistor (Optional)									
Power supply	Voltage-frequency	3-phase 380 V to 480 V - 50/60 Hz						3-phase 380 to 440 V - 50 Hz, 3-phase 380 to 480 V - 60 Hz			
	Allowable fluctuation	Voltage 323 V to 528 V <sup>*3</sup> , Frequency $\pm$ 5%						Voltage 323 to 484 V - 50 Hz, 323 V to 528 V - 60 Hz <sup>*3</sup> , Frequency $\pm$ 5%			
	Required power supply capacity (kVA) <sup>*4</sup>	77.0	103	125	155	181	214	296	335	379	422
Degree of protection (IEC60529)		IP20			IP00						
Cooling method		Forced air-cooled									
Cooling fan noise (dBA) (Reference value) <sup>*5</sup>		63			70			73	76		
Color		RAL7016 / RAL7035									
EMC filter		Built-in									
DC reactor		Built-in						Attached			
UL type1 kit		Built-in			Optional			-			

\*1. Capacity is calculated at 440 V for the 480 V class.

\*2. Indicates rated output current when setting <F300: Carrier frequency> into 4 kHz for frame size A1 to A5, 2.5 kHz for frame size A6 to A8.

\*3. Lower limit of voltage for 480 V class is 342 V when the inverter is used continuously (load of 100%).

\*4. Required power supply capacity varies with the value of the power supply side inverter impedance (including those of the input reactor and wires).

\*5. These acoustic noise values are not guaranteed because they are just reference values.

■ Common specification

Item		Specification
Control specification	Control system	Sinusoidal PWM control
	Output voltage adjustment	Adjustable within the range of 50 - 330 V (240 V class) and 50 - 660 V (480 V class) by correcting the supply voltage
	Output frequency range	Setting between 0.01 - 590 Hz. Default frequency is set to 0.01-50/60 Hz. Maximum frequency adjustment (30 to 590Hz)
	Minimum setting steps of frequency	0.01 Hz: operation panel input (60 Hz base), 0.03 Hz: analog input (60 Hz base, 11 bit/0 - 10 Vdc)
	Frequency accuracy	Analog input: $\pm 0.2\%$ of the maximum output frequency (at $25\pm 10^\circ\text{C}$ ) Digital input: $\pm 0.01\% \pm 0.022$ Hz of the output frequency
	Voltage/frequency characteristics	V/f constant, variable torque, automatic torque boost, vector control, base frequency adjustment 1, 2, 3, and 4 (15 - 590 Hz), V/f 5-point arbitrary setting, torque boost adjustment (0 - 30%), start frequency adjustment (0 - 10 Hz), stop frequency adjustment (0 - 30 Hz)
	Frequency setting signal	3 k $\Omega$ potentiometer (possible to connect to 1 - 10 k $\Omega$ -rated potentiometer) 0 - 10Vdc (input impedance Zin: 31.5 k $\Omega$ ) -10 to +10 Vdc (Zin: 31.5 k $\Omega$ ) 4 - 20 mAdc (Zin: 250 $\Omega$ )
	Terminal block frequency command	The characteristic can be set arbitrarily by two-point setting. Compliant with 7 types of input; analog input (RR, RX, II, AI4, AI5), and pulse input (S4, S5)
	Frequency jump	Three frequency can be set. Setting of jump frequency and width.
	Upper and lower limit frequencies	Upper limit frequency: 0 to max. frequency, lower limit frequency: 0 to upper limit frequency
	PWM carrier frequency	Frame size A1 to A4: adjustable between 1.0 - 16 kHz Frame size A5 to A8: adjustable between 2.5 - 8 kHz
	PID control	Adjustment of proportional gain, integral time, differential time and delay filter. Multi PID and external PID control.
	Torque control	Voltage command input specification: -10 - +10 Vdc
	Real time clock	Current time (Year, month, date, hour, minute), Timezone, Daylight saving time, 4 working days and 20 holidays can be set by parameters.
Operation specifications	Acceleration/deceleration time	0.01 - 6000 sec. Selectable from among acceleration/deceleration, times 1, 2, 3 and 4. Automatic acceleration/ deceleration function. S-pattern acceleration/deceleration 1 and 2 pattern adjustable.
	DC braking	Adjustment of braking start frequency (0 - <FH>Hz), braking (0 - 100%) and braking time (0 - 25.5 sec.). With emergency off braking function and motor shaft fix control function.
	Forward run/reverse run *1	Forward run with ON of the terminal [F], Reverse run with ON of the terminal [R] (Default setting). Coast stop with OFF of the terminal assigned Stad-by function. Emergency off by panel operation or terminal.
	Jog run *1	Jog run, if selected, allows jog operation from the operation panel Jog run operation by terminal block is possible by setting the parameters.
	Preset speed operation *1	By changing the combination of the terminals [S1], [S2], [S3], [S4], [S5] set frequency + 31-speed operation. Selectable between acceleration/deceleration time, torque limit and V/f by set frequency.
	Retry	Capable of restarting after a check of the power circuit elements in case the protective function is activated. Max. 10 times selectable arbitrarily. Waiting time adjustment (0 - 10 sec.)
	Soft stall	Automatic load reduction control at overloading. (Default: OFF)
	Cooling fan ON/OFF	The cooling fan will be stopped automatically to assure long life when unnecessary.
	Operation panel key operation ON/OFF control	Key lock selectable between STOP key only, MODE key only, etc. All key operations can be locked.
	Regenerative power ride-through control	Possible to keep the motor running using its regenerative energy in case of a momentary power failure. (Default: OFF)
	Auto-restart operation	Possible to restart the motor in coasting in accordance with its speed and direction. (Default: OFF)
	Simplified pattern operation	Possible to select each 8 patterns in 2 groups from 15-speed operation frequency. Max. 16 types of operation possible. Terminal operation/repeat operation possible.
	Commercial inverter switching	Possible to switch operation by commercial power supply or inverter
	Light-load high-speed operation	Increases the operating efficiency of the machine by increasing the rotational speed of the motor when it is operated under light load.
	Droop function	When two or more inverters are used to operate a single load, this function prevents load from concentrating on one inverter due to unbalance.
	Override function	External input signal adjustment is possible to the operation frequency command value.
Protective function	Protective function	Stall prevention, current limit, overcurrent, overvoltage, short circuit on the load side, ground fault on the load side *5, undervoltage, momentary power failure (15 ms or more), non-stop control at momentary power failure, overload protection, arm overload at starting, overcurrent on the load side at starting, overcurrent and overload at braking resistor, overheat, emergency off
	Electronic thermal characteristic	Switchable between standard motor/constant torque motor, adjustment of overload protection and stall prevention level.
	Reset	Reset by 1a contact closed (or 1b contact opened), or by operation panel. Or power supply OFF/ON. This function is also used to save and clear trip records.

(Continued overleaf)

(Continued)

Item		Specification	
Display function	Screen of LCD	Alarms	Stall prevention during run, overload limit, overload, undervoltage on power supply side, DC circuit undervoltage, setting error, in retry, upper limit, lower limit.
		Causes of failures	Overcurrent, overvoltage, overheat, short circuit on the load side, ground fault on the load side, inverter overload, arm overcurrent at starting, overcurrent on the load side at starting, cooling fan fault, CPU fault, EEPROM fault, RAM fault, ROM fault, communication error, (braking resistor overcurrent/overload), (emergency off), (undervoltage), (undercurrent), (overtorque), (motor overload), (input phase failure), (output phase failure) The items in the parentheses are selectable.
		Monitoring function	Output frequency, frequency command, forward run/reverse run, output current, DC voltage, output voltage, compensated frequency, terminal input/output information, CPU version, past trip history, cumulative operation time, feedback frequency, torque, torque command, torque current, exiting current, PID feedback value, motor overload factor, inverter overload factor, PBR overload factor, PBR load factor, input power, output power, peak output current, peak DC voltage, RR input, II input, RX input, AI4 input, AI5 input, FM output, AM output, expansion I/O card option CPU version, integral input power, integral output power, communication option reception counter, communication option abnormal counter.
		Free unit display	Display of optional units other than output frequency (motor speed, line speed, etc), current ampere/% switch, voltage volt/% switch
		Automatic edit function	Searches automatically parameters that are different from the default setting parameters. Easy to find changed parameters.
		User default setting	User parameter settings can be saved as default settings. Allows to reset the parameters to the user-defined parameter settings.
LED	Charge display	Displays power circuit capacitor charging.	
Input/output terminal logic function		Possible to select positive logic or negative logic with programmable input/output terminal function menu. 2 or 3 function can be assigned for some terminals. *1 *2 (Default setting: positive logic)	
Sink/source switching		Possible to switch between minus common (CC) and plus common (P24) for digital input terminal. (Default setting: external power supply)	
output signal	Failure detection signal	1c contact output (250 Vac-2 A-(cosΦ=1), 30Vac-2A(Resistive), 250Vac-1A-(cosΦ=0.4), 30Vdc-1A(L/R=7ms))	
	Relay output	2×1a contact output (250 Vac-2 A-(cosΦ=1), 30Vac-2A(Resistive), 250Vac-1A-(cosΦ=0.4), 30Vdc-1A(L/R=7ms))	
	Low speed/speed reach signal output *2	Digital output (24 Vdc, max. 50 mA)	
	Output for frequency meter/ Output for ammeter *3	Analog output for meter: 1 mA dc full-scale dc ammeter 0 - 20 mA (4 - 20 mA) output: DC ammeter (allowable load resistance: 500 Ω or less) 0 - 10 V output: DC voltmeter (allowable load resistance: 1 kΩ or more)	
	Pulse train frequency output	Pulse train output (Up to 30 kpps, duty 50%)	
Communication function		Standard equipment: Ethernet (dual port with switch, IEEE802.3/IEEE802.3u : Fast Ethernet, 10/100Mbps: Auto negotiation), RS485 (2-channel) Optional: PROFINET, DeviceNet, PROFIBUS-DP	
Environments	Use environments	Indoor use. Place not exposed to direct sunlight and free of corrosive and explosive gases.	
	Ambient temperature	-15 to 60°C *4 Frame size A1 to A5: Current reduction, remove the top cover when above 50°C Frame size A6: Current reduction when above 50°C Frame size A7 and A8: Current reduction when above 50°C(HD), above 45°C(ND)	
	Storage temperature	-25 to +70°C (Temperature applicable for a short term.)	
	Relative humidity	5 to 95% (free from condensation)	
	Altitude	4800m or less for TN/TT system (Frame size A1 to A6) 3800m or less for IT system (Frame size A1 to A6) 3000m or less for TN/TT/IT system (Frame size A7 and A8) 2000m or less for corner-earthed system (All frame size) (current reduction necessary if above 1000 m for all frame size)	
	Vibration	5.9 m/s <sup>2</sup> (0.6G) or less (10 - 55 Hz) *6	

\*1: 14 digital input terminals (of which 6 are options) are programmable digital input terminals, and they make it possible to arbitrarily select from 178 types of signals.

\*2: Programmable digital/pulse train output terminal make it possible to arbitrarily select from 256 types of signals.

\*3: Programmable analog output terminals make it possible to arbitrarily select from 54 types of signals.

\*4: -10 to 60°C for frame size A7 and A8.

Remove operation panel of the inverter when above 50°C.

For detail of current reduction, see "Instruction manual for load reduction" (E6582116)

\*5: This function protects inverters from overcurrent due to output circuit ground fault.

\*6: 2.9m/s<sup>2</sup> {0.3G} or less (10-55Hz) for frame size A6 to A8.

# 12.2 Outside and Mass

## ■ Outside dimensions and mass

Input voltage Class	Applicable motor capacity (kW)	Inverter type		Dimension (mm)					Frame Size	Approx. mass (kg)
				W	H	D	W1 *1	H1 *1		
3-phase 240 V	0.4	VFAS3-	2004P	130	326	202	102	263	A1	4.3
	0.75		2007P							4.3
	1.5		2015P							4.5
	2.2		2022P							4.6
	4.0		2037P	155	391.5	231	125	324	A2	7.7
	5.5		2055P	195	534.5	232	168	460	A3	13.8
	7.5		2075P							13.8
	11		2110P	210	660	268	174	570	A4	27.3
	15		2150P							27.3
	18.5		2185P							27.3
	22		2220P	265	908	313	220	718	A5	57.6
	30		2300P							57.6
	37		2370P							57.6
	45		2450P	300	850	383	255	820	A6	82
	55		2550P							82
3-phase 480 V	0.4	VFAS3-	4004PC	130	326	202	102	263	A1	4.5
	0.75		4007PC							4.5
	1.5		4015PC							4.5
	2.2		4022PC							4.6
	4.0		4037PC							4.7
	5.5		4055PC							155
	7.5		4075PC	7.7						
	11		4110PC	195	534.5	232	168	460	A3	13.6
	15		4150PC							14.2
	18.5		4185PC							14.3
	22		4220PC	210	660	268	174	570	A4	28
	30		4300PC							28.2
	37		4370PC							28.7
	45		4450PC	265	908	313	220	718	A5	57.5
	55		4550PC							59
	75		4750PC							59.5
	90		4900PC	300	850	383	255	820	A6	82
	110		4110KPC							82
	132		4132KPC							82
	160		4160KPC	430	1190	377	350	920	A7	110 (168)*2
	200		4200KPC	585	1190	377	540	920	A8	138 (200)*2
	220		4220KPC							140 (210)*2
280	4280KPC	140 (210)*2								

\*1 W1 and H1 are the mounting dimensions of the inverter.

\*2 Value in ( ) includes attached DC reactor.

■ Outline drawing

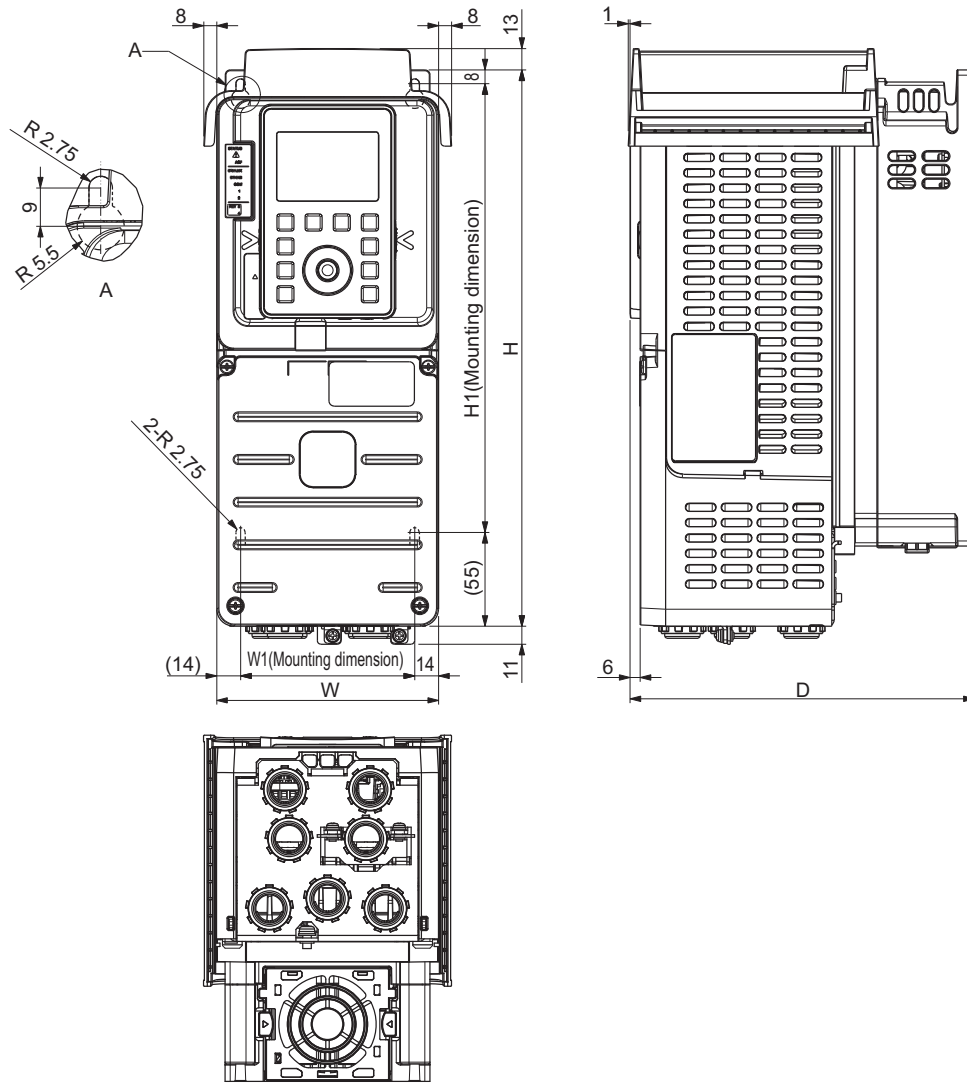

Frame size A1

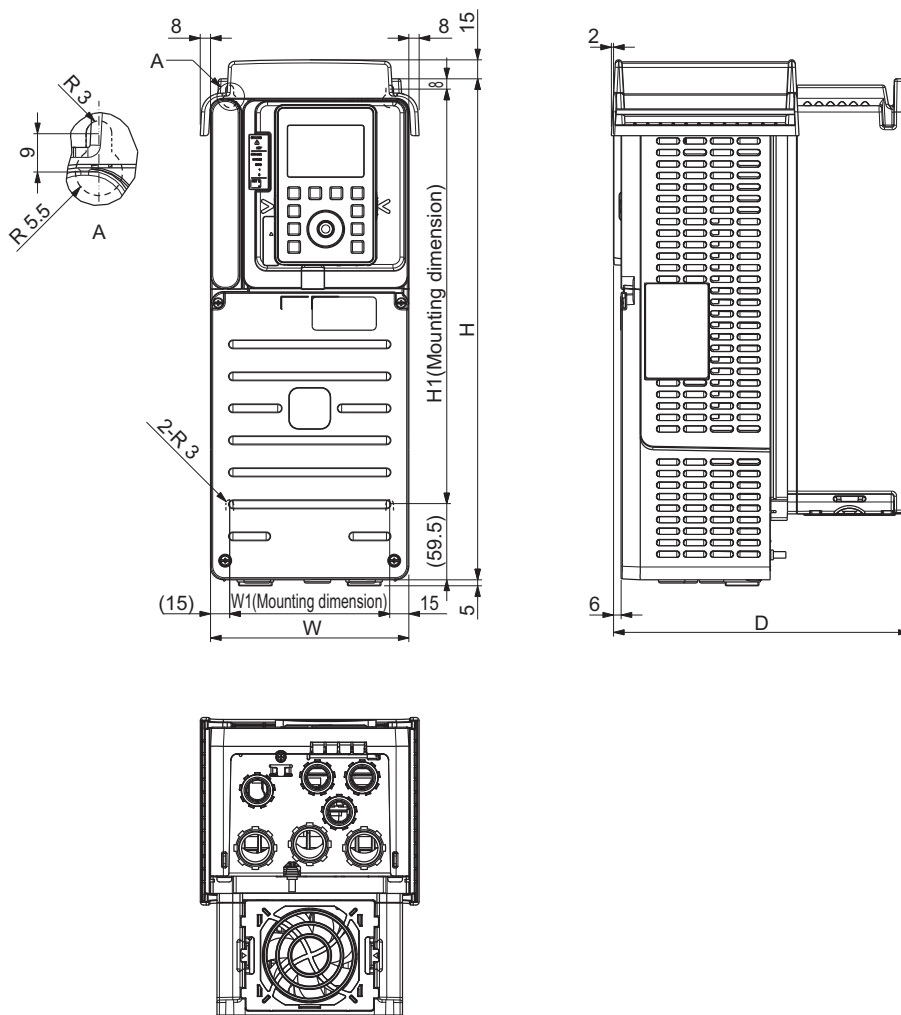

Frame size A2

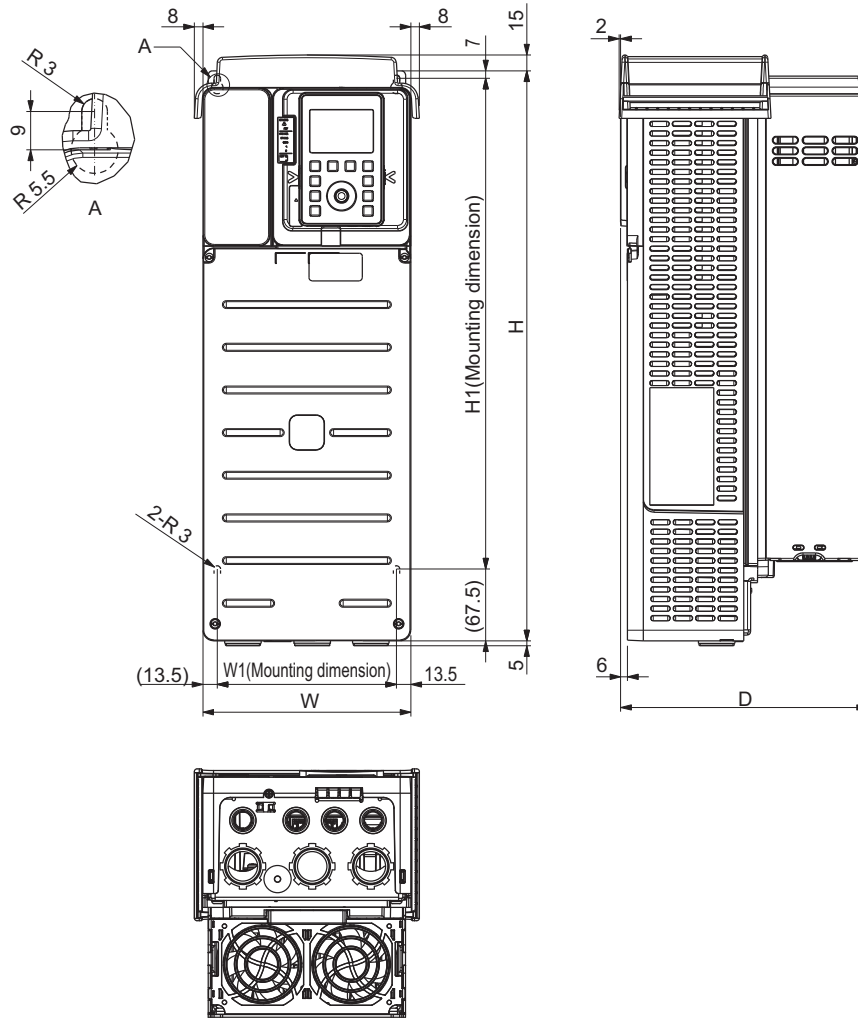

Frame size A3



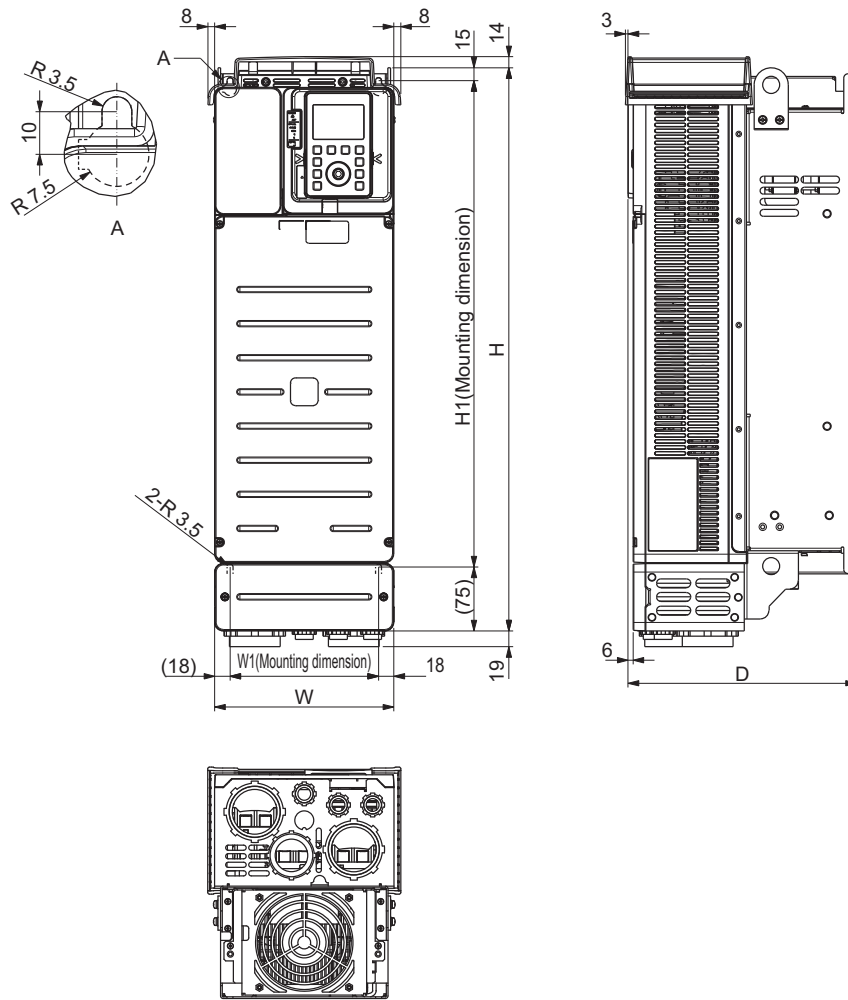

Frame size A4

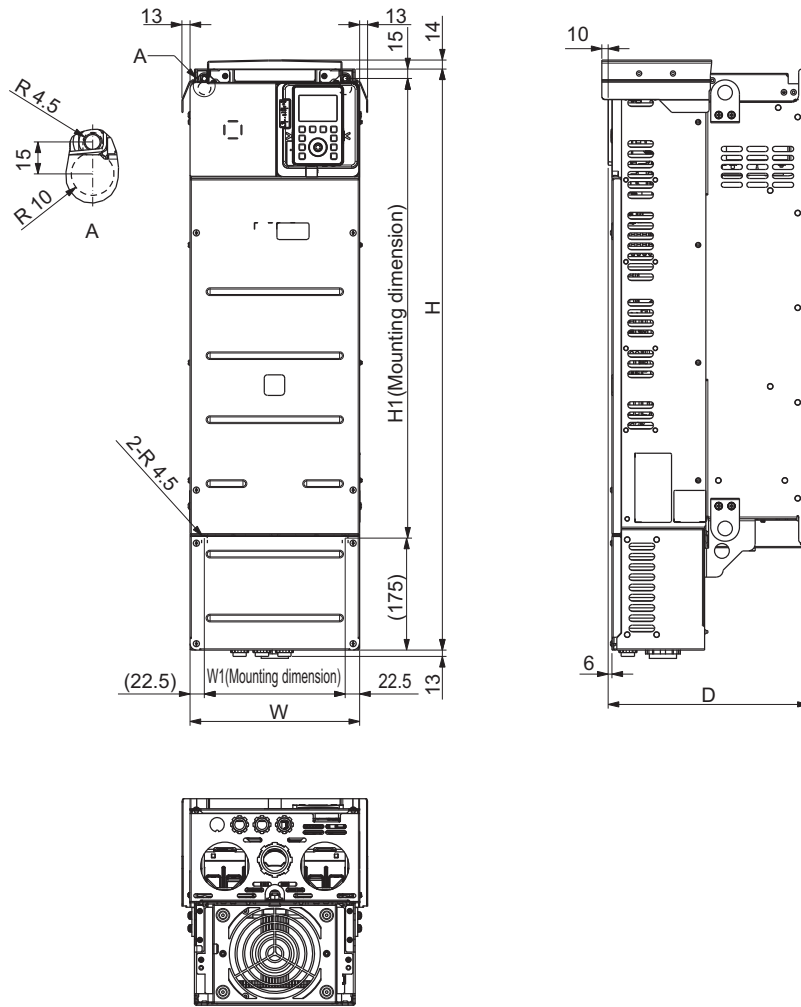

Frame size A5

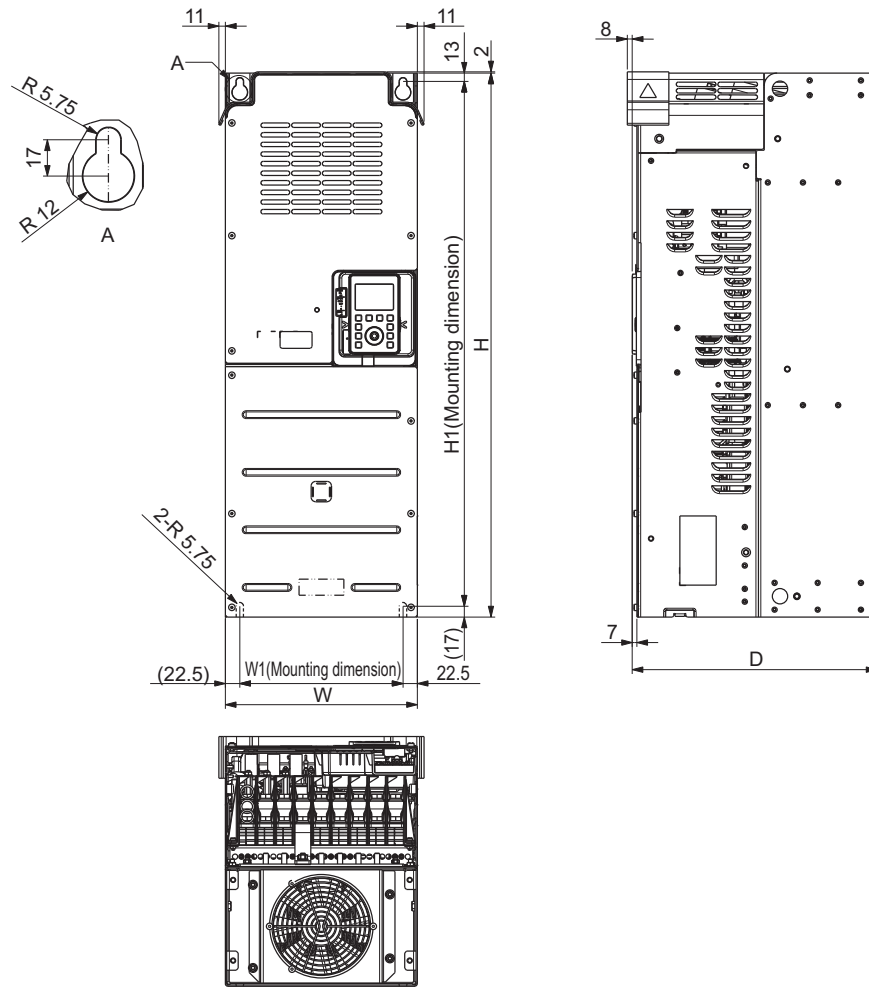

Frame size A6

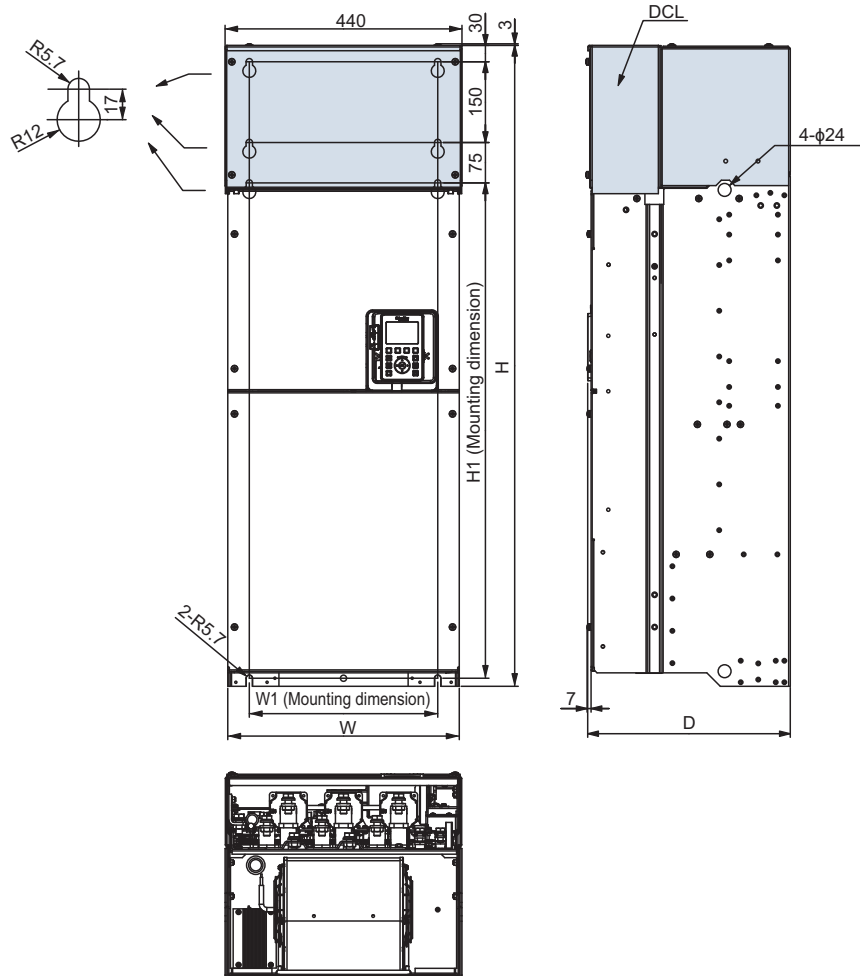

Frame size A7

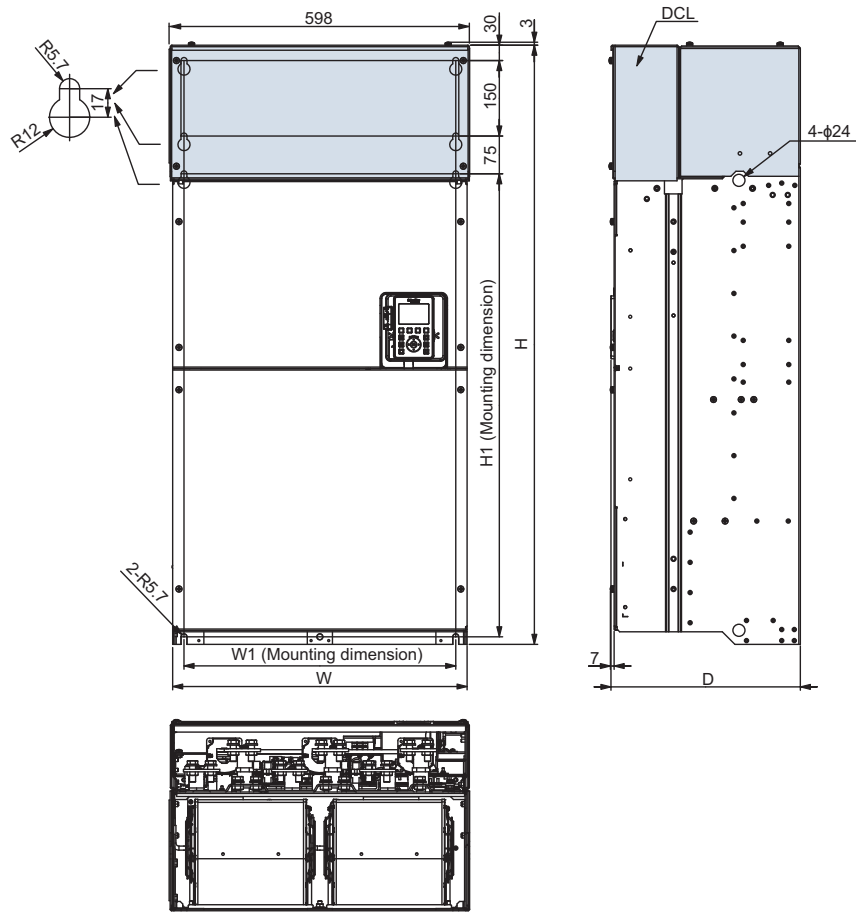

Frame size A8



# 13 | Trip information and measures

I

II

## 13.1 Description of trip and alarm information and measures

1

2

3

4

5

6

7

8

9

10

11

12

13

14

15

16

If a trip occurs, make failure diagnosis according to the table below before contacting your Toshiba distributor.

### ■ Term description

Trip	Output of the inverter is turned OFF for protection of the inverter or external equipment. A failure signal can be output if the output terminal function is assigned. (A failure signal is assigned to the terminal [FL] in the default setting).
Alarm	Indicates a condition that the inverter or external equipment may be damaged if continued. A signal can be output if the output terminal function is assigned. Under voltage, etc. are displayed with blinking on the operation panel.
Pre-alarm	A condition close to the trip level. A signal can be output when the output terminal function is assigned. "C", "P", "L", and "H" blink in the operation panel during run for overcurrent, overvoltage, overload, and overheat respectively.
Message	Informs a status of the inverter and setting error. It is not an alarm.

### ■ Trip information

Trip display	Failure code	Trip name	Detection factor	Measures
E	0011	Emergency off	Emergency off is input. 1) When a run command is other than the operation panel, [STOP/RESET] key was pressed twice. 2) A signal was input to the input terminal in which emergency off is assigned. 3) Emergency off is input from communication.	<ul style="list-style-type: none"> <li>Reset after solving problems.</li> <li>Clear the emergency off signal.</li> </ul>
E-11	002B	Brake answer error *	The system does not reply even after the setting time in <F630: Brake answer wait time> elapsed.	<ul style="list-style-type: none"> <li>Check the system.</li> <li>Check if the &lt;F630&gt; setting is correct. When not used, set &lt;F630&gt;="0.0: Disabled".</li> </ul>
E-12	002C	PG error	1) PG is disconnected. 2) Error exists in PG wiring. 3) PG voltage is improper.	<ul style="list-style-type: none"> <li>Check the PG wiring.</li> <li>Check if the PG settings are correct. &lt;F376: PG phases number select&gt;, &lt;F379: PG option voltage&gt;</li> </ul>

\*Enable/Disable can be selected for trip with a parameter.

Trip display	Failure code	Trip name	Detection factor	Measures
E-13	002D	Abnormal speed error	<p>1) When &lt;Pt: V/f Pattern&gt; = "0" to "9", an over speed condition occurred. Over speed condition: In case F623≠0.0, F624≠0.0, the condition which estimated frequency is not inside of "output frequency - &lt;F624&gt;" to "output frequency + &lt;F623&gt;" continues &lt;F622&gt; times.</p> <p>2) When &lt;Pt: V/f Pattern&gt; = "10" to "11", over speed continued by PG failure, etc. Over speed condition: In case F623≠0.0, F624≠0.0, the condition which measured frequency is not inside of "output frequency - &lt;F624&gt;" to "output frequency + &lt;F623&gt;" continues &lt;F622&gt; times.</p> <p>3) Due to overvoltage limit operation, the output frequency exceeded &lt;FH: Maximum frequency&gt; +12 Hz or &lt;FH&gt; + &lt;vL: Base frequency 1&gt; x 0.1.</p>	<p>1) 3)</p> <ul style="list-style-type: none"> <li>Check whether a problem exists in input voltage.</li> <li>When the regenerative energy is large, install a braking resistor (option).</li> </ul> <p>2) Check the PG wiring and setting.</p>
E-18	0032	Analog input disconnecting *	The input level of the terminal [II] became the setting value or less of <F633: II analog input disconnection detection level>	<ul style="list-style-type: none"> <li>Check that the signal line connected to the terminal [II] is not disconnected.</li> <li>Check if the &lt;F633&gt; setting is correct.</li> </ul>
E-19	0033	CPU communication error	Communication error between control CPU.	Turn off the power and then turn it on again. If the error occurs again, contact your Toshiba distributor.
E-20	0034	Over torque boost	<ul style="list-style-type: none"> <li>The setting value of the &lt;F402: Automatic torque boost&gt; is very high.</li> <li>Impedance on the motor is low.</li> </ul>	Set the motor parameters according to the motor characteristic, and perform auto-tuning. <vL: Base frequency 1>, <vLv: Base frequency voltage>, <F405: Motor rated capacity>, <F415: Motor rated current>, <F417: Motor rated speed>, <F400: Offline auto-tuning>, etc.
E-21	0035	CPU1 fault B	Control CPU fault.	Fault in internal inverter. Contact your Toshiba distributor.
E-22	0036	Embedded Ethernet fault	Fault in the embedded Ethernet.	Fault in internal inverter. Contact your Toshiba distributor.
E-23	0037	Option fault (slot A)	Fault in the option connected to slot A.	Fault in the option. Contact your Toshiba distributor.
E-24	0038	Option fault (slot B)	Fault in the option connected to slot B.	Fault in the option. Contact your Toshiba distributor.
E-25	0039	Option fault (slot C)	Fault in option 3.	Fault in the option. Contact your Toshiba distributor.
E-26	003A	CPU2 fault	Control CPU fault.	Fault in internal inverter. Contact your Toshiba distributor.

\*Enable/Disable can be selected for trip with a parameter.



Trip display	Failure code	Trip name	Detection factor	Measures
E-29	003D	Control power option failure *	1) Failure on the control power supply option. 2) The setting of <F647: Control power option failure detection> is improper.	1) When input voltage of the control power supply is normal and the voltage between terminals [+SU]-[CC] is under 20 Vdc, it is a failure in the control power supply option. Contact your Toshiba distributor. 2) When the control power supply option is not used, set <F647> = "0".
E-31	003F	Rush current suppression relay fault	1) Fault on the rush current suppression relay. 2) The power was turned ON/OFF frequently.	1) Fault in internal inverter. Contact your Toshiba distributor. 2) Instead of turning ON/OFF with the power supply, turn ON/OFF with a run command.
E-32	0040	PTC failure	1) PTC protection for the motor became enabled. 2) Failure in the PTC circuit.	1) Check the motor and PTC. 2) Failure in internal inverter. Contact your Toshiba distributor.
E-37	0045	Servo lock error	1) The lock up torque or more external load is applied to the motor. 2) Setting of motor parameters is improper.	1) Reduce the load to apply the servo lock. 2) Set the motor parameters according to the motor characteristic, and perform auto-tuning. <vL: Base frequency 1>, <vLv: Base frequency voltage>, <F405: Motor rated capacity>, <F415: Motor rated current>, <F417: Motor rated speed>, <F400: Offline auto-tuning>, etc.
E-38	0046	Communication time-out of A6 Brake Unit	1) The wire linked VF-AS3 to A6 Brake Unit is disconnected. 2) The A6 Brake Unit is failed.	1) Check the wire linked VF-AS3 to A6 Brake Unit. 2) Turn off the power and then turn it on again. If the fault occurs again, contact your Toshiba distributor.
E-39	0047	PM control error	During auto-tuning or initial position, the motor current became very high.	Measure inductance with a LCR meter, etc., and set to the parameter directly.
E-42	004A	Cooling fan fault	The cooling fan failed.	The cooling fan needs to be replaced. Contact your Toshiba distributor.
E-43	004B	Communication time-out (embedded Ethernet)	Embedded Ethernet communication timed out.	Check the Ethernet communication equipment and wiring.
E-44	004C	Battery of panel failure	Calendar function is activated, and under one of these cases. 1) A battery is not in. 2) The battery level is low.	1) Put a battery. 2) Replace the battery.
E-45	004D	GD2 auto-tuning error	• The value of F459 is not fixed. • Estimated value of F459 is out of parameter range.	1) Modify the value of F481, F482 and do the tuning again. 2) Modify F480 to 0, and set the appropriate value of F459 manually.
E-48	0050	A6 Brake Unit internal fault	An internal error occurred in A6 Brake Unit.	Turn off the power and then turn it on again. If the fault occurs again, contact your Toshiba distributor.
E-99	0058	Trip for test *	Trip for test occurred.	Reset if no problem is found.

\*Enable/Disable can be selected for trip with a parameter.

Trip display	Failure code	Trip name	Detection factor	Measures
EEP1	0012	EEPROM fault 1	Fault occurred during internal data writing.	Turn off the power and then turn it on again. If the fault occurs again, contact your Toshiba distributor.
EEP2	0013	EEPROM fault 2	1) While setting <tyP: Default setting>, the power was turned OFF or momentary power failure occurred. 2) Fault occurred during internal data writing.	1) Set <tyP> again. If the fault occurs again, contact your Toshiba distributor. 2) Turn off the power and then turn it on again. If the fault occurs again, contact your Toshiba distributor.
EEP3	0014	EEPROM fault 3	Fault occurred during internal data reading.	Turn off the power and then turn it on again. If the fault occurs again, contact your Toshiba distributor.
EF2	0022	Grounding fault *	1) Grounding fault occurred in the output wiring or the motor. 2) Fault can occur depends on motor, in case of rapid acceleration/deceleration.	1) Check grounding fault in the wiring on the output side and the motor. 2) Increase the acceleration/deceleration time. <ACC/dEC acceleration/ deceleration time 1>
EPHI	0008	Input phase loss *	1) Input side phase has failed.	1) Check phase failure in the wiring on the input side.
EPHO	0009	Output phase loss *	1) Output side phase has failed. 2) Output current is quite small (less than 8%) to motor rated current.	1) Check phase failure in the wiring on the output side. 2) Set <F605> to 0
Err2	0015	RAM fault	Control RAM fault.	Fault in internal inverter. Contact your Toshiba distributor.
Err3	0016	ROM fault	Control ROM fault.	Fault in internal inverter. Contact your Toshiba distributor.
Err4	0017	CPU1 fault A	Control CPU fault.	Fault in internal inverter. Contact your Toshiba distributor.
Err5	0018	Communication time-out (RS485)	RS485 communication timed out.	Check the communication equipment and wiring on RS485 communication.
Err6	0019	Gate array fault	Fault in the gate array.	Fault in internal inverter. Contact your Toshiba distributor.
Err7	001A	Current detector fault	Fault in the output current detector.	Fault in internal inverter. Contact your Toshiba distributor.
Err8	001B	Communication time-out (option)	Communication option timed out.	Check the communication equipment and wiring on communication option.
Err9	001C	Panel disconnection during run	While running with a run command from the operation panel and extension panel, the cable connecting the inverter and panel are disconnected.	Check the connection on the inverter and panel.

\*Enable/Disable can be selected for trip with a parameter.

Trip display	Failure code	Trip name	Detection factor	Measures
Etn	0028	Auto-tuning error	<ol style="list-style-type: none"> <li>1) The motor parameter does not match the motor characteristic.</li> <li>2) Executed auto-tuning while the motor is rotating.</li> <li>3) The output frequency does not increase within few minutes.</li> </ol>	<ol style="list-style-type: none"> <li>1) Set the motor parameters according to the motor characteristic. &lt;vL: Base frequency 1&gt;, &lt;vLv: Base frequency voltage&gt;, &lt;F405: Motor rated capacity&gt;, &lt;F415: Motor rated current&gt;, &lt;F417: Motor rated speed&gt;, etc.</li> <li>2) Check that the motor is stopped, and perform auto-tuning again.</li> <li>3) Check that the motor is not stopped while the output frequency is rising on the system.</li> </ol>
Etn1	0054	Auto-tuning error 1	<ol style="list-style-type: none"> <li>1) The motor is not connected.</li> <li>2) Something other than the motor is connected.</li> <li>3) In the induction motor, an improper value, a synchronized motor speed value or a value close to it is set in &lt;F417: Motor rated speed&gt;.</li> </ol>	<ol style="list-style-type: none"> <li>1) and 2) Check that the motor is connected.</li> <li>3) Set &lt;F417&gt; according to the motor rating.</li> </ol>
Etn2	0055	Auto-tuning error 2	The motor parameter does not match the motor characteristic.	Set the motor parameters according to the motor characteristic. <vL: Base frequency 1>, <vLv: Base frequency voltage>, <F405: Motor rated capacity>, <F415: Motor rated current>, <F417: Motor rated speed>, etc.
Etn3	0056	Auto-tuning error 3	The setting on <vL: Base frequency 1> or <F417: Motor rated speed> does not match the motor rating.	Set <vL: Base frequency 1> or <F417: Motor rated speed> according to the motor rating.
EtyP	0029	Inverter type error	<ol style="list-style-type: none"> <li>1) Internal error exists.</li> <li>2) Replaced the printed circuit board (contact your Toshiba distributor for replacing the printed circuit board).</li> </ol>	<ol style="list-style-type: none"> <li>1) Error in internal inverter. Contact your Toshiba distributor.</li> <li>2) Set &lt;tyP: Default setting&gt; = "6: Initialize typeform".</li> </ol>
OC1	0001	Overcurrent (during acceleration)	<ol style="list-style-type: none"> <li>1) The acceleration time is short.</li> <li>2) &lt;Pt: V/f Pattern&gt; does not match the machinery.</li> <li>3) Momentary power failure occurred, and tried to start the rotating motor.</li> <li>4) Tried to run the special motor (impedance small).</li> <li>5) Tried to run a low inductance motor like a high-speed motor.</li> <li>6) When &lt;Pt&gt; = "11", polarity of PG is opposite.</li> <li>7) When &lt;F614: Pulse width of short circuit detection at start&gt; = "0", and &lt;F613&gt;=2, or 3, inverter output short circuit.</li> </ol>	<ol style="list-style-type: none"> <li>1) Increase the acceleration time. &lt;ACC: Acceleration time 1&gt;, etc.</li> <li>2) Set &lt;Pt: V/f Pattern&gt; according to the machinery.</li> <li>3) Set &lt;F301: Auto-restart&gt;. Depending on the characteristic of machinery, &lt;F302: Regenerative power ride-through&gt; = "1" is also effective.</li> <li>4) When &lt;Pt&gt; is set to "0", "1", "2", or "7", lower &lt;vb: Manual torque boost 1&gt;. For settings other than "0", "1", "2", or "7", perform auto-tuning with &lt;F400: Offline auto-tuning&gt;. &lt;F402: Automatic torque boost&gt; is set matching the motor.</li> <li>5) Change the inverter to large capacity.</li> </ol>
OC2	0002	Overcurrent (during deceleration)	<ol style="list-style-type: none"> <li>1) The deceleration time is short.</li> <li>2) Tried to run a low inductance motor like a high-speed motor.</li> <li>3) When &lt;Pt&gt; = "11", polarity of PG is opposite.</li> <li>4) When &lt;F614: Pulse width of short circuit detection at start&gt; = "0", and &lt;F613&gt;=2, or 3 inverter output short circuit.</li> </ol>	<ol style="list-style-type: none"> <li>1) Increase the deceleration time. &lt;dEC: Deceleration time 1&gt;, etc.</li> <li>2) Change the inverter to large capacity.</li> </ol>

\*Enable/Disable can be selected for trip with a parameter.

Trip display	Failure code	Trip name	Detection factor	Measures
OC3	0003	Overcurrent (during constant speed running)	<ol style="list-style-type: none"> <li>1) The load changed rapidly.</li> <li>2) Error occurred in the machinery (something got stuck, etc.).</li> <li>3) Tried to run a low inductance motor like a high-speed motor.</li> <li>4) When &lt;Pt&gt; = "11", polarity of PG is opposite.</li> <li>5) When &lt;F614: Pulse width of short circuit detection at start&gt; = "0", and &lt;F613&gt;=2, or 3 inverter output short circuit.</li> </ol>	<ol style="list-style-type: none"> <li>1) Suppress load fluctuation.</li> <li>2) Check whether a problem exists in the machinery.</li> <li>3) Change the inverter to large capacity.</li> </ol>
OCA1	0005	Overcurrent (U-phase arm)	Fault on IGBT in U-phase.	Fault in internal inverter. Contact your Toshiba distributor.
OCA2	0006	Overcurrent (V-phase arm)	Fault on IGBT in V-phase.	Fault in internal inverter. Contact your Toshiba distributor.
OCA3	0007	Overcurrent (W-phase arm)	Fault on IGBT in W-phase.	Fault in internal inverter. Contact your Toshiba distributor.
OCL	0004	Overcurrent (load side at startup)	<ol style="list-style-type: none"> <li>1) Short circuit occurred on the output side.</li> <li>2) The motor and output side wiring have defective insulation.</li> <li>3) Impedance on the motor is low.</li> </ol>	<ol style="list-style-type: none"> <li>1) Check the wiring on the output side.</li> <li>2) Check the insulation on the output side.</li> <li>3) Set &lt;F613: Short circuit detection at start&gt; to "2" or "3".</li> </ol>
OCr	0024	Overcurrent (Braking resistor)	<ol style="list-style-type: none"> <li>1) When "Enabled" is set in &lt;F304: Dynamic braking, OLR trip&gt;: <ul style="list-style-type: none"> <li>• The braking resistor is not connected.</li> <li>• The braking resistor connection is disconnected.</li> <li>• A braking resistor with a resistance value under the minimum allowable resistance value is connected.</li> </ul> </li> <li>2) Short circuit occurred between [PB] and [PC/-].</li> <li>3) IGBT fault on the dynamic braking drive circuit control.</li> </ol>	<ol style="list-style-type: none"> <li>1) Check if an adequate braking resistor is connected. When a braking resistor is not necessary, set "Disabled" in &lt;F304&gt;.</li> <li>2) Check for problems on impedance of the braking resistor, wiring, etc.</li> <li>3) Fault in internal inverter. Contact your Toshiba distributor.</li> </ol> <p>* This trip can not be reset. For trip clear, turn off the power and then turn it on again.</p>
OH	0010	Overheat	<ol style="list-style-type: none"> <li>1) The cooling fan is not working.</li> <li>2) Ambient temperature is high.</li> <li>3) The vent of the cooling fan is blocked.</li> <li>4) Other heating units are nearby.</li> </ol>	<ol style="list-style-type: none"> <li>1) Replace if the cooling fan is not working during run.</li> <li>2) Lower the ambient temperature. Reset after the inverter cools down.</li> <li>3) Make sure the vent of the cooling fan is not blocked.</li> <li>4) Place other heating units away from the inverter.</li> </ol>
OH2	002E	External thermal trip *	A signal of external thermal trip is input.	Check that the motor is not overloaded.
OL1	000D	Overload (Inverter)	<ol style="list-style-type: none"> <li>1) Sudden acceleration occurs and the acceleration time is short.</li> <li>2) &lt;Pt: V/f Pattern&gt; does not match the machinery.</li> <li>3) Momentary power failure occurred, and tried to start the rotating motor.</li> <li>4) The DC braking amount is large.</li> <li>5) The load is large for the inverter capacity.</li> </ol>	<ol style="list-style-type: none"> <li>1) Increase the acceleration time. &lt;ACC: Acceleration time 1&gt;, etc.</li> <li>2) Set &lt;Pt: V/f Pattern&gt; according to the machinery.</li> <li>3) Set &lt;F301: Auto-restart&gt;. Depending on the characteristic of machinery, &lt;F302: Regenerative power ride-through&gt; = "1" is also effective.</li> <li>4) Set &lt;F251: DC braking current&gt; small and &lt;F252: DC braking time&gt; short.</li> <li>5) Change the inverter to large capacity.</li> </ol>

\*Enable/Disable can be selected for trip with a parameter.

Trip display	Failure code	Trip name	Detection factor	Measures
OL2	000E	Overload (Motor) *	<ol style="list-style-type: none"> <li>1) The motor is locked up.</li> <li>2) Operation continues in low-speed range.</li> <li>3) The motor is overloaded.</li> <li>4) The setting of the electronic thermal does not match the motor characteristic.</li> <li>5) &lt;Pt: V/f Pattern&gt; does not match the machinery.</li> </ol>	<ol style="list-style-type: none"> <li>1) Check the machinery.</li> <li>2), 3), and 4) Set the electronic thermal according to the motor. &lt;OLM: Motor overload protection characteristic&gt;, &lt;tHrA: Motor overload protection current 1&gt;, etc.</li> <li>5) Set &lt;Pt: V/f Pattern&gt; according to the machinery.</li> </ol>
OL3	003E	Overload (IGBT)	<ol style="list-style-type: none"> <li>1) While operating the low-speed range (15 Hz or less) with high carrier frequency, overload occurred.</li> <li>2) Momentary power failure occurred, and tried to start the rotating motor.</li> </ol>	<ol style="list-style-type: none"> <li>1) <ul style="list-style-type: none"> <li>• Reduce the load.</li> <li>• Lower the carrier frequency. Or set &lt;F316: Carrier frequency control&gt; to "Valid decrease".</li> <li>• Increase the output frequency.</li> </ul> </li> <li>2) Set &lt;F301: Auto-restart&gt;. Depending on the characteristic of machinery, &lt;F302: Regenerative power ride-through&gt; = "1" is also effective.</li> </ol>
OLr	000F	Overload (Braking resistor) *	<ol style="list-style-type: none"> <li>1) The braking rate is large.</li> <li>2) The deceleration time is short.</li> </ol>	<ul style="list-style-type: none"> <li>• Increase the deceleration time. &lt;dEC: Deceleration time 1&gt;, etc.</li> <li>• Change the braking resistor (option) to a large capacity, and set &lt;F309: Braking resistor capacity&gt;.</li> </ul>
OP1	000A	Overvoltage (during acceleration)	<ol style="list-style-type: none"> <li>1) Input voltage is high and showed abnormal fluctuation.</li> <li>2) Connection is made as the following system. <ul style="list-style-type: none"> <li>• Power supply capacity is 500 kVA or more.</li> <li>• The power factor improvement capacitor was opened/closed.</li> <li>• Equipment is connected that uses thyristor on the same system.</li> </ul> </li> <li>3) Momentary power failure occurred, and tried to start the rotating motor.</li> </ol>	<ol style="list-style-type: none"> <li>1) Use within the power supply voltage range. When no problem is found in the input voltage, install an input AC reactor (option).</li> <li>2) Install an input AC reactor (option).</li> <li>3) Set &lt;F301: Auto-restart&gt;. Depending on the characteristic of machinery, &lt;F302: Regenerative power ride-through&gt; = "1" is also effective.</li> </ol>
OP2	000B	Overvoltage (during deceleration)	<ol style="list-style-type: none"> <li>1) The deceleration time is short and the regenerative energy is large.</li> <li>2) &lt;F305: Overvoltage limit operation&gt; is set to "1: Disabled".</li> <li>3) Input voltage is high and showed abnormal fluctuation.</li> <li>4) Connection is made as the following system. <ul style="list-style-type: none"> <li>• Power supply capacity is 500 kVA or more.</li> <li>• The power factor improvement capacitor was opened/closed.</li> <li>• Equipment is connected that uses thyristor on the same system.</li> </ul> </li> </ol>	<ol style="list-style-type: none"> <li>1) <ul style="list-style-type: none"> <li>• Increase the deceleration time. &lt;dEC: Deceleration time 1&gt;, etc.</li> <li>• When the regenerative energy is large, install a braking resistor.</li> </ul> </li> <li>2) Change &lt;F305&gt; = "0", "2", and "3" to enable the Overvoltage limit operation. When the deceleration time is limited, install a braking resistor (option).</li> <li>3) Use within the power supply voltage range. When no problem is found in the input voltage, install an input AC reactor (option).</li> <li>4) Install an input AC reactor (option).</li> </ol>

\*Enable/Disable can be selected for trip with a parameter.

Trip display	Failure code	Trip name	Detection factor	Measures
OP3	000C	Overvoltage (during constant speed running)	1) Input voltage is high and showed abnormal fluctuation. 2) Connection is made as the following system. <ul style="list-style-type: none"> <li>• Power supply capacity is 500 kVA or more.</li> <li>• The power factor improvement capacitor was opened/closed.</li> <li>• Equipment is connected that uses thyristor on the same system.</li> </ul> 3) The motor was rotated with the force on the load side, and it became to regenerative status.	1) Use within the power supply voltage range. When no problem is found in the input voltage, install an input AC reactor (option). 2) Install an input AC reactor (option). 3) Install a braking resistor (option).
Ot	0020	Overtorque *	The load torque reached the overtorque level during run.	<ul style="list-style-type: none"> <li>• Check the load side.</li> <li>• Check the overtorque detection setting is correct.</li> </ul> <F615: Overtorque trip>, <F616: Overtorque detection level during power running>, <F617: Overtorque detection level during regen>, <F618: Overtorque detection time>, etc.
Ot2	0041	Overtorque 2	1) The output current during power running reached <F601: Stall prevention level 1> or more, and the setting time in <F452: Stall detection time during power running> elapsed. 2) The power running torque during power running reached <F441: Power running torque limit level 1> or more, and the setting time in <F452: Stall detection time during power running> elapsed.	<ul style="list-style-type: none"> <li>• Reduce the load.</li> <li>• Lower the detection level of &lt;F601&gt; or &lt;F441&gt;.</li> </ul>
OtC3	0048	Overtorque/ Overcurrent *	Overtorque or overcurrent on the shock monitoring function was detected.	<ul style="list-style-type: none"> <li>• Check the load.</li> <li>• When no problem is found, check if the shock monitoring function setting is correct.</li> </ul> <F590: Shock monitoring> to <F598: Shock monitoring detection condition>
PrF	003B	STO circuit fault	Fault in the safe torque off (STO) circuit.	Fault inside the inverter. Contact your Toshiba distributor.
SOUT	002F	PM step-out *	1) The load changed rapidly. 2) Sudden acceleration/deceleration occurs. 3) The motor shaft is locked up. 4) Output side phase has failed.	1) and 2) Increase the acceleration/ deceleration time. <ACC: Acceleration time1>, <dEC: Deceleration time 1>, etc. 3) Check the motor and release the lock. 4) Check the wiring on the output side.
UC	001D	Undercurrent *	The output current declined to the undercurrent detection level during run.	<ul style="list-style-type: none"> <li>• Check the load.</li> <li>• Check that the undercurrent detection setting is correct.</li> </ul> <F610: Undercurrent trip>, <F611: Undercurrent detection level>, <F612: Undercurrent detection time>, etc.

\*Enable/Disable can be selected for trip with a parameter.

Trip display	Failure code	Trip name	Detection factor	Measures
UP1	001E	Undervoltage (Power circuit) *	The input voltage (power circuit) declined.	<ul style="list-style-type: none"> <li>Check the input voltage.</li> <li>Check that the undervoltage detection setting is correct. &lt;F625: Undervoltage detection level&gt;, &lt;F627: Undervoltage trip&gt;, etc.</li> <li>To avoid trip in momentary power failure, set &lt;F627&gt; = "0: Disabled", and set &lt;F301: Auto-restart&gt; and &lt;F302: Regenerative power ride-through level&gt; to "1".</li> </ul>
Ut	003C	Undertorque *	The load torque reached the undertorque level during run.	<ul style="list-style-type: none"> <li>Check the load side.</li> <li>Check that the undertorque detection setting is correct. &lt;F651: Undertorque trip&gt;, &lt;F652: Undertorque detection level during power running&gt;, &lt;F653: Undertorque detection level during regen&gt;, &lt;F654: Undertorque detection time&gt;, etc.</li> </ul>
UtC3	0049	Undertorque/ Undercurrent *	Undertorque or undercurrent on the shock monitoring function was detected.	<ul style="list-style-type: none"> <li>Check the load.</li> <li>When no problem is found, check if the shock monitoring function setting is correct. &lt;F590: Shock monitoring&gt; to &lt;F598: Shock monitoring detection condition&gt;</li> </ul>

\*Enable/Disable can be selected for trip with a parameter.

■ Alarm information

Alarm display	English	Detection factor	Measures
A-09	Panel disconnection alarm	The cable connecting the inverter and panel are disconnected during run with a run command from the operation panel and extension panel.	Check the connection on the inverter and panel.
A-17	Key failure alarm	<ul style="list-style-type: none"> <li>[RUN] or [STOP/RESET] key on the operation panel is pressed and hold for 20 seconds or more.</li> <li>The operation panel key has failed.</li> </ul>	Check the operation panel. If the failure occurs again, contact your Toshiba distributor.
A-18	Analog input disconnection alarm	The input level of the terminal [II] became the setting value or less of <F633: II analog input disconnection detection level> .	<ul style="list-style-type: none"> <li>Check that the signal line connected to the terminal [II] is not disconnected.</li> <li>Check that the &lt;F633&gt; setting is correct.</li> </ul>
A-43	Communication alarm (embedded Ethernet)	Condition very close to the communication time out trip.	Perform the same measures with communication time out "E-43".
COFF	Control power option alarm	<ol style="list-style-type: none"> <li>Undervoltage on the control power supply input between [+SU] and [CC].</li> <li>The setting of &lt;F647: Control power option failure detection&gt; is improper.</li> </ol>	<ol style="list-style-type: none"> <li>Check the voltage on the control power supply input between [+SU] and [CC]. 20 Vdc or more is required.</li> <li>When the control power supply option is not used, set &lt;F647&gt; = "0".</li> </ol> <p>*When [COFF] occurs, turn the power OFF once, and reset.</p>
MOFF	Undervoltage alarm	The input voltage (power circuit) declined.	Check the input voltage. If no problem is found, internal error may be the issue. Contact your Toshiba distributor.

Alarm display	English	Detection factor	Measures
PrA	STO activated	1) Open state between [STOA]/[STOB] and [PLC] terminal. 2) 24V output terminal [PLC]/[P24] overload. 3) SW1 is set on "PLC" position and an external power is not supplied.	1) Short circuit [STOA] - [STOB] - [PLC]. (By default, short circuit is done with a shorting bar). 2) Check 24V load. 3) Check SW1 position and external power supply.
t	Communication alarm (RS485, option)	Condition very close to the communication time out trip.	Perform the same measures with communication time out "Err5" and "Err8".
tUn1	Brake learning error	1) The load is heavy. 2) Parameter setting is improper. 3) Braking operation is abnormal.	1) Perform learning with no load or light load in approx. 3 % or less rating. 2) Set the motor parameters and learning related parameters in advance. 3) Check the brake.
tUn3	Light-load high-speed learning error	Setting of the motor parameter is improper.	Set the motor parameters according to the motor.

■ **Pre-alarm information**

Pre-alarm display	English	Detection factor	Measures
C	Overcurrent pre-alarm	Condition close to the overcurrent trip.	Perform the same measures with overcurrent "OC1", "OC2", and "OC3".
H	Overheat pre-alarm	Condition close to the overheat trip.	Perform the same measures with overheat "OH".
L	Motor overload pre-alarm	Condition close to the overload trip.	Perform the same measures with overload "OL1", "OL2", and "OL3".
P	Overvoltage pre-alarm	Condition close to the overvoltage trip.	Perform the same measures with overvoltage "OP1", "OP2", and "OP3".

■ **Message information**

Message display	English	Description	Remarks
A-01	V/f 5-point setting error 1	When <Pt:V/f Pattern> = "7: V/f 5-point setting", two or more from <vL>, <F190>, <F192>, <F194>, <F196> and <F198> are set to the same value other than 0.0 Hz.	Set different value on each parameter.
A-02	V/f 5-point setting error 2	Inclination of V/f is large.	<ul style="list-style-type: none"> <li>Set V/f 5-point and &lt;vLv&gt;/&lt;vL&gt; for the V/f inclination to be gentle.</li> <li>Increase the value of &lt;vL&gt;, or decrease the value of &lt;vLv&gt;.</li> </ul>
A-05	Base frequency setting error	Tries to run in frequency over 10 times of the base frequency.	<ul style="list-style-type: none"> <li>Check that the base frequency setting is correct. &lt;vL: Base frequency 1&gt;, etc.</li> <li>Operate in frequency within 10 times of the base frequency.</li> </ul>
ASIA	Setting for Asia	Setting for Asia is selected in the setup menu.	-
Atn	During auto tuning	Auto-tuning in progress.	A message that indicates auto-tuning in progress. No problem if the message disappears after several seconds.



Message display	English	Description	Remarks
CHn	Setting for China	Setting for China is selected in the setup menu.	-
CLr	Reset command acceptable	The following was operated after trip is occurring. 1) Pressed [STOP] key once. 2) Set the reset terminal ON. (During trip resetting operation)	Reset is performed with the following operation. 1) Press [STOP] key again. 2) Set the reset terminal OFF.
db	During DC braking	DC braking in progress.	-
dbOn	During motor shaft fixing	Motor shaft fixing in progress.	A message indicates the motor fixing control in progress. When standby is turned OFF, the control stops.
E1	Panel display one digit overflow	The display digit on the operation panel overflowed by one digit.	-
E2	Panel display two digits overflow	The display digit on the operation panel overflowed by two digits.	-
E3	Panel display three digits overflow	The display digit on the operation panel overflowed by three digits.	-
EASy	Easy mode	Switched to [Easy mode].	-
End	Last of data	The last data item in <History function>.	-
EOFF	Emergency off command acceptable	When a run command is other than the operation panel, [STOP/RESET] key was pressed once.	To apply emergency off, press [STOP] key again. If emergency off does not occur, press other keys.
Err1	Frequency point setting error	The setting on point 1 and point 2 of the frequency command is close.	Set apart point 1 and point 2 of the frequency command.
EU	Setting for Europe	Setting for Europe is selected in the setup menu.	-
FAIL	Password failure	Entered number in <F739: Password verification> does not match <F738: Password setting>.	-
FlrE	During Fire speed run/Forced run	Fire speed run/Forced run is in progress. ("FlrE" and the output frequency are alternately displayed)	A message indicates fire speed run/forced run in progress. It stops when turning the power OFF.
FJOG	Fwd JOG	Forward jog run in progress.	-
HEAd	Head of data	The first data item in <History function>.	-
HI	Upper limit of setting value	The upper limit of the setting value.	-
Init	During Initializing	<ul style="list-style-type: none"> <li>Set &lt;tyP: Default setting&gt; = "3" or "13" and initialization is in progress.</li> <li>Region setting in progress with the setup menu.</li> </ul>	No problem if the display shows "0.0" after several seconds.
JP	Setting for Japan	Setting for Japan is selected in the setup menu.	-
LO	Lower limit of setting value	The lower limit of the setting value.	-
LStP	During run sleep	Run sleep in progress.	-
n---	No detailed information of past trip	While "nErr" and a value are alternately displayed, [OK] key is pressed and detailed information are read.	Normal display.

Message display	English	Description	Remarks
nErr	No error	No trip records in the past trip history on [Monitor mode].	-
OFF	Standby OFF	The input terminal with assigned standby is OFF.	-
PASS	Password coincidence	Entered number in <F739: Password verification> matched <F738: Password setting>.	-
rJOG	Rev JOG	Reverse jog run in progress.	-
rtry	During Retry/Speed search	Retry/speed search in progress.	-
SEt	Region setting acceptable	<ul style="list-style-type: none"> <li>• Display at first power on.</li> <li>• Display after setting &lt;SEt&gt; = "0".</li> </ul>	Set a region to use in the setup menu.
Srvo	During servo lock	Servo lock in progress.	-
Std	Setting mode	Switched to [Setting mode].	-
StOP	During deceleration stop at power failure	Deceleration stop at power failure in progress.	A message indicates deceleration stop during power failure. The stop state is kept until the run command is turned OFF.
tUn	During learning	Learning the brake sequence or light-load high-speed operation in progress. ("tUn1" and the output frequency are alternately displayed)	-
tUn2	Light-load high-speed learning setting error	Error exists in learning operation.	Refer to Operation Manual, and perform learning operation.
U---	Waiting for search	Waiting for search condition in <Changed parameters search & edit>.	-
U--F	During forward search	Forward search in progress in <Changed parameters search & edit>.	-
Undo	All key unlocked	When "Locked" is set in <F737: Panel keys lockout>, pressed [OK] key for five seconds or more.	The key operation on the operation panel is temporarily valid.
U--r	During reverse search	Reverse search in progress in <Changed parameters search & edit>.	-
USA	Setting for North America	Setting for North America is selected in the setup menu.	-

## 13. 2 How to reset trip



Important

- Reset the inverter that has tripped after eliminating the cause of the trip. If it is not eliminated, the inverter will trip again even after reset. Pay enough attention.

The inverter can be reset with the following four methods after a trip occurs.

### (1) Panel operation

You can reset from the operation panel even if terminal run or communication run is performed when the trip occurs.

The following is the reset procedure.

- 1 Press the [STOP/RESET] key with the trip displayed.  
"CLr" blinks in the main area, and "Trip reset? (STOP-Key)" is displayed on the lower side.
  - The backlight is red.  
(It is white when the setting of the backlight is changed.)



- 2 When you press the [STOP/RESET] key again while "CLr" is blinking, the trip is reset. The display on the screen once disappears, and the screen immediately after power on is displayed. The backlight returns to white.

### (2) Terminal input (external signal)

Short the terminal [RES] and then open.

The inverter is reset when the terminal is opened.

In the default setting, the function "8: Reset 1" is assigned to the terminal [RES].

To reset with other input terminal, assignment of the reset function is required.

### (3) Communication

For details, refer to "RS485 Communication Function Instruction Manual" (E6582143).

### (4) Turning off power

Turn OFF the power and then turn it ON again.

When the power is off, some contents of the monitor at the time of the trip are lost.

To retain the contents of the monitor at the time of the trip, set <F602: Trip record retention> to "1: Retain at power off." Even after the inverter is reset with power off, the stored contents of the trip are displayed.

For details, refer to [6. 30. 3].



Important

- The inverter can be reset with power off, however, note that the equipment and the motor are damaged if the power is turned off frequently.

■ **When the inverter cannot be reset immediately after the trip**

- 1) **For overload (inverter) "OL1", overload (motor) "OL2" and overload (braking resistor) "OLr", virtual cooling time is provided. During this time, the inverter cannot be reset by external signal or from the operation panel.**

The reference virtual cooling time is as follows.

- "OL1": approximately 30 seconds after the occurrence of a trip
- "OL2": approximately 120 seconds after the occurrence of a trip
- "OLr": approximately 20 seconds after the occurrence of a trip

For overload (IGBT) "OL3", there is no virtual cooling time.

- 2) **In case of overheat "OH", the inverter checks the temperature within. Wait until the temperature in the inverter falls sufficiently before resetting the inverter.**
- 3) **In case of overvoltage "OP1", "OP2" and "OP3", wait until the power circuit voltage decrease under the setting value of <F626: Overvoltage limit operation level>.**
- 4) **The inverter cannot be reset while the emergency off signal is being input to the input terminal.**
- 5) **The inverter cannot be reset while a pre-alarm occurs.**

## 13.3 If motor does not run while no trip message is displayed

If the motor does not run while no trip message is displayed, follow these steps to track down the cause.

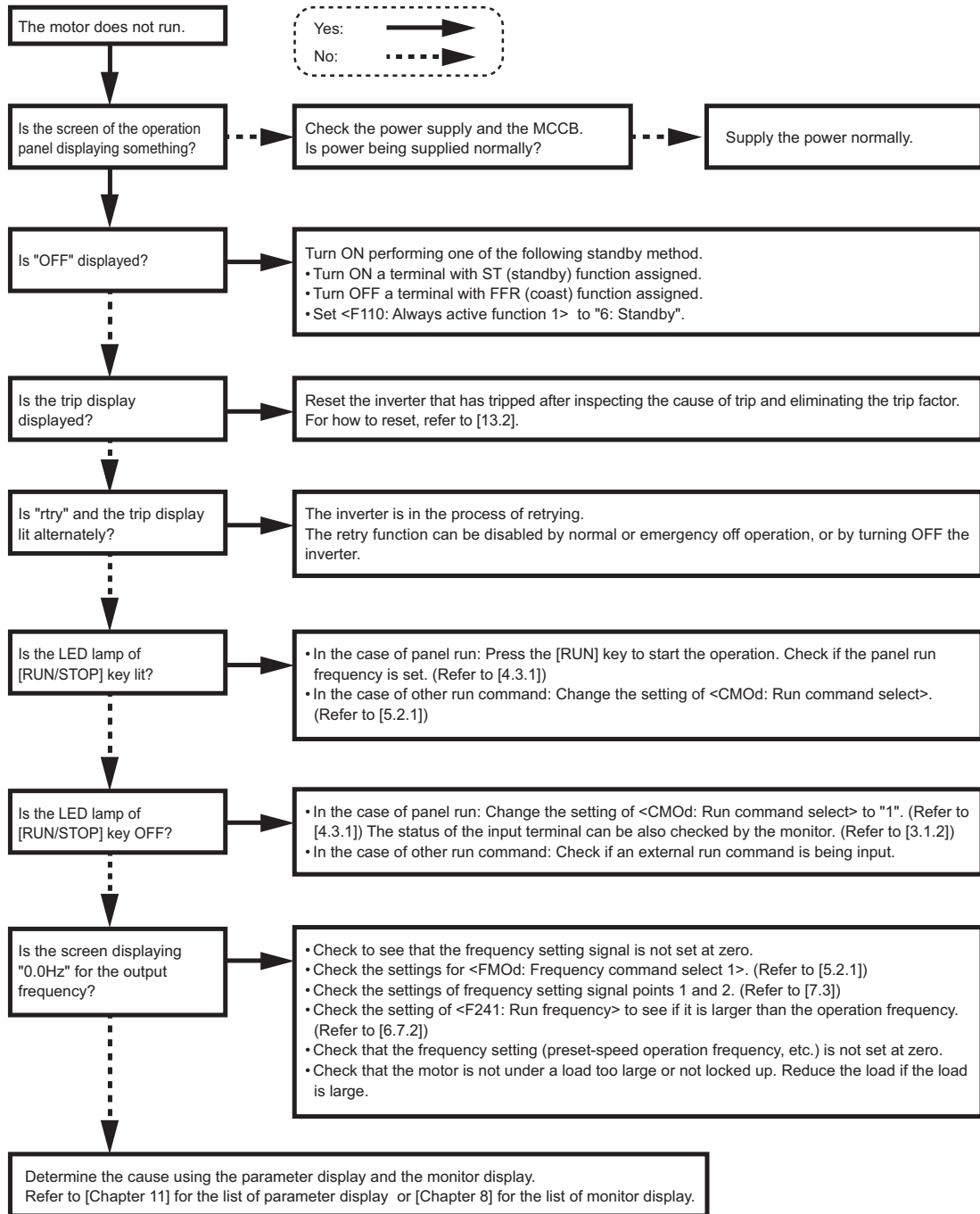

## 13. 4 How to determine causes of other problems

The following table provides a listing of other problems, their possible causes and measures.

Problems	Causes	Measures
The motor runs in the wrong direction.	- The phase sequence of the output terminals [U/T1], [V/T2] and [W/T3] is wrong.	- Invert the phases of the output terminals [U/T1], [V/T2] and [W/T3].
	- The Fwd/Rev run signals are input inversely in terminal run.	- Invert the Fwd/Rev run signal terminals of the external input device. (Refer to [7. 2])
	- The setting of <Fr: Panel Fwd/Rev run select> is incorrect in panel run.	- Change <Fr> setting.
The motor runs but its frequency does not change.	- The load is large.	- Reduce the load.
	- The overload stall function is activated.	- Disable the overload stall function OFF in <OLM: Motor overload protection characteristic>, and reduce the load (Refer to [5. 2. 5]).
	- <FH: Maximum frequency> and <UL: Upper limit frequency> are set too low.	- Increase the setting values of these parameters.
	- The value of analog signal in the frequency command is small.	- Check the value of the signal, circuit, wiring, etc. - Check the characteristics (point 1 and point 2 setting) of the analog signal. (Refer to [7. 3])
	- If the motor runs at a low speed, the torque boost value is too large.	- Check if an overcurrent alarm or overload alarm has occurred and adjust <vb: Manual torque boost 1> and <ACC: Acceleration time 1>. (Refer to [5. 3. 6] and [5. 2. 4])
The motor does not accelerate or decelerate smoothly.	- <ACC: Acceleration time 1> or <dEC: Deceleration time 1> is set too short.	- Increase the value of each parameter.
A too large current flows into the motor.	- The load is large.	- Reduce the load.
	- If the motor runs at a low speed, the torque boost value is too large.	- Check if the value of <vb: Manual torque boost 1> is too large. (Refer to [5. 3. 6])
The motor runs at a higher or lower speed than the specified one.	- The motor has an improper voltage rating.	- Use a motor with a proper voltage rating.
	- The motor terminal voltage is too low.	- Check the setting value of <vLv: Base frequency voltage 1>. (Refer to [5. 2. 2]) - Change the wire size to large.
	- The reduction gear ratio, etc., are not set properly.	- Adjust the reduction gear ratio, etc.
	- The frequency command is not set correctly.	- Check the value and range of the frequency command. - Adjust <vL: Base frequency 1> to the motor. (Refer to [5. 2. 2])

Problems	Causes	Measures
The motor speed fluctuates during run.	- The load is large or small, and load fluctuation is large.	- Reduce the load fluctuation.
	- The inverter or motor used does not have a rating large enough to drive the load.	- Change the inverter and motor to large capacity.
	- The frequency command fluctuates.	- Check if the frequency command such as the analog signal changes.
	- Vector control is not performed properly when <Pt: V/f Pattern> is set to "3" or "9".	- Check the settings and conditions of the motor parameters and vector control. (Refer to [5. 3. 4])
Parameter settings cannot be changed.	- <F700: Parameter reading&writing access lockout> is set to "1" to "4" (Locked).	- Set <F700> to "0: Unlocked".
	- The password is set with <F738: Password setting>.	- Input the password to <F739: Password verification> to clear. (Refer to [6. 34. 1])
	- Input terminal functions: "200" to "203" (Parameter writing/reading locked) are assigned to one of the digital input terminals, and the input terminal is ON.	- Turn off the applicable input terminal.
	- For reasons of safety, some parameters cannot be changed during run.	- Refer to [6. 34. 1].

The following is how to deal with parameter setting-related problems.

Problems	Measures
You forget parameters which have been reset.	- You can search for all changed parameters and set. For details, refer to "Changed parameters search & edit <GrU>" in [4. 2. 1].
You want to return all changed parameters to their respective default settings.	- You can return all parameters to default settings. For details, refer to [5. 3. 9].





# 14 Maintenance and inspection

I

II



## WARNING



Mandatory  
action

- Perform daily inspection and periodic inspection on equipment.  
If you use the inappropriate inverter, not only will the three-phase motor not rotate correctly, but it will cause serious accidents such as overheating and burning out.

- Before inspection, perform the following steps.

(1) Turn off the power to the inverter.

(2) Wait at least 15 minutes and verify that the charge lamp is no longer lit.

(3) Use a tester that can measure DC voltages (800 VDC or more), and verify that the voltage to the DC main circuits between [PA/+] and [PC/-] is 45V or less, and verify that the residual voltage of AC main circuits cable is 45V or less.

Performing inspection without carrying out these steps can lead to electric shock.

When using the PM motor, please verify that the PM motor is stopped. While the PM motor is rotating even after the power is turned off, as a high voltage is generated in the output terminals [U/T1], [V/T2] and [W/T3] on the PM motor side, touching the output terminals will result in electric shock.

1

2

3

4

5

6

7

8

9

10

11

12

13

14

15

16

To prevent a failure due to the influence of the operating environment such as temperature, humidity, dust, or vibration, or to aging or lives of the used parts, perform daily inspection and periodical inspection.

## 14.1 Daily inspection and cleaning

The electronic parts are vulnerable to heat. Therefore, be sure to install the inverter in a well-ventilated, dust-free environment with low ambient temperature.

The purpose of the daily inspection is to maintain the environment and to find any sign of abnormal operation before a failure occurs by recording and comparing the operation data.

### 14.1.1 Checkpoints for daily inspection

Perform daily inspection according to the following items and table:

- Are any abnormalities found in the installation environment?
- Does the cooling system have any problems?
- Is unusual vibration or sound found?
- Is abnormal overheat or discoloration found?
- Is an unusual smell found?
- Is adhesion or accumulation of foreign substances (conductive substances) found?
- Is unusual vibration, sound, or overheat found in the motor?

Item to be inspected daily	Inspection procedure			Criteria and action
	Inspection item	Cycle	Check method	
Indoor environment	Dust	As required	Visual check	Eliminate any problems if any.
	Gas	As required	Smell check	
	Liquid drops such as water	As required	Visual check	Check for any trace of liquid.
	Room temperature	As required	Thermometer	Inverter ambient temperature: 60°C or less (Operation panel: 50°C or less)
Inverter unit and parts Peripheral devices	Vibration and noise	As required	Tactile check on the unit outer surface	<ul style="list-style-type: none"> <li>• If any abnormalities are found in the inverter unit, check the cooling fans, etc.</li> <li>• Check the peripheral devices (transformers, reactors, magnetic contactors, thermal relays, etc.) for abnormality. Stop operation as required.</li> </ul>
Operation data (output side)	Output current	As required	Moving-iron type AC Ammeter	<ul style="list-style-type: none"> <li>• To be within the rating</li> <li>• No large difference is to be found compared to the data for normal operation.</li> </ul>
	Output voltage*1	As required	Rectifier type AC voltmeter	
	Ambient temperature (at startup, during run, and at stop)	As required	Thermometer	

\*1 The voltage value may vary depending on the measurement device used. Therefore, be sure to use the same voltmeter for inspection, and record the indicated values.

### 14. 1. 2 Daily cleaning

To clean the inverter, use a soft cloth to slightly wipe off the dirt or stains on the inverter surface. If the dirt or stains persist, slightly wipe it off with a cloth dampened with neutral detergent or ethanol.

# 14



Important

- Do not use the following chemicals and solvents. Failure to do so results in damaged inverter molded parts (unit, plastic covers, etc.) or peeled coating.
  - Acetone
  - Benzen
  - Chloroform
  - Ethylene chloride
  - Ethyl acetate
  - Glycerin
  - Tetrachloroethane
  - Trichloroethylene
  - Xylene

## 14. 2 Periodical inspection

Perform periodical inspection once every three to six months depending on the operating conditions.

### WARNING



Mandatory action

- Before inspection, perform the following steps.
    - (1) Turn off the power to the inverter.
    - (2) Wait at least 15 minutes and verify that the charge lamp is no longer lit.
    - (3) Use a tester that can measure DC voltages (800 VDC or more), and verify that the voltage to the DC main circuits between [PA/+] and [PC/-] is 45V or less, and verify that the residual voltage of AC main circuits cable is 45V or less.
- Performing inspection without carrying out these steps can lead to electric shock. When using the PM motor, please verify that the PM motor is stopped. While the PM motor is rotating even after the power is turned off, as a high voltage is generated in the output terminals [U/T1], [V/T2] and [W/T3] on the PM motor side, touching the output terminals will result in electric shock.

### 14. 2. 1 Checkpoints for periodical inspection

The periodical inspection items and check methods are shown in the following table.

Periodical inspection item	Check method and action
Check the screw parts of the wiring terminals for looseness.	Tighten the screw parts of the wiring terminals with a screwdriver.
Check the caulked parts of the wiring terminals for any poor caulking.	Visually check the caulked parts for any trace of overheat.
Check the wiring for any damage.	Visual check
Clean dirt or dust.	Clean it with a vacuum cleaner.
Perform an insulation resistance test on the power terminal block.	Test only the power terminal block at 500 V mega to check that the insulation resistance is a few MΩ or more (the value is lower for the built-in noise filter models).
Check the input voltage and output voltage.	Periodically check the input-side voltage with a moving-iron type AC voltmeter (recommended).
	Periodically check the output-side voltage with a rectifier type AC voltmeter (recommended).
Check the ambient temperature.	Measure the ambient temperature of the inverter every time at startup, during run, and at stop.

#### ■ Notes for periodical inspection

When you use a vacuum cleaner for cleaning, pay attention to the vents, printed circuit boards, etc. Keep in mind that adhesion of dirt or dust may result in an unexpected accident. Be sure to keep them dust free.

Perform an insulation resistance test of the power terminal block only on the inverter as shown in the following figure.

- Remove the power supply wiring connected to the power terminal block and the wiring to the motor.
- Wire each power terminal.

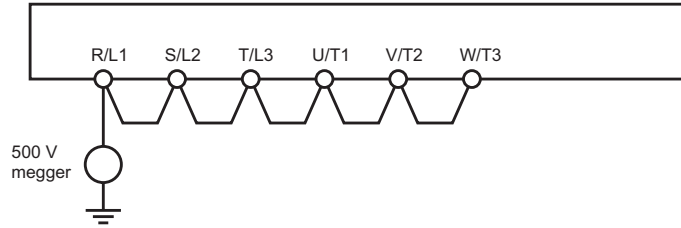

Also, remove the wiring of the power circuit output terminals [U/T1], [V/T2], and [W/T3], and perform an insulation resistance test only on the motor. When you perform an insulation resistance test on the peripheral circuits in the parts other than the motor, remove all the wiring connected to the inverter so that a test voltage will not be applied to the inverter.



Important

- Perform an insulation resistance test only on the power terminal block. Do not perform an insulation resistance test on the control terminals in the parts other than the power circuit, or on the circuit terminals mounted on the printed circuit board.
- Do not perform a dielectric test. Failure to do so may result in damaged internal parts.

## 14. 2. 2 Periodical inspection on the replacement parts

The inverter consists of a large number of electronic parts such as semiconductor devices. The following parts age because of the configurations or the physical properties. If they are left unused for a long time, the performance of the inverter will deteriorate, thus resulting in a failure. Be sure to perform periodical inspection for preventive maintenance.

For replacement of each replacement part, contact your Toshiba distributor. Do not replace the parts on your own for safety.



**WARNING**



Prohibited

- Do not replace parts. This will result in electric shock, fire and other injury. Please call your Toshiba distributor for repairs and replacement of expendable parts.



Important

- The replacement cycle of the parts are influenced by the ambient temperature and the use conditions. The replacement cycle of the parts listed here are based on the assumption that they will be used in an environment (without corrosive gas, oil mist, dust, and metal powder, etc.) at an ambient temperature within the specification.
- The design life expectancies and the standard replacement cycles do not warrant the lives.

### ■ Cooling fan inspection

The inspection items for the cooling fans are as follows:

- Are the cooling fans rotating stably?
- Is any unusual sound or vibration found?

The design life expectancies of the cooling fans that cool down the heat-generating parts are as follows:

VFAS3-2004P to 2550P,

VFAS3-4004PC to 4132KPC: Design life expectancy 10 years

VFAS3-4160KPC to 4280KPC: Design life expectancy 5 years (9 years for inner air fan)

\* Average ambient temperature 40°C, load factor 80% or less, 24-hour operation per day

Also, replace the fans when unusual sound or vibration is found.

For replacement of the cooling fans, contact your Toshiba distributor.

### ■ Smoothing aluminum electrolytic capacitor inspection

The inspection items for the smoothing aluminum electrolytic capacitor are as follows:

- Is liquid leak found?
- Is the safety valve lifted?

The design life expectancy of the smoothing aluminum electrolytic capacitor is 10 years.

\* Average ambient temperature 40°C, load factor 80% or less, 24-hour operation per day

For replacement of the smoothing aluminum electrolytic capacitor, contact your Toshiba distributor.

The inverter unit may need to be replaced depending on the capacity because the smoothing aluminum electrolytic capacitor is mounted on the printed circuit board.

#### Memo

- You can check the parts replacement alarm and output signals in [Monitor mode]. For details, refer to [8. 1. 1].
- The design life expectancy of the smoothing aluminum electrolytic capacitor becomes shorter at high ambient temperature, and becomes longer at low ambient temperature.

■ **Standard replacement cycle of the other principal parts**

The estimated parts replacement cycles are shown in the following figure. They are based on the assumption that they will be used under normal use conditions (average ambient temperature of 40°C, load factor of 80% or less, 24-hour operation per day, with no corrosive gas, oil mist, dust, metal powder, etc. present). These replacement cycles are not the lives of the parts. They are based on the assumption that more parts will become abnormal when they are used over these cycles.

Part name	Standard replacement cycle* <sup>1</sup>	Replacement method
Relays	-	To be determined by inspection
Aluminum electrolytic capacitor on the printed circuit board	10 years* <sup>2</sup>	Replace with a new one. (To be determined by inspection)
Battery CR2032* <sup>3</sup> (used in the operation panel)	The remaining capacity of the battery is indicated into the LCD screen with icons (see 3. 1. 2)	Replace with a new one.

\*1 The replacement cycles greatly vary depending on the operating environment.  
 \*2 It is based on the case where the inverter output current is 80% of the inverter rated current.  
 \*3 Use CR2032EC (Toshiba).

**14. 2. 3 How to replace the battery**

- 1 Remove the operation panel from the inverter. Refer to [10. 3. 8]
- 2 Open the slot cover at bottom (left side) of operation panel



- 3 Eject the battery by using insulated tool (to avoid short-circuit by remaining charge)  
For disposal of battery, see [16]



- 4 Insert new battery, at that time take care the polarity.

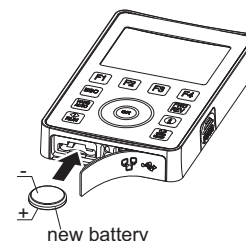

- 5 Close the slot cover  
Then, clock setting is needed, because the clock is not kept by replacing the battery  
Refer to E6582110 for setting.

## 14.3 In case of a failure

Should a failure occurs, contact your Toshiba distributor. Before contact, check the information on the name plate attached on the right side of the inverter unit, and presence or absence of the optional parts to inform the distributor of them as well as inverter problems.

## 14.4 Cautions for storage

If you store the inverter temporarily or for a long time after purchase, follow the instructions below.

### (1) Storage location

Store the inverter indoors. Avoid to be exposed to direct sunlight, corrosive, explosive or flammable gases, salt, oil mist, dust, metal powder, vapor or condensation.  
Storage temperature and Relative humidity are shown in the table below.

### (2) Periodical check

If no power is supplied to the inverter for a long time, the performance of its main circuit smoothing aluminum electrolytic capacitor declines.  
When leaving the inverter unused for a long time, energize it for an hour or more each without load in accordance with the table below, to recover the performance of the electrolytic capacitor. Then check the function of the inverter.

	Storage temperature [°C]	Relative humidity	how to recover the performance of the electrolytic capacitor
Short-term Storage (within one month such as during transportation)	-25 to 70	within 95%	Supplying power without load is not required.
Long-term Storage (exceeding one month)	-10 to 40	within 90%	Supply power once every two years for an hour or more.





# 15 | Warranty

I

II

Any part of the inverter that proves defective will be repaired and adjusted free of charge under the following conditions:

**(1) This warranty applies only to the inverter main unit.**

**(2) Any part of the inverter which fails or is damaged under normal use within twelve months from the date of delivery shall be repaired free of charge.**

**(3) For the following kinds of failure or damage, the repair cost shall be borne by the customer even within the warranty period.**

- Failure or damage caused by improper or incorrect use or handling, or unauthorized repair or modification of the inverter
- Failure or damage caused by the inverter falling or an accident during transportation after the purchase
- Failure or damage caused by fire, salty damage, corrosive gas, earthquake, storm or flood, lightning, abnormal voltage supply, or other natural disasters
- Failure or damage caused by the use of the inverter for any purpose or application other than the intended one

**(4) All expenses incurred by Toshiba for on-site services shall be charged to the customer, unless a service contract is signed beforehand between the customer and Toshiba, in which case the service contract has priority over this warranty.**

1

2

3

4

5

6

7

8

9

10

11

12

13

14

15

16



# 16 Disposal

I

II

## CAUTION



Mandatory  
action

- If you dispose of the inverter, have it done by a specialist in industry waste disposal.\*<sup>1</sup>  
If you dispose of the inverter by yourself, this can result in explosion of capacitor or production of noxious gases, resulting in injury.
- When you dispose of the operation panel, insulate the terminals of the lithium battery by wrapping the terminals with tapes.  
If the terminals contact with other metal or batteries, this will result in heat rising up, explosion, and fire.

\*<sup>1</sup> Persons who specialize in the processing of waste and known as "industrial waste product collectors and transporters" or "industrial waste disposal persons". Please observe any applicable law, regulation, rule or ordinance for industrial waste disposal.

When you dispose of your old inverter, ask a specialist in industry waste disposal. Failure to do so results in injuries due to an explosion of the capacitor or generation of noxious gas. Also, when you dispose of the operation panel, wrap the terminals of the lithium battery with tape, etc. to insulate it. If the terminals come in contact with other metal parts or batteries, heat generation, an explosion, or firing may occur.

1

2

3

4

5

6

7

8

9

10

11

12

13

14

15

16





---

# TOSHIBA

## **TOSHIBA INDUSTRIAL PRODUCTS AND SYSTEMS CORPORATION**

Motor Drive Division  
580, Horikawa-cho, Saiwai-Ku, Kawasaki, Kanagawa  
212-0013 Japan  
TEL : +81-44-520-0828  
FAX : +81-44-520-0508

## **TOSHIBA INTERNATIONAL CORPORATION**

13131 West Little York RD., Houston  
TX 77041, U.S.A  
TEL:+1-713-466-0277  
FAX:+1-713-466-8773

## **TOSHIBA AMERICADO SUL LTDA.**

Avenida Ibirapuera, 2332, Torre I,  
5° floor City of Sao Paulo Brasil  
TEL:+55-11-4083-7900  
FAX:+55-11-4083-7910

## **TOSHIBA INDUSTRIAL PRODUCTS AND SYSTEMS SHANGHAI CORPORATION**

Room No.906, Raffles City (Office Tower), No. 268,  
Xizang Middle Road, Huangpu District, Shanghai,  
P.R.China  
TEL:+86-21-6361-3300  
FAX:+86-21-6373-1760

## **TOSHIBA ELECTRONIC COMPONENTS TAIWAN CORPORATION**

12F, No.8, Min Sheng E. Rd. Sec. 3, Taipei 10480,  
Taiwan  
TEL:+886-2-2508 9988  
FAX:+886-2-2508 9997

## **TOSHIBA ASIA PACIFIC PTE LTD**

20 Pasir Panjang Road #13-27/28,  
Mapletree Business City, Singapore 117439  
TEL:+65-6297-0990  
FAX:+65-6305-5561

## **TOSHIBA INTERNATIONAL CORPORATION PTY. LTD.**

11 A Gibbon Road, Winston Hills, Sydney, NSW 2153,  
Australia  
TEL:+61-2-8867-6200  
FAX:+61-2-9624-7104

## **TOSHIBA INDIA PRIVATE LIMITED**

3RD Floor, Building No.10, Tower B, Phase-II,  
DLF Cyber City, Gurgaon-12202, India  
TEL:+91-124-4996600  
FAX:+91-124-4996665

## **TOSHIBA GULF FZE**

P.O.Box 61028, Jebel Ali, Free Zone, Dubai, U.A.E  
TEL:+971-4-8817789  
FAX:+971-4-8818985

## **TOSHIBA RUS LLC**

Kievskaya st, 7, entrance 7, floor 12, Moscow,  
121059, Russian Federation  
TEL:+7-495-642-8929  
FAX:+7-495-642-8908

## **TOSHIBA AFRICA (PTY) LTD – SOUTH AFRICA**

10th Floor, Sandton Office Towers, 5th Street,  
Sandton, 2196, South Africa  
TEL:+27-11-305-2820  
FAX:+27-11-326-6074