

HGL Open Part Number	Schematic Drawing #	Approx Weight (LBS)
HGL0050AW0S0000	30586-S	130
HGL0050AW0C0000	30586-C	135
HGL0050AW0S*000	30586-PQS	133
HGL0050AW0C*000	30586-PQC	138

Unit Specifications						
HP	kVar	Harmonic	Volt	Maximum Amps (A)	HZ.	Phase
50	8	5TH	480	65	60	3

HGL Enclosed Type 1 Part Number	Schematic Drawing #	Approx Weight (LBS)
HGL0050AW1S0000	30586-S	195
HGL0050AW1C0000	30586-C	200
HGL0050AW1S*000	30586-PQS	196
HGL0050AW1C*000	30586-PQC	201

* = Communications Option

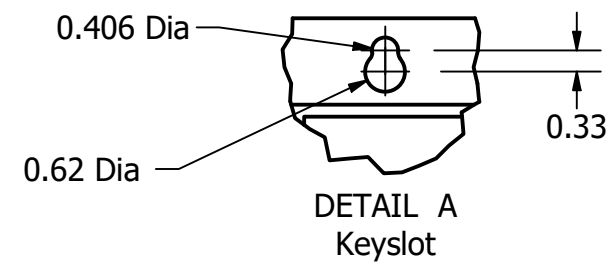

Note: For Torque Information See IOM Manual Customer Connections. L1, T1, L2, T2, L3, T3 Wire Range: 1 AWG to 22 AWG.

Ground Lug Wire Range: 1/0 to 14 AWG.

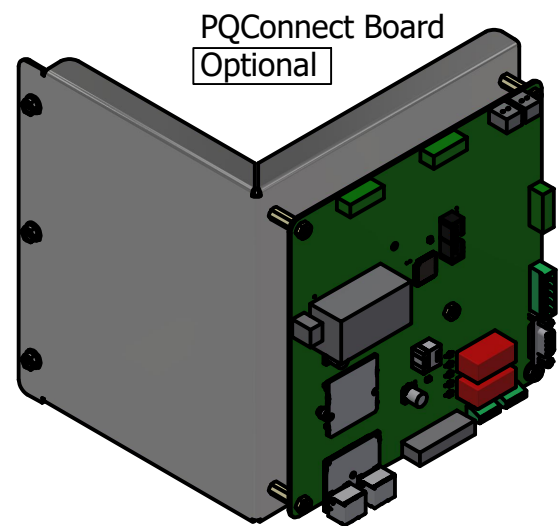
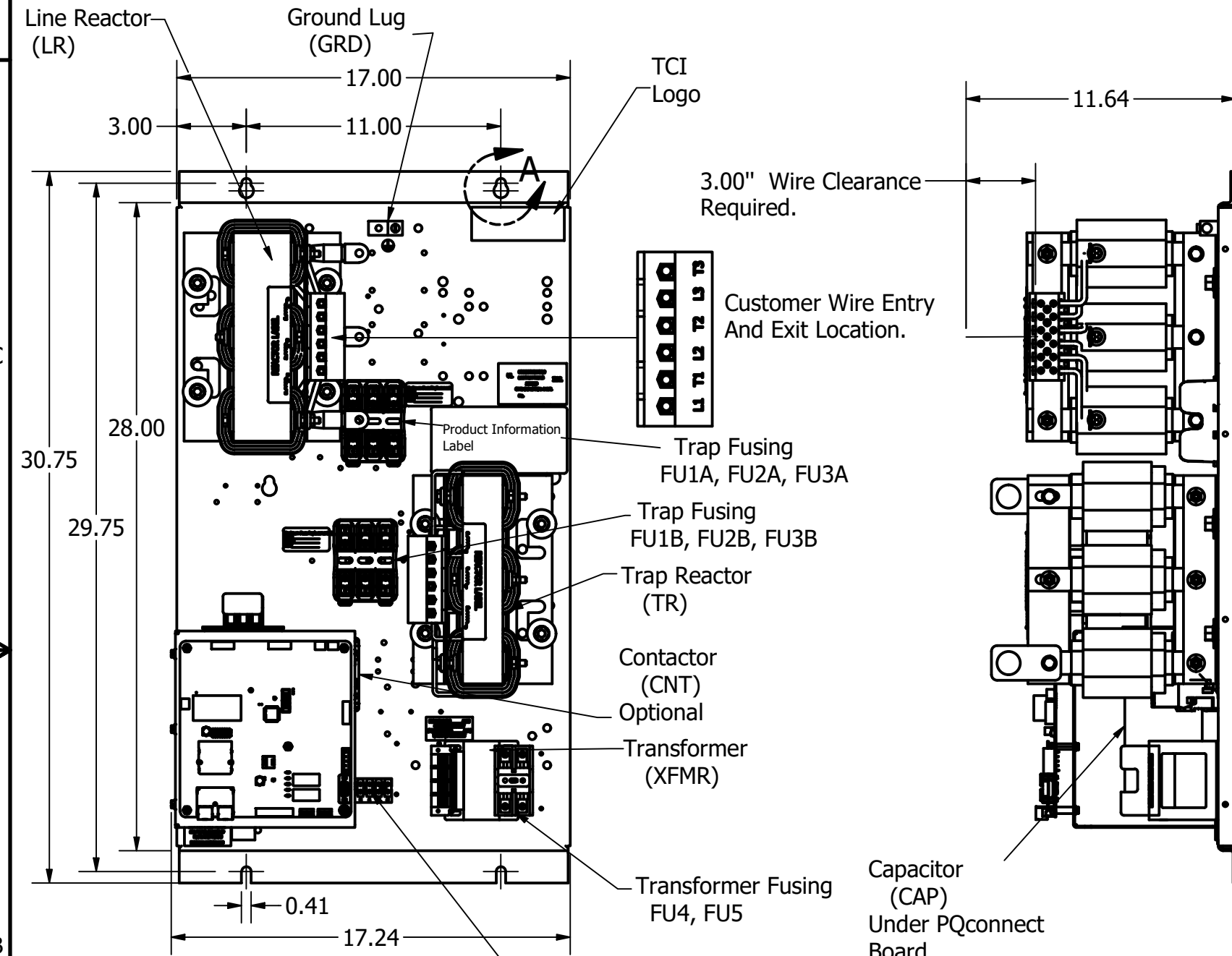

Terminal Block Location When Supplied.

Note: Customer is responsible for proper cooling of filter components on open panels. Capacitors Maximum Ambient 50°C.

Components	HGL0050AW----			
	0S0000/1S0000	0C0000/1C0000	0S*000/1S*000	0C*000/1C*000
Line Reactor (LR)	X	X	X	X
Trap Reactor (TR)	X	X	X	X
Capacitor (Cap)	X	X	X	X
Trap Fusing, FU1, FU2, FU3	X	X	X	X
Contactor (CNT)		X	X	X
Transformer (XFMR)		X	X	X
XFMR Fusing, FU4, FU5		X	X	X
PQConnect Board			X	X

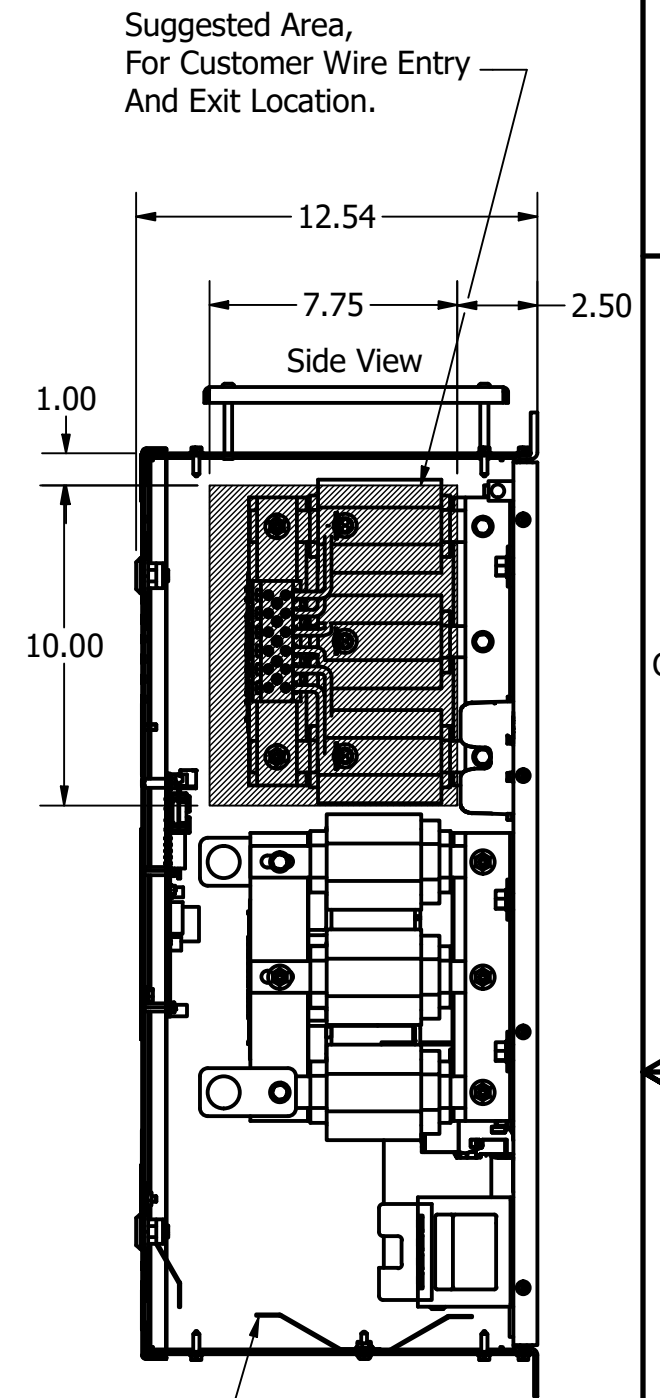
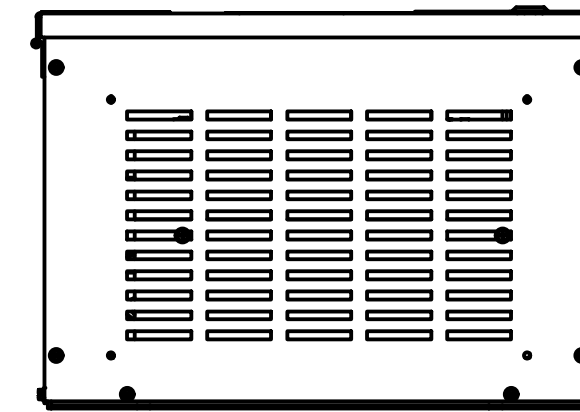
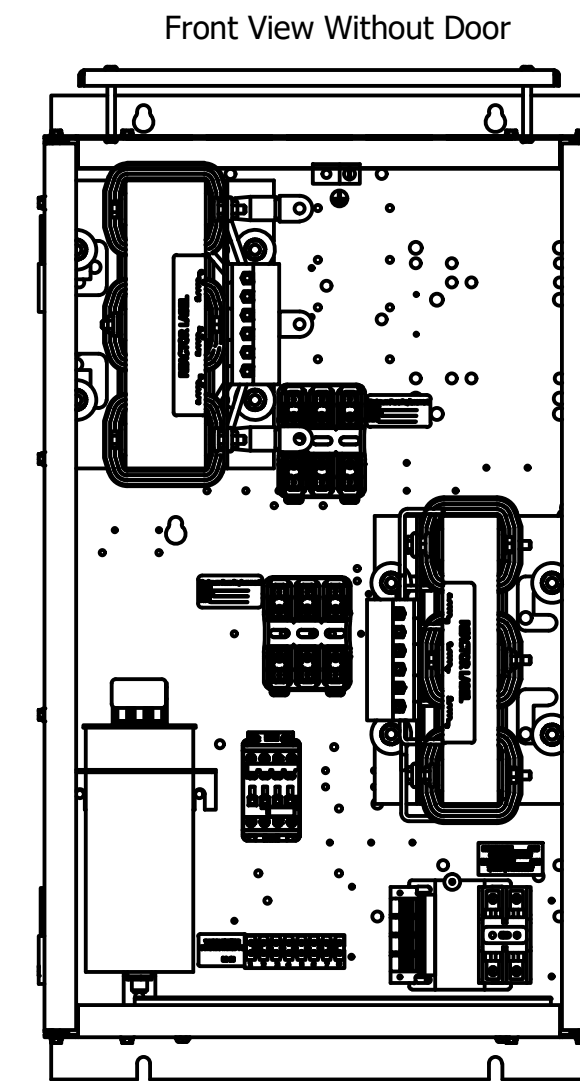
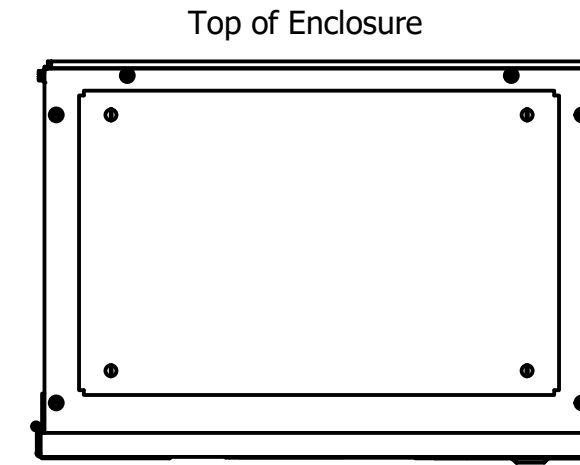
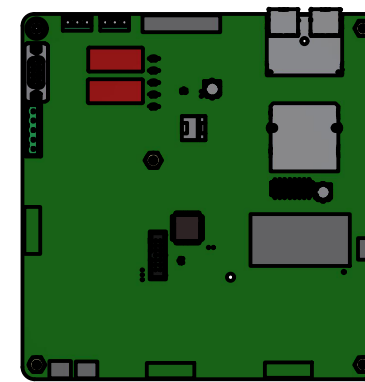
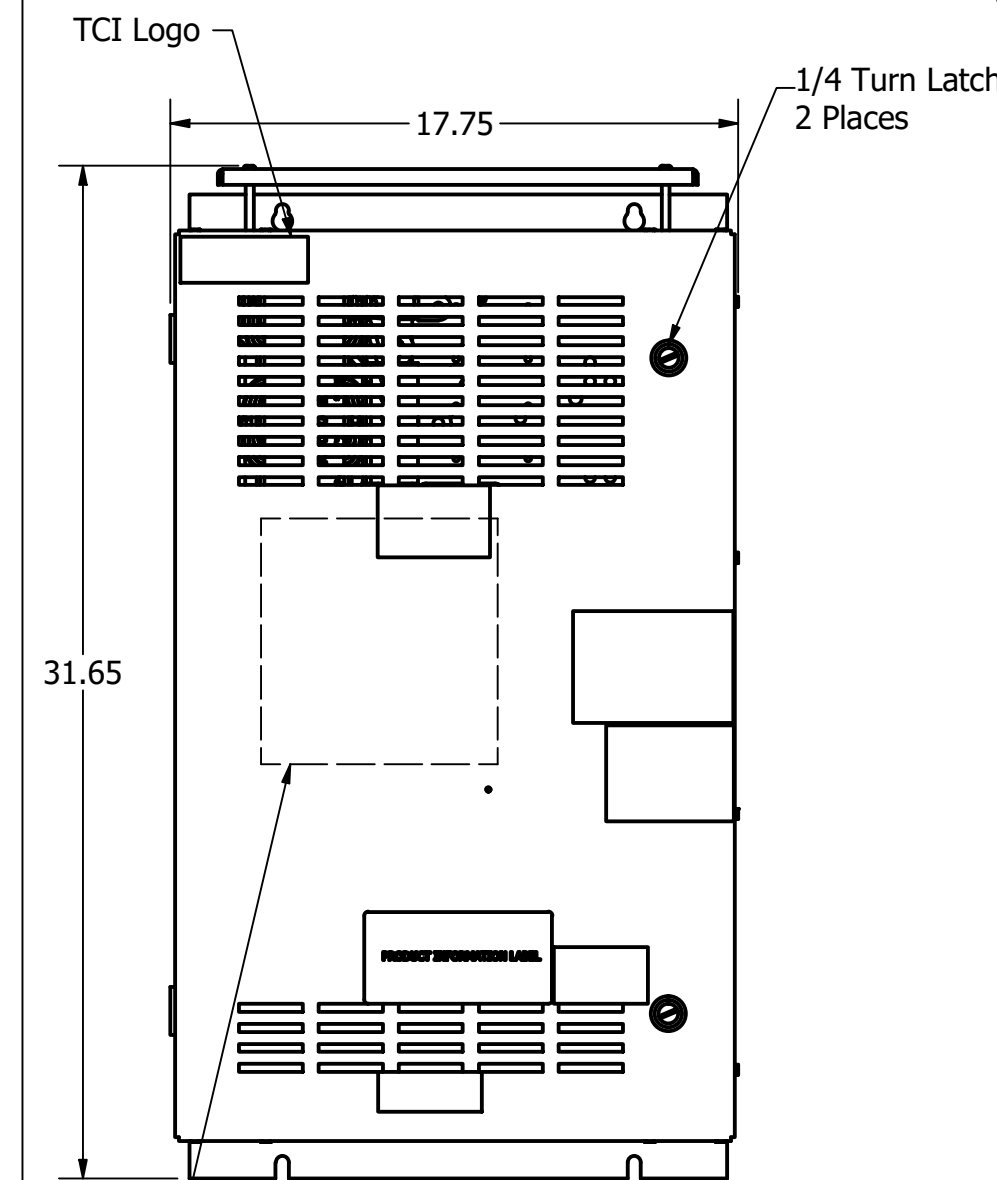

UL Required Shields 3 Places.

Customer Is Responsible For Installation to Meet All National And Local Electrical Codes.

Material(s) Shall be RoHS Compliant

THE INFORMATION AND DESIGNS CONTAINED IN THIS DRAWING ARE CONFIDENTIAL AND THE PROPRIETARY PROPERTY OF ALLIED MOTION TECHNOLOGIES INC. AND ITS SUBSIDIARIES. NEITHER THIS DESIGN NOR ANY INFORMATION CONTAINED IN THIS DRAWING MAY BE REPRODUCED OR DISCLOSED TO OTHERS WITHOUT THE EXPRESS WRITTEN CONSENT OF ALLIED MOTION TECHNOLOGIES INC. AND ITS SUBSIDIARIES.

NO	REVISION	DATE	BY	TOLERANCES (EXCEPT AS NOTED)
D	6024, Add PQ Option	8/26/2022	GJS	DECIMAL .XX ± .25 .XXX ± .10
C	5653 GE to ABB CNT Change	11/9/2021	DSW	FRACTIONAL ± 1/16
B	PQConnect Board Added.	2/27/19	DSW	ANGULAR ± 1°

 W132N10611 Grant Drive
 Germantown, WI 53022
 © 2022 TCI, LLC
 HarmonicGuard Low Capacitance
 HGL, 50HP, 480/3/60, Open and Type 1.
 107015DG
 SCALE: 1/8
 DATE: 3/30/17
 APRVD: DSW
 SIZE: C
 SHT 1 OF 1