



**KMG® MotorGuard High Performance Output
Sine Wave Filter Installation, Operation, and Maintenance
Manual**

Including information for:

PQconnect



TCI, LLC
W132 N10611 Grant Drive
Germantown, Wisconsin 53022

Phone: 414-357-4480
Fax: 414-357-4484
Helpline: 800-824-8282
Web Site: www.transcoil.com

© 2021 TCI, LLC All rights reserved

Product No: 24362 Effective: 06-01-2021 Version: 1.3
--

Revision	Description	Date
1.0	Release	05/17/2014
1.1	Updates to formatting and layout	02/23/2018
1.2	Addition of PQconnect	02/23/2020
1.3	Edits to PQconnect; addition of PQvision	06/01/2021

Table of Contents

- Table of Contents 5**
- 1.0 Safety 1**
 - Safety Instructions Overview 1
 - Warnings and Cautions 1
 - General Safety Instructions 2
- 2.0 General Information 3**
 - Intended Audience 3
 - Receiving Inspection 3
 - Storage Instructions 3
 - TCI Limited Warranty Policy 3
 - Product Description 5
 - Nameplate Data 6
 - Model Number Encoding 7
 - Standard Product Ratings and Dimension Tables 8
 - Product Technical Specifications 14
- 3.0 Installation Guidelines 16**
 - Pre-installation Planning 16
 - Select a Suitable Location 16
 - Mounting 17
 - Wiring 18
 - Fuses 21
 - Installation Checklist 22
- 4.0 Operation 24**
 - Variable Frequency Drive Settings 24
 - Start Up (Commissioning) 24
 - Before Applying Power for the First Time 24
 - Before Operating the VFD for the First Time 24
 - Drawings 24
- 5.0 PQconnect 25**

Product Description	25
Modbus RTU	25
PQvision PC application Screen Elements	26
PQvision PC Home Screen Elements	26
PQvision PC Settings Screen Elements.....	27
PQvision PC Status Detection History Elements	30
Modbus RTU Connections.....	31
Modbus Input and Output Register Maps	31
Waveform Data	41
PQconnect Hardware	42
USPTL4 RS485 Converter Dip Switch settings	43
Example Setup Instructions to Read Data from the PQconnect Unit	43
Example Setup Instructions to Write Data to the PQconnect Unit.....	44
PCB Connections	45
Troubleshooting	46
Receiving Inspection.....	46
Connectivity Board Problem	47
Communication Problems	48
PCB Calibration Process	49
Debug Status Conditions.....	50
Debug Fault conditions.....	51
6.0 Maintenance and Service	52
Evaluating MotorGuard Performance.....	52
MotorGuard Reliability and Service Life	52
Periodic Maintenance.....	52
Replacement Parts	52
Factory Contacts and Tech Support	52

1.0 Safety

Safety Instructions Overview

This section provides the safety instructions which must be followed when installing, operating and servicing the KMG MotorGuard Filter. If neglected, physical injury or death may follow, or damage may occur to the MotorGuard or equipment connected to the MotorGuard. The material in this chapter must be read and understood before attempting any work on, or with, the product.

The MotorGuard is intended to be connected to the output terminals of a variable frequency drive (VFD). An AC motor is connected to the output terminals of the MotorGuard and receives power from the VFD through the MotorGuard. The instructions, and particularly the safety instructions, for the VFD, motor and any other related equipment must be read, understood and followed when working on any of the equipment.

Warnings and Cautions



This manual provides two types of safety instructions.

Warnings caution readers about conditions, which can, if proper steps are not taken, lead to a serious fault condition, physical injury, or death.

Cautions are used to draw attention to instructions. Failure to properly follow such instructions may lead to a malfunction and possible equipment damage.

Warnings

Readers are informed of situations that can result in serious physical injury and/or serious damage to equipment with warning statements marked with the following symbols:

<p>Warning</p> 	<p>Dangerous Voltage Warning: warns of situations in which a high voltage can cause physical injury and/or equipment damage. The text next to this symbol describes ways to avoid the danger.</p>
<p>Warning</p> 	<p>General Warning: warns of situations that can cause physical injury and/or equipment damage by means other than electrical. The text next to this symbol describes ways to avoid the danger.</p>
<p>Warning</p> 	<p>Electrostatic Discharge Warning: warns of situations in which an electrostatic discharge may damage equipment. The text next to this symbol describes ways to avoid the danger.</p>









Cautions

Readers are informed of situations that can lead to a malfunction and possible equipment damage with caution statements:

<p>Caution</p> 	<p>General Caution: identifies situations that can lead to a malfunction and possible equipment damage. The text describes ways to avoid the situation.</p>
---	---

General Safety Instructions

These safety instructions are intended for all work on the MotorGuard. Additional safety instructions are provided at appropriate points on other sections of this manual.

<p>Warning</p> 	<p>Be sure to read, understand, and follow all safety instructions.</p>
<p>Warning</p> 	<p>Only qualified electricians should carry out all electrical installation and maintenance work on the MotorGuard.</p>
<p>Warning</p> 	<p>All wiring must be in accordance with the National Electrical Code (NEC) and/or any other codes that apply to the installation site.</p>
<p>Warning</p> 	<p>Disconnect all power before working on the equipment. Do not attempt any work on a powered MotorGuard.</p>
<p>Warning</p> 	<p>The MotorGuard, VFD, motor, and other connected equipment must be properly grounded.</p>
<p>Warning</p> 	<p>The MotorGuard receives power from two or more sources. Three-phase power from the output terminals of the VFD is connected to the main input terminals of the MotorGuard.</p> <p>Power from a single-phase 120, 240 or 480 volt supply is connected to the MotorGuard for the cooling fans and PQconnect. Do not connect fan circuit to the output of VFD, separate line voltage needs to be wired to the filter. Damage to the filter will occur if fans are left unpowered or connected to VFD output.</p> <p>The PQconnect alarm contacts may be connected to a circuit that receives power from another source.</p> <p>All of these sources of power must be disconnected before working on the MotorGuard.</p>
<p>Warning</p> 	<p>After switching off the power, always allow 5 minutes for the capacitors in the MotorGuard and in the VFD to discharge before working on the MotorGuard, the VFD, the motor, or connecting wiring. It is good practice to check with a voltmeter to make sure that all sources of power have been disconnected and that all capacitors have discharged before beginning work.</p>
<p>Warning</p> 	<p>The VFD output terminals and the motor cables are at a dangerously high voltage when power is applied to the VFD regardless of motor operation.</p>

2.0 General Information

Thank you for selecting the KMG MotorGuard High Performance Output Filter. TCI has produced this filter for use in many PWM variable frequency drive (VFD) applications that require low distortion sine wave output power. This manual describes how to install, operate, and maintain the MotorGuard filter.

<p>Caution</p> 	<p>This manual provides general information describing your MotorGuard filter. More specific information is provided by the drawings shipped with the unit. Be sure to carefully review the information provided by these drawings. Information provided by the drawings shipped with the unit takes precedence over the information provided in this manual.</p>
---	---

Intended Audience

This manual is intended for use by all personnel responsible for the installation, operation, and maintenance of the MotorGuard. Such personnel are expected to have knowledge of electrical wiring practices, electronic components, and electrical schematic symbols.

Receiving Inspection

The MotorGuard has been thoroughly inspected and functionally tested at the factory and carefully packaged for shipment. When you receive the unit, you should immediately inspect the shipping container and report any damage to the carrier that delivered the unit. Verify that the part number of the unit you received is the same as the part number listed on your purchase order.

Storage Instructions

If the MotorGuard is to be stored before use, be sure that it is stored in a location that conforms to published storage humidity and temperature specifications stated in this manual. Store the unit in its original packaging.

TCI Limited Warranty Policy

TCI, LLC (“TCI”) warrants to the original purchaser only that its products will be free from defects in materials and workmanship under normal use and service for a period originating on the date of shipment from TCI and expiring at the end of the period described below:

Product Family	Warranty Period
KLR, KDR	For the life of the drive with which they are installed.
HGA, , KMG, MSD, V1K	One (1) year of useful service, not to exceed 18 months from the date of shipment.
PFGuard, HGP, HGL, HSD, KRF	Three (3) years from the date of shipment.
KCAP, KTR	Five (5) years from the date of shipment.
All Other Products	One (1) year of useful service, not to exceed 18 months from the date of shipment.

The foregoing limited warranty is TCI’s sole warranty with respect to its products and TCI makes no other warranty, representation, or promise as to the quality or performance of TCI’s products. THIS EXPRESS LIMITED WARRANTY IS GIVEN IN LIEU OF AND EXCLUDES ANY AND ALL EXPRESS OR IMPLIED WARRANTIES INCLUDING, WITHOUT LIMITATION, ANY IMPLIED WARRANTY OF MERCHANTABILITY OR FITNESS FOR A PARTICULAR PURPOSE.

This warranty shall not apply if the product was:

- a) Altered or repaired by anyone other than TCI;
- b) Applied or used for situations other than those originally specified; or
- c) Subjected to negligence, accident, or damage by circumstances beyond TCI's control, including but not limited to, improper storage, installation, operation, or maintenance.

If, within the warranty period, any product shall be found in TCI's reasonable judgment to be defective, TCI's liability and the Buyer's exclusive remedy under this warranty is expressly limited, at TCI's option, to (i) repair or replacement of that product, or (ii) return of the product and refund of the purchase price. Such remedy shall be Buyer's sole and exclusive remedy. TCI SHALL NOT, IN ANY EVENT, BE LIABLE FOR INCIDENTAL DAMAGES OR FOR CONSEQUENTIAL DAMAGES INCLUDING, BUT NOT LIMITED TO, LOSS OF INCOME, LOSS OF TIME, LOST SALES, INJURY TO PERSONAL PROPERTY, LIABILITY BUYER INCURS WITH RESPECT TO ANY OTHER PERSON, LOSS OF USE OF THE PRODUCT OR FOR ANY OTHER TYPE OR FORM OF CONSEQUENTIAL DAMAGE OR ECONOMIC LOSS.

The foregoing warranties do not cover reimbursement for removal, transportation, reinstallation, or any other expenses that may be incurred in connection with the repair or replacement of the TCI product.

The employees and sales agents of TCI are not authorized to make additional warranties about TCI's products. TCI's employees and sales agent's oral statements do not constitute warranties; these shall not be relied upon by the Buyer and are not part of any contract for sale. All warranties of TCI embodied in this writing and no other warranties are given beyond those set forth herein.

TCI will not accept the return of any product without its prior written approval. Please consult TCI Customer Service for instructions on the Return Authorization Procedure.

Product Description

The MotorGuard is a low-pass sine wave filter designed and developed by TCI to deliver conditioned power to motor loads driven by PWM drives at a variety of lead lengths. The MotorGuard is available for 460/480 volt and 575/600 volt systems.

The MotorGuard is a passive filter connected in series with the output terminals of the variable frequency drive. It is designed to remove the carrier frequency distortion from the output voltage waveform. The use of this low-pass, L-R-C device will result in a nearly pure sine wave voltage profile. This design will reduce the effects of the reflected wave phenomenon, (dv/dt), such as insulation damage or premature failure in motors, transformers and VFD output cables. The MotorGuard will also reduce the effects of stray high frequency harmonic currents, thereby reducing VFD ground fault problems and noise interference in transducer signals.

The MotorGuard is available in two package configurations: Industrial and GP. The Industrial filter is a stand-alone device that can be furnished in its own enclosure and mounted adjacent to the VFD, and is also available on an open panel for mounting within an enclosure provided with the VFD or other equipment. The GP filter is furnished in its own enclosure and mounted adjacent to the VFD.

The MotorGuard is suitable for all lead lengths extending as far as 15,000 feet.

The MotorGuard consists of the following standard features and components:

- An R-L-C power filter circuit with:
 - A TCI 3-phase reactor specifically designed for the MotorGuard
 - Power resistors
 - High-endurance, harmonic-rated capacitors
- Bleeder resistors to ensure safe capacitor discharge upon filter shutdown.
- Compression terminals for ease and integrity of all power wiring.
- Cooling fans to ensure adequate cooling and safe operating temperatures.
- PQconnect monitoring and communications (optional)

Nameplate Data

The figure below shows an example of a MotorGuard nameplate. The following information is marked on the nameplate:

- Part number: encoded model number explained on the following page
- FLA: the rated continuous operating current (RMS amps)
- System Voltage: the maximum VFD output voltage (fundamental)
- Hz: the maximum VFD output frequency (fundamental)
- Phase: 3 – The MotorGuard is designed for use only with 3 phase motors.
- Drawing #: outline and mounting dimension of filter
- Schematic #: schematic diagram of filter
- Manufacturing #: for TCI internal use
- Enclosure Type: Industrial filters are open panel construction or UL Type 1 enclosed. GP filters are NEMA 1 or NEMA 3R enclosed.

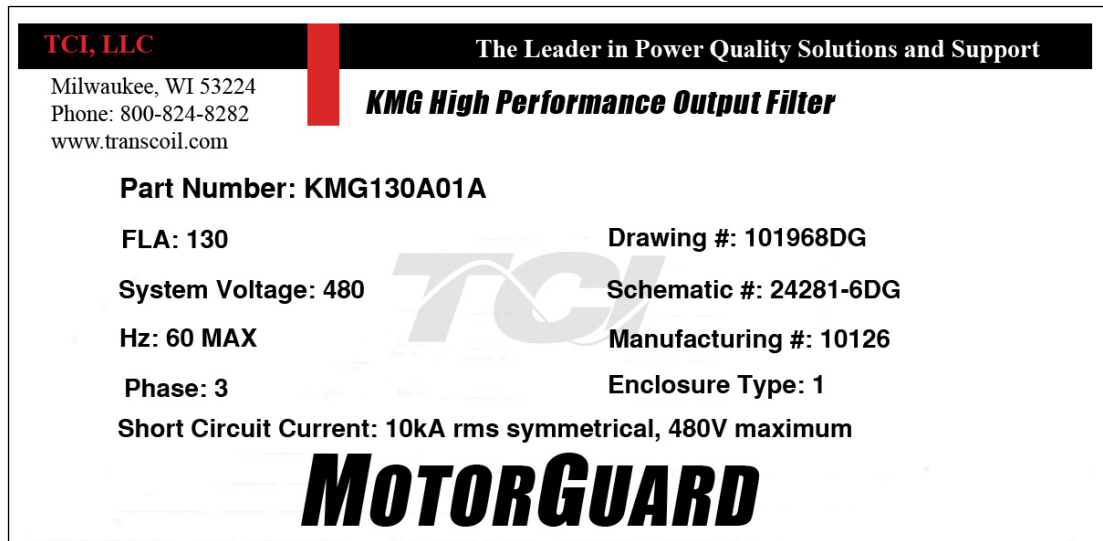

Figure 1: Example of MotorGuard Nameplate

Model Number Encoding

Figure 2 and Figure 3 identify the significance of each character in the MotorGuard model number. The example model number, KMG130A01P designates an Industrial MotorGuard that is rated 130 amps, 480 volts, UL Type 1 enclosure, with the PQconnect option.

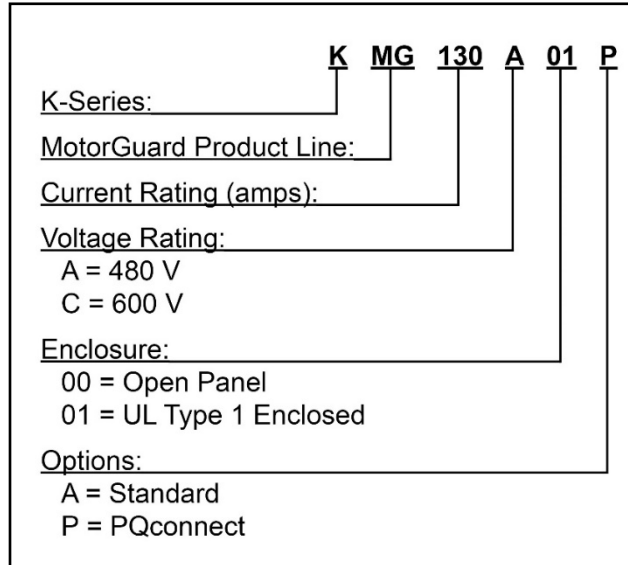

Figure 2: MotorGuard Model Number Encoding – Industrial Version

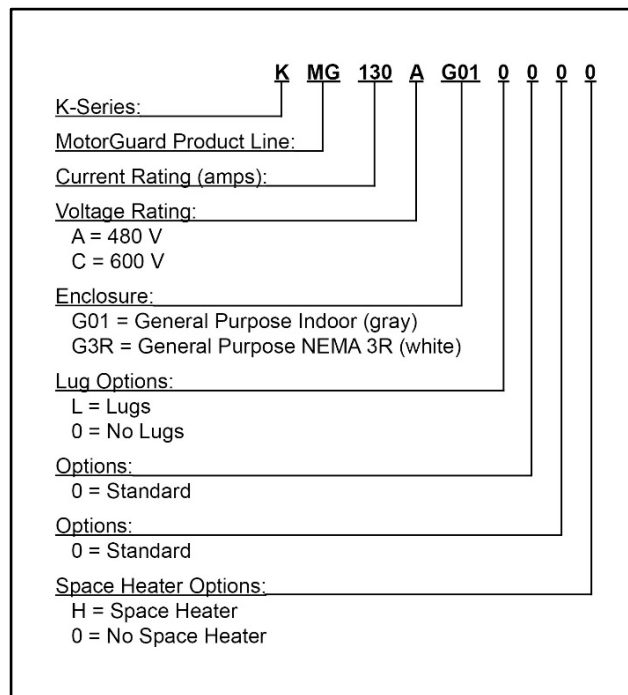

Figure 3: MotorGuard Model Number Encoding – General Purpose Version (Legacy Product)

The MotorGuard has a current rating rather than a horsepower rating. The rating and dimension tables in the following section list the nominal horsepower ratings corresponding to the current ratings of the standard models.

Standard Product Ratings and Dimension Tables

The following tables list the ratings and dimensions of the standard MotorGuard models.

Table 1: Industrial 480 Volt Models on Open Panels

Model Number	Nominal Horsepower	Current Rating (amps)	Heat Loss (Watts)	Weight (lbs.)	Height (in.)	Width (in.)	Depth (in.)
KMG8A00_	5	8	300	60	30.75	17.00	11.75
KMG12A00_	7.5	12	350	60			
KMG16A00_	10	16	400	70			
KMG23A00_	15	23	550	75			
KMG30A00_	20	30	650	85			
KMG35A00_	25	35	750	85			
KMG45A00_	30	45	850	100			
KMG55A00_	40	55	1000	115	56.00	17.00	11.75
KMG65A00_	50	65	1100	160			
KMG80A00_	60	80	1550	175			
KMG110A00_	75	110	1700	195			
KMG130A00_	100	130	2050	200			
KMG160A00_	125	160	2450	250			
KMG200A00_	150	200	3300	255			
KMG250A00_	200	250	3700	445	60.00	32.00	14.75
KMG305A00_	250	305	4700	460			
KMG362A00_	300	362	4650	475			
KMG420A00_	350	420	5400	580	60.00	32.00	16.38
KMG480A00_	400	480	6050	635			
KMG600A00_	500	600	7350	645			
KMG750A00_	600	750	8800	760	60.00	32.00	17.75

Table 2: Industrial 480 Volt Models in UL Type 1 Enclosures

Model Number	Nominal Horsepower	Current Rating (amps)	Weight (lbs.)	Height (in.)	Width (in.)	Depth (in.)
KMG8A01_	5	8	110	31.38 Wall Mounted	17.50	12.14
KMG12A01_	7.5	12	110			
KMG16A01_	10	16	120			
KMG23A01_	15	23	125			
KMG30A01_	20	30	140			
KMG35A01_	25	35	140			
KMG45A01_	30	45	155			
KMG55A01_	40	55	170			
KMG65A01_	50	65	245	56.00 Wall Mounted	17.52	16.40
KMG80A01_	60	80	260			
KMG110A01_	75	110	280			
KMG130A01_	100	130	300			
KMG160A01_	125	160	340			
KMG200A01_	150	200	345			
KMG250A01_	200	250	770	76.50 Free Standing	36.00	24.00
KMG305A01_	250	305	790			
KMG362A01_	300	362	800			
KMG420A01_	350	420	915			
KMG480A01_	400	480	970			
KMG600A01_	500	600	975			
KMG750A01_	600	750	1085			

Table 3: Industrial 600 Volt Models on Open Panels

Model Number	Nominal Horsepower	Current Rating (Amps)	Heat Loss (Watts)	Weight (lbs.)	Height (in.)	Width (in.)	Depth (in.)
KMG8C00_	5	8	400	60	30.75	17.00	11.75
KMG10C00_	7.5	10	400	65			
KMG12C00_	10	12	400	70			
KMG20C00_	15	20	550	75			
KMG25C00_	20	25	700	85			
KMG28C00_	25	28	750	90			
KMG35C00_	30	35	800	100			
KMG45C00_	40	45	950	115			
KMG55C00_	50	55	1200	160	56.00	17.00	11.75
KMG65C00_	60	65	1600	175			
KMG80C00_	75	80	1650	195			
KMG110C00_	100	110	2250	225			
KMG130C00_	125	130	2300	250	56.00	17.00	14.78
KMG160C00_	150	160	2500	260			
KMG200C00_	200	200	3500	450	60.00	32.00	14.75
KMG250C00_	250	250	4500	460			
KMG305C00_	300	305	5100	475			
KMG362C00_	350	362	6100	580			
KMG420C00_	400	420	6900	635			
KMG500C00_	500	500	7900	645	60.00	32.00	16.00
KMG600C00_	600	600	9000	750			

Table 4: Industrial 600 Volt Models in UL Type 1 Enclosures

Model Number	Nominal Horsepower	Current Rating (Amps)	Weight (lbs.)	Height (in.)	Width (in.)	Depth (in.)
KMG8C01_	5	8	115	31.38 Wall Mounted	17.50	12.14
KMG10C01_	7.5	10	115			
KMG12C01_	10	12	120			
KMG20C01_	15	20	135			
KMG25C01_	20	25	140			
KMG28C01_	25	28	145			
KMG35C01_	30	35	155			
KMG45C01_	40	45	175			
KMG55C01_	50	55	260	56.00 Wall Mounted	17.52	16.40
KMG65C01_	60	65	265			
KMG80C01_	75	80	265			
KMG110C01_	100	110	290			
KMG130C01_	125	130	295			
KMG160C01_	150	160	340			
KMG200C01_	200	200	770	76.50 Free Standing	36.00	24.00
KMG250C01_	250	250	775			
KMG305C01_	300	305	790			
KMG362C01_	350	362	975			
KMG420C01_	400	420	975			
KMG500C01_	500	500	1015			
KMG600C01_	600	600	1015			

Table 5: General Purpose 480 Volt Models in NEMA 1 Enclosures

Model Number	Nominal Horsepower	Current Rating (Amps)	Weight (lbs.)	Height (in.)	Width (in.)	Depth (in.)
KMG55AG010000	40	55	209	36.50	18.67	29.50
KMG65AG010000	50	65	215			
KMG80AG010000	60	80	235			
KMG110AG010000	75	110	220			
KMG130AG010000	100	130	225			
KMG160AG010000	125	160	250			
KMG200AG010000	150	200	260			
KMG250AG010000	200	250	595	64.00	24.17	42.00
KMG305AG010000	250	305	625			
KMG362AG010000	300	362	630			
KMG420AG010000	350	420	635			
KMG480AG010000	400	480	635			
KMG600AG010000	500	600	755			

Table 6: General Purpose 480 Volt Models in NEMA 3R Enclosures

Model Number	Nominal Horsepower	Current Rating (Amps)	Weight (lbs.)	Height (in.)	Width (in.)	Depth (in.)
KMG55AG3R0000	40	55	209	36.50	18.67	29.50
KMG65AG3R0000	50	65	215			
KMG80AG3R0000	60	80	235			
KMG110AG3R0000	75	110	220			
KMG130AG3R0000	100	130	225			
KMG160AG3R0000	125	160	250			
KMG200AG3R0000	150	200	260			
KMG250AG3R0000	200	250	595	64.00	24.17	42.00
KMG305AG3R0000	250	305	625			
KMG362AG3R0000	300	362	630			
KMG420AG3R0000	350	420	635			
KMG480AG3R0000	400	480	635			
KMG600AG3R0000	500	600	755			

Table 7: General Purpose 600 Volt Models in NEMA 1 Enclosures

Model Number	Nominal Horsepower	Current Rating (Amps)	Weight (lbs.)	Height (in.)	Width (in.)	Depth (in.)
KMG45CG010000	40	45	209	36.50	18.67	29.50
KMG55CG010000	50	55	235			
KMG65CG010000	60	65	235			
KMG80CG010000	75	80	266			
KMG110CG010000	100	110	275			
KMG130CG010000	125	130	280			
KMG160CG010000	150	160	290			
KMG200CG010000	200	200	570	64.00	24.17	42.00
KMG250CG010000	250	250	615			
KMG305CG010000	300	305	620			
KMG362CG010000	350	362	650			
KMG420CG010000	400	420	675			
KMG500CG010000	500	500	810			
KMG600CG010000	600	600	835			

Table 8: General Purpose 600 Volt Models in NEMA 3R Enclosures

Model Number	Nominal Horsepower	Current Rating (Amps)	Weight (lbs.)	Height (in.)	Width (in.)	Depth (in.)
KMG45CG3R0000	40	45	209	36.50	18.67	29.50
KMG55CG3R0000	50	55	235			
KMG65CG3R0000	60	65	235			
KMG80CG3R0000	75	80	266			
KMG110CG3R0000	100	110	275			
KMG130CG3R0000	125	130	280			
KMG160CG3R0000	150	160	290			
KMG200CG3R0000	200	200	570	64.00	24.17	42.00
KMG250CG3R0000	250	250	615			
KMG305CG3R0000	300	305	620			
KMG362CG3R0000	350	362	650			
KMG420CG3R0000	400	420	675			
KMG500CG3R0000	500	500	810			
KMG600CG3R0000	600	600	835			

Product Technical Specifications

Table 9 and Table 10 list the major technical specifications for the MotorGuard product line.

Table 9: MotorGuard Technical Specifications – Industrial





Current Ratings	Continuous current: 8 to 750 amps. See Rating and Dimension tables Overload current: 150% for 1 minute out of every 60 minutes
VFD Output Voltage	460/480 and 575/600 V, 3 ph, at fundamental base frequency
VFD Output Frequency	0 to 80 Hz
VFD Carrier Frequency	2 kHz and 16 kHz; ideally a minimum of 4 kHz
Control Power Input	For fan operation.
Filter Performance	Maximum peak voltage of output waveform – 480 V models: 815 V – 600 V models: 1,018 V Maximum dV/dt of output waveform – 480 V models: 5 V/μs – 600 V models: 6 V/μs
Maximum Elevation	Up to 2,000m (6,600ft) without derating. Consult factory for higher elevations.
Operating Temperature	-30°C (-22°F) to 50°C (122°F) open panel -30°C (-22°F) to 40°C (104°F) enclosed
Storage Temperature	-40°C (-40°F) to 50°C (122°F)
Maximum Humidity	95%, non-condensing.
Enclosure Options	Open panel for mounting in an enclosure furnished by others UL Type 1 enclosure
Enclosure Finish	Free standing enclosures: ANSI 61 gray Wall mount enclosures: White Matte (beige) Munsel 5.8Y7.83/1
Agency Approvals or Certifications	 UL and cUL Listed to UL508A and CSA-C22.2 No. 14
Insertion Impedance	Approximately 6.5% at 60 Hz & full load current
Fusing and Protection:	Unit has internal fuse protection and a performance monitoring circuit.
Capacitors	Oil filled high endurance design (no PCBs)

Table 10: MotorGuard Technical Specifications – General Purpose

Current Ratings	Continuous current: 55 to 600 amps. See Rating and Dimension tables Overload current: 150% for 1 minute out of every 60 minutes
VFD Output Voltage	460/480 and 575/600 V, 3 ph, at fundamental base frequency
VFD Output Frequency	0 to 80 Hz
VFD Carrier Frequency	2 kHz and 16 kHz; ideally a minimum of 4 kHz
Control Power Input	For fan operation.
Filter Performance	Maximum peak voltage of output waveform – 480 V models: 815 V – 600 V models: 1,018 V Maximum dV/dt of output waveform – 480 V models: 5 V/μs – 600 V models: 6 V/μs
Maximum Elevation	Up to 2,000m (6,600ft) without derating. Consult factory for higher elevations.
Operating Temperature	-30°C (-22°F) to 40°C (104°F) enclosed
Storage Temperature	-40°C (-40°F) to 50°C (122°F)
Maximum Humidity	95%, non-condensing.
Enclosure Options	General Purpose NEMA 1 General Purpose NEMA 3R
Insertion Impedance	Approximately 6.5% at 60 Hz & full load current
Capacitors	Oil filled high endurance design (no PCBs)

3.0 Installation Guidelines

<p>Warning</p> 	<p>Be sure to read, understand, and follow all safety instructions provided in this manual prior to beginning work.</p>
<p>Warning</p> 	<p>Dangerous Voltage is used in the operation of the MotorShield™. Only qualified electricians should carry out all electrical installation and maintenance work on the MotorShield™.</p>
<p>Warning</p> 	<p>All wiring must be performed in accordance with the National Electrical Code (NEC) and/or any other codes that apply to the installation site.</p>

Pre-installation Planning

Verify the Application

Make sure that the MotorGuard is correct for the application. The voltage and current ratings of the MotorGuard must match the output voltage and current ratings of the connected variable frequency drive as it is configured for use with the connected motor.

Select a Suitable Location

Locating the MotorGuard in a suitable environment will help ensure proper performance and a normal operating life.

<p>Warning</p> 	<p>Unless specifically labeled as approved for such use, this equipment is not suitable for use in an explosive atmosphere or in a "Hazardous (Classified) Location" as defined in article 500 of the National Electrical Code.</p>
---	---

The unit must be installed in an area where it will not be exposed to:

- Corrosive liquids or gasses
- Explosive or combustible gases or dust
- Excessive airborne dirt and dust
- Excessive vibration

In addition to the above, products that are not in a 3R enclosure should not be exposed to:

- Direct sunlight
- Rain or excessive dripping liquids

Mounting Area

Select a mounting area that will allow sufficient cooling air to flow through the unit. Adequate space should be provided to allow access for maintenance.

If you are mounting an open panel unit in your own enclosure, you must provide an enclosure that is adequately sized and ventilated sufficiently to prevent overheating. The rating and dimension tables for open panel units list the watts of heat loss that is dissipated by the MotorGuard. The maximum temperature of the air around the MotorGuard's capacitors and PQconnect should not exceed 50 °C (122 °F).

Power Wiring Considerations

The conduit and wiring from the output of the variable frequency drive to the motor must be routed to the MotorGuard and then to the motor. When selecting a mounting location for the MotorGuard, plan for the routing of the power wiring.

Control Wiring Considerations

The MotorGuard requires 120 VAC single-phase power for the PQconnect and cooling fans. The control power source must be ensured to be energized whenever the variable frequency drive is operating. A control power transformer is provided in the MotorGuard to allow control power to be obtained from the three-phase source that provides input power to the VFD. Fuses are provided on the control transformer, but the wires connecting control power to the MotorGuard will need to be appropriately protected at the power source.

Refer to the drawings furnished with your MotorGuard to determine the control power VA required.

Thermal Switch

A normally closed thermal switch is included on the sine wave reactor. The thermal switch opens if the filter reactor overheats. Connect this switch to the VFD external fault input to monitor the integrity of the filter. This is on the filter as a method of protecting the components in the situation where the temperature begins to get above the acceptable levels of operation.

Optional Features

Additional wiring requirements may apply to MotorGuard units that are equipped with certain optional features such as a space heater or 120 VAC control power supplied directly rather than through a control power transformer. For instructions covering these additional requirements, refer to drawings and/or other supplemental information furnished with the unit.

Mounting

The MotorGuard must be mounted vertically on a smooth, solid surface, free from heat, dampness, and condensation. Provide 3" of clearance along the sides of an enclosed filter.

Wiring

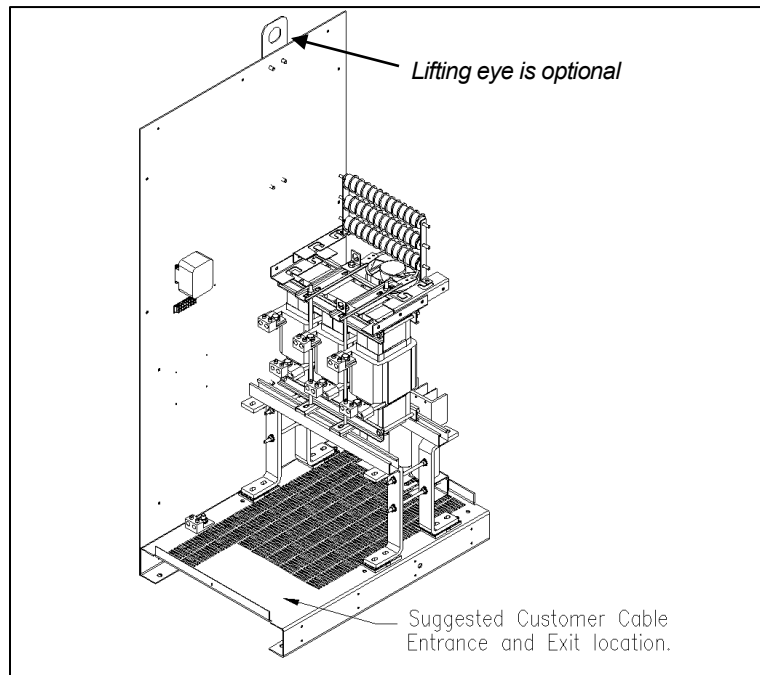
Cable Entry Locations**Figure 4: Cable Entry Location for General Purpose units***Field Wiring Connection Terminals*

Compression type terminals may be provided for all field wiring connections. The control circuit terminals will accommodate 18 AWG to 10 AWG wire and should be tightened to 18 in.-lbs. torque. The wire size capacity ranges and tightening torque for the grounding and power terminals are listed in the following tables.

Table 11: Motor Power Terminal Wire Size Capacity Range and Tightening Torque (Cu or Al) - Industrial

KMG IND Model Numbers	Ground Lug		Input and Output Motor Power	
	Wire Size	Torque (in.-lb.)	Wire Size	Torque (in.-lb.)
KMG8A to KMG55A KMG8C to KMG45C	14 - 1/0 AWG	200	22 - 16 AWG 14 - 6 AWG 4 - 2 AWG and 1 AWG (7 & 19 strand only)	25 30 35
KMG65A to KMG130A KMG55C to KMG130C	6 - 2/0 AWG	120	6 - 2/0 AWG	120
KMG160A to KMG200A KMG160C to KMG200C	6 AWG - 250 MCM	275	6 AWG - 250 MCM	275
KMG250A to KMG305A KMG250C to KMG305C	4 AWG - 600 MCM or (2) 1/0 AWG - 250 MCM	500	4 AWG - 600 MCM or (2) 1/0 AWG - 250 MCM	500
KMG362A KMG362C to KMG420C	(2) 4 AWG - 350 MCM	275	(2) 4 AWG - 350 MCM	275
KMG420A to KMG600A KMG500C to KMG600C	(2) 2 AWG - 600 MCM	500	(2) 2 AWG - 600 MCM	500
KMG750A	(3) 2 AWG - 600 MCM	375	(3) 2 AWG - 600 MCM	375

Table 12: Motor Power Terminal Wire Size Capacity Range and Tightening Torque (Cu or Al) – General Purpose

KMG GP Model Numbers	Ground Lug		Input and Output Motor Power	
	Wire Size	Torque (in.-lb.)	Wire Size	Torque (in.-lb.)
KMG55A KMG45C	14 - 1/0 AWG	200	22 - 16 AWG 14 - 6 AWG 4 - 2 AWG and 1 AWG (7 & 19 strand only)	25 30 35
KMG65A to KMG130A KMG55C to KMG130C	6 - 2/0 AWG	120	6 - 2/0 AWG	120
KMG160A to KMG200A KMG160C to KMG200C	6 AWG - 250 MCM	275	6 AWG - 250 MCM	275
KMG250A to KMG305A KMG250C to KMG305C	4 AWG - 600 MCM or (2) 1/0 AWG - 250 MCM	500	4 AWG - 600 MCM or (2) 1/0 AWG - 250 MCM	500
KMG362A KMG362C to KMG420C	(2) 4 AWG - 350 MCM	275	(2) 4 AWG - 350 MCM	275
KMG420A to KMG600A KMG500C to KMG600C	(2) 2 AWG - 600 MCM	500	(2) 2 AWG - 600 MCM	500

Connection Diagram

Figure 5 shows the typical wiring connections between the MotorGuard and the VFD and motor. Note that separate conduits may be required for the control power and fault contact wiring. Refer to the instructions for the VFD or other equipment to which the fault contact is connected.

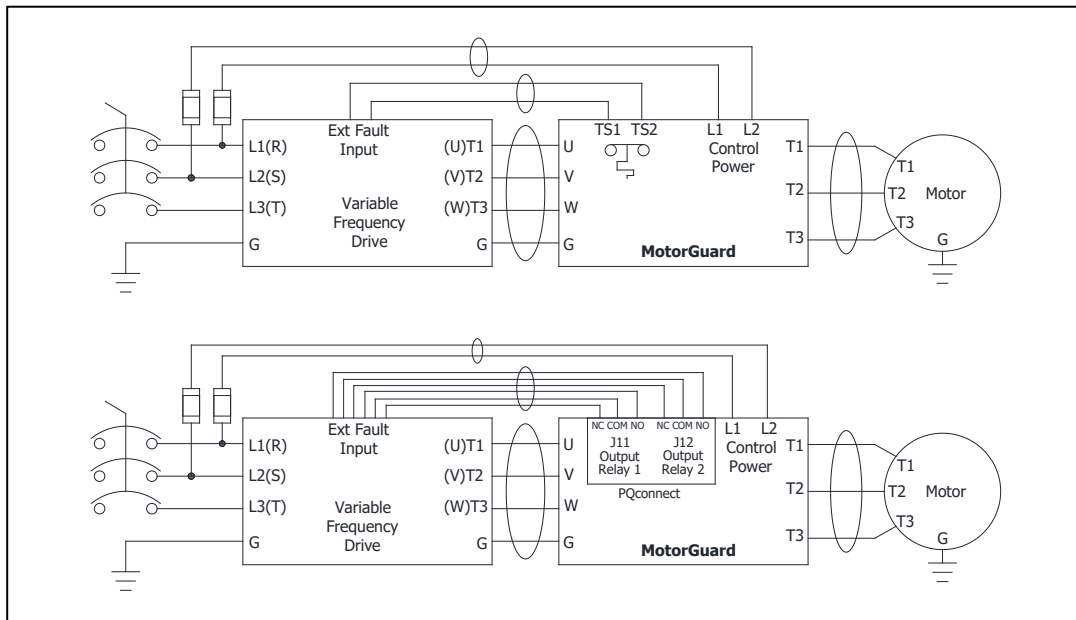



Figure 5: Typical Connection Diagram

Grounding

The MotorGuard panel equipment grounding lug must be connected to the ground of the premises wiring system. The equipment grounding connection must conform to the requirements of the National Electric Code (NEC) and/or any other codes that apply to the installation site. The ground connection must be made using a wire conductor. Metallic conduit is not a suitable grounding conductor. The integrity of all ground connections should be periodically checked.

Power Wiring

Connect the output of the VFD, terminals T1(U), T2(V), & T3(W), to the input of the MotorGuard, terminals U, V, & W. Connect the motor to the output of the MotorGuard, terminals T1, T2, & T3.

<p>Caution</p> 	<p>Use wire that is appropriate for the voltage and current rating of the motor.</p> <p>For units rated less than 100 amps, use copper or aluminum wire with an insulation temperature rating of 60 °C or higher.</p> <p>For units rated 100 amps or more, use copper or aluminum wire with an insulation temperature rating of 75 °C or higher.</p> <p>The wire size and the voltage ratings must conform to the requirements of the National Electrical Code and/or other applicable electrical codes.</p> <p>Be sure to also follow the motor wiring instructions provided in the instruction manual for the VFD.</p>
---	--

Control Wiring

Connect control power to the MotorGuard. Be sure to provide fuses or other appropriate protection for the control power wiring. Make sure that the voltage and VA capacity of the control

power source matches the MotorGuard's control power input ratings. Refer to the drawings shipped with the unit.

Do not connect fan circuit to the output of VFD, separate line voltage needs to be wired to the filter. Damage to the filter will occur if fans are left unpowered or connected to VFD output.

For filters with PQconnect, connect the MotorGuard PQconnect fault output relay contacts to the appropriate fault monitoring circuit. It may be connected to the VFD or to some supervisory control or alarm annunciation equipment.

Thermal Switch

This option includes an over-temperature switch installed on the sine wave reactor. On the reactor, over-temperature switches are wired to a terminal block separate from the power terminals. The over-temperature switch opens if unpredicted heating occurs. An interlocking circuit should be used with the over-temperature switch to turn off the VFD to prevent filter damage in the event of filter overheating. The over-temperature switch contact is rated 6 amps at 120 VAC. The over-temperature switches are normally closed, open on temperature rise and typically have the following trip points:

- On a Class R 220°C insulation reactor, the switch opens on rise above 200°C
- On a Class H 180°C insulation reactor, the switch opens on rise above 160°C

Wire the over-temperature switches according to the reactor schematic using T1 and T2 locations on the over-temperature switch terminal block.

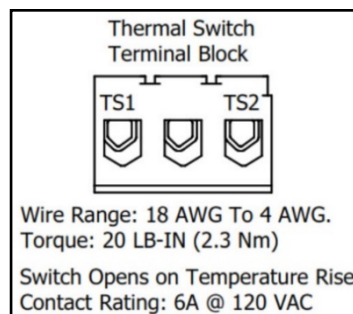

Figure 6: Terminal Block

If the KMG MotorGuard is ordered with the PQconnect, the thermal switch feedback will be wired to the PQconnect board, and the PQconnect will indicate whether there is an over-temperature problem. The PQconnect fault relay (J10 header) can be used to be alerted when there is an Over-temp issue as an additional measure. For further detail please refer to the pin out references in the PCB connections section of this manual.

Fuses

The table below lists the specifications for the LC power circuit fuses in the MotorGuard.

Table 13: RC Power Circuit Fuses for Industrial Model

480 V Models			600 V Models		
MotorGuard Rating (Amps)	Power Circuit Fuse Rating		MotorGuard Rating (Amps)	Power Circuit Fuse Rating	
	Amps	Type		Amps	Type
8	2	Class CC Bussmann type KLD-R or equivalent	8	2	Class CC Bussmann type KLD-R or equivalent
12	2.5		10	2	
16	4		12	2.5	
23	6		20	5	
30	8		25	6	
35	9		28	7	
45	12		35	9	
55	15		45	12	
65	20		55	15	
80	20		65	20	
110	30	Class T Bussmann type JJS or equivalent	80	25	Class T Bussmann type JJS or equivalent
130	35		110	30	
160	40		130	35	
200	50		160	40	
250	70		200	50	
305	80		250	70	
362	90		305	80	
420	110		362	90	
480	125		420	110	
600	150		500	125	
750	200	600	150		

Control Circuit Fuses

Refer to the drawings furnished with your MotorGuard for control circuit fuse specifications.

Installation Checklist

The following are the key points to be followed for a successful installation. These points are explained in detail in the following sections of this manual.

- Make sure that the installation location will not be exposed to corrosive or combustible airborne contaminants, excessive dirt, or liquids.
- Select a mounting area that will allow adequate cooling air and maintenance access.
- Make sure that all wiring conforms to the requirements of the National Electric Code (NEC) and/or other applicable electrical codes.
- Connect the MotorGuard equipment grounding lug to the system ground of the premises wiring system. Use a properly sized grounding conductor.
- Wire the output power terminals of the VFD, T1(U), T2(V), & T3(W) to the input terminals of the MotorGuard, U, V, & W.
- Wire the output power terminals, of the MotorGuard, T1, T2, & T3 to the motor.
- Connect control power to the MotorGuard as described in the section Control Wiring .

- For PQconnect option: Connect the MotorGuard fault relay contact to the appropriate fault monitoring circuit.
- Connect product thermal switches to VFD external fault input relay. This will monitor filter component temperatures, and shut down VFD and troubleshoot issues should cooling power be lost, cooling equipment fails, or VFD output get outside of the filter design limitations.
- Make sure that the VFD is set for operating modes and ranges that are compatible with the MotorGuard sine wave filter.
- Check everything thoroughly before operating the equipment.

4.0 Operation



Since the MotorGuard is a passive filter, it is always operating whenever the variable frequency drive is operating. Whenever the VFD is operating, control power should be applied to the MotorGuard so that the MotorGuard's cooling fan will operate and prevent it from overheating. Control power is also required for the PQconnect.

Variable Frequency Drive Settings

Make sure that the variable frequency drive is set for operation modes and ranges that are compatible with the MotorGuard:

- Maximum output frequency: 80 Hz
- PWM switching frequency between 2 kHz and 16 kHz; ideally a minimum of 4 kHz. Since the MotorGuard removes most of the harmonic content from the output waveform, quiet motor operation should be achieved with a switching frequency setting within this range.
- Mode of operation: "scalar" or "V/Hz" without DC braking unless the drive applications has been confirmed by TCI Technical Support
- Consult VFD manual for other drive specific recommendations for use with sine wave filters, specific instructions may include but are not limited to: disabling any variable PWM switching frequency options such as features to reduce motor noise or control temperature and setting drive to continuous 3-phase modulation.

Start Up (Commissioning)

<p>Caution</p> 	Thoroughly check the installation before applying power and operating the equipment for the first time.
<p>Caution</p> 	Never Operate the MotorGuard without a load connected to its output terminals.

Before Applying Power for the First Time

Inspect the installation to make sure that all equipment has been completely and correctly installed in accordance with the **Installation Guidelines** section of this manual.

Before Operating the VFD for the First Time

Make sure that the variable frequency drive is set for operation modes and ranges that are compatible with the MotorGuard as described above.

Drawings

Typical MotorGuard drawings are provided on the transcoil website. Please visit <https://transcoil.com/products/motorguard-sinewave-filter/motorguard-industrial-drawings/>

These drawings provide general information describing your MotorGuard filter. More specific information is provided by the drawings shipped with the unit. Be sure to carefully review the information provided by these drawings. This information takes precedence over the information provided in this manual

5.0 PQconnect

Product Description

The PQconnect is an integrated controls option for TCI's industry sine wave filter used for filtering the output of variable frequency motor drives (VFDs). In the sine wave filter, the PQconnect provides unit status detection, metering, voltage waveform and power quality data. The PQconnect data is made available via basic Modbus RTU over RS485 serial connection. The PQconnect is UL listed and intended for commercial and industrial applications.

Modbus RTU

The PQconnect Modbus RTU network communication interface transmits and receives command and status data from the PQconnect Modbus master over a RS-485 serial link. Modbus RTU is a simple serial communications protocol originally developed by Modicon for use with Programmable Logic Controllers (PLCs) in control of industrial devices. Modbus RTU is commonly supported by most PLCs and is an open, royalty-free communications standard.

The PQconnect implements a Modbus RTU Master/Slave device, which supports two-wire RS-485 signal levels. The PQconnect communication port used for the Modbus RTU interface is connected directly to the PCB. The communication port is located on the side of the PQconnect board.

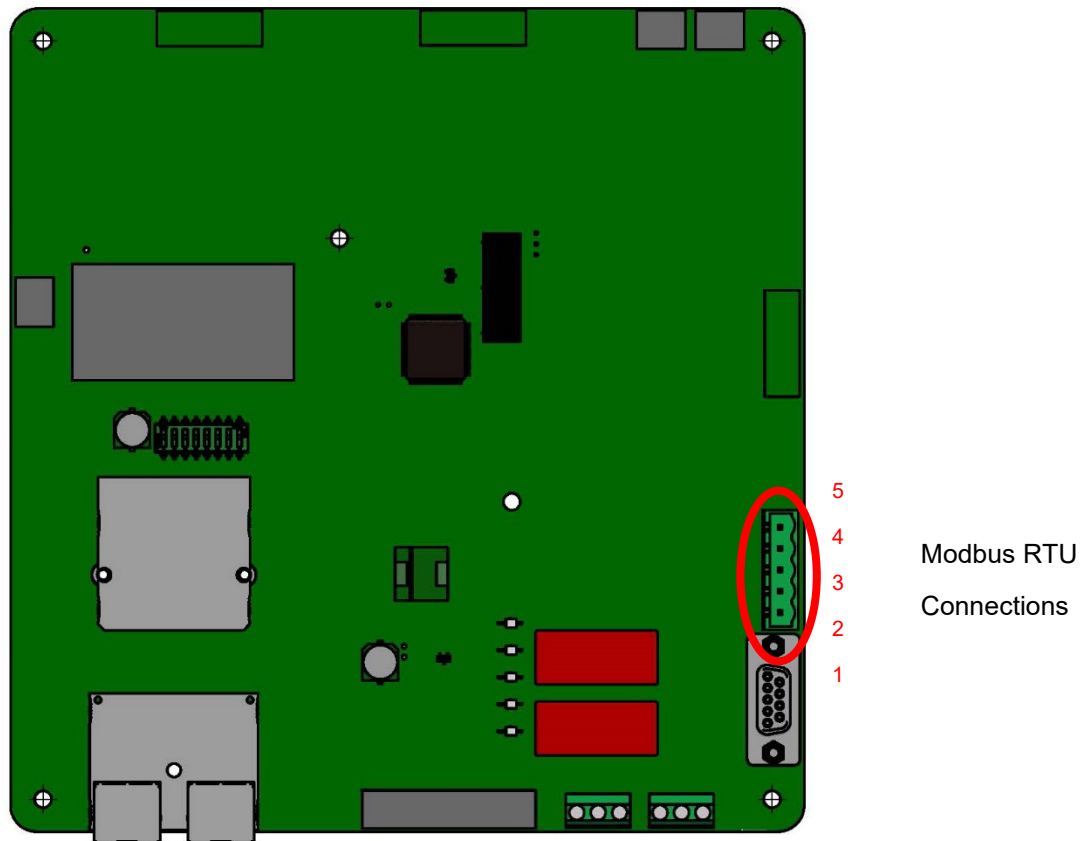

Figure 7: PQconnect Modbus RTU Connection

PQvision PC application Screen Elements

This section focuses on the operation of the PQvision application. The PC application contains several screens that allow the user to monitor the status of the KMG Sine Wave filter. Additionally, the PQvision application can be used for basic setup of the KMG Sine Wave filter.

Enter password **08252014** to enable tech access.

Please ensure the latest version of PQvision is downloaded to your PC. The software is available on the TCI KMG page located here:

<https://transcoil.com/products/motorguard-sinewave-filter/>

A standard RS485 to USB converter can be used with your sine wave filter with PQconnect. To run the PQvision software the converter will need to be connected to terminal J5 on the PQconnect PCB with pin orientation as described in Table 14, the USB connector will need to be run to laptop or PC.

PQvision PC Home Screen Elements

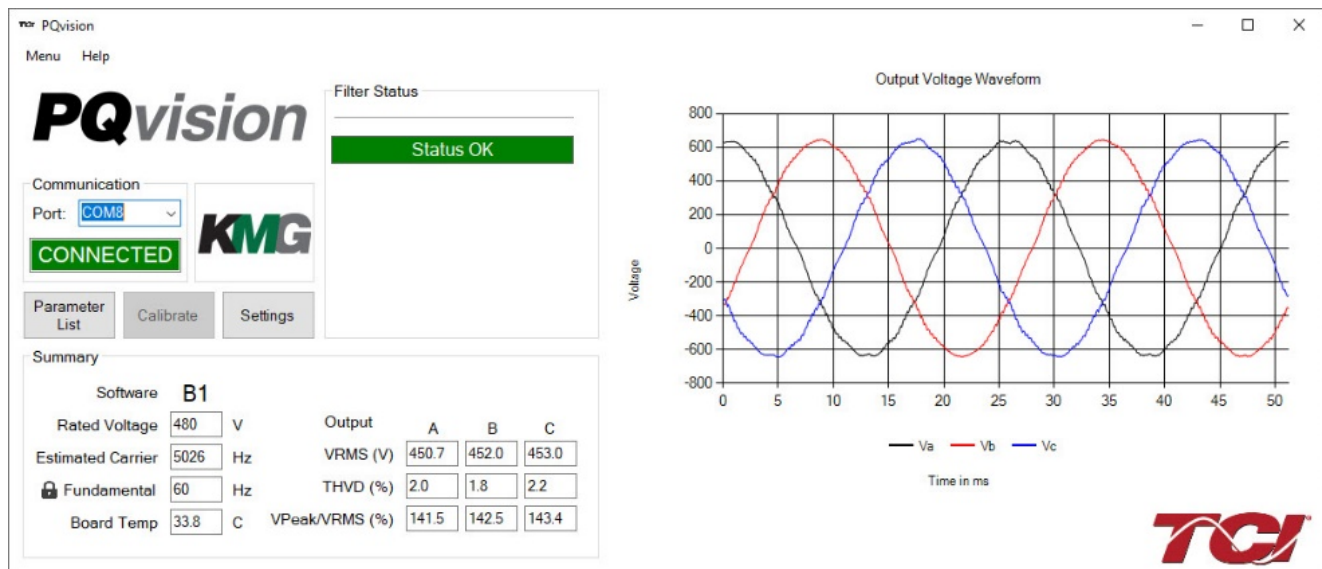

Figure 8: PQvision Desktop Application

The tables and figures below describe navigation of the PQvision Application.

Table 14: PQvision PC Navigation

Designators	Name	Description
1	Filter Status	Will determine the status of the filter and output of the filter
2	Output Voltage Waveform	The PQconnect PC application supports capture and display of real time of the filters Output Voltage. Phase A – Black Phase B – Red Phase C – Blue
3	Communication	Communication Status and Communication Port To determine the COM port, go to Device Manager Ports (COM & LPT) and finding “USB Serial Port”

		Note: If Modbus settings differ from the default values above; Set and save desired Modbus settings, then select Reset PQconnect from the drop-down Menu.
4	Summary Data	Displays PQconnect Software revision
		Displays the estimated carrier frequency of the VFD in Hz
		Displays the fundamental frequency of the filter output voltage in Hz
		Displays the board temperature in degrees Celsius
		Displays line to line output voltage of the filter in Vrms
		(THVD) Displays the Total Harmonic Voltage Distortion of the output of the filter as a percentage
		Displays percentage of Output Peak voltage to Output RMS voltage.

PQvision PC Settings Screen Elements

To access the settings page as seen in Figure 8, under the Menu toolbar select Tech Access and Enter password **08252014** to enable the settings configurations. In the PQvision settings a user can set their desired Modbus settings, however, this will require the PQconnect reset command. The settings screen can also be used to enable and disable alert conditions that activate the output relays and Modbus registers. The tables below describe the different settings menus.

PQconnect Reset command: if changing the Modbus settings, the user will be required to reset the PCB after saving settings. This can be easily done through the menu by clicking menu and Reset PQconnect. The reset command will only work if the PCB is communicating to the desktop application or Modbus network. Note: resetting the board will de-energize the relay outputs if the relay state is closed.

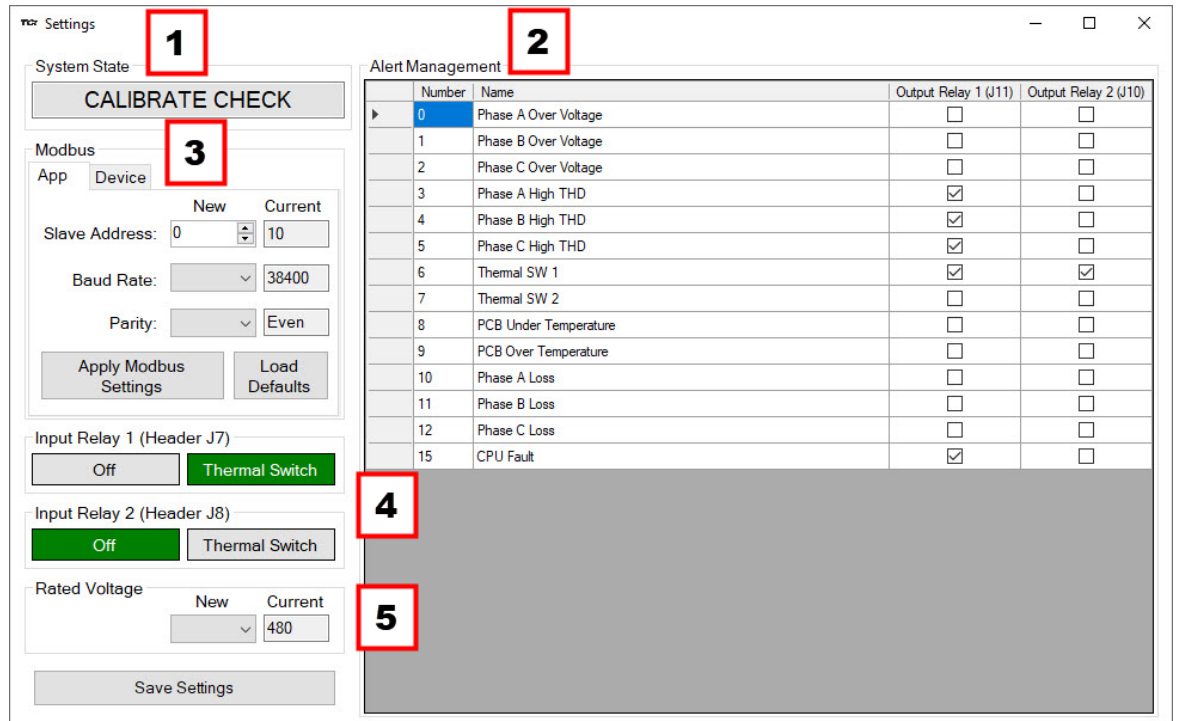

Figure 9: PQvision Settings Menu

Table 15: PQvision Settings Menu

Designators	Name	Description
1	System State	<p>Determines if the unit's PCB is ready to run</p> <p>"Run" – PCB is calibrated and ready</p> <p>If the system state is labeled as "Calibrate check" the user must perform the calibration process. Follow calibration steps in the debug section</p>
2	Alert Management	<p>This section can be used to enable and disable the status detections conditions that drive the output relays. Upon power up the relays energize, closing the normally open contacts. This is the nominal status OK state. The output relays stay in this state until one of the configured alerts is detected or the board becomes unpowered.</p> <p>After selecting desired relay outputs select save settings.</p>
3	Modbus	<p>Allows the user to change Modbus settings of the App and device.</p> <p>When changing Modbus settings, the user will start with selecting a new slave address/Baud rate/ and parity of the Device. After selecting desired Modbus settings of the device, the user will select apply Modbus settings and save settings.</p> <p>Afterwards the user will need to go to Menu and Reset PQconnect. This will soft reboot the board.</p> <p>Note: Changing Modbus settings of the device can only be done through tech access</p> <p>If the user would still like to use the PQvision application with the updated Modbus settings, they would need to navigate to the settings menu and apply the new Modbus settings for the application.</p>
4	Relay Inputs	<p>By default, Input Relay 1 will be set to thermal switch and Input Relay 2 is off. Relay 1 is intended to be used with the normally closed thermal switch available on the filter reactor.</p> <p>Note: Input Relay 1 is connected to J7 of the PCB and Input Relay 2 is connected to J8.</p>
5	Rated Voltage	<p>Allows the user to change the filter rated voltage.</p> <p>Note: The user should only select the voltage the filter is rated for. Range 240V to 600V</p>

In the PQvision settings a user can set their desired Modbus settings, however this will require the PQconnect reset command. The settings screen can also be used to enable and disable alert conditions that activate the output relays and Modbus registers.

PQconnect Reset command: if changing the Modbus settings, the user will be required to reset the PCB after saving settings. This can be easily done through the menu by clicking menu and Reset PQconnect. The reset command will only work if the PCB is communicating to the desktop application or Modbus network. Note: resetting the board will de-energize the relay outputs if the relay state is closed.

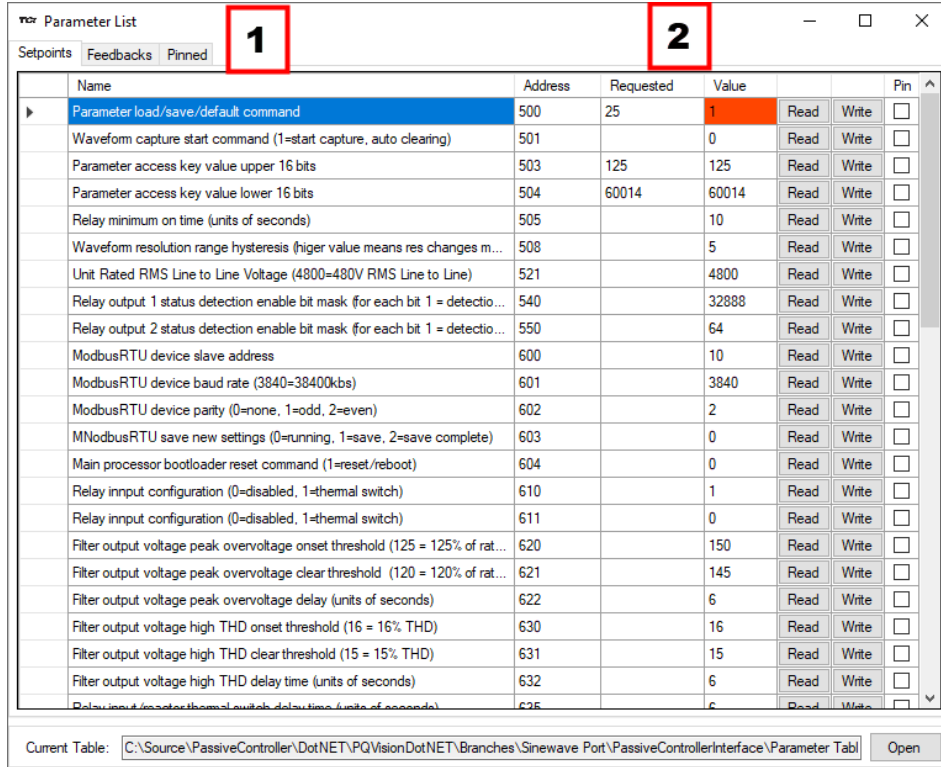

Figure 10: PQvision Parameter List Menu

Table 16: PQvision Parameter List Menu

Designators	Name	Description
1	Toolbar Menu	<p>The setpoints toolbar will allow the user to adjust parameters to their desired settings.</p> <p>Feedbacks will allow the user to view the present values of the filter.</p> <p>The Pinned tab will have any pinned parameters the user selects. To pin parameters the user will select the pins box for each desired parameter.</p> <p>View parameter tables to determine what each value means.</p>
2	Address/ Requested/ Value/ Read/ Write	<p>Address is the spare ID for each parameter</p> <p>Requested – If the user would like to adjust any values that differ from the present value they will type in the new value in the box.</p> <p>Value is the present value the parameter</p> <p>Read/Write buttons: Pressing the Read button will display the current value of the parameter. Pressing write will allow the user to overwrite the present value.</p>

PQvision PC Status Detection History Elements

Index	Timestamp (pc.sec.msec)	Status	VTHDA (%)	VTHDB (%)	VTHDC (%)	VOutAvg (%Rated)	Fund (Hz)	Carrier (Hz)
0	005:000000503:000	0x0000 - STATUS_OK	0	0	0	0	0	0
1	005:000000475:270	0x0038 - HIGH_THD_A - HIGH_THD_B - HIGH_THD_C	51	51	51	105	60	5000
2	-	-	-	-	-	-	-	-
3	-	-	-	-	-	-	-	-
4	-	-	-	-	-	-	-	-
5	-	-	-	-	-	-	-	-
6	-	-	-	-	-	-	-	-
7	-	-	-	-	-	-	-	-
8	-	-	-	-	-	-	-	-
9	-	-	-	-	-	-	-	-
10	-	-	-	-	-	-	-	-
11	-	-	-	-	-	-	-	-
12	-	-	-	-	-	-	-	-
13	-	-	-	-	-	-	-	-
14	-	-	-	-	-	-	-	-
15	-	-	-	-	-	-	-	-
16	-	-	-	-	-	-	-	-
17	-	-	-	-	-	-	-	-
18	-	-	-	-	-	-	-	-
19	-	-	-	-	-	-	-	-
20	-	-	-	-	-	-	-	-
21	-	-	-	-	-	-	-	-
22	-	-	-	-	-	-	-	-

Figure 11: Status Detection History

Table 17: PQvision Status Detection History Menu

Designators	Name	Description
1	Index	Number of status conditions that occurred in the filter Note: when reaching the 99 index any new status conditions will start to overwrite existing index's starting with index 0. The newest entry in the status history is always shown at the top of the history list. The oldest entry will be at the bottom of the list.
2	Timestamp (PC: Sec: Msec)	The timestamp will indicate when a status condition was detected. The first 3 numbers represent the number of times the PCB power cycled when the event occurred. The middle 10 and last 3 digits represent the time in seconds:milliseconds format since the last power on of the PQconnect board since the status condition was detected
3	Status	Status will indicate the status detection that occurred. The status bit mask formatted as a hex value volowed by a list of status conditions will be shown.
4	Values	The status history will also record diagnostic values when the status was detection Values recorded: VTHD of A-B phase, VTHD of B-C Phase, VTHD of C-A, Fundamental frequency in Hz, Carrier frequency in Hz and the average filter output line to line RMS voltage scaled in percent rated Volts. For example for a 480 V sinewave filter a value of 100% would indicate average filter output voltage was 480VRMSLL.

Modbus RTU Connections

The hardware pinout for the J5 communication header and default settings is shown below.

Table 18: Modbus Connector Pin Definitions

J5 Header Pinout	Signal Name	Signal Type
1	No connect	-
2	D+	RS-485 B (non-inverting)
3	GND	RS-485 SC/G
4	D-	RS-485 A (inverting)
5	No connect	-

The default protocol settings for the RS-485 Modbus RTU interface are shown below.

Table 19: Modbus RTU Protocol Settings

Parameter	Value	Units
Baud Rate	38400	Bd
Data Bits	8	Bits
Stop Bits	1	Bits
Parity	Even	-
Slave ID	10	-

Table 20: Configuration Switches

SW1	Configure Modbus Connection on J5 Header	1 – Enable 560Ω bias resistor on D-. 2 – Enable 120Ω termination resistor. 3 - Enable 560Ω pull-up on D+.

Modbus Input and Output Register Maps

The input and output registers from the KMG Sine Wave filter are mapped to the Modbus Analog Output Holding Registers starting at address 40000. See Table 27 through Table 29 for definitions of the input register maps and Table 21 through Table 25 for output register maps. All input and output registers are two bytes in size and formatted as 16-bit signed integers.

Table 21: Network Interface OUTPUT/ Feedback Register Map

Note: For metering data including Output Voltage, THvD, Peak Voltage to RMS voltage ratio, Fundamental Frequency, and Carrier Frequency, if data is not available, the PQconnect will report a value of 63353 (or 0xFFFF in hex format) to indicate no data is available. The no data available condition is usually triggered by the filter output voltage being below the minimum fundamental frequency tracking voltage threshold (see parameter 680.)

Parameter Name	I/O Reg Address Offset	Direction	Format and Examples	Description
USER_STATE	10	Input	0 = Initialization 9 = Save current values to flash 150 = Load values from Flash 255 = Restore Defaults to Flas	User state parameters Read only value.
DSP_SW_VER	12	Output	Two 8bit ASCII Characters Example: 0x0141 = ASCII for "A1"	Software revision code for processor. Read only value.
DSP_MODEL_NUM	13	Output	Sinewave Filter	System Model Number Read Only Value
V_LOAD_AB_RMS	50	Output	Volts RMS	Filter output RMS voltage phases A-B

			4800 = 480.0 VRMSLL	Read only value.
V_LOAD_BC_RMS	51	Output	Range: 120 to 690 VRMSLL 65535 (0xFFFF) = data not available	Filter output RMS voltage phases B-C Read only value.
V_LOAD_CA_RMS	52	Output		Filter output RMS voltage phases C-A Read only value.
V_LOAD_AB_THD	53	Output		Filter output voltage THD phases A-B Read only value.
V_LOAD_BC_THD	54	Output	% THVD 50 = 5.0% THVD 65535 (0xFFFF) = data not available	Filter output voltage THD phases B-C Read only value.
V_LOAD_CA_THD	55	Output		Filter output voltage THD phases C-A Read only value.
V_LOAD_AB_PEAK_RMS_RATIO	60	Output		Filter output peak voltage to output RMS voltage ratio A-B phase Read only value.
V_LOAD_BC_PEAK_RMS_RATIO	61	Output	% PEAK voltage /RMS voltage 1414 = 141.4% 65535 (0xFFFF) = data not available	Filter output peak voltage to output RMS voltage ratio B-C phase Read only value.
V_LOAD_CA_PEAK_RMS_RATIO	62	Output		Filter output peak voltage to output RMS voltage ratio C-A phase Read only value.
V_OUT_FUND_HZ	100	Output		Range 1 to 500 Hz 65535 (0xFFFF) = data not available
V_IN_CARRIER_HZ	101	Output	Range 1 kHz to 16 kHz 65535 (0xFFFF) = data not available	Filter input carrier frequency. Note: due to widely variable modulation schemes and controls of industry VFDs, this value may not always be accurate. This is intended as an information estimate of VFD switching frequency only. Read only value.
V_OUT_ROT	102	Output	0 = undetermined 1 = ABC Rotation 2 = ACB Rotation	Filter output phase orientation Read only value
T_PCB	103	Output	400 = 40 C°	Filter internal ambient temperature Read only value.

Table 22: Network Interface OUTPUT/ Feedback Register Map

Parameter Name	I/O Reg Address Offset	Direction	Format and Examples	Description
SYS_POWER_ON	201	Output	0 = Power on unsuccessful 1 = Power on successful	Determines if the PCB was powered on Read only value.
SYS_INIT_COMPLETE	202	Output	0 = Calibration in progress 1 = Calibration complete	Determines the PCB's initial state of calibration. Read only value.
CAP_DEGREDDATION_WARNING	205	Output	0 = No warning Non zero value = warning	Filter warning This value is a bit mask where individual bits are set to indicate a detection is active. For a description of bit positions see Table 15 Read only value.
DETECTION_STATUS	210	Output	0 = Detection clear Non zero value = Detection active	Relay output 1 and 2 status bit mask This value is a bit mask where individual bits are set to indicate a detection is active. For a description of bit positions see Table 15 Read only value.
OUTPUT_RELAY_1_ENABLE_RO	230	Output	For each bit position: 0 = Detection disabled 1 = Detection enabled	Output relay 1 status detection enable This value is a bit mask where individual bits are set/cleared to enable/disable a specific status detection. For a description of bit positions see Table 15 Read only value.
OUTPUT_RELAY_2_ENABLE_RO	240	Output	For each bit position: 0 = Detection disabled 1 = Detection enabled	Output relay 2 status detection enable This value is a bit mask where individual bits are set/cleared to enable/disable a specific status detection. For a description of bit positions see Table 15 Read only value.
TRACE_GO_DONE_RO	251	Output	0 = Data capture complete 1 = Data capture in progress	Capture waveform data Read only value
PARAM_ACCESS_LEVEL_RO	254	Output	0 = User access 1 = Tech access	Different access levels available

			2 = Factory access	Read only value.
PARAM_STATE	255	Output	0-11, 13-17 = parameter load, save, restore, reboot in progress. 12 = parameter load complete	Indicates the present state of the parameter state machine. Read only value.
SYS_STATE	256	Output	0 = Initial state 1 = Parameter load 2 = Calibration in Progress 3 = Calibration check 4 = Run Detections	Determines the current state of the PQconnect Read only value.
RATED_VOLTAGE_RO	260	Output	4800 = 480.0Vrms Range = 1200 to 6900	Filter rated voltage Read only value.
MB_SLAVE_ADDRESS_RO	300	Output	Default = 10 Range 0 to 255	Modbus slave address Read only value. To change this value, modify the corresponding register in the setpoint section below. Read only value.
MB_BAUD_RATE_RO	301	Output	960 = 9600 baud rate 3840 = 38400 baud rate (DEFAULT) 11520 = 115200 baud rate	Modbus baud rate Read only value. To change this value, modify the corresponding register in the setpoint section below. Read only value.

Table 23: Network Interface OUTPUT / Feedback Register Map

Parameter Name	I/O Reg Address Offset	Direction	Format and Examples	Description
MB_PARITY_RO	302	Output	0 = None 1 = Odd 2 = Even (DEFAULT)	Modbus Parity Read only value. To change this value, modify the corresponding register in the setpoint section below.
RELAY_INPUT_STATUS	320	Output	1 = Thermal switch opened	Relay input status. Read only value.
RELAY_INPUT_1_CONFIG_RO	321	Output	0 = Disabled 1 = Thermal Switch (DEFAULT)	Input relay 1 configuration. View PCB header J7 Read only value.
RELAY_INPUT_2_CONFIG_RO	322	Output	0 = Disabled (DEFAULT) 1 = Thermal Switch	Input relay 2 configuration. View PCB header J8 Read only value.
SYS_SERIAL_NUM_2_RO	350	Output	Parameter contains UUUU in the UUUULLLL-NN serial number format.	Unit serial number upper 16-bit value Read only value.
SYS_SERIAL_NUM_1_RO	351	Output	Parameter contains LLLL in the UUUULLLL-NN serial number format.	Unit serial number lower 16-bit value Read only value.
SYS_SERIAL_NUM_0_RO	352	Output	Parameter contains NN in the UUUULLLL-NN serial number format.	Unit serial number section - two-digit unit number. Read only value.
SYS_NULL_STAT	400	Output	0 = Calibration not active 1 = Calibration in progress	System calibration status Read only value.
SYS_NULL_TMR	401	Output	Range 0 to 3600 seconds	Calibration remaining time measured in seconds Read only value.

Table 24: Fault Codes

Bit Position	Fault Descriptions
<i>16 bit register with bit position 0 to 15</i>	
0	Overvoltage Phase A
1	Overvoltage Phase B
2	Overvoltage Phase C
3	High THVD Phase A
4	High THVD Phase B
5	High THVD Phase C
6	Reactor Thermal Switch 1
7	Reactor Thermal Switch 2
8	PCB Under Temperature
9	PCB Over Temperature
10	Phase Loss (Phase A)
11	Phase Loss (Phase B)
12	Phase Loss (Phase C)
13	Unused
14	Unused
15	CPU Error

Table 25: Network Interface INPUT/Setpoint Register Map

Parameter Name	I/O Reg Address Offset	Direction	Format and Examples	Description
USER_STATE_REQ	500	Input	0 = Initialization 9 = Save current values to flash 150 = Load values from Flash 255 = Restore Defaults to Flash	Note that defaulting the flash will clear all calibration data and require that the calibration procedure be re-run..
TRACE_GO_DONE	501	Input	0 = Capture Done 1 = Start Capture	Update trace data points for waveforms
PARAM_KEY_A	502	Input	Enter Key A	Read/write parameters under Tech Access
PARAM_KEY_B	503	Input	Enter Key B	
RELAY_MIN_ON_TIME	505	Input	Output Relay Minimum status detection active time in seconds Range 1 to 3600 seconds. Default 10 seconds	Minimum time output relay will indicate an active status detection.
TRACE_RESOLUTION_RANGE_HYST	508	Input	Fundamental period steps of 30uS, Range 0 to 500, Default 5.	Waveform time base resolution range hysteresis. The higher the number the less the waveform will adjust its time scale based on the fundamental frequency of the filter output.
RATED_VOLTAGE	521	Input	4800 = 480 Vrms Range = 120 to 690 Vrms, Default of 4800	Filter rated voltage in Volts RMS Line to Line
OUTPUT_RELAY_1_ENABLE	540	Input	For each bit position: 0 = Detection disabled 1 = Detection enabled Default = 32888 (High THVD Phase A, B, C, Thermal SW1, and CPU error enabled). To Enable desired fault detections, enter bit mask from table by converting to decimal Range: 0 to 65535	This value is a bit mask where individual bits are set to indicate a detection is active. For a description of bit positions see Table 15 Example: Enabling all fault conditions is 1111 1111 1111 1111 in binary or 65535 decimal. * Reference Fault codes
OUTPUT_RELAY_2_ENABLE	550	Input	For each bit position: 0 = Detection disabled 1 = Detection enabled Default = 64 (Thermal SW1 enabled) To Enable desired fault detections, enter bit mask from table by converting to decimal Range: 0 to 65535	This value is a bit mask where individual bits are set to indicate a detection is active. For a description of bit positions see Table 15 Example: Enabling all fault conditions is 1111 1111 1111 1111 in binary or 65535 decimal. * Reference status conditions

MB_SLAVE_ADDRESS	600	Input	DEAFULT = 10 Range 0 to 255	Modbus RTU Device Slave Address *
MB_BAUD_RATE	601	Input	11520 = 115200 baud rate DEFAULT: 3840 = 38400 baud rate 960 = 9600 baud rate	Modbus RTU Device Baud Rate*
MB_PARITY	602	Input	0 = None 1 = Odd 2 = Even (DEFAULT)	Modbus Parity*

Table 26: Network Interface INPUT Register Map

Parameter Name	I/O Reg Address Offset	Direction	Format and Examples	Description
RELAY_INPUT_1_CONFIG	610	Input	0 = Disabled DEFAULT: 1 = Thermal Switch	Input relay configuration reference J7 header*
RELAY_INPUT_2_CONFIG	611	Input	DEFAULT: 0 = Disabled 1 = Thermal Switch	Input relay configuration reference J8 header*
STATUS_OVERVOLTAGE_ONSET	620	Input	DEFAULT: = 130% Range 100 to 500	Set desired filter output voltage peak overvoltage onset threshold*
STATUS_OVERVOLTAGE_CLEAR	621	Input	DEFAULT: = 125% Range 100 to 500	Set desired filter output voltage peak overvoltage clear threshold*
STATUS_OVERVOLTAGE_DELAY	622	Input	DEFAULT: = 6 seconds. Range 1 to 3600 seconds	Status detection delay time in seconds. Set desired filter output voltage high THD delay threshold*
STATUS_HIGH_THD_ONSET	630	Input	DEFAULT: = 16 = 16% Range 1 to 100	Set desired filter output voltage high THD onset threshold*
STATUS_HIGH_THD_CLEAR	631	Input	DEFAULT: = 15 = 15% Range 1 to 100	Set desired filter output voltage peak overvoltage clear threshold*
STATUS_HIGH_THD_DELAY	632	Input	DEFAULT: = 6 seconds. Range 1 to 3600 seconds	Status detection delay time in seconds. Set desired filter output voltage peak overvoltage delay threshold*
STATUS_REACTOR_SWITCH_DELAY	635	Input	DEFAULT: = 6 seconds. Range 1 to 3600 seconds	Status detection delay time in seconds. Reactor thermal switch time delay*
STATUS_T_AMBIENT_UT_ONSET	640	Input	DEFAULT: = -400 = -40C Range -50C to 0C	Status detection measure in degrees Celsius PCB under temperature onset threshold*
STATUS_T_AMBIENT_UT_CLEAR	641	Input	DEFAULT: = -350 = -35C	Status detection measure in degrees Celsius

			Range -50C to 0C	PCB under temperature clear threshold*
STATUS_T_AMBIENT_UT_DELAY	642	Input	DEFAULT: = 6 seconds. Range 1 to 3600 seconds	Status detection delay time in seconds. PCB under temperature delay threshold*
STATUS_T_AMBIENT_OT_ONSET	645	Input	DEFAULT: = 750 = 75C Range 10C to 85C	Status detection measure in degrees Celsius. PCB over temperature onset threshold*
STATUS_T_AMBIENT_OT_CLEAR	646	Input	DEFAULT: = 700 = 70C Range 10C to 80C	PCB over temperature clear threshold*
STATUS_T_AMBIENT_OT_DELAY	647	Input	DEFAULT: = 6 seconds. Range 1 to 3600 seconds	Status detection delay time in seconds. PCB over temperature delay threshold*
STATUS_PHASE_LOSS_ONSET	650	Input	DEFAULT: = 60 = 60 % Range 1 to 100	Filter output voltage phase loss onset threshold*
STATUS_PHASE_LOSS_CLEAR	651	Input	DEFAULT: = 65 = 65 % Range 1 to 100	Filter output voltage phase loss clear threshold*
STATUS_PHASE_LOSS_DELAY	652	Input	DEFAULT: = 6 seconds. Range 1 to 3600 seconds	Status detection delay time in seconds. Filter output voltage phase loss delay threshold*
STATUS_CPU_ERROR_DELAY	655	Input	DEFAULT: = 6 seconds. Range 1 to 3600 seconds	Status detection delay time in seconds. PCB processor CPU error delay*
STATUS_HIGH_THD_WARNING_ONSET	660	Input	DEFAULT: = 12 = 12 % Range 1 to 100	Filter output voltage high THD onset threshold*
STATUS_HIGH_THD_WARNING_CLEAR	661	Input	DEFAULT: = 11 = 11 % Range 1 to 100	Filter output voltage high THD clear threshold*
STATUS_HIGH_THD_WARNING_DELAY	662	Input	Status detection delay time in seconds. DEFAULT: = 6 seconds. Range 1 to 3600 seconds	Filter output voltage high THD delay threshold*
STATUS_MIN_DETECTION_VOLTAGE	670	Input	DEFAULT: = 5 = 5% of rated voltage Range 1 to 100	Minimum voltage to enable status detection*
FUND_MIN_TRACKING_VOLTAGE	680	Input	DEAULT: = 5 = 5% of rated voltage Range 1 to 100	Minimum voltage to enable output voltage tracking. If the filter output voltage is below this threshold the waveform data will be zeroed out and the metering data will report a value 65535 (or 0xFFFF)

				hex) to indicate data not available.*
FUND_TRACKING_MODE	681	Input	DEFAULT: = 0 Range 0 to 4 0=AC Coupling 1=DC and AC Coupling 2=DC Coupling 3=Fund Freq Tracking Disabled.	Fundamental frequency tracking mode. This parameter determines if the fundamental frequency tracking algorithm uses an AC coupled signal (dynamic DC nulling), a DC reference signal, a combination of both (DC first then AC) or does not track fundamental frequency
FUND_TRACKING_FILTER_GAIN	682	Input	DEFAULT: = 13 (~4Hz reference voltage filtering) Range 1 to 16	Fundamental frequency filter gain. This parameter sets how heavily the fundamental frequency reference voltage is filtered. A higher value is more filtering (lower frequency reference filter).
V_OUT_SCALAR_A	703	Input	DEFAULT: = 9639 Range -32768 to 32767	Adjusts filter output voltage scaling fir phase A-B*
V_OUT_SCALAR_B	704	Input	DEFAULT: = 9639 Range -32768 to 32767	Adjusts filter output voltage scaling fir phase B-C*
V_OUT_SCALAR_C	705	Input	DEFAULT: = 9639 Range -32768 to 32767	Adjusts filter output voltage scaling fir phase A-C*
V_OUT_A_OFFSET	708	Input	DEFAULT: = 2048 Range 0 to 4096	Adjusts filter output voltage offset for phase A-B*
V_OUT_B_OFFSET	709	Input	DEFAULT: = 2048 Range 0 to 4096	Adjusts filter output voltage offset for phase B-C*
V_OUT_C_OFFSET	710	Input	DEFAULT: = 2048 Range 0 to 4096	Adjusts filter output voltage offset for phase A-C*
T_PCB_SCALAR	741	Input	DEFAULT: = 12000 Range -32768 to 32767	PCB temperature scalar*
T_PCB_OFFSET	745	Input	DEFAULT: = 683 Range -8192 to 8192	PCB temperature offset*
V_LOAD_RMS_SCALAR	751	Input	DEFAULT: = 437 Range -32768 to 32767	Filter output RMS voltage scalar*
V_THD_SCALAR	802	Input	DEFAULT: = 16384 Range -32768 to 32767	Filter output voltage THD scalar*
V_THD_OFFSET	804	Input	DEFAULT: = 0 Range -32768 to 32767	Filter output voltage THD offset*

Table 27: Network Interface INPUT Register Map

SYS_NULL_EN	700	Input	0 = Disabled 1 = Enabled	System auto null calibration enable. This value auto clears to 0 when calibration complete.
SYS_SERIAL_NUM_2	810	Input	1301 = Sinewave Filter	Unit serial number section - upper 16 bits of 32-bit unit job number
SYS_SERIAL_NUM_1	811	Input	Parameter contains LLLL in the UUUULLLL-NN serial number format.	Unit serial number section - lower 16 bits of 32-bit unit job number
SYS_SERIAL_NUM_0	812	Input	Parameter contains NN in the UUUULLLL-NN serial number format.	Unit serial number section - two-digit unit number

Waveform Data

The waveform data displayed by the PQconnect is available in the Modbus Read Analog Input Register data space (function code 4) in the following addresses:

Table 28: Waveform Data

Waveform Phase	Waveform Start Address	Waveform Length
Phase A	0	512
Phase B	512	512
Phase C	1024	512

The waveform data is scaled in units of tenths of Volts. For example 6787 would equal 678.7 Volts.

Status Detection History Data

The Status Detection History data displayed by the PQconnect is available in the Modbus Read Analog Input Register data space (function code 4) at the following addresses:

Table 29: Status Detection History Data

Waveform Phase	History Record Start Address	History Record Length
History Record 0	1536	16
History Record 1	1552	16
History Record 2	1668	16
...
History Record 99	3136	16

The history record is circular buffer of 100 records from index 0 to 99. When the history buffer fills up the oldest record is overwritten. The newest entry in the history record is at index 0 and the oldest entry is at index 99.

A history record is logged each time the status detection parameter 210 value changes. Each history record is a collection of 16 bytes with the following format:

Table 30: History Records

Byte	Value	Format
0	Timestamp Seconds (4 bytes)	Seconds value of timestamp.
1		Timestamp seconds:milliseconds
2		value is the time since power on
3		of the event.

4	Timestamp Power Cycle Count	Range 0 to 255. Indicates the number times the PQconnect has been reset / power cycled.
5	Timestamp Milliseconds	Millisecond value of timestamp in units of 10s of milliseconds.
6	Detection Status	For format see Parameter 210 Detection Status
7		
8	Filter Output THVD Phase A	Filter Output Voltage THD at the time of the event in units of percent THD (100 = 100%)
9	Filter Output THVD Phase B	
10	Filter Output THVD Phase C	
11	Filter Output Average RMS Voltage	Filter output average RMS voltage in units of percent rated voltage (100=100% or nominal voltage).
12	Filter Output Voltage Fundamental	Fundamental Frequency divided by 2 in Hz. For example a value of 30 would equate to $30 \times 2 = 60\text{Hz}$ Fundamental Frequency. The factor of two is used to compress the 0 to 500Hz fundamental frequency value to fit in an 8 bit value.
13	Estimated Carrier Frequency	VFD Carrier frequency in units of 100Hz. For example a value of 20 would equate to a carrier frequency of $20 \times 100 = 2000\text{Hz}$. The factor 100 is used to compress the data to fit in an 8 bit value.
14	16 Bit, Two's Complement Checksum	History Record Checksum. When this 16 bit value is added together with the reset of the history records as 16 bit values the result should be zero if no data errors exist in the packet.
15		

PQconnect Hardware

Example Application Using “Simply Modbus Master 8.1.0”

The Modbus RTU network interface port is configured for RS-485 signal levels. The following example uses an RS-485 to USB converter to connect the PQconnect to a laptop PC running the Modbus RTU master application. The picture below shows an example “B&B SmartWorx, Inc Model: USPTL4” RS-485 to USB converter. As another alternative RS-485 converter there is WINGONEER USB 2.0 to RS485 Serial Converter Adapter CP2104.



Figure 12: B&B SmartWorx, Inc Model: USPTL4 model RS-422/485 converter

With the example converter above, the user can make proper connections from the RS485 converter to the PQconnect J5 communication header. The table below indicates the positions where the RS485 connections lead to. Please ensure the correct dip switch settings are applied before installing.

Table 31: USPTL4 to J5 Header Connections

J5 Header Pinout	B&B Converter USPTL4Pin Out	Signal Name	Signal Type
1	-	No connect	-
2	TDB(+)	D+	RS-485 B (non-inverting)
3	GND	GND	RS-485 SC/G
4	TDA(-)	D-	RS-485 A (inverting)
5	-	No connect	-

USPTL4 RS485 Converter Dip Switch settings

All four switches of the B&B converter from the factory should be set to the ON position and should look like the following.

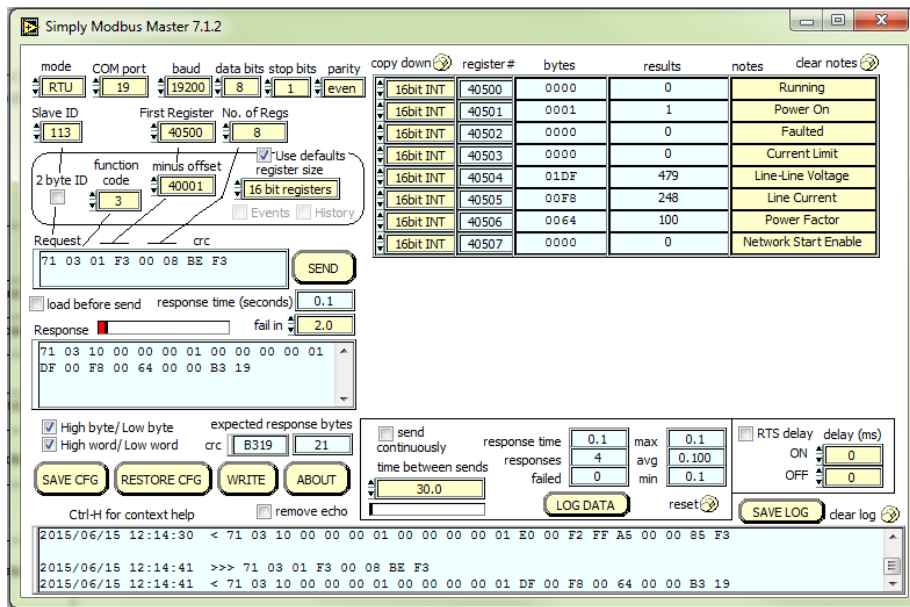

Figure 13: Dip Switch settings

Example Setup Instructions to Read Data from the PQconnect Unit:

- Connect the cable to the communication header on the side of the board
- Connect USB end to the computer
 - Determine the assigned COM port number for the RS-485 to USB converter using the computer device manager control panel.
 - The converter used in this example typically enumerates between the range of COM5 to COM20 on a standard laptop computer running the Microsoft windows operating system
- Open the Simply Modbus Master software
 - Can be downloaded from the link below:
 - <http://www.simplymodbus.ca/manual.htm>
 - The trial version of the software is free and fully functional for this task hence no License key is necessary
- Next, configure the fields in the screen as shown below. These are again the default settings of the PQconnect COM port.
 - Note: The “notes” section of the display data registers are filled in manually

Example Setup Instructions to Write Data to the PQconnect Unit:



- To change the voltage rating of the unit, first gain tech access by writing the parameter keys.
- Select the “WRITE” button on the screen shown above.
- The screen below will be shown. Configure the fields as shown in the picture.

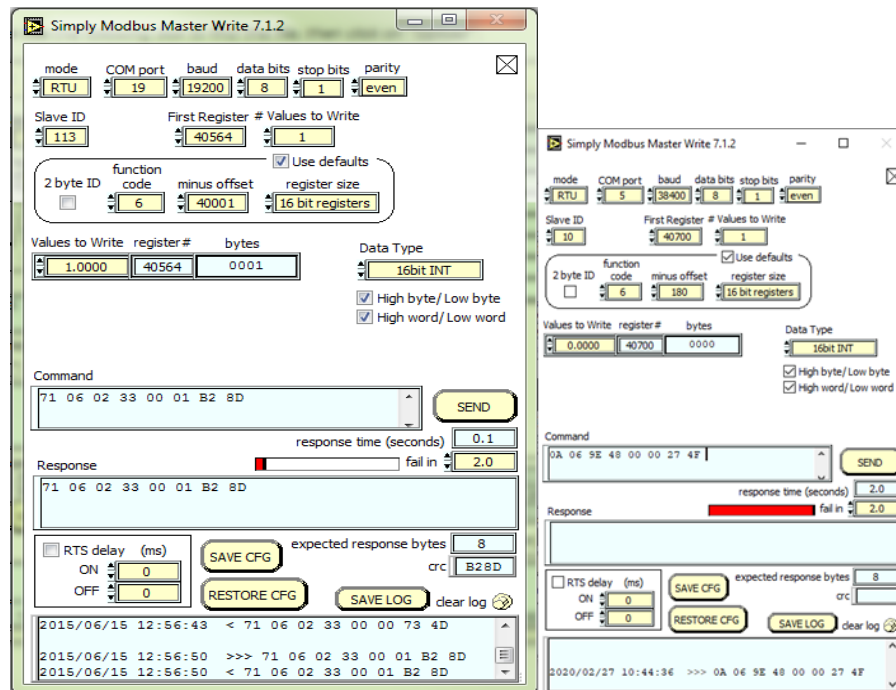

- Select 4800 in the field “Values to Write” to change the voltage rating of the unit to 480 Vrms.

PCB Connections

Most customer connections to PQconnect will be made on the PCB. Refer to connection diagram below and to drawing 24281-1PQ for the wiring schematic. The details of the power and communications terminals are shown in the table below. Form C relays are available on the PCB, these connections are shown in Table 32. Two relay outputs are available on the PCB.

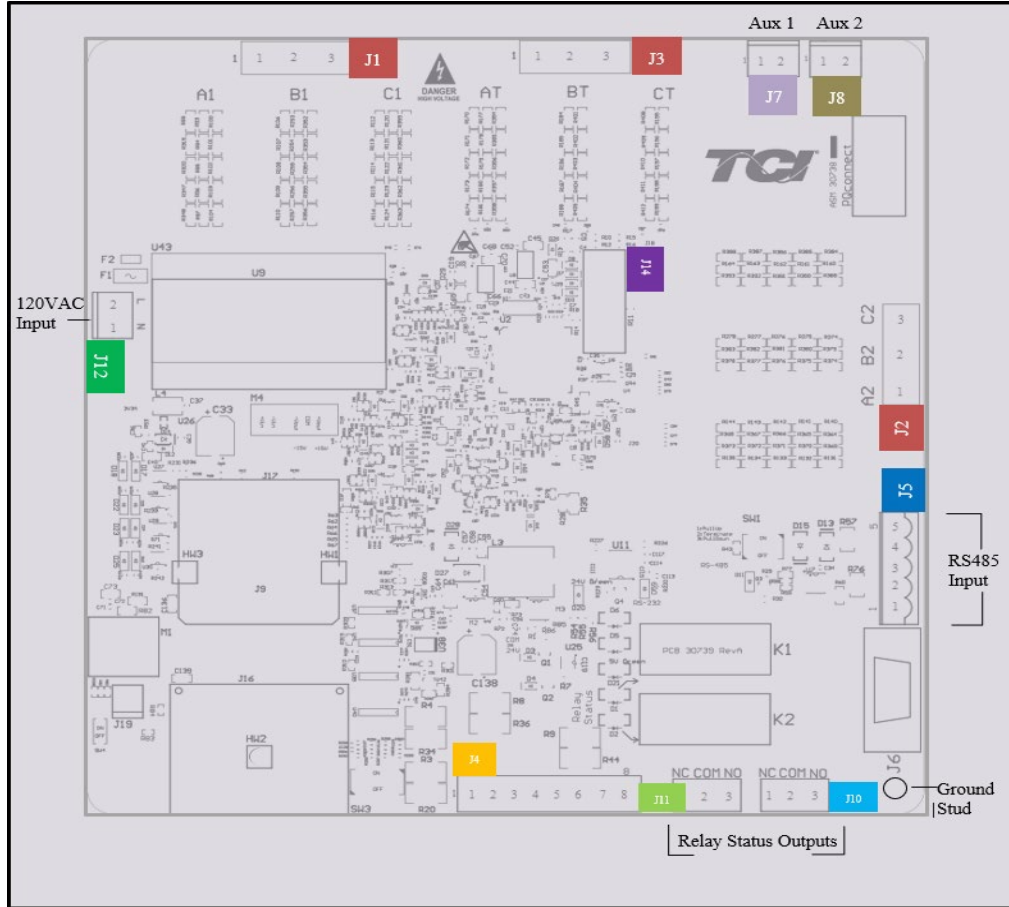

Figure 14: PQconnect Connections

Table 32: Form C Relay Contacts

Terminal	Pin	Description	Label	Tightening Torque	Wire Range
J7	1, 2	Reactor Thermal Switch	Customer contacts	3.5 lb-in (0.4 Nm)	28-12 AWG
J8	1, 2	Optional Reactor Thermal Switch	Customer contacts	3.5 lb-in (0.4 Nm)	28-12 AWG
J11	1	Output Relay 1	Normally Closed	4.4 lb-in (0.5 Nm)	28-14 AWG
	2		Common		
	3		Normally Open		
J10	1	Output Relay 2	Normally Closed	4.4 lb-in (0.5 Nm)	28-14 AWG
	2		Common		
	3		Normally Open		

Note: Form-C relay contacts are gold plated with a load rating of 5.0A @ 120VAC

Table 33: Power & Communication Terminals

Terminal	Pin	Description	Label	Rating
J1	1	Tuning Reactor Output Connections	Phase A	600VAC
	2		Phase B	
	3		Phase C	
J2	1	Tuning Reactor Connections	Phase A (Output of Tuning reactor)	600VAC
	2		Phase B (Input of Tuning Reactor)	
	3		Not connected	
J3	1,2,3	Not Connected		N/A
J4	1-8	Not Connected		N/A
J5	1	RS485	Not Connected	N/A
	2		B (non-inverting)	
	3		Ground	
	4		A (inverting)	
	5		Not connected	
J12	1	Input Power from control power transformer	Neutral	120 VAC
	2		Line	
J14	1-14	Micro Programming	For factory use	N/A

Note: The power terminals on the PQconnect accepts 28 to 14 AWG stranded wire, with a tightening torque of 4.4 in-lb (0.5 Nm).

Note: The PQconnect board needs to be earth grounded via the plated metal mounting hole on the corner of the board near J16. The board mounting standoff used on this mounting hole must be metal and connected to unit chassis earth ground. The PQconnect board must be grounded via the ground stud whenever the KMG filter with PQconnect is energized.

Troubleshooting

<p>Warning</p> 	<p>Only qualified electricians should carry out all electrical installation & maintenance work on the Sine wave filter.</p> <p>Disconnect all sources of power to the KMG and connected equipment before working on the equipment. Do not attempt any work on a powered KMG.</p> <p>The KMG unit contains high voltage and capacitors. Wait at least five minutes after disconnecting power from the filter before attempting to service the conditioner. Check for zero voltage between all terminals on the capacitors. Also, check for zero voltage between all phases of the input and output lines. All maintenance and troubleshooting must be done by a qualified electrician. Failure to follow standard safety procedures may result in death or serious injury. Unless an external disconnect means has been provided everything ahead of the filter circuit breaker, including the reactors, will still be energized.</p>
---	---

Receiving Inspection

The connectivity board has been thoroughly inspected and functionally tested at the factory and carefully packaged for shipment. After receiving the unit, immediately inspect the shipping container and report any damage to the carrier that delivered the unit. Verify that the part number of the unit received is the same as the part number listed on the purchase order.

Connectivity Board Problem

The KMG is comprised of three major components; the PQconnect connectivity board, the tuning reactor, and the capacitors. The PQconnect PCB contains diagnostic LEDs. The locations of the LEDs are shown Figure 14 and their functions are listed in Table 34.

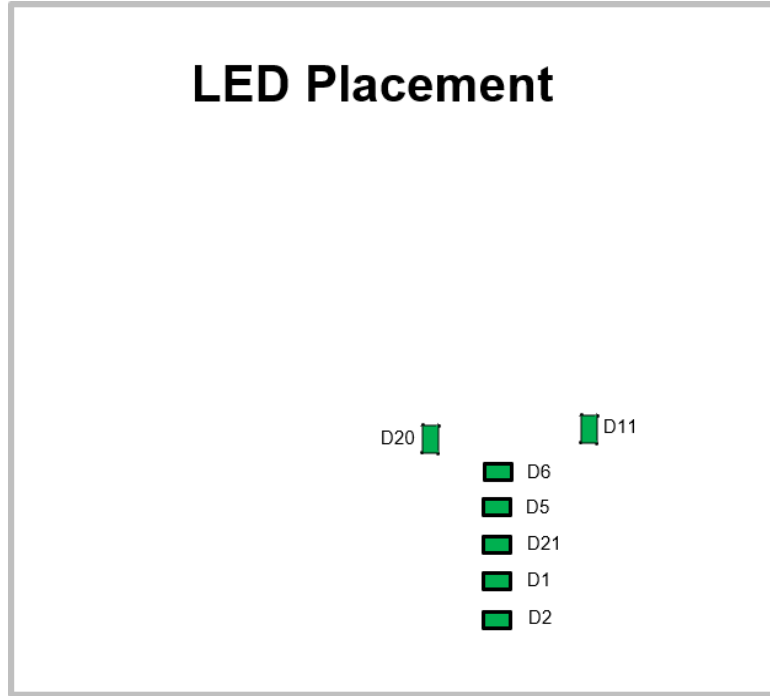

Figure 15: PQconnect LED Placements

Table 34: LED Functions

LED	LED Color	Description
D1	Green	Output Relay 1
D2	Green	Output Relay 2
D5	Green	Detection Status LED
D6	Green	Microprocessor Status LED
D11	Green	RS485 Communication is active
D20	Green	24V LED
D21	Green	5V LED

Note: Status LED's will blink according to the filter status. The microprocessor status LED will blink 1hz if the filter is okay, however if there has been an alert the LED will blink according to the status detection. It will initially start with slow blinks (3 = Filter Status Detections), then blink fast depending on the fault. The table below summarizes the LED blinks based on the fault condition.

Table 35: D6 LED Codes Microprocessor Status LED)

Status	LED Specifier
No fault detected/ enabled	LED Blinking at 1Hz
PCB Not Calibrated	LED Solid On
Status Detection Active	LED Solid Off

Table 36: D6 LED Codes (Detection Status LED)

Detection	LED Specifier (On/Off or Slow - Fast Blink Sequence)
No fault detected/ enabled	LED Solid Off
PCB Not Calibrated	LED Solid On
Overvoltage Phase A	3 – 1
Overvoltage Phase B	3 – 2
Overvoltage Phase C	3 – 3
High THVD Phase A	3 – 4
High THVD Phase B	3 - 5
High THVD Phase C	3 - 6
Thermal Switch 1	3 - 7
Thermal Switch 2	3 - 8
PCB Under Temperature	3 - 9
PCB Over Temperature	3 - 10
Phase Loss A	3 - 11
Phase Loss B	3 – 12
Phase Loss C	3 – 13
CPU Error	3 – 16

Communication Problems

- J5 Communication Header
 - With the power de-energized from the filter, check wiring leading to J5 header
 - If the user is using a different RS485 converter than the example above, please follow the datasheet for the A & B signals and ground for proper setup
- Ensure the drivers of the RS485 to USB converter is installed to the computer. Simple way of checking while the RS485 converter connected is to go to the device manager and scroll down to ports. There will be a device connected to the ports. If your device is not listed, the user will need to install the correct drivers of the RS485 converter.

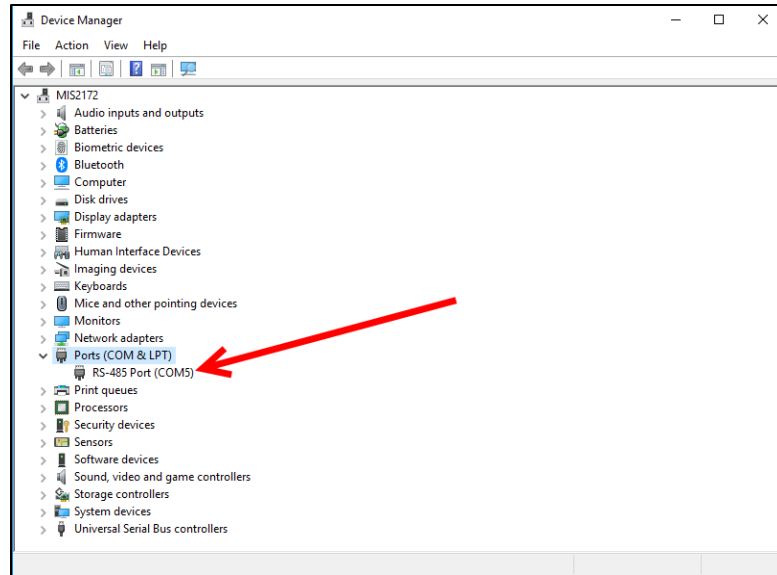
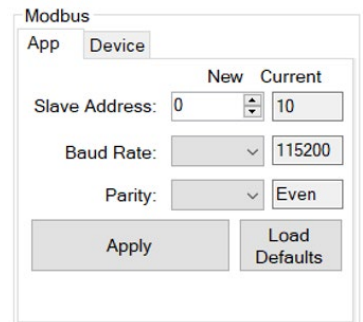

Figure 16: RS-485 Port In Device Manager

- PQvision App Load Defaults
 - With the RS485 Converter connected to the circuit board
 - Energize Filter
 - Open PQvision desktop interface
 - Go to **Settings**
 - Select Load Defaults
 - Select Apply
 - Default Modbus settings should be applied. Try connecting to the COM port
 - If this doesn't work de-energize power to the filter and try flipping the A and B signal wires leading to the J5 header of the circuit board.
- Hard Reset Modbus settings (Worst Case)
 - To perform a hard reset of Modbus settings the user will need to remove jumper J20 with the power de-energized from the filter. Once the jumper is removed connect the RS485 converter to J5 header and energize filter.
 - Open PQvision
 - Confirm there is a COM port under Communication and try to connect
 - Note if connecting to the COM port does not work, try flipping the A and B signal wires leading to the J5 header of the circuit board
 - Load defaults and apply
 - Save settings and de-energize filter
 - Connect jumper to J20
 - Energize filter
 - Try connecting to PCB
 - All Modbus settings should be set to default settings at this point
 - If the board doesn't connect after trying hard reset contact TCI Tech-Support



PCB Calibration Process

If the user needs to calibrate the PCB than they will need to follow the steps below. Note: an RS485 to USB converter, a windows computer, and PQvision will be needed for the calibration. Before energizing the filter, the user should connect the RS485 to USB converter to the PCB.

Power will need to be energized to the PCB for the calibration process.

- Step 1. Energize unit
- Step 2: Open PQvision desktop application
- Step 3: Connect to the device by selecting the appropriate “COM port”
- Step 4. Go to “Menu” and select “Tech access”

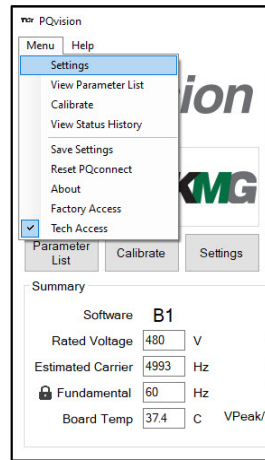

Figure 17: PQvision Main Menu

- Step 5: Go to “Menu” and select “Calibrate”

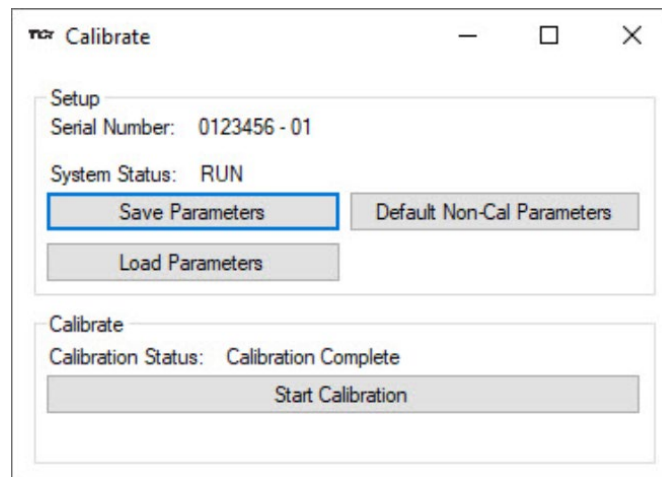

Figure 18: Calibration Screen

- Step 6: Select “Default Non-Cal Parameters”
- Step 7: Select “Start Calibration”
 - Note: Calibration will take about 1-2 minutes
- Step 8: After the calibration is complete, select “Save Parameters”

Debug Status Conditions

Based on the fault condition there are various ways a fault can appear. **Before investigating the sine wave filter internally, disengage supply voltage to the filter.**

Debug Fault conditions

Based on the fault condition there are various ways a fault can appear. **Before investigating the sine wave filter internally, disengage supply voltage to the filter.**

Table 37: Fault conditions

Fault Condition	Description	Debug
Overvoltage Phase A, B, or C	Filter has detected overvoltage on a phase(s)	Check input power connections to the filter.
Phase Loss Phase A, B, or C	Filter phase loss	Check fused disconnect or circuit breaker upstream of the filter. Check input power connections to the filter
High THVD Phase A, B, or C	High voltage Total Harmonic Distortion	Check fuses leading to filter capacitors If fuses are not blown, measure Capacitance of the capacitors Check power connections of the unit, reference drawing 24281-1PQ
PCB Under Temperature	Filter ambient temperature is operating below threshold	Check fuses of control power transformers leading to the heater.
PCB Over Temperature	Filter ambient temperature is operating above threshold	Check fuses of control power transformers leading to fans. Make sure fans are operating
CPU Error	Processor malfunction	Power cycle unit and if issue persists contact tech support
Reactor Switch	Reactor Thermal Switch open	Check thermal switch connections to PCB; Reactor switch is a normally closed switch that opens if reactor overheats.

6.0 Maintenance and Service

Evaluating MotorGuard Performance

The MotorGuard performance can be evaluated by checking the output voltage waveform with an oscilloscope.

<p>Warning</p> 	<p>Only qualified electricians should carry out all electrical installation and maintenance work on the MotorGuard.</p> <p>Exercise caution when checking waveforms with an oscilloscope.</p> <p>Use a dual probe, differential input set-up, or other means of isolating the scope chassis from the motor voltage.</p> <p>Disconnect power when attaching and removing the probes.</p>
---	---

MotorGuard Reliability and Service Life

The MotorGuard has been designed to provide a service life that equals or exceeds the life of the variable frequency drive. It has been thoroughly tested at the factory to ensure that it will perform reliably from the moment it is put into service. The following periodic maintenance is recommended to ensure that the MotorGuard will always perform reliably and provide the expected service life.

Periodic Maintenance

<p>Warning</p> 	<p>Only qualified electricians should carry out all electrical installation and maintenance work on the MotorGuard.</p> <p>Disconnect all sources of power to the VFD and MotorGuard before working on the equipment. Do not attempt any work on a powered MotorGuard.</p>
--	--

Check to see that the installation environment remains free from exposure to excessive dirt and contaminants. Refer to the **Pre-installation Planning** section of this manual.

Check to make sure that the enclosure ventilation openings are clean and unobstructed.

Clean the air filter in units that have filtered air inlets. Clean as often as necessary to prevent dirt build-up from impeding air flow.

Inspect the interior of the enclosure for signs of overheated components. Clean the interior of the enclosure whenever excess dirt has accumulated.

Check the integrity of all power, ground, and control wiring connections.

All electrical connections must be re-torqued annually.

Replacement Parts

If replacement parts are needed, please contact your TCI representative. To ensure that the MotorGuard continues to perform to its original specifications, replacement parts should conform to TCI specifications.

Factory Contacts and Tech Support

For technical support, contact your local TCI distributor or sales representative.

You can contact TCI directly at 800-824-8282. Select "Customer Service" or "Technical Support" and have your MotorGuard nameplate information available.



TCI, LLC
W132 N10611 Grant Drive
Germantown, Wisconsin 53022

Phone: 414-357-4480
Fax: 414-357-4484
Helpline: 800-824-8282
Web Site: www.transcoil.com
© 2020 TCI, LLC All rights reserved

Product No: 24362 Effective: 06-01-2021 Version: 1.3

