



www.saftronics.com

PC10

**Mini-Vector
AC Drive**



INSTRUCTION MANUAL

These instructions do not purport to cover all details or variations in equipment, nor to provide every possible contingency to be met during installation, operation, and maintenance. If further information is desired, or if particular problems arise that are not covered sufficiently for the purchaser's purpose, the matter should be referred to Saftronics, INC., Ft. Myers, FL

This document contains proprietary information of Saftronics and is furnished to its customer solely to assist that customer in the installation, testing, operation, and/or maintenance of the equipment described. This document shall not be reproduced in whole or in part, nor shall its contents be disclosed to any third party without the written approval of Saftronics INC.

WARNING:

This equipment contains a potential hazard of electric shock or burn. Only personnel who are adequately trained and thoroughly familiar with the equipment and the instructions should install, operate, or maintain this equipment.

Isolation of test equipment from the equipment under test presents potential electrical hazards. If the test equipment cannot be grounded to the equipment under test, the test equipment's case must be shielded to prevent contact by personnel.

To minimize hazard of electrical shock or burn, approved grounding practices and procedures must be strictly followed.

WARNING:

To prevent personal injury or equipment damage caused by equipment malfunction, only adequately trained personnel should modify any programmable machine.

Table of Contents

i. Preface		7. Troubleshooting	7-1
Cautions	ii	Protective Function Activation	7-1
General Precautions	iv	Abnormal Motor Rotation	7-5
Compliance with UL/cUL Standards	v	8. Maintenance and Inspection	8-1
Model Numbering System Diagram	vii	Daily Inspection	8-1
Weights & Dimensions	viii	Periodic Inspection	8-1
1. Before Using the Drive	1-1	Measurement of Electrical Amounts in Main Circuit	8-3
Receiving Inspection	1-1	Insulation Test	8-4
External View of Product	1-1	Replacement Parts	8-4
Handling the Product	1-3	9. Warranty, Parts and Service	9-1
Transportation	1-6	Warranty Coverage	9-1
Storage	1-6	Out of Warranty Procedures	9-1
Rating Efficiency and Watts Loss	1-7	Motors	9-1
2. Installation and Connection	2-1	In-Warranty Failure Check List	9-2
Operating Environment	2-1	10. Replacement Parts	10-1
Installation Method	2-1	11. Specifications	11-1
Connection	2-2	Standard Specifications	11-1
Basic Connection	2-2	Common Specifications	11-4
Connection of Main Circuit and Grounding Terminal	2-4	External Dimensions	11-8
Connection of Control Terminal	2-6	12. RS485 RTU Serial Communication	12-1
Terminal Layout	2-9	Outline	12-1
3. Operation	3-1	Communication Specification	12-1
Inspection and Preparation Before Operation	3-1	Connection	12-2
Operation Method	3-1	Message Format	12-4
Test Operation	3-1	Message Type	12-4
4. Keypad Panel	4-1	Message Frame	12-4
Appearance of Keypad Panel	4-1	CRC-16	12-6
Upon an Alarm	4-3	Sort of Messages	12-9
Digital Frequency Setting Method	4-3	Transmission Error	12-12
5. Selecting Functions	5-1	Functions Specific for Communication	12-16
Function Selection List	5-1	Function Data Format	12-19
Detailed Description of Each Function	5-6	Data Format Specification	12-22
Fundamental Functions (F Functions)	5-6	Changeover of Communication	12-28
Extension Terminal Functions (E Functions)	5-18	Response Time	12-30
Control Functions of Frequency (C Functions)	5-24	13. Compliance with Standards	13-1
Motor Parameters (P Functions)	5-27	UL/cUL standards	13-1
High Performance Functions (H Functions)	5-29	Electromagnetic Compatibility	13-1
Alternative Motor Parameters (A Functions)	5-38	Compliance with Low Voltage Directive in EU	13-4
6. Protective Operation	6-1		
List of Protective Operations	6-1		
Alarm Reset	6-2		

CAUTION

- This product is designed to drive a three-phase induction motor. Read through this instruction manual and be familiar with the handling method for correct use.
- Improper handling may cause mis-operation and shorten the life of the product.
- This manual should be delivered to the user of the product. This manual should be kept in a safe place until the drive is de-commissioned.
- Refer to additional manuals for optional equipment.

Introduction

Safety precautions

Read through this manual before starting installation, connection (wiring), operation, maintenance or inspection. Be familiar with the device, information about safety, and all the precautions before starting operation.

The safety precautions are classified into the following categories in this manual.

DANGER

Negligence in following precautions of this type can cause death or serious injuries.

CAUTION

Negligence in following precautions of this type can cause dangers including intermediate injuries or material losses.

Negligence in following precautions of this type under the CAUTION title can cause serious results in certain circumstances. These safety precautions are important and must be observed at all times.

Purposes

DANGER

- PC10 is designed to drive a three-phase induction motor. It should not be used for single-phase motors or other purposes, **otherwise fire could occur.**
- PC10 may not be used for a life-support system or other purposes directly related to human safety.
- Though PC10 is manufactured under strict quality control, safety devices should be installed for applications where serious accidents or material losses are possible.

Installation

DANGER

- Install the drive on a nonflammable material such as metal, **otherwise fire could occur.**
- Do not place flammable material nearby, **otherwise fire could occur.**

CAUTION

- Do not carry the drive via the cover, **otherwise the drive may drop and cause injuries.**
- Do not allow lint, paper, wood chips, dust, metallic chips or other foreign matter into the drive or do not allow them to attach to the heat sink, **otherwise fire or accident could occur.**
- Do not install or operate a drive which is damaged or missing parts, **as fire, accident or injuries could occur.**

Wiring

DANGER

- When connecting the drive to the power supply, add a circuit breaker with ground fault protection, **otherwise fire could occur.**
- Be sure to connect the grounding cable, **otherwise electric shock or fire could occur.**
- Qualified electricians should perform the wiring, **otherwise electric shock could occur.**
- Initiate wiring after checking that the power supply is turned off, **otherwise electric shock could occur.**
- Begin wiring after mounting the main body of the drive, **otherwise electric shock or injuries could occur.**
- Both grounding terminals of 7.5/10 Hp drives have to be tightened securely, even if one grounding terminal is used, **otherwise electric shock or fire could occur.**

CAUTION

- Check that the number of phases and the rated voltage of the product agree with the phases and the voltage of the AC power supply, **otherwise fire or an accident could occur.**
- Do not connect the AC power cables to the output terminals (U, V, W), **otherwise fire or an accident could occur.**
- Do not connect a braking resistor directly to the DC terminals (P (+), N (-)), **otherwise fire or an accident could occur.**
- The drive, motor and wiring generate electrical noise. Take care installing nearby sensors and devices, **otherwise an accident could occur.**

Operation

DANGER

- Be sure to install the drive cover before turning the power on. Do not remove the cover while power is applied, **otherwise electric shock could occur.**
- Do not operate switches with wet hands, **otherwise electric shock could occur.**
- If the retry function has been selected, the drive may automatically restart after tripping.
(Design the machine so that human safety is ensured after restarting, **otherwise an accident could occur.**)
- If the torque limit function has been selected, the drive may operate at an acceleration/deceleration rate or speed different from the set ones. Design the machine so that safety is ensured even in such cases, **otherwise an accident could occur.**
- The STOP key is only effective when a function code setting has been established to make the STOP key enabled. Prepare an emergency stop switch separately, **otherwise an accident could occur.**
- If an alarm reset is made with the reference signal present, a sudden start will occur. Check that the reference signal is turned off in advance, **otherwise an accident could occur.**
- Do not touch the drive terminals while power is applied to the drive even if the drive stops, **otherwise electric shock could occur.**

CAUTION

- Do not turn the main circuit power on or off to start or stop drive operation, **otherwise failure could occur.**
- Do not touch the heat sink and braking resistor as they may become very hot, **and burns could occur.**
- Check the performance of the motor and machines before running the drive at high speed, **otherwise injuries could occur.**
- The brake function of the drive does not provide mechanical holding means, **therefore injuries could occur if precautions are not taken.**

DANGER

- Turn the power off and wait for at least five minutes before starting inspection.
(Check that the charge lamp is not lit, and check that the DC voltage across the P (+) and N (-) terminals is lower than 25Vdc, **otherwise electric shock could occur.**)
- Maintenance, inspection and parts replacement should be made only by qualified persons.
(Take off watches, rings and other metallic items before starting work.)
(Use insulated tools.)
Otherwise electric shock or injuries could occur.

Disposal

CAUTION

- Handle the drive as an industrial waste when disposing of it, **otherwise injuries could occur.**

Others

DANGER

- Never re-work the drive, **otherwise electric shock or injuries could occur.**

General Precautions

Drawings in this manual may be illustrated without covers or safety shields for clearer explanation. Restore the covers and shields to the original state and observe the description in the manual before starting operation.

Compliance with low voltage directive in EU [Applicable to products with CE or TÜV mark]

- Safe separation for control interface of this drive is provided when this drive is installed in overvoltage category II. PELV(Protective Extra Low Voltage) circuit or SELV(Safety Extra Low Voltage) circuit should be connected to the interface directly.
- Basic insulation for control interface of this drive is provided when this drive is installed in overvoltage category III. An insulation transformer has to be installed between power supply mains and this drive when SELV circuit is connected to this drive directly. Otherwise supplementary insulation between control interface of this drive and environment must be provided.
- The ground terminal G should always be connected to the ground. Don't use RCD as the sole method of electric shock protection. Sizing of external PE (ground) conductor should be the same size as the input phase conductor and capable of the same fault currents.
- Use MCCB or MC that conforms to EN or IEC standard.
- Where RCD (Residual-current-operated protective device) is used for protection of direct or indirect contact, only **RCD of type B** is allowed on the supply side of this EE (Electric equipment). Otherwise other protective measures shall be applied such as separation of the EE from the environment by double or reinforced insulation or isolation of EE and supply system by a transformer.
- The drive has to be installed in environment of pollution degree 2. If the environment is pollution degree 3 or 4, the drive has to be installed in a cabinet of IP54 or higher.
- Use prescribed wire according to the EN60204

Appendix C.

- Install the drive, AC or DC reactor, output filter in an enclosure that meets the following requirements.
 - 1) When a person can easily touch connecting terminals or live parts, install the device in an enclosure with minimum of IP4X degree of protection.
 - 2) When a person can not easily touch connecting terminals or live parts, install the device in an enclosure with a minimum of IP2X degree of protection.
- If it is necessary to install the drive with an appropriate RFI filter to conform to the EMC directive, it is the customer's responsibility to check whether the equipment is installed in accordance with EMC directives.
- Do not connect copper wire to ground terminals directly. Use crimp terminals with tin or equivalent plating to reduce electrochemical action.
- Do not remove the keypad panel before disconnecting power and do not insert/remove the extension cable for remote keypad panel while power is on. Confirm that the extension cable is securely latched to keypad panel and the drive.
- Basic insulation for control interface of this drive is provided at altitudes up to 3000m. Use at altitudes over 3000m is not permitted.
- The neutral of the power supply has to be grounded for 460V input.

Compliance with UL/cUL standards [Applicable to products with UL/cUL mark]

CAUTION

1. [WARNING] Be sure to turn the drive off before starting work.
2. [CAUTION] When the charge lamp is lit, the drive is still charged at a dangerous voltage.
3. [WARNING] There are several live parts inside the drive.
4. The drive is approved as a part to be used inside a panel.
5. Wire to the input, output and control terminals of the drive, referring to the table below. Use UL certified round crimp terminals on the input and output terminals with insulation cover removed to obtain the correct insulation distance. Use a crimping tool recommended by the terminal manufacturer.
6. Install a fuse or circuit breaker between the power supply and the drive, using the table below.

Voltage	Drive type	Tightening torque inch-Lbs [N-m]		Applicable wire diameter [AWG] ¹		Fuse ² [A]	Breaker [A]		
		L1/R,L2/S,L3/T L1/L, L2/N P1,P(+) DB,N(-) U, V, W	Control section	L1/R,L2/S,L3/T L1/L, L2/N P1,P(+) DB,N(-) U, V, W	Control section				
Three-phase 230 VAC input	PC10E1ST32F12 **	10.6 (1.2)	3.5 (0.4)	14	20	3	5		
	PC10E1ST32F25 **					6	5		
	PC10E1ST32F50 **					10	10		
	PC10E1ST32001 **					15	15		
	PC10E1ST32002 **	15.9 (1.8)				20	20		
	PC10E1ST32003 **					30	30		
	PC10E1ST32005 **					40	40		
	PC10E1ST32007 **					50	50		
	PC10E1ST32010 **	31.0 (3.5)				8	50	50	
PC10E1ST32010 **		16	60	60					
Single-phase 230 VAC input	PC10E1ST12F12 **	10.6 (1.2)	3.5 (0.4)	14	20	6	5		
	PC10E1ST12F25 **					6	5		
	PC10E1ST12F50 **					10	10		
	PC10E1ST12001 **	15.9 (1.8)				15	15		
	PC10E1ST12002 **					30	30		
	PC10E1ST12003 **					40	40		
Three-phase 460 VAC input	PC10E1ST34F50 **	15.9 (1.8)	3.5 (0.4)	14	20	6	5		
	PC10E1ST34001 **					10	10		
	PC10E1ST34002 **							15	15
	PC10E1ST34003 **							20	20
	PC10E1ST34005 **							30	30
	PC10E1ST34007 **	31.0 (3.5)				12	30	30	
	PC10E1ST34010 **					10	40	40	

1) Use copper wires with allowable maximum temperature 60 to 75 degree C.

2) Use UL certified AC600V "Class J fuse."

** Indicates factory use

CAUTION

7. The PC10, 230V drives are suitable for use on a circuit capable of delivering not more than 20,000 rms symmetrical amperes, 240V maximum.
8. The PC10, 460V drives are suitable for use on a circuit capable of delivering not more than the following symmetrical amperes 480V maximum: When a fuse is installed 20,000A, when the circuit breaker is installed 5000A.
9. PC10 is an open type drive.
10. A class 2 circuit wired with class 1 wire.

PC10™ Model Numbering System Diagram

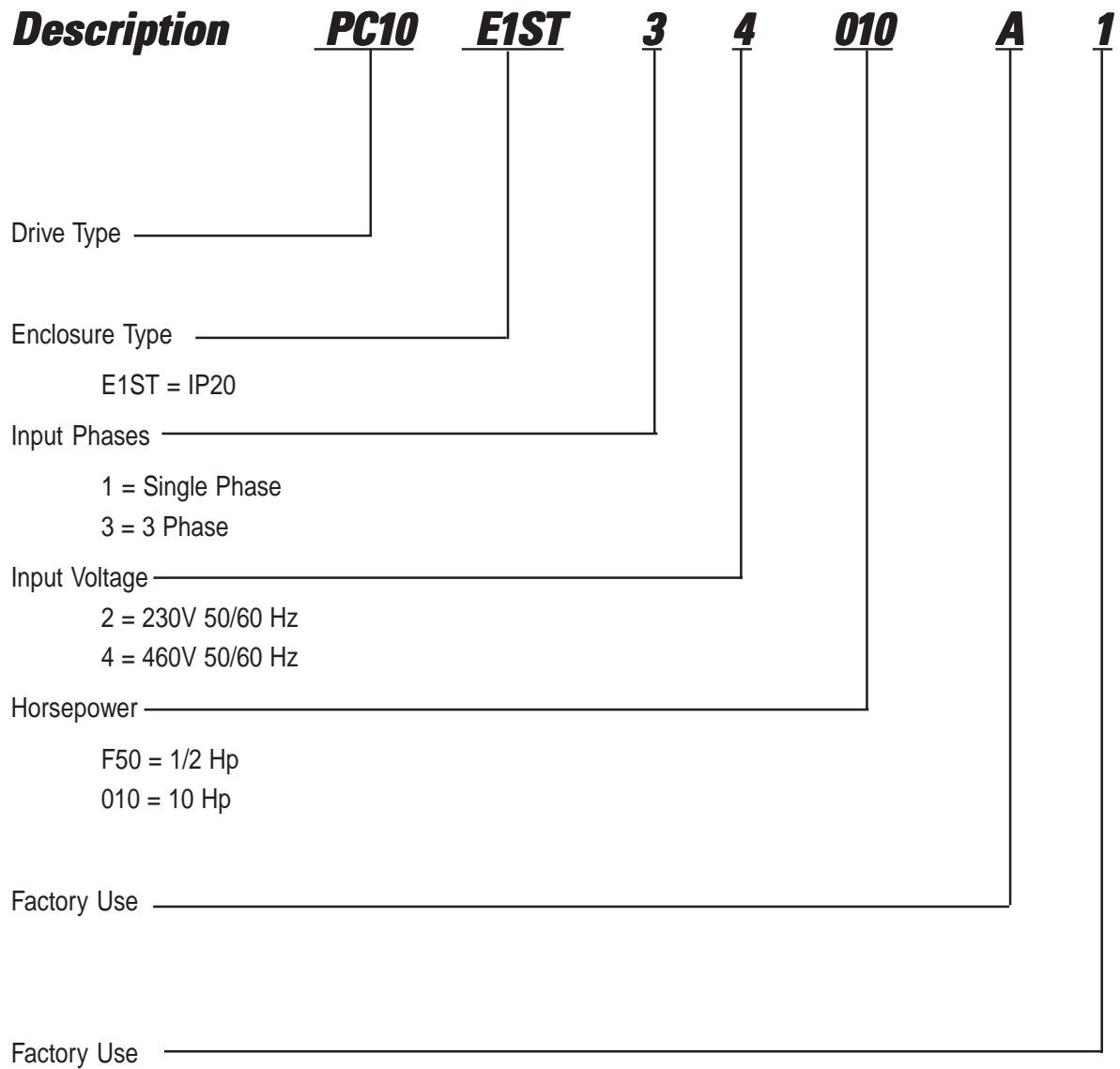

PC 10 Weights & Dimensions

HP Rating	Enclosure	Output Current (A)	Overload (A) (150% 1min.)	Model No.	Part No.	Dimensions H x W x D (inches)	Weight (lbs)
-----------	-----------	--------------------	---------------------------	-----------	----------	-------------------------------	--------------

230VAC, 3 phase, 50/60Hz Input

1/8	IP20	0.7	1.1	PC10E1ST32F12 **	PC102F12-9	5.12 x 2.76 x 3.78	1.3
1/4	IP20	1.4	2.1	PC10E1ST32F25 **	PC102F25-9	5.12 x 2.76 x 3.98	1.3
1/2	IP20	2.5	3.8	PC10E1ST32F50 **	PC102F50-9	5.12 x 2.76 x 4.65	1.5
1	IP20	4.0	6.0	PC10E1ST32001 **	PC102001-9	5.12 x 2.76 x 5.67	1.8
2	IP20	7.0	10.5	PC10E1ST32002 **	PC102002-9	5.12 x 4.18 x 5.91	2.9
3	IP20	10.0	15.0	PC10E1ST32003 **	PC102003-9	5.12 x 4.18 x 5.91	2.9
5	IP20	16.5	24.8	PC10E1ST32005 **	PC102005-9	5.12 x 6.69 x 6.22	4.4
7.5	IP20	23.5	35.3	PC10E1ST32007 **	PC102007-9	8.66 x 7.09 x 6.22	9.9
10	IP20	31.0	46.5	PC10E1ST32010 **	PC102010-9	8.66 x 7.09 x 6.22	9.9

230VAC, Single phase, 50/60Hz Input

1/8	IP20	0.7	1.1	PC10E1ST12F12 **	PC102F12-91	5.12 x 2.76 x 3.78	1.3
1/4	IP20	1.4	2.1	PC10E1ST12F25 **	PC102F25-91	5.12 x 2.76 x 3.98	1.5
1/2	IP20	2.5	3.8	PC10E1ST12F50 **	PC102F50-91	5.12 x 2.76 x 4.65	1.5
1	IP20	4.0	6.0	PC10E1ST12001 **	PC102001-91	5.12 x 4.18 x 4.96	2.6
2	IP20	7.0	10.5	PC10E1ST12002 **	PC102002-91	5.12 x 6.69 x 6.22	4.0
3	IP20	10.0	15.0	PC10E1ST12003 **	PC102003-91	5.12 x 6.69 x 6.22	4.2

460VAC, 3 phase, 50/60Hz Input

1/2	IP20	1.4	2.1	PC10E1ST34F50 **	PC104F50-9	5.12 x 4.18 x 4.96	2.4
1	IP20	2.1	3.2	PC10E1ST34001 **	PC104001-9	5.12 x 4.18 x 5.91	2.6
2	IP20	3.7	5.6	PC10E1ST34002 **	PC104002-9	5.12 x 4.18 x 6.69	2.9
3	IP20	5.3	8.0	PC10E1ST34003 **	PC104003-9	5.12 x 4.18 x 6.69	3.1
5	IP20	8.7	13.1	PC10E1ST34005 **	PC104005-9	5.12 x 6.69 x 6.22	4.2
7.5	IP20	12	18.0	PC10E1ST34007 **	PC104007-9	8.66 x 7.09 x 6.22	9.9
10	IP20	16	24.0	PC10E1ST34010 **	PC104010-9	8.66 x 7.09 x 6.22	9.9

** Indicates factory use

1. Before Using the Drive

1.1 Receiving Inspection

If you have any problems with the product, contact the distributor or Safronics.

Unpack and check the following items.

- (1) Check the ratings nameplate to confirm that the delivered product is the ordered one.

SOURCE: Number of input phases, input voltage, input frequency, input current

OUTPUT: Number of output phases, rated output capacity, rated output voltage, output frequency range, rated output current, overload current rating

SER. NO.: Product number

0 9 0 1 1 3 R 0 0 0 1

Serial number of production lot
Production month: 1 to 9: January to September; X, Y, or Z: October, November, or December
Production year: Last digit of year

- (2) Check for breakage, missing parts, and dents or other damage on the cover and the main body given during transportation.
- (3) Instruction manual for the drive is included.

SAFRONICS PC10
MODEL
INPUT
OUTPUT
SER. NO.
Made in Japan

1.2 External view of Product

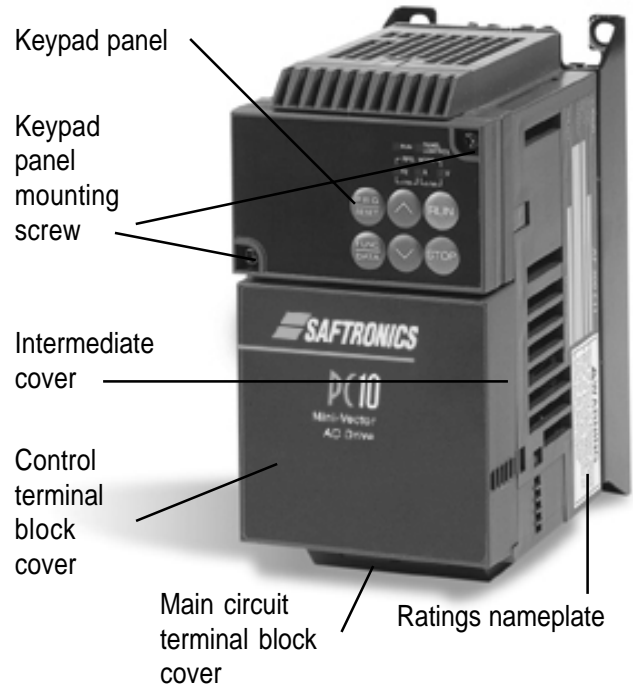

(1-2) Overall view (5.5,7.5 Hp)

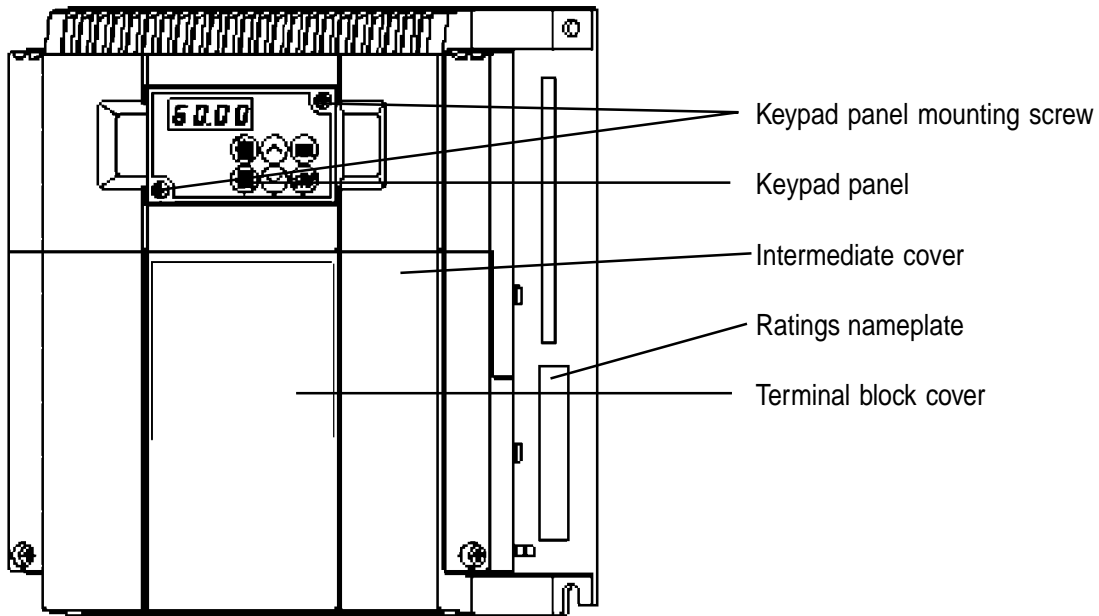

(2-1) View of wiring part (5 Hp or below)

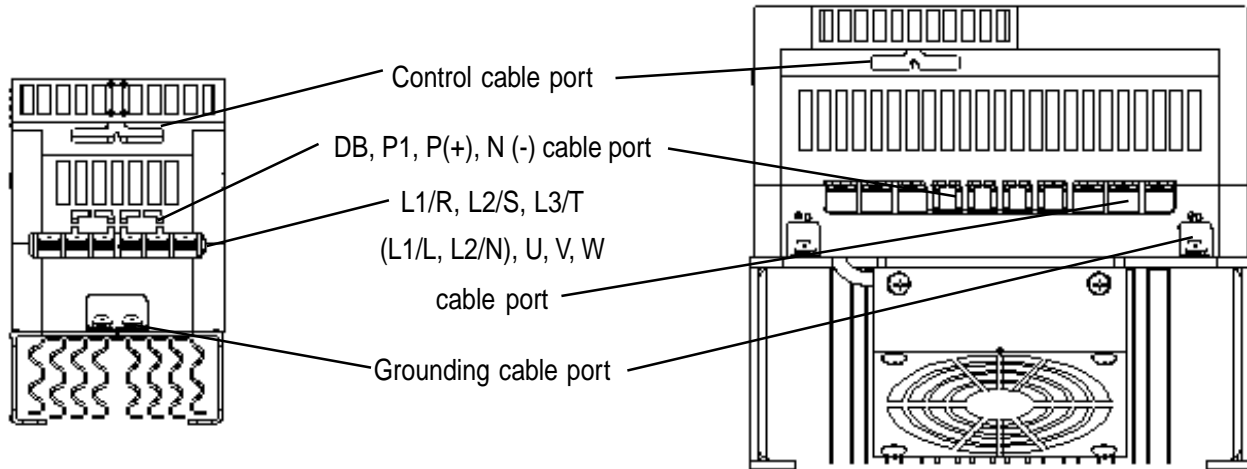

A barrier is provided in the cable cover for the P1, P(+), DB and N(-) cable port. Cut the barrier using nippers or the like before wiring.

(2-2) View of wiring part (7.5, 10 Hp)

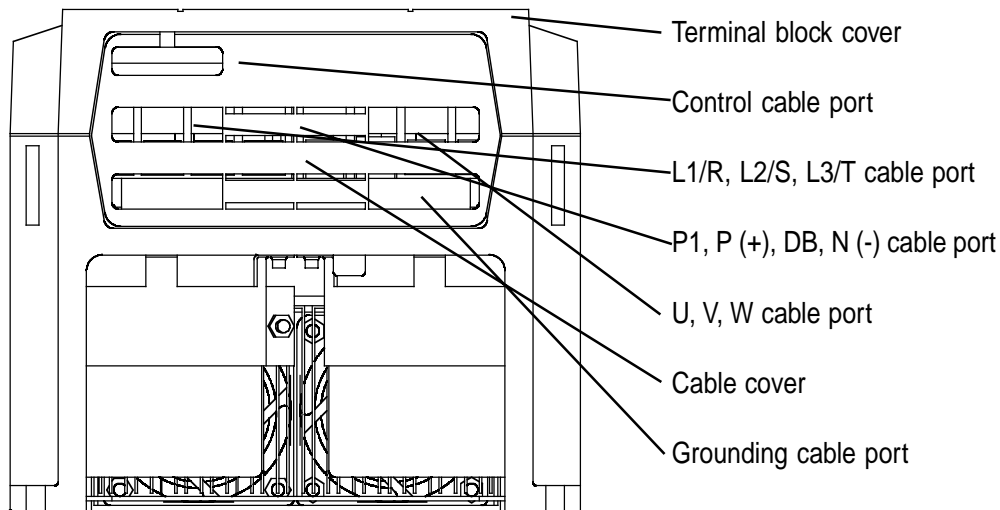

A barrier is provided in the cable cover for the P1, P (+), DB and N (-) cable port. Cut the barrier using nippers or the like before wiring.

1.3 Handling the Product

(1) Removing the control terminal block cover (5 Hp or below)

While lightly pushing in the sides of the control terminal block cover at the catches, lift the cover in the procedure shown in Fig. 1-3-1 to remove it.

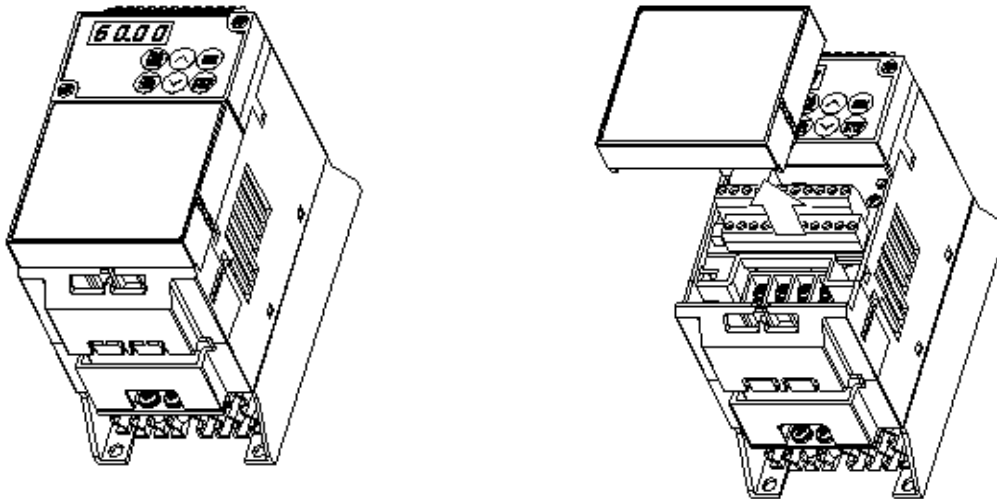

Fig. 1-3-1 Removing the control terminal block cover

(2) Removing the main circuit terminal block cover (5 Hp or below)

While lightly pushing in the sides of the main circuit terminal block cover at the catches, slide toward you in the procedure shown in Fig. 1-3-2 to remove it.

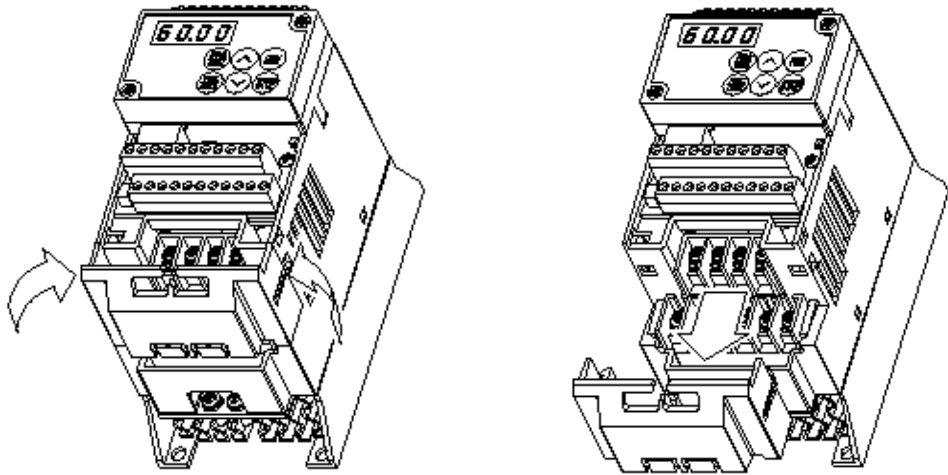

Fig. 1-3-2 Removing the main circuit terminal block cover

(3) Removing the terminal block cover (7.5, 10 Hp)

Loosen screws holding terminal block cover. While lightly pushing the sides of the terminal block cover at the catches, lift the cover in the procedure shown in Fig. 1-3-3 to remove it.

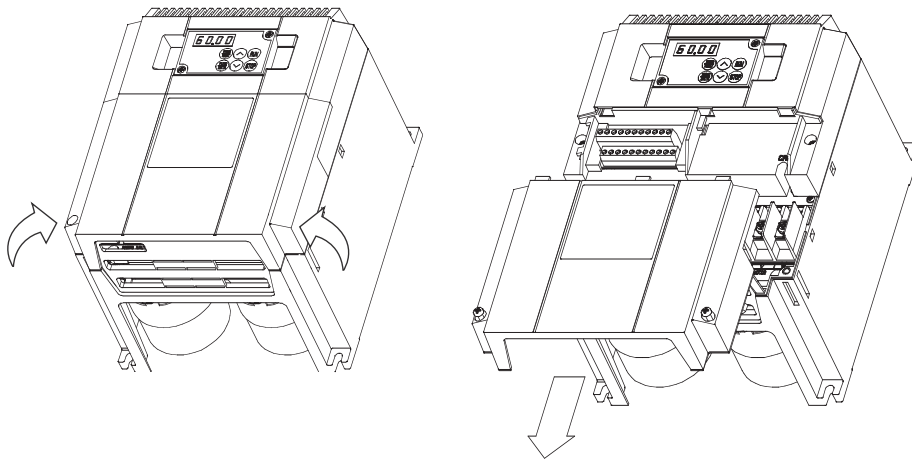

Fig. 1-3-3 Removing the terminal block cover

(4) Removing the keypad panel

Loosen the keypad panel mounting screws and remove the keypad panel in the procedure shown in Fig. 1-3-4. During the procedure, slowly remove the keypad panel from the unit. If the keypad panel is handled abruptly, the connector will be damaged.

Mounting screw (M3)

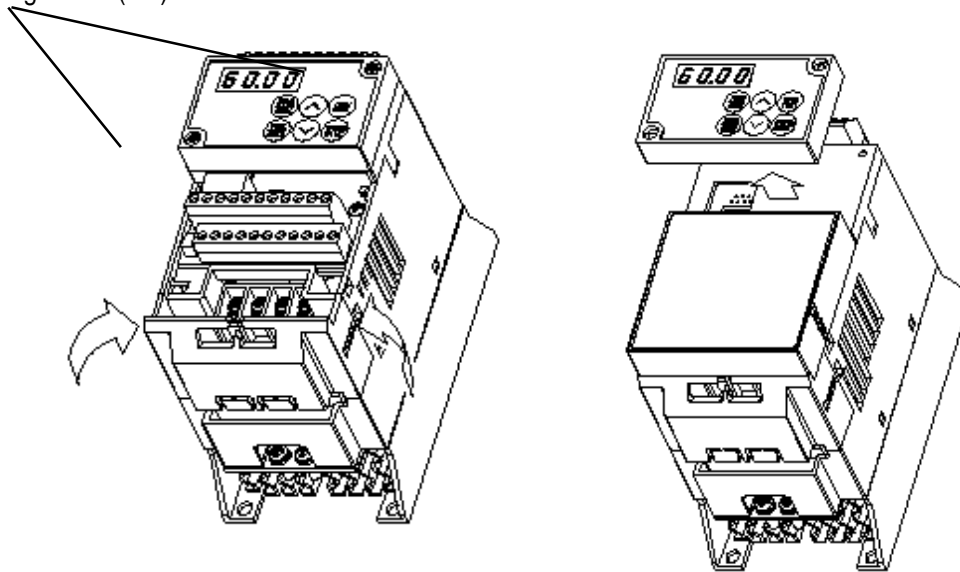

Fig. 1-3-4 Removing the keypad panel

Reverse the procedures to mount the terminal block cover and keypad panel.

1.4 Transportation

Always hold the main unit when carrying the drive.

If covers or parts are held, the drive may be broken or it may separate and drop.

1.5 Storage

To store temporarily:

Store the drive in an environment described in Table 1-5-1.

Item	Specifications
Ambient temperature	-10 to +50°C (+14 to +122°F)
Storage temperature ¹	-25 to +65°C (-4 to +149°F)
Relative humidity	5 to 95% ²
Atmosphere	The product must not be exposed to dust, direct sunlight, corrosive or flammable gases, oil mist, vapor, water drops or vibration. There must be little salt in the atmosphere.
Atmospheric pressure	86 to 106kPa (During storage)
	70 to 106kPa (During transportation)

Table 1-5-1 Storage environment

Note 1: The storage temperature is for a short time, such as transportation, etc.

Note 2: Even if the humidity is within the requirements of the specifications, places with abrupt temperature changes are subject to condensation or freezing. Avoid storing the drive in such places.

- (1) Do not place the drive directly on the floor.
- (2) If the ambient atmosphere is adverse, wrap the drive in a vinyl sheet or similar protection when storing.
- (3) If humidity may be present, add a drying agent (such as silica gel) in the package prepared as described in item (2).

To store for long periods.

The long-term storage method of the drive varies largely according to the environment of the storage site. General storage methods are described below.

- (1) The storage site must satisfy the requirements of specifications for temporary storage.
However, for storage exceeding three months, the upper limit of the ambient temperature shall not exceed 30 °C. This is to prevent deterioration of unpowered electrolytic capacitors.
- (2) The package must be air tight so that moisture will not enter. Add a drying agent inside the package to maintain a relative humidity inside the package of 70%.
- (3) A drive installed in a unit or control panel and stored is likely to be exposed to moisture and dust. If this is the case, remove the drive and move it to a preferable environment, as in item (1) or (2).
- (4) Electrolytic capacitors left unpowered for an extended period of time deteriorate. Do not store for more than one year without applying power to the drive.

PC10 Drive Ratings Efficiency and Watts Loss

HP Rating	Rated Output Current (A)	Rated Output Power (KVA)	Rated Output Rating (KW)	Efficiency at 0.75KHz (%)	Efficiency at 15KHz (%)	Watts Loss at 0.75KHz (W)	Watts Loss at 15KHz (W)
-----------	--------------------------	--------------------------	--------------------------	---------------------------	-------------------------	---------------------------	-------------------------

230VAC Three phase input

1/8	0.7	0.28	0.1	88.6	87.1	20	23
1/4	1.4	0.56	0.2	91.5	89.9	27	32
1/2	2.5	1.0	0.4	92.9	90.9	38	50
1	4	1.6	0.75	94.2	92.4	57	77
2	7	2.8	1.5	95.4	94.1	85	110
3	10	4.0	2.2	95.6	94.0	120	165
5	16.5	6.6	3.7	95.8	94.4	190	260
7.5	23.5	9.4	5.5	96.6	95.2	217	310
10	31	12.3	7.5	96.7	95.3	287	415

230VAC Single phase input

1/8	0.7	0.28	0.1	88.1	86.6	21	24
1/4	1.4	0.56	0.2	91.0	89.5	28	34
1/2	2.5	1.0	0.4	92.7	90.7	40	51
1	4	1.6	0.75	93.9	92.1	61	80
2	7	2.8	1.5	94.8	93.2	96	129
3	10	4.0	2.2	95.0	93.5	135	180

460VAC Three phase input

0.5	1.4	1.1	0.4	95.1	91.8	26	45
1	2.1	1.7	0.75	96.3	93.6	36	64
2	3.7	2.9	1.5	97.0	94.5	55	103
3	5.3	4.2	2.2	97.1	94.6	78	149
5	8.7	6.9	3.7	97.4	94.9	116	235
7.5	12	9.6	5.5	97.8	95.5	137	289
10	16	12.7	7.5	97.8	95.5	189	389

2. Installation and Connection

2.1 Operating Environment

Install the drive in an environment as described in Table 2-1-1.

Table 2-1-1 Operating environment

Item	Specifications
Site	Indoors
Ambient temperature	-10 to +50 °C (+14 to 122°F)
Relative humidity	5 to 95% (without condensation)
Atmosphere	The inverter must not be exposed to dust, direct sunlight, corrosive gases, oil mist, vapor or water drops. There must be little salt. No condensation occurs due to abrupt temperature changes.
Altitude	3,300 ft. (1,000 m) max. [Refer to Table 2-1-2 for altitudes exceeding 3,300 ft. (1000 m.)]
Atmospheric pressure	86 to 106 kPa
Vibration	3mm 2 to 9 Hz 9.8m/s ² 9 to 20 Hz 2m/s ² 20 to 55 Hz 1m/s ² 55 to 200 Hz

Table 2-1-2 Output attenuation ratio in relation to altitude

Altitude	Output current attenuation ratio
3300 ft. (1000-1500m)	1.00
3300-4950 ft. (1000-1500m)	0.97
4950-6600 ft. (1500-2000m)	0.95
6600-8250 ft. (2000-2500m)	0.91
8250-9900 ft. (2500-3000m)	0.88

2.2 Installation Method

- (1) Securely mount the drive in the upright position on a rigid structure so that the PC10 characters face front. Avoid mounting the drive upside down or horizontally.
- (2) Allow clearances for cooling as shown in Fig. 2-2-1. This allows the drive, which generates heat during operation, to cool. The generated heat is radiated upward. Do not install the drive below a heat sensitive device.
- (3) The temperature of the heat sink rises to about 90 degrees C during operation of the drive. Mount the drive on a base made of a material able to withstand the temperature rise.

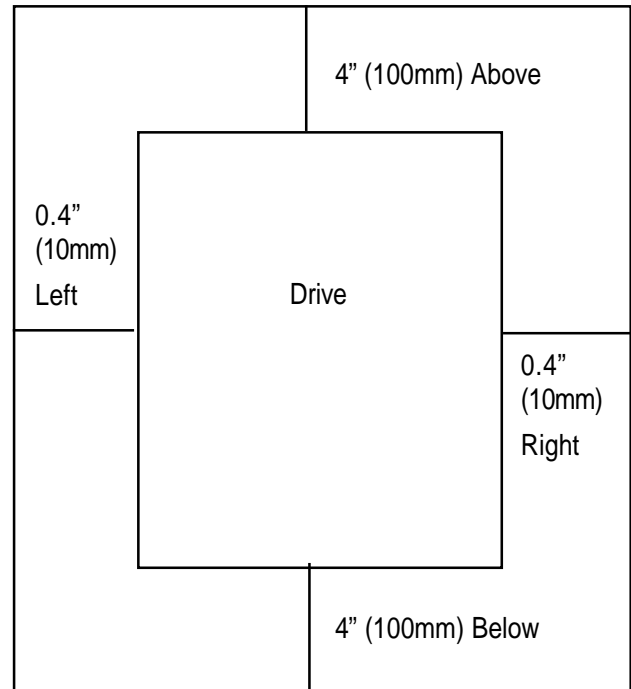

Figure 2-2-1

DANGER

Install the drive on a nonflammable material such as metal. **Otherwise fire could occur.**

- (4) When installing the drive inside a control panel, take into consideration ventilation so that the ambient temperature of the drive does not exceed the specification requirements. Do not install the drive in a poorly ventilated, undersized enclosure.
- (5) When installing multiple drives inside a control panel, horizontal installation is recommended to reduce mutual temperature effects. When a vertical layout is necessary, install a partition plate or the like between drives to isolate the heat of the lower drive.

CAUTION

Do not allow lint, paper, wood chips, dust, metallic chips or other foreign matter in the drive. Do not allow them attached to the heat sink. **A fire or an accident may result.**

2.3 Connection

Remove the control terminal block cover to connect to the control terminal block. Remove the main circuit terminal block cover to connect to the main circuit terminal block. Connect cables using the following precautions.

2-3-1 Basic Connection

- (1) Be sure to connect the power cables to main circuit power terminals L1/R, L2/S and L3/T of the drive. If the power cables are connected to other terminals, the drive will be damaged. Check the source voltage for the allowable voltage range specified on the nameplate.
- (2) Connect the grounding terminal according to national or local electric code to prevent electric shock, fire or other disasters and to reduce electric noise. Ground must be connected.
- (3) Use reliable crimp terminals for connection of cables to the terminals.
- (4) After wiring, check the following:
 - a. Check that the cables are connected to the correct terminals.
 - b. Check that there are no bad crimps or connections.
 - c. Check that terminals or cables are not short circuited and there is no ground fault.
- (5) To change connection of an drive having been turned on, observe the following:

The smoothing capacitor in the direct current part of the main circuit takes time to be discharged after it is turned off. To avoid danger, check the DC voltage (across main circuit terminals P (+) and N (-)) for a safe voltage (25 Vdc or lower) using a multi-meter, after the charge lamp is off. Wait until the residual voltage is discharged before shorting a circuit, to avoid being hit by sparks caused by the voltage (electric charge).

DANGER

- Be sure to connect the grounding cable.
Otherwise, electric shock or fire could occur.
- Qualified electricians should carry out wiring.
Otherwise, electric shock could occur.
- Perform wiring after checking that the power supply is turned off.
Otherwise, electric shock could occur.

Basic connection diagram

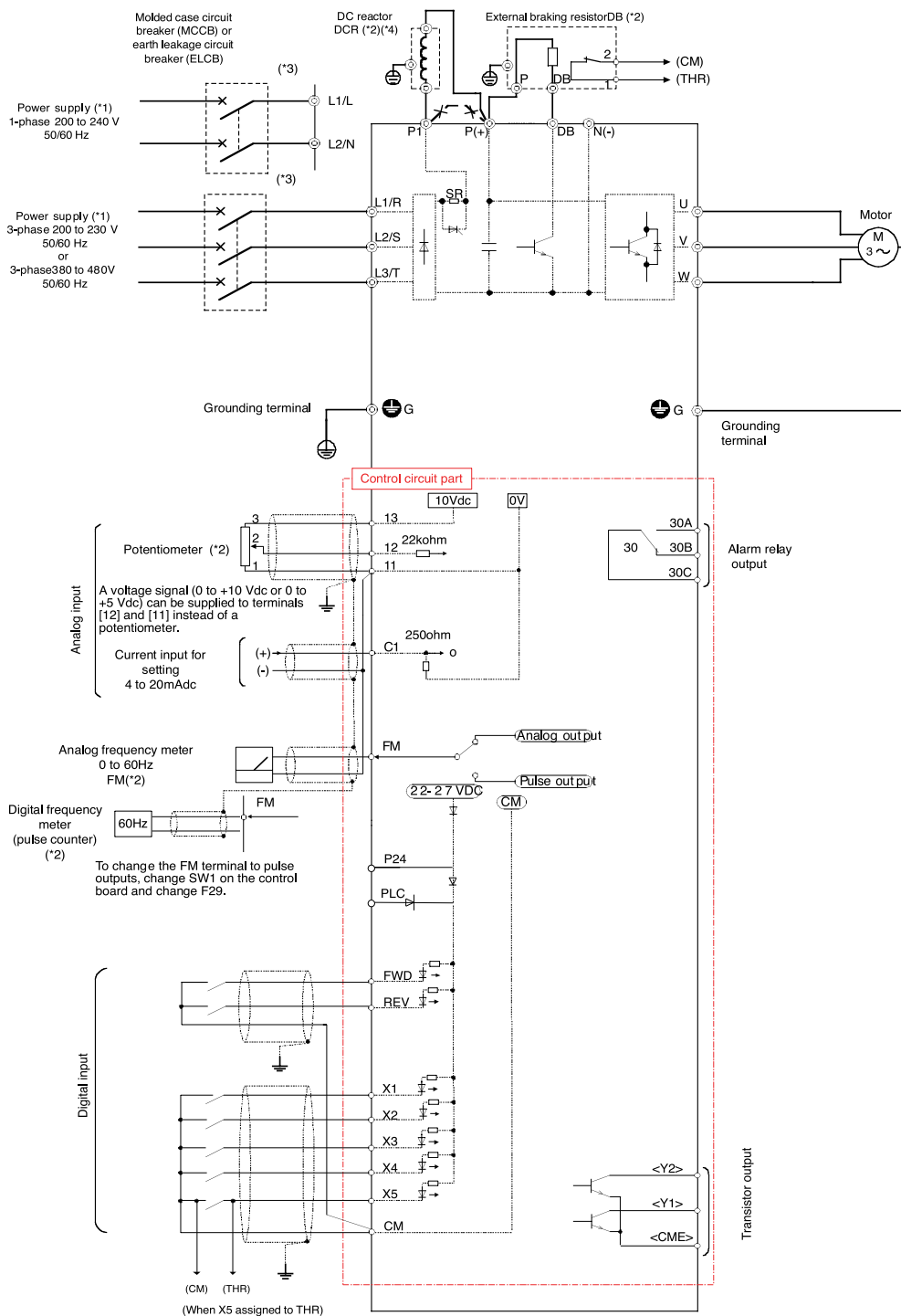

- *1) Source voltage must be suitable for the rated voltage of the drive.
- *2) Optional part. Use when necessary.
- *3) Peripheral equipment. Use when necessary.
- *4) To connect a DC reactor (DCR) for power factor correcting, remove the jumper between the P1 and P (+) terminals.

2-3-2 Connection of Main Circuit and Grounding Terminal.

Symbol	Name of terminal	Description
L1/R,L2/S,L3/T	Main circuit power input	Connects a 3-phase power supply.
L1/L,L2/N	Main circuit power input	Connects a 1-phase power supply.
U,V,W	Drive output	Connects a 3-phase induction motor.
P1,P(+)	For DC reactor	Connects an optional DC reactor.
P(+),DB	For external braking resistor	Connects an optional external braking resistor.
P(+),N(-)	DC link circuit terminal	Connected to DC link circuit.
G	grounding	Grounding terminal of the drive chassis (housing). Connect to the protective ground.

(1) Main circuit power terminals (L1/R, L2/S, L3/T)

- Connect these terminals to the power supply via a molded-case circuit breaker or ground-leakage circuit breaker for circuit protection. Phase-sequence matching is unnecessary.
- To insure safety, a magnetic contactor should be used to disconnect the drive from the power supply when the drive protective function activates.
- Use control circuit terminal FWD/REV or the RUN/STOP key on the keypad panel to start or stop the drive. The main circuit power should be used to start or stop the drive only if absolutely necessary and then should not be used more than once every hour.
- If you need to connect these terminals to a single-phase power supply, please contact the factory.

(2) Drive output terminals (U, V, W)

- Connect these terminals to a 3-phase motor in the correct phase sequence. If the direction of motor rotation is incorrect, exchange any two of the U, V, and W phases.
- Do not connect a power factor correction capacitor or surge absorber to the drive output.
- If the cable from the drive to the motor is very long, a high-frequency current may be generated by stray capacitance between the cables and result in an overcurrent trip of the drive, an increase in leakage current, or a reduction in current indication precision.

When a motor is driven by a PWM-type drive, the motor terminals and windings may be subject to surge voltage generated by drive element switching. If the motor cable (with 460V series motors, in particular) is particularly long, surge voltage will deteriorate motor insulation. To prevent this from occurring, use the following guidelines:

Drives 7.5 HP and larger

Motor Insulation Level	1000V	1300V	1600V
460 VAC Input Voltage	66 ft (20 m)	328 ft (100 m)	1312 ft (400 m) *
230 VAC Input Voltage	1312 ft (400 m) *	1312 ft (400 m) *	1312 ft (400 m) *

Drives 5 HP and smaller

Motor Insulation Level	1000V	1300V	1600V
460 VAC Input Voltage	66 ft (20 m)	165 ft (50 m) *	165 ft (50 m) *
230 VAC Input Voltage	328 ft (100 m) *	328 ft (100 m) *	328 ft (100 m) *

* For this case the cable length is determined by secondary effects and not voltage spiking.

Note: When a motor protective thermal O/L relay is inserted between the drive and the motor, the thermal O/L relay may malfunction (particularly in the 460V series), even when the cable length is 165 feet (50m) or less. To correct, insert a filter or reduce the carrier frequency. (Use function code "F26 Motor sound".)

(3) DC reactor connecting terminals (P1, P (+))

- a. Use this terminal to connect a DC reactor (option).
Remove the jumper connected at the factory before connecting the DC reactor.
 - b. Do not remove the jumper if no DC reactor is used.
- Cut the barrier in the main circuit terminal block cover for the P1, P (+), DB and N (-) cable port using nippers or the like when connecting wiring.

CAUTION

DC reactor does not come with drive. However use the DC reactor or AC reactor under the conditions listed below.

1. Used when the capacity of the power supply transformer exceeds 500k VA and exceeds 10 times the rated capacity of the drive.
2. Used when a thyristor converter is a common load on the same transformer. If the communicating reactor is not used for the thyristor converter, an AC reactor is necessary at the drive input side. Confirm.
3. Used to prevent a drive OV trip from occurring when the phase advance capacitor in the power line is switched on and off.
4. Used when the voltage imbalance exceeds 3%

Imbalance rate between phases [%] =

$$\frac{(\text{Max. voltage [V]} - \text{Min voltage [V]})}{\text{3-phase average voltage [V]}} = 100\%$$

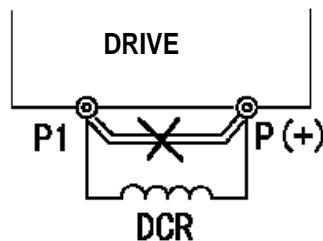

(4) External braking resistor connecting terminals (P (+), DB)

PC10 is not equipped with a braking resistor. An external braking resistor (option) is necessary for frequent operation or heavy duty inertia load operation to enhance the braking performance.

- a. Connect the P (+) and DB terminals of the external braking resistor to the P (+) and DB terminals of the drive.
- b. Arrange devices so that the wiring length is within 16.5 ft. (5m) and the cable is twisted or tied in parallel.

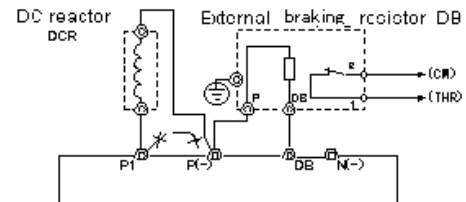

(5) Drive grounding terminal (G)

Ground the grounding terminal G for safety and noise reduction. The metallic frame of electrical equipment must be grounded in accordance with national or local electric code to avoid electric shock, fire and other disasters.

CAUTION

- Check that the number of phases and the rated voltage of the product agrees with the number of phases and the voltage of the AC power supply.
- Do not connect the AC power cables to the output terminals (U, V, W). Otherwise injuries could occur.
- Do not connect a braking resistor directly to the DC terminals (P (+), N (-)). Otherwise fire could occur.

2-3-3 Connection of Control Terminal

Table 2-3-2 shows the functions of the control circuit terminals. The method of connecting control function terminals varies according to the function setting. Refer to the connection method for the function.

Table 2-3-2 Functions of control circuit terminals

Classification	Terminal symbol	Terminal name	Description of function																								
Analog Input	13	Potentiometer power supply	+10 Vdc power supply for frequency setting POT. G1 (POT: 1 to 5 kohm)																								
	12	Voltage input	(1) The frequency is set according to the external analog input voltage command. 0 to +10 Vdc / 0 to 100% Reversible operation using +/- signal: 0 to +/-10 Vdc / 0 to 100% Inverse mode operation: +10 to 0 Vdc / 0 to 100% (2) The PID control feedback signal input. * Input resistance: 22 kohm																								
	C1	Current input	(1) The frequency is set according to the analog input current command. 4 to 20 mAdc / 0 to 100% Inverse mode operation: 20 to 4 mAdc / 0 to 100% (2) The PID control feedback signal input. * Input resistance 250 ohm																								
	11	Common	Common for analog signals																								
Digital Input	FWD	Forward operation command	Forward operation with FWD-CM ON and deceleration and stop with FWD-CM OFF																								
	REV	Reverse operation command	Reverse operation with REV-CM ON and deceleration-stop with REV-CM OFF																								
	X1	Digital input 1	A coast-to-stop command from an external device, external alarm, alarm reset, multi-step frequency selection and other functions can be assigned to the X1 through X5 terminals. Refer to the terminal function E01 to 05 setting method in section 5-2, Detail Description of Each Function.																								
	X2	Digital input 2																									
	X3	Digital input 3																									
	X4	Digital input 4																									
	X5	Digital input 5																									
			<Digital input circuit specification>																								
			<table border="1"> <thead> <tr> <th colspan="2">Item</th> <th>min</th> <th>type</th> <th>max</th> </tr> </thead> <tbody> <tr> <td rowspan="2">Operation voltage</td> <td>Level ON</td> <td>0V</td> <td>—</td> <td>2V</td> </tr> <tr> <td>Level OFF</td> <td>22V</td> <td>24V</td> <td>27V</td> </tr> <tr> <td colspan="2">Operation current at ON</td> <td>—</td> <td>4.2mA</td> <td>6mA</td> </tr> <tr> <td colspan="2">Allowable leakage current at OFF</td> <td>—</td> <td>—</td> <td>0.5mA</td> </tr> </tbody> </table>	Item		min	type	max	Operation voltage	Level ON	0V	—	2V	Level OFF	22V	24V	27V	Operation current at ON		—	4.2mA	6mA	Allowable leakage current at OFF		—	—	0.5mA
	Item		min	type	max																						
	Operation voltage	Level ON	0V	—	2V																						
Level OFF		22V	24V	27V																							
Operation current at ON		—	4.2mA	6mA																							
Allowable leakage current at OFF		—	—	0.5mA																							
PLC	PLC terminal	The output signal power supply of the PLC is connected. (Rated voltage: 24 Vdc)																									
CM	Common	Common for digital input																									

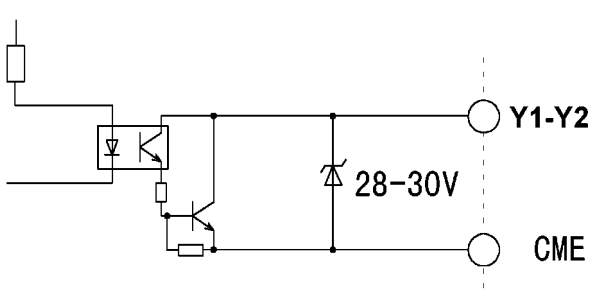
Classification	Terminal symbol	Terminal name	Description of function																								
Analog output/Pulse output	FM (11: Common terminal)	Analog monitor	<p>The monitored signal is output as 0 to 10 VDC. The signal can be selected from the following:</p> <ul style="list-style-type: none"> Output frequency1 (before slip compensation) Output frequency2 (after slip compensation) Output current Output torque Input power DC link circuit voltage Output voltage Load factor PID feedback value <p>* Allowable connection impedance: min. 5 k ohm</p>																								
		Pulse rate monitor	<p>The monitored signal is output according to the pulse voltage. The signal description is the same as the FMA signal. * Allowable connection impedance: min. 5 k ohm. Use SW1 on the control board and function code F29 to change between the analog monitor and Pulse rate monitor. (FMA: analog monitor, FMP: Pulse rate monitor).</p>																								
Transistor output	Y1	Transistor output 1	<p>The RUN signal, frequency equivalence signal, overload early warning signal and other signals are output to a transistor output. Refer to terminal function E20 to 21 setting methods in section 5-2, Detail Description of Each Function.</p> <p><Transistor output circuit specification></p> <table border="1"> <thead> <tr> <th colspan="2">Item</th> <th>min</th> <th>type</th> <th>max</th> </tr> </thead> <tbody> <tr> <td rowspan="2">Operation voltage</td> <td>Level ON</td> <td>—</td> <td>1V</td> <td>2V</td> </tr> <tr> <td>Level OFF</td> <td>—</td> <td>24V</td> <td>27V</td> </tr> <tr> <td colspan="2">Maximum load current at ON</td> <td>—</td> <td>—</td> <td>50mA</td> </tr> <tr> <td colspan="2">Leakage current at OFF</td> <td>—</td> <td>—</td> <td>0.1mA</td> </tr> </tbody> </table> 	Item		min	type	max	Operation voltage	Level ON	—	1V	2V	Level OFF	—	24V	27V	Maximum load current at ON		—	—	50mA	Leakage current at OFF		—	—	0.1mA
	Item			min	type	max																					
	Operation voltage	Level ON		—	1V	2V																					
		Level OFF		—	24V	27V																					
Maximum load current at ON		—	—	50mA																							
Leakage current at OFF		—	—	0.1mA																							
Y2	Transistor output 2																										
CME	Common (Transistor output)	Common for transistor output signal. Isolated from terminals CM and 11.																									
P24 (CM: common terminal)	DC voltage supply	Power supply for transistor output load. (24 Vdc 50 mAdc Max.) (When using P24, short the CM and CME terminals.) (If the P24 terminal is overloaded or connected with the CM terminal, the drive trips with Er3 indication. To reset, remove external causes and, after several minutes, turn the drive on again.)																									
Relay output	30A,30B, 30C	Alarm relay output	<p>When the drive is stopped with an alarm, a relay contact output (1C) is issued.</p> <p>Contact capacity: 250 Vac 0.3 A cos = 0.3 (When complying with low voltage directive: 48 Vdc 0.5 A When complying UL/cUL: 42Vdc 0.5A)</p> <p>Selection between excitation upon an alarm or excitation during normal operation is allowed.</p>																								

(1) Analog input terminals (13, 12, C1, 11)

- a. Because weak analog signals are handled, these signals are especially susceptible to the external noise effects. Route the wiring as short as possible (within 20 m) and use shielded cables. In principle, ground the shield of the shielded cable; if effects of external inductive noises are considerable, connection to terminal 11 may be effective.
- b. Use twin contact relay for weak signals if relay is used in the circuit. Do not add a contact to terminal 11.
- c. When the drive is connected to an external device outputting the analog signal, a malfunction may be caused by electric noise generated by the drive according to the circuit connection of the connected device. If this happens, connect a ferrite core or capacitor to the device outputting the analog signal.

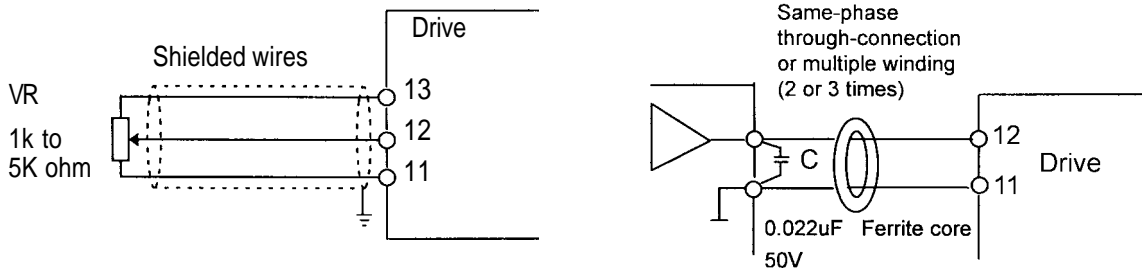

(2) Digital input terminals (FWD, REV, X1 through X5, PLC, CM)

- a. Generally the digital input terminals (FWD, REV, X1-5) are turned on or off in relation to the CM terminal. When the terminals are turned on or off at the open collector output using an external power supply, malfunctions may be caused due to a routing circuit. If this happens, use the PLC terminal as shown in Fig. 2-3-11.
- b. To use contact input, use a reliable contact, free from corrosion and debris.

(3) Transistor output terminals (Y1-Y2, CME)

- a. Circuit configuration shown in Table 2-3-2 for transistor output is used. Note the polarity of the external power supply.
- b. To connect a control relay, connect a surge absorbing diode across the coil of the relay.

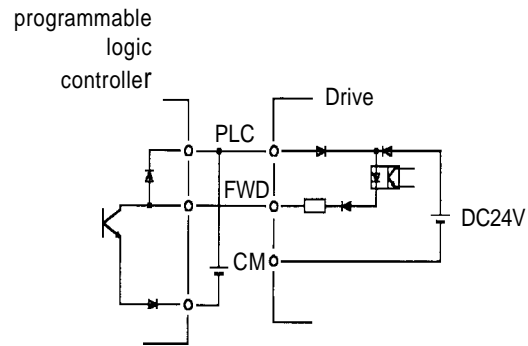

(4) Others

- a. Route the wiring of the control terminals as far from the wiring of the main circuit as possible. Otherwise electric noise may cause malfunctions.
- b. Fix the control cables inside the drive to keep them away from the live parts of the main circuit (such as the terminal block of the main circuit).

DANGER

If the control cables touch the live part of the main circuit, the insulation sheath of the control cable, may be damaged and cause the high voltage of the main circuit to be fed to the control signal. This is not permissible in the low voltage directive models for Europe. **Electric shock could occur.**

CAUTION

Electric noise may be generated by the drive, motor or wiring. Note the possible malfunctions of nearby sensors and devices due to noise. **An accident could occur.**

2.3.4 Terminal Layout

(1) Main circuit terminal block

Type of drive
 PC10E1ST32F12 **
 PC10E1ST32F25 **
 PC10E1ST32F50 **
 PC10E1ST32001 **
 PC10E1ST12F12 **
 PC10E1ST12F25 **
 PC10E1ST12F50 **

Main circuit terminal drawing

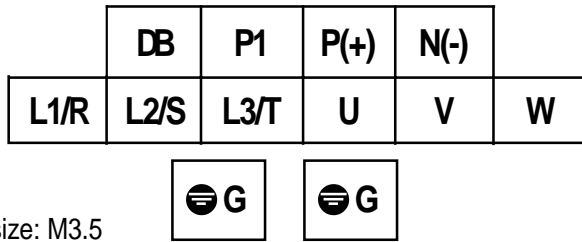

Screw size: M3.5

Note: Single-phase input has L1/L, L2/N for input power.

PC10E1ST32002 **
 PC10E1ST32003 **
 PC10E1ST12001 **
 PC10E1ST34F50 **
 PC10E1ST34001 **
 PC10E1ST34002 **
 PC10E1ST34003 **

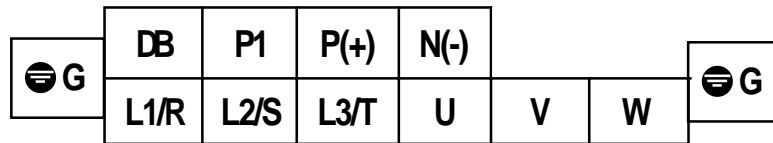

Screw size: M4

Note: Single-phase input has L1/L, L2/N for input power.

PC10E1ST32005 **
 PC10E1ST32007 **
 PC10E1ST32010 **
 PC10E1ST12002 **
 PC10E1ST12003 **
 PC10E1ST34005 **
 PC10E1ST34007 **
 PC10E1ST34010 **

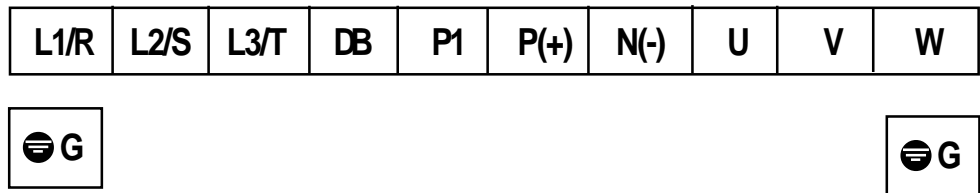

Screw size: M4

Note: Single-phase input has L1/L, L2/N for input power.

**Indicates product revision

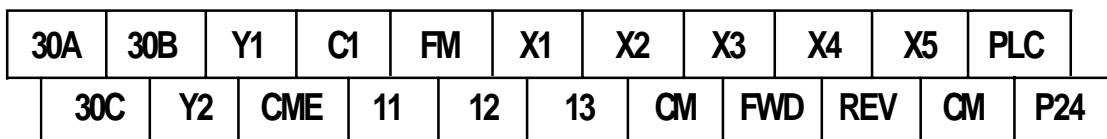

(2) Control terminal block

Screw size: M2.5

Tightening torque: 3.5 lb•Inch (0.4 N•m)

Note: Refer page v for cable size, tightening torque and incoming device rating.

3. Operation

3.1 Inspection and Preparation Before Operation

Check the following before starting operation.

- (1) Check if all power and control connections are correct.
Especially check if the motor power cables are connected to drive output terminals U, V and W and that the grounding cable must be grounded without fail. (Note the drive and operation can be checked prior to connecting the motor).
- (2) Check for short circuits between terminals and exposed live parts and ground faults.
- (3) Check for loose terminals, connectors and screws.
- (4) Check if the motor is separated from mechanical equipment.
- (5) Turn the switches off so that the drive does not start or operate at power-on.
- (6) After the power is turned on, check the following.
 - a. Check if the keypad panel shows an alarm.
 - b. Check if the fan built in the drive rotates. (2 Hp or above)

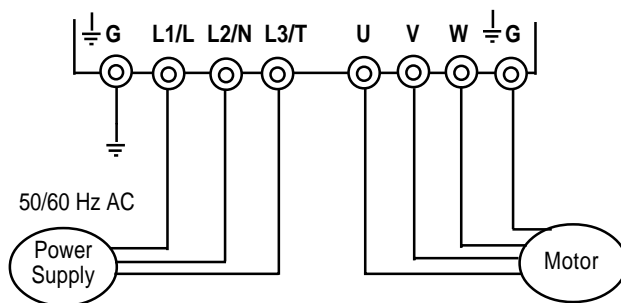

Fig. 3-1-1

Drive connection diagram

DANGER







- Be sure to install the terminal cover before turning the power on. Do not remove the cover during power application.
- Do not operate switches with wet hands.
Otherwise electric shock could occur.

Note: AC power supply cannot be connected to connection points U, V and W.

3.2 Operation Method

There are various operation methods. Refer to chapter 4 “Keypad Panel” and chapter 5 “Selecting Functions” to select the method most suitable for the application and operation specification. Table 3-2-1 shows general operation methods.



Table 3-2-1 General operation methods

Operation method	Frequency setting	Operation command
Operation using keypad panel	Keypad panel keys  	Keypad panel keys  
Operation using external signal terminal	  Potentiometer or analog voltage, current or multistep speed operation	Contact input (switch), terminals FWD-CM, terminals REV-CM

3.3 Test Operation

After checking for errors in section 3-1, perform a test operation.

In the factory shipment state, the drive is in the keypad panel operation mode.

- (1) Turn the power on and check that the LED blinks while indicating the 0.00 Hz frequency.
- (2) Using the  key, set the frequency to a low frequency such as 5 Hz.
- (3) Press the  key to start operation. To stop, press the  key.
- (4) Check the following points.
 - a. Check if the direction of rotation is correct.
 - b. Check for smooth rotation without motor humming or excessive vibration.
 - c. Check for smooth acceleration and deceleration.
- (5) Referring to function code P04 Motor 1 (auto tuning), tune the motor constant.

When no abnormality is found, raise the operation frequency to check for full speed range operation.

After checking for correct operation during the above test operation, start normal operation.

Caution 1:

If any abnormality is found to the drive or motor, immediately stop operation and determine the cause referring to chapter 7 Troubleshooting.

Caution 2:

If voltage is applied to the L1/R, L2/S and L3/T main circuit power supply terminals, even after the drive stops, the drive output terminals U, V and W will have a voltage present and you will be hit by electric shock when touching the terminals. As well, the smoothing capacity does not discharged immediately after the power is turned off, and it takes time for the capacitor to be discharged and a voltage is present.

Before touching the electric circuit, after turning the power off, check that the charge lamp is unlit and check for safe voltage using a multimeter checking the various power circuit connections.

4. Keypad Panel

The keypad panel is provided with various functions such as operation (frequency setting and start/stop commands) from the keypad panel, monitor and alteration of function code data, and various confirmation functions.

Be familiar with the operation method of each function before starting operation.

4.1 Appearance of Keypad Panel

Digital display

Various function codes and data codes for programming are shown. The output frequency, output current and other data are displayed during operation, and the cause of a trouble is displayed using codes when protective function works.

Unit and operation mode display

The unit of the data displayed at the digital display is indicated with an LED. The program mode is indicated. The PANEL CONTROL lamp lights up in the keypad panel operation mode.



RUN key

Press this key to start operation. An LED lights up during operation. When data code F__0 2 = ____ 1, the key does not function.

STOP key

Press this key to stop operation. When data code F__0 2 = ____ 1, the key does not function.

UP/DOWN keys

Press these keys to increase or decrease the frequency or speed. In the programming mode, use these keys to change the function code or data setting.

Function (FUNC)/DATA key

Use this key to switch over between frequency display, output current display and other display in the regular operation mode. In the programming mode, use this key to retrieve or write various function codes and various data codes.

Program (PRG)/RESET key

Press this key to switch over between the regular operation mode and programming mode. Use this key to reset an alarm stopping state after activation of a protective function.

(1) Monitor switching method

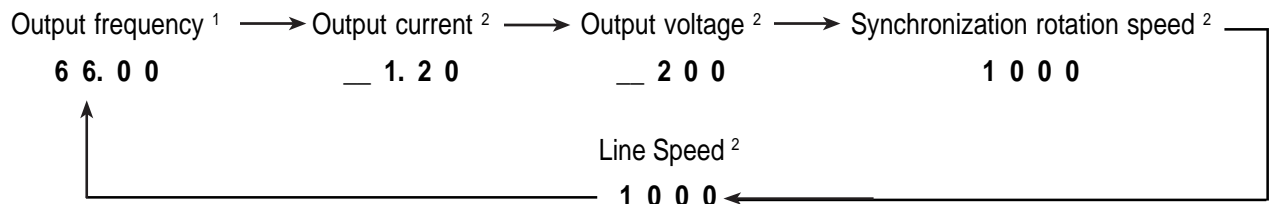

In the regular operation mode, press the **FUNC/DATA** key to switch between frequency display, output current display and other display.

1: In the PID control mode (when function H20 is at "1" or "2"), the value is in the percent display and the dot at the least significant digit always lights up.

Example: 10%: __ 1 0 . 0 . , 100%: 1 0 0 . 0 .

2: Press the **UP**, **DOWN** key during display of these data to display the frequency setting.

Note: __ shows blank space.

(2) Stopping operation

Operation is started when the **RUN** is pressed, and is stopped when the **STOP** is pressed while function **F — 0 2** is set to — — — 0, — — — 1 or — — — 3 press.

The direction rotation is Forward rotation with FWD-CM ON and reverse rotation with REV-CM ON

(3) Changing the frequency

The frequency increases when the **▲** key is pressed and decreases when the **▼** key is pressed while function **F — 0 1** is set to — — — 0

The change speed is increased when the **FUNC DATA** key is pressed at the same time as the **▲** or **▼**

Note: Do not turn the power off for five seconds after performing a monitor change or function setting; otherwise Er1 will result.

(4)Function setting method

Description of operation	Operation procedure	Display result
Initial condition		6 0. 0 0
Start the program mode.	Press the PRG RESET key.	F — 0 0
Select a setting or monitoring function.	Press the ▲ or ▼ key.	F — 0 1
Have the data displayed.	Press the FUNC DATA key.	— — — 1
Change the data.	Press the ▲ or ▼ key.	— — — 2
Store the data.	Press the FUNC DATA key.	F — 0 2
Exit from the program mode. (Or select another function.)	Press the PRG RESET (Press the ▲ or ▼ key)	6 0. 0 0

Note: ___ shows blank space.







(5) Changing the function code

The function code consists of an alphabetic character and a numerical. The alphabetic character is defined for each of the function groups.

Table 4-1-1 Major groups of function codes

Function code	Function
F00 - F42	Fundamental functions
E01 - E41	Extension terminal functions
C01 - C33	Control functions of frequency
P01 - P10	Motor parameters
H01 - H46	High performance functions
A01 - A19	Alternative motor parameters

The function code changes each time the  or  key is pressed. (Press and hold the  or  key to continue changing the function code.)

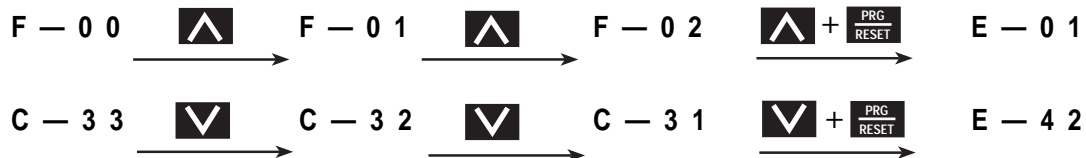

While pressing and holding the  or  key during function code change, press the  key to change to the next group with another alphabetic character. (Press the  and  keys to jump to the top of the F, E, C, P, H or A code, or press the  and  key to jump to the last of the F, E, C, P, H or A code.)

Changing example:







4-1-1 Upon an Alarm

When an alarm occurs, the description of the alarm is displayed.

Press the  or  key during alarm display to display the latest three alarms.

To display previous 4 alarms, select function (Refer to H02 Trip history.)

4-1-2 Digital Frequency Setting Method

Press the  or  key with the operation mode screen selected; the LED displays changes made to the frequency setting. The displayed data increases or decreases with the unit of the least increment first. While the  or  key is held down, the changing digit moves to the upper order for easy increased rate of change.

Further, while pressing and holding down the  or  key, by pressing the  key will increase the rate of speed change further.

No special operation is necessary to store the new frequency setting. The setting is automatically stored when the drive is turned off.

5. Selecting Functions

5.1 Function Selection List

F: Fundamental functions						
Function Code	Name	Setting Range	Min. Unit	Factory Setting	Change during operation	User Setting
F00	Data protection	0: Data change enabled 1: Data protected	1	0	N	
F01	Frequency command 1	0: Key 1: Voltage input (terminal 12) 2: Current input (terminal C1) 3: Voltage and current input 4: Voltage input with polarity 5: Voltage input inverse mode operation (terminal 12) 6: Current input inverse mode operation (terminal C1) 7: UP/DOWN control mode 8: UP/DOWN control mode	1	0	N	
F02	Operation method	0: Keypad operation 1: Terminal operation (stop key active) 2: Terminal operation (stop key inactive) 3: Terminal operation (stop key active with Comm software) 0: Terminal operation (stop key inactive with Comm software)	1	0	N	
F03	Maximum frequency	50 to 400 Hz	1 Hz	60	N	
F04	Base frequency	25 to 400 Hz	1 Hz	60	N	
F05	Rated voltage 1 (at Base frequency)	0V: Output voltage is proportional to the source voltage 80 to 240V (230V class) 160 to 480V (460V class)	1V	230 460	N	
F06	Maximum voltage 1 (at Maximum frequency)	80 to 240V (230V class) 160 to 480V (460V class)	1V	230 460	N	
F07	Acceleration time 1	0.01 to 3600s	0.01s	6.00	Y	
F08	Deceleration time 1	0.01 to 3600s	0.01s	6.00	Y	
F09	Torque boost1	0: Automatic torque boost 1: Variable speed (fans/pumps) torque characteristics 2: Proportional torque characteristics 3 to 31: Constant torque characteristics	1		Y	
F10	Electronic thermal overload relay for motor 1 (Select)	0: Inactive 1: Active (for general purpose motors) 2: Active (for forced air extended operating range motors)	1	1	Y*	
F11	(level)	20 to 135% of the rated inverter current	0.01A	rated motor current	Y	
F12	(Thermal time constant)	0.5 to 10.0 min.	0.1 min	5.0	Y	
F13	Electronic thermal overload relay (for braking resistor)	0: In active 1: Active (for external braking resistor up to 5 Hp) 2: Active (for external braking resistor 7.5 / 10 Hp)	1	0	N	
F14	Restart mode after momentary power failure	0: Inactive (The drive immediately trip) 1: Inactive (The drive trips after the power failure is recovered) 2: Active (The drive restarts at the frequency prior to power failure) 3: Active (The drive restarts at the starting frequency)	1	0	N	
F15	Frequency (high)	0 to 400 Hz	1 Hz	70	Y	
F16	Frequency (low)			0	Y	
F17	Gain (For frequency)	0.0 to 200.0%	0.10%	100	Y	
F18	Bias frequency	-400 to +400 Hz	1 Hz	0	Y	
F20	DC Brake (Starting frequency)	0.0 to 60.0 Hz	0.1 Hz	0.0	Y	
F21	(Braking Level)	0 to 100%	1%	0	Y	
F22	(Braking time)	0.0s (Inactive) 0.1 to 30.0s	0.1s	0.0	Y	
F23	Starting frequency (Freq)	0.1 to 60.0 Hz	0.1s	0.5	N	
F24	(Holding time)	0.0 to 10.0s	0.1 Hz	0.0	N	
F25	Stop frequency	0.1 to 6.0 Hz	0.1 Hz	0.2	N	
F26	Motor sound (Carrier frequency)	0.75,1 to 15kHz	1kHz	2	Y	
F27	(Sound tone)	0 to 3	1	0	Y	

Y: The data can be changed by the UP or DOWN key during drive operation. However, press the FUNC/DATA key to store the new data.

Y*: Press the UP or DOWN key to change the data. The new data takes effect after the FUNC/DATA key is pressed to store the data.

N: The data can be changed only while the drive is stopped.

F: Fundamental functions (continued)

Function Code	Name	Setting Range	Min. Unit	Factory Setting	Change during operation	User Setting
F29	FMA and FMP terminals (select)	0: Analog output (FMA) 1: Pulse train output (FMP)	1	0	N	
F30	FMA (Voltage Adjust)	0 to 200%	1%	100	Y	
F31	(Function)	0: Output frequency 1: Output frequency 2: Output current 3: Output voltage 4: Output torque 5: Load Factor 6: Input power 7: PID feedback value 8: DC link circuit voltage	1	0	Y*	
F33	FMP (Pulse rate) (Pulse rate)	300 to 6000p/s (Pulse count at 100%)	1p/s	1440	Y	
F34	(Voltage adjustment)	0%, 1 to 200%	1%	0	Y	
F35	(Function)	0 to 8 (Same as F31)	1	0	Y*	
F36	30Ry	0: Activated when tripped 1: Activated during regular operation	1	0	N	
F40	Torque limiter (Driving)	20 to 200% 999: Inactive	1%	999	Y	
F41	(Braking)	0%: Automatic deceleration control 20 to 200% 999: Inactive	1%	999	Y	
F42	Torque vector control 1	0: Inactive 1: Active	1	0	N	

E: Extension terminal functions/ Digital Input/Output functions

E01	X1 terminal function	0: Multistep frequency 1: Multistep frequency 2: Multistep frequency 3: Multistep frequency 4: Acceleration/deceleration time selection [RT1]	1	0	N	
E02	X2 terminal function	5: 3-wire operation stop command [HLD] 6: Coast-to-stop command [BX] 7: Alarm reset [RST]		1	N	
E03	X3 terminal function	8: Trip command (External fault) [THR] 9: Frequency 10: Motor 2/Motor 1 [M2/M1] 11: DC brake command [DCBRK]		2	N	
E04	X4 terminal function	12: Torque limiter 2/Torque limiter 1 [TL2/TL1] 13: UP command [UP] 14: DOWN command [DOWN] 15: Write enable for KEy 16: PID control cancel [Hz/PID]		6	N	
E05	X5 terminal function	17: Inverse mode changeover [IVS] (terminal 12 and C1) 18: Communications link enable [LE]		7	N	
E10	Acceleration time 2	0.01 to 3600s	0.01s	10.0	Y	
E11	Deceleration time 2			10.0	Y	
E16	Torque limiter 2 (Driving)	20 to 200% 999: Inactive	1%	999	Y	
E17	(Brake)	0%: Automatic deceleration control, 20 to 200% 999: Inactive	1%	999	Y	
E20	Y1 terminal function	0: Drive run [RUN] 1: Frequency arrival at setpoint (FAR) 2: Frequency level detection 3: Undervoltage detection signal [LV] 4: Torque polarity 5: Torque limiting [TL]	1	0	N	
E21	Y2 terminal function	6: Auto restarting [IPF] 7: Overload early warning [OL] 8: Life time alarm [LIFE] 9: Frequency arrival at setpoint (FAR2)		7	N	

Y: The data can be changed by the UP or DOWN key during drive operation. However, press the FUNC/DATA key to store the new data.

Y*: Press the UP or DOWN key to change the data. The new data takes effect after the FUNC/DATA key is pressed to store the data.

N: The data can be changed only while the drive is stopped.

Function Code	Name	Setting Range	Min. Unit	Factory Setting	Change during operation	User Setting
E: Extension terminal functions/ Digital Input/Output functions (continued)						
E29	Frequency detection delay	0.01 to 10.0s	0.01s	0.10	Y	
E30	FAR function signal (Hy)	0.0 to 10.0 Hz	0.1 Hz	2.5	Y	
E31	FDT function signal (Level)	0 to 400 Hz	1 Hz	60	Y	
E32	(Hy)	0.0 to 30.0 Hz	0.1 Hz	1.0	Y	
E33	OL function signal (Mode select)	0: Electronic thermal overload relay 1: Output current	1	0	Y*	
E34	(Level)	20 to 200% of the rated drive current	0.01A	rated motor current	Y	
E35	(Timer)	0.0 to 60.0s	0.1s	10.0	Y	
E40	Display A	0.00 to 200.0	0.01	0.01	Y	
	B	0.00 to 200.0	0.01	0.00	Y	
E42	LED display	0.0 to 5.0s	0.1s	0.5	Y	

C: Control function of frequency

C01	Jump frequency (Jump freq. 1)	0 to 400 Hz	1 Hz	0	Y	
C02	(Jump freq. 2)			0	Y	
C03	(Jump freq. 3)			0	Y	
C04	(Hysteresis)			3	Y	
C05	Multistep frequency (Freq. 1)	0.00 to 400.0 Hz	0.01 Hz	0.00	Y	
C06	(Freq. 2)			0.00	Y	
C07	(Freq. 3)			0.00	Y	
C08	(Freq. 4)			0.00	Y	
C09	(Freq. 5)			0.00	Y	
C10	(Freq. 6)			0.00	Y	
C11	(Freq. 7)			0.00	Y	
C12	(Freq. 8)			0.00	Y	
C13	(Freq. 9)			0.00	Y	
C14	(Freq. 10)			0.00	Y	
C15	(Freq. 11)			0.00	Y	
C16	(Freq. 12)			0.00	Y	
C17	(Freq. 13)			0.00	Y	
C18	(Freq. 14)			0.00	Y	
C19	(Freq. 15)			0.00	Y	
C21	Timer operation auto-stop	0: Inactive 0: Active	1	0	N	
C22	Auto-stop time	0.00 to 3600s	0.01s	0.00	Y	
C30	Frequency command 2	0 to 8 (same as F01)	1	2	N	
C31	Analog setting signal offset adjustment (Terminal 12)	-5.0 to +5.0%	0.1%	0.0	Y	
C32	(Terminal C1)	-5.0 to +5.0%	0.1%	0.0	Y	
C33	Analog setting signal filter	0.00 to 5.00s	0.01s	0.05	Y	

P: Motor parameters

P01	Number of motor 1 poles	2 to 14	2	4	N	
P02	Motor 1 (Capacity)	0.01 to 7.5 Hp (5 Hp or less) 0.01 to 15 Hp (7.5/10 Hp)	0.01 Hp	Nominal applied motor Hp	N	
P03	(Rated current)	0.00 to 99.9A	0.01A	standard rating	N	
P04	(Tuning)	0: Inactive 1: Active (%R1, %X) 2: Active (%R1, %X, Io)	1	0	N	
P05	(Online tuning)	0: Inactive 1: Active	1	0	N	

Y: The data can be changed by the UP or DOWN key during drive operation. However, press the FUNC/DATA key to store the new data.

Y*: Press the UP or DOWN key to change the data. The new data takes effect after the FUNC/DATA key is pressed to store the data.

N: The data can be changed only while the drive is stopped.

Function Code	Name	Setting Range	Min. Unit	Factory Setting	Change during operation	User Setting															
P: Motor parameters (continued)																					
P06	(No-load current)	0.00 to 99.9A	0.01A	standard rating	N																
P07	(%R1 setting)	0.00 to 50.00%	0.01%	standard rating	Y																
P08	(%X setting)	0.00 to 50.00%	0.01%	standard rating	Y																
P09	(Slip compensation control 1)	0.00 to 15.0 Hz	0.01 Hz	0.00	Y																
P10	(Slip compensation response time 1)	0.01 to 10.00s	0.01s	0.50	Y																
H: High performance functions																					
H01	Total operating time	Monitor only	10h	0	—																
H02	Trip history	Monitor only	—	—	—																
H03	Data initializing (Data reset)	0: Disabled 1: Initialized data function	1	0	N																
H04	Auto-reset (Times)	0: Inactive 1 to 10 times	1 time	0	Y																
H05	(Reset interval)	2 to 20s	1s	5	Y																
H06	Fan stop operation	0: Inactive 1: Active	1	0	Y																
H07	ACC/DEC pattern (Mode select)	0: Linear acceleration/deceleration 1: S-curve acceleration/deceleration (weak) 2: S-curve acceleration/deceleration (strong) 3: Non-linear	1	0	N																
H09	Start mode (Rotating motor pickup mode)	0: Inactive 1: Active (Only) 2: Active (all start mode)	1	0	N																
H10	Energy saving operation	0: Inactive 1: Active	1	0	Y																
H11	Decel mode	0: Normal 1: Coast-to-stop	1	0	Y																
H12	Instantaneous overcurrent limiting	0: Inactive 1: Active	1	1	N																
H13	Auto-restart (restart time)	0.1 to 5.0s	0.1s	0.1	N																
H14	Frequency fall rate	0.00 to 100.0 Hz	0.01Hz/s	10.00	Y																
H20	PID control (Mode select)	0: Inactive 1: Forward operation 2: Reverse operation	1	0	N																
H21	(Feedback signal)	0: Terminal 12 (0 to +10 VDC) input 1: Terminal C1 (4 to 20 mA) input 2: Terminal 12 (+10 to 0 VDC) input 3: Terminal C1 (20 to 4 mA) input	1	1	N																
H22	P (Gain)	0.01 to 10.00 times (1 to 1000%)	0.01 time	0.10	Y																
H23	I (Integral time)	0.0: Inactive 0.1 to 3600s	0.1s	0.0	Y																
H24	D (Differential time)	0.00: Inactive 0.01 to 10.0s	0.01s	0.00	Y																
H25	(Feedback filter)	0.0 to 60.0s	0.1s	0.5	Y																
H26	PTC thermistor (Mode select)	0: Inactive 1: Active		0	Y																
H27	(Level)	0.00--5.00V	0.01V	1.60	Y																
H28	Droop operation	-9.9 --0.0 Hz	0.1 Hz	0.0	Y																
H30	Serial link (Function select)	<table border="0"> <tr> <td>Monitor</td> <td>Frequency setting</td> <td>Operation command</td> </tr> <tr> <td>0: X</td> <td>—</td> <td>—</td> </tr> <tr> <td>1: X</td> <td>X</td> <td>—</td> </tr> <tr> <td>2: X</td> <td>—</td> <td>X</td> </tr> <tr> <td>3: X</td> <td>X</td> <td>X</td> </tr> </table>	Monitor	Frequency setting	Operation command	0: X	—	—	1: X	X	—	2: X	—	X	3: X	X	X	1	0	Y	
Monitor	Frequency setting	Operation command																			
0: X	—	—																			
1: X	X	—																			
2: X	—	X																			
3: X	X	X																			

Y: The data can be changed by the UP or DOWN key during drive operation. However, press the FUNC/DATA key to store the new data.

Y*: Press the UP or DOWN key to change the data. The new data takes effect after the FUNC/DATA key is pressed to store the data.

N: The data can be changed only while the drive is stopped.

Function Code	Name	Setting Range	Min. Unit	Factory Setting	Change during operation	User Setting
H: High performance functions (continued)						
H31	Modbus-RTU (Address)	0: Broadcast 1 to 247: Query	1	1	N	
H32	(Mode select on no response error)	0: Immediate Er8 1: Er8 after interval set by 2: Retry 3: Continuation of operation	1	0	Y	
H33	(Timer)	0.0 to 60.0s	0.1s	2.0	Y	
H34	(Baud rate)	0: 19200 [bit/s] 1: 9600 2: 4800 3: 2400	1	1	Y	
H35	(Data length)	0: 8 bit (Fixed)	1	0	—	
H36	(Parity)	0: None 1: Even parity 2: Odd parity	1	0	Y	
H37	(Stop bits)	0: 2 bits 1: 1 bit	1	0	Y	
H38	(No response error detection time)	0: Not detected 1: 1 to 60s	1s	0	Y	
H39	(Response interval)	0.00 to 1.00s	0.01s	0.01	Y	
H40	Maximum temperature of heatsink	Monitor only	degree C	—	—	
H41	Maximum effective current	Monitor only	A	—	—	
H42	Main circuit capacitor life	Monitor only	%	—	—	
H43	Cooling fan operation time	Monitor only	10h	—	—	
H44	Drive ROM version	Monitor only	—	—	—	
H45	Key	Monitor only	—	—	—	
H46	Option ROM version	Monitor only	—	—	—	

A: Alternative motor parameters

A01	Maximum frequency	50 to 400 Hz	1 Hz	60	N	
A02	Base frequency	25 to 400 Hz	1 Hz	60	N	
A03	Rated voltage 2 (at base frequency)	0V, 80 to 240V (230V class) 0V, 160 to 480V (460V class)	1V	230 460	N	
A04	Maximum boltage 2 (at maximum frquency)	80 to 240 V (230V class) 160 to 480V (460V class)	1V	230 460	N	
A05	Torque boost 2	0, 1, 2, 3 to 31	1	13	Y	
A06	Electronic thermal overload relay	0: Inactive 1: Active (for general purpose motors) 2: Active (for forced air extended operating range motors)	1	1	Y*	
A07	(Level)	20 to 135% of the rated drive current	0.01A	rated motor current	Y	
A08	(Thermal time constant)	0.5 to 10 min.	0.1 min	5.0	Y	
A09	Torque vector control 2	0: Inactive 1: Active	1	0	N	
A10	Number of motor 2 poles	2 to 14	2	4	N	
A11	Motor 2 (Capacity)	0.01 to 7.5 Hp (5 Hp or smaller) 0.01 to 15 Hp (7.5/10 Hp)	0.01kW	Nominal applied motor kW	N	
A12	(Rated current)	0.00 to 99.9A	0.01A	standard rating	N	
A13	(Tuning)	0: Inactive 1: Active (%R1, %X) 2: Active (%R1, %X, lo)	1	0	N	
A14	(Online tuning)	0: Inactive 1: Active	1	0	N	
A15	(N0-load current)	0.00 to 99.9A	0.01A	standard rating	N	
A16	(%R setting)	0.00 to 50.00%	0.01%	standard rating	Y	
A17	(%X setting)	0.00 to 50.00%	0.01%	standard rating	Y	
A18	(Slip compensation control 2)	0.00 to 15.00 Hz	0.01 Hz	0.00	Y	
A19	(Slip compensation response time 2)	0.01 to 10.00s	0.01s	0.50	Y	

Y: The data can be changed by the UP or DOWN key during drive operation. However, press the FUNC/DATA key to store the new data.

Y*: Press the UP or DOWN key to change the data. The new data takes effect after the FUNC/DATA key is pressed to store the data.

N: The data can be changed only while the drive is stopped.

F: Fundamental functions

F00 Data protection

F 0 0

- 0: Data can be changed
- 1: Data cannot be changed

Note: This function protects the system by blocking any data changes entered from the keypad.

Setting Procedure:

0 → 1: Press the **STOP** + **▲** keys simultaneously.

Then press the **FUNC DATA** to save.

1 → 0: Press the **STOP** + **▼** keys simultaneously.

Then press the **FUNC DATA** to save.

F01 Frequency command 1

F 0 1

This function determines the method used for setting the reference frequency.

- 0: The frequency is set by the operation of **▲** and **▼** keys.
- 1: The frequency is set by the voltage input at terminal 12 (0 to +10 Vdc).
- 2: The frequency is set by the current input at terminal C1 (4 to 20 mA).
- 3: The frequency is set by the voltage and current input at terminal 12 and terminal C1 ((-10 to +10 Vdc) plus (4 to 20 mA)). Inputs at terminals 12 and C1 are added to determine the total frequency reference.
- 4: The reversible frequency operation set by the voltage input polarity operation at terminal 12 (-10 to +10 Vdc).

Note: The input voltage polarity can result in motor rotation opposite the operation command.
- 5: Frequency is set by voltage input-inverse mode operation at terminal 12 (+10 to 0 Vdc).
- 6: The frequency is set by current input-inverse mode operation at terminal C1 (20 to 4 mA).
- 7: UP/DOWN control mode 1: The frequency is set by terminal UP and DOWN terminal. (initial set value = 0)

- 8: UP/DOWN control mode 2: The frequency is set by terminal UP and terminal DOWN (initial value = last value during previous operation).

Refer to the description of the **E01** to **E05** functions for details.

Description of forward and reverse operation

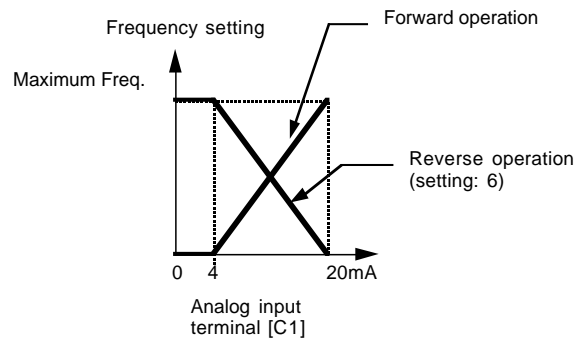
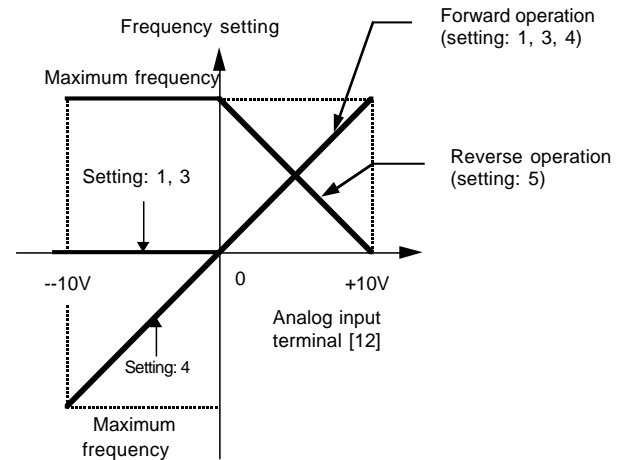

F02 Operation method

F 0 2

This function determines the input method for operation commands.

- 0: Keypad operation (**RUN** **STOP** key)

The motor runs when the **RUN** key is pressed and decelerates-to-stop when the **STOP** key is pressed.

Note: The rotation direction depends on the FWD and REV terminals as follows:

- FWD-CM connected: Forward
- REV-CM connected: Reverse

No operation if both the FWD and REV terminals or neither of them are connected to the CM terminal.

- 1: External signal on the terminal board (FWD, REV).
Forward operation with FWD-CM connected and deceleration to stop when opened.

Reverse operation with REV-CM connected and deceleration to stop when opened.

No operation if both FWD-CM and REV-CM are connected.

STOP key active (see following page chart for details)

- 2: External signal on the terminal boards (FWD, REV).
Forward operation with FWD-CM connected and deceleration to stop when opened.

Reverse operation with REV-CM connected and deceleration to stop when opened.

No operation if both FWD-CM and REV-CM are connected at the same time.

STOP key inactive (see following page chart for details)

- 3: External signal on the terminal boards (FWD, REV).
Forward operation with FWD-CM connected and deceleration to stop when opened.

Reverse operation with REV-CM connected and deceleration to stop when opened.

No operation with both FWD-CM and REV-CM are connected at the same time.

STOP key active with start software (see following page chart for details)

- 4: External signal on the terminal boards (FWD,REV).
Forward operation with FWD-CM connected and deceleration to stop when opened.

Reverse operation with REV-CM connected and deceleration to stop when opened.

No operation with both FWD-CM and REV-CM are connected at the same time.

STOP key inactive with start software (see following page chart for details)

Note: This function can be changed only while the FWD and REV terminals are opened.

Start Software Selection During Terminal Operation

	Inactive: Setting 1 or 2	Active: Setting 3 or 4
POWER ON	<p>Timing diagram for Power On (Inactive: Setting 1 or 2). The signals are: POWER (rises), FWD (rises), OUTPUT (rises), and ALARM (no signal).</p>	<p>Timing diagram for Power On (Active: Setting 3 or 4). The signals are: POWER (rises), FWD (rises), OUTPUT (rises), and ALARM (ER6 pulse).</p>
RESET	<p>Timing diagram for Reset (Inactive: Setting 1 or 2). The signals are: RESET (pulse), FWD (rises), OUTPUT (rises), and ALARM (no signal).</p>	<p>Timing diagram for Reset (Active: Setting 3 or 4). The signals are: RESET (two pulses), FWD (rises), OUTPUT (rises), and ALARM (Multi Alarms* pulse).</p>
NETWORK MODE	<p>Timing diagram for Network Mode (Inactive: Setting 1 or 2). The signals are: NETWORK (LE-CM) (pulse), FWD (TERMINAL) (rises), FWD (NETWORK) (rises), OUTPUT (rises), and ALARM (no signal).</p>	<p>Timing diagram for Network Mode (Active: Setting 3 or 4). The signals are: NETWORK (LE-CM) (pulse), FWD (TERMINAL) (rises), FWD (NETWORK) (rises), OUTPUT (rises), and ALARM (ER6 pulse, followed by a RESET pulse, followed by another ER6 pulse).</p>

Note: Start Software does not work at AUTO RESET mode and PROGRAMMING mode

Stop Key Mode Selection During Terminal Operation

	Inactive: Setting 2 or 4	Active: Setting 1 or 3
STOP KEY TERMINAL MODE	<p>Timing diagram for Stop Key Terminal Mode (Inactive: Setting 2 or 4). The signals are: FWD (rises), STOP (pulse), OUTPUT (rises), and ALARM (no signal).</p>	<p>Timing diagram for Stop Key Terminal Mode (Active: Setting 1 or 3). The signals are: FWD (rises), STOP (pulse), OUTPUT (rises), and ALARM (ER6 pulse).</p>
STOP KEY NETWORK MODE	<p>Timing diagram for Stop Key Network Mode (Inactive: Setting 2 or 4). The signals are: NETWORK (LE-CM) (pulse), FWD (TERMINAL) (rises), STOP (pulse), OUTPUT (rises), and ALARM (no signal).</p>	<p>Timing diagram for Stop Key Network Mode (Active: Setting 1 or 3). The signals are: NETWORK (LE-CM) (pulse), FWD (TERMINAL) (rises), STOP (pulse), OUTPUT (rises), and ALARM (ER6 pulse).</p>

Frequency Setting Block Diagram

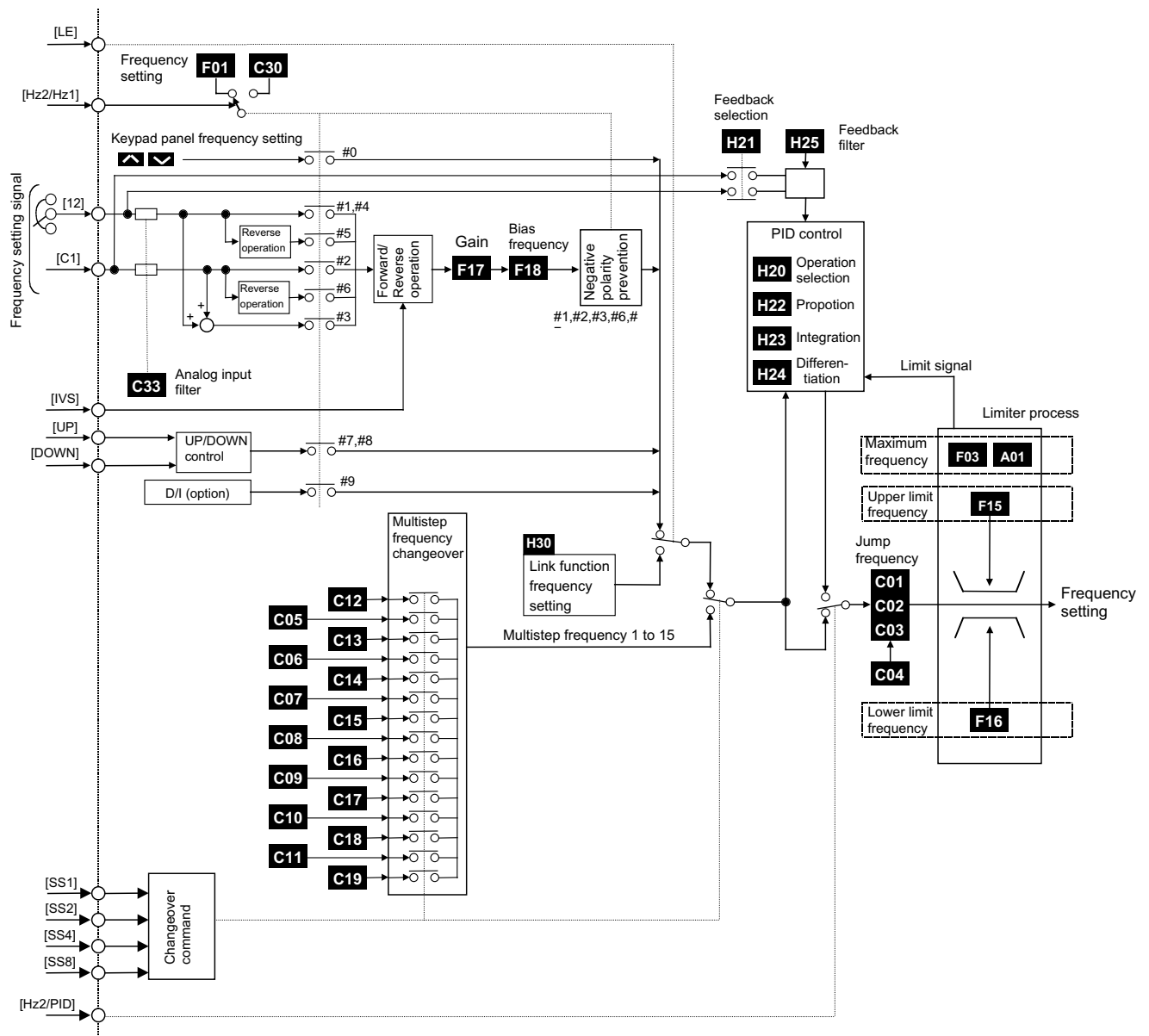

F03 Maximum output frequency 1

F 0 3

Setting range: 50 to 400 Hz

This function sets the maximum output frequency for Motor 1.

If a value larger than the rating maximum speed of the motor is set, the motor may be damaged.

F04 Base frequency 1

F 0 4

Setting range: 25 to 400 Hz

This sets the maximum output frequency in the constant torque range of Motor 1, or the output frequency at the rated output voltage. Set it to match rating of the motor.

Note: If the value of base frequency 1 is larger than the value of maximum frequency 1, the output frequency is limited by the maximum frequency, and the output voltage does not increase to the rated voltage.

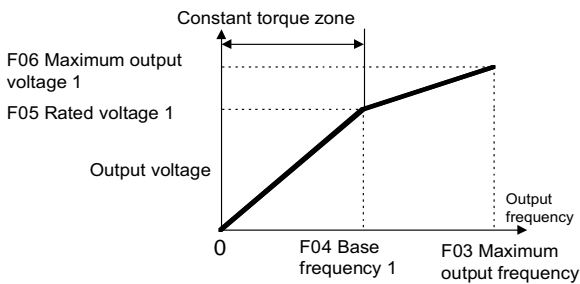

F05 Rated voltage 1

F 0 5

Setting range: 0, 80 to 240 V for 230 V class.
0, 160 to 480V for 460 V class.

This function sets the rated value of the output voltage Motor 1. However, output voltages cannot exceed the source (input) voltage.

A "0" setting stops the operation of the voltage regulator function. Therefore the output voltage is proportional to the source voltage is output.

Note: If the value of rated voltage is higher than the value of maximum output voltage, the voltage is limited by the maximum output voltage and does not increase to the rated voltage.

F06 Maximum voltage 1

F 0 6

Setting range: 80 to 240 V for 230V class
160 to 480V for 460V class

This function sets the maximum value of the output voltage for Motor 1. However, output voltage cannot exceed the source (input) voltage.

F07 Acceleration time 1

F 0 7

F08 Deceleration time 1

F 0 8

Setting range: Acceleration time 1: 0.01 to 3600 s
Deceleration time 1: 0.01 to 3600 s

These functions set the acceleration time taken for the output frequency to reach the maximum frequency from the start command, and the deceleration time taken to stop from the maximum output frequency.

The number of significant digits of the acceleration and deceleration time is three. Therefore, only the uppermost three digits can be set.

The acceleration time and deceleration times are set based on the maximum frequency. The relationship between the frequency setting and the acceleration/ deceleration time is as shown below.

Set frequency = max. frequency

The actual operation time matches the set value.

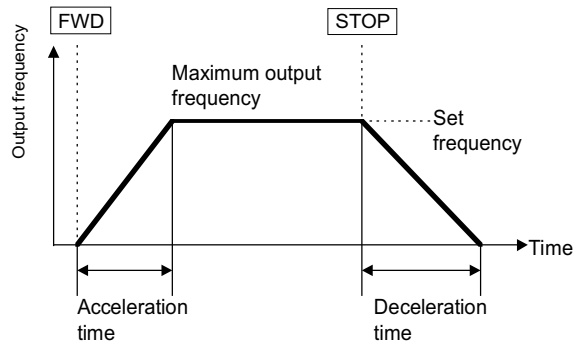

Set frequency < Maximum output frequency

The accel/decel times differ from the set value.

Acceleration/deceleration time = Set value x (Set frequency / Maximum output frequency)

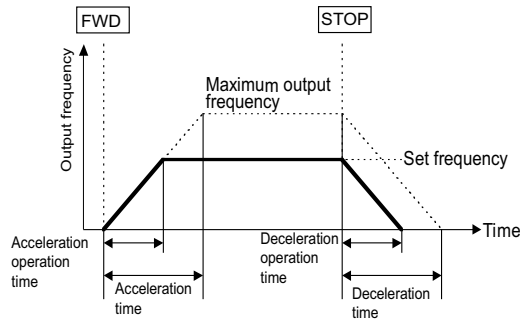

Note: If an excessively short acceleration or deceleration time is set and the load torque or moment of inertia of the load is large, the torque limiter or stall prevention function will be activated. When these functions are activated, the time becomes longer than the operation time explained above.

F09 Torque boost 1

F 0 9

This function is for motor 1. The following options can be selected.

- Selection of load characteristics such as automatic torque boost, variable torque load, proportional torque load and constant torque load.
- Correction of magnetic flux of the motor because of the voltage drop in the low frequency zone, and torque boost during low speed operation (boosting of V/f characteristics).

Setting range	Description of selection
0	Automatic torque boost characteristics. The torque boost value of the constant torque load is automatically adjusted (refer to function code P04 "Motor 1 ("Tuning)").
1	Variable torque characteristics for fan and pump loads
2	Proportional torque characteristics for intermediate loads between the variable torque and constant torque characteristics.
3 to 31	Constant torque characteristics

Torque characteristics:

<Variable torque characteristics>

<Proportional torque characteristics>

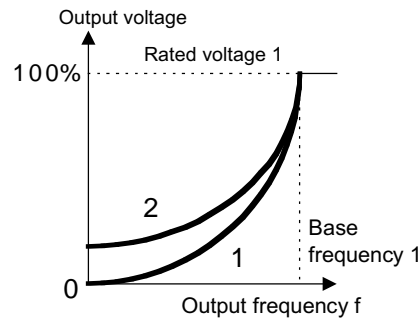

<Constant torque characteristics>

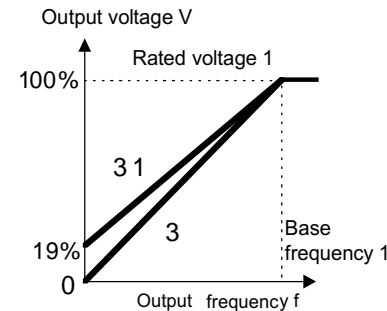

Note: When the torque boost value is excessively large, the motor is over excited in the low speed zone for all types of characteristics. If operation continues in this state, the motor performance is reduced and may be overheated. Check the characteristics of the motor.

F10 Electronic thermal overload relay 1 (Select)

F11 Electronic thermal overload relay 1 (Level)

F12 Electronic thermal overload relay 1 (Thermal time constant)

The electronic thermal overload relay function monitors the output frequency, output current and operation time of the drive to prevent the motor from overheating. The protective function becomes active when 150% of the set amperage flows for the time set at F12 (thermal time constant).

F 1 0

Setting: 0 Inactive

1 Active (for general purpose motor)

2 Active (for forced air or extended operation range motor)

This function selects between active and inactive operation of the electronic thermal overload relay and also selects the target motor's characteristics. When a general purpose motor is selected, the operation level is low at low speeds matching to the cooling characteristics of the motor.



The operation level of the electronic thermal overload relay is set in amps. A value from 1.0 to 1.1 times rated current of the motor should be entered.

The setting range is 20 to 135% of the rated inverter current.

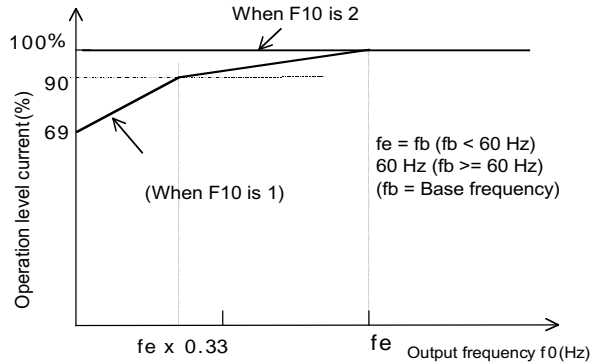

Graph of relationship between operation level current and output frequency

F 1 2

Setting range: 0.5 to 10.0 min.
(minimum unit 0.1 minute)

This function sets the time allowed for 150% current flow and operation of the overload fault.

Typical current - operation time characteristics

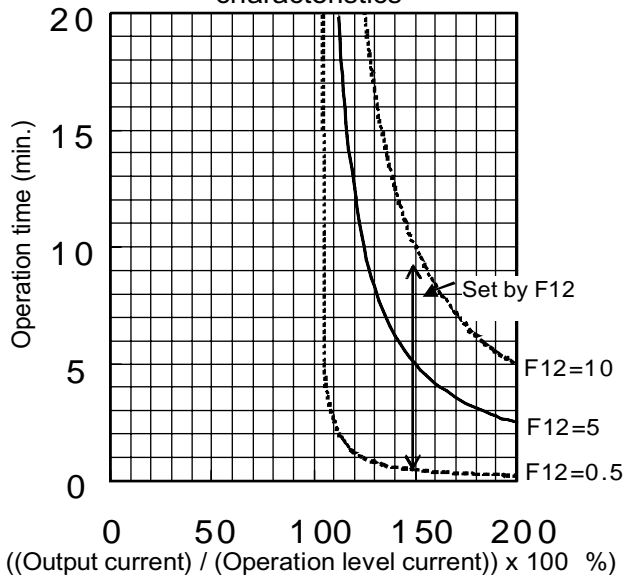

F13 Electronic thermal overload relay (for External braking resistor)

F 1 3

- Setting 0: Inactive
- 1: Active
(For external braking up to 3 Hp)
- 2: Active
(For external braking 7.5 to 10 Hp)

This function prevents the braking resistor from being overheated, due to the frequency of the braking as well as the duration of operation.

F14 Restart mode after momentary power failure

F 1 4

Setting range: 0 to 3 (Refer to the table below for details of the function.)

This function determines the response of the drive upon momentary power failure.

Selection can be made for protective operation (alarm output, alarm display, and drive output shutoff) upon detection of power failure. Different responses to undervoltage and momentary power failure can be selected. Different types of restart options are also available per the table on page 5-13.

Function codes used for restart after momentary power failure include H13 and H14. Refer to the description of these codes. A rotating motor "pickup function" can be selected as the starting method after a momentary power failure. (Refer to function code H09 for details of setting.)

Setting	Name of function	Operation upon power failure	Operation upon power recovery	
0	Inactive after momentary power failure (The drive trips immediately.)	Upon detection of an undervoltage, a protective function is activated to stop the output.	The drive does not restart.	The drive restarts after the protective function is reset and an operation command is input.
1	Inactive after momentary power failure (The drive trips after the power is recovered.)	Upon detection of an undervoltage, no protective function is activated but the output is stopped.	A protective function is activated; the drive does not restart.	
2	Restart after momentary power failure (The drive restarts at the frequency effective at the time of power failure.)	Upon detection of an undervoltage, no protective function is activated but the output is stopped.	The drive automatically restarts at the output frequency effective at the time of power failure.	
3	Restart after momentary power failure (The drive restarts at the starting frequency; for low inertia loads.)	Upon detection of an undervoltage, no protective function is activated but the output is stopped.	The drive automatically restarts at the starting frequency set at F23.	

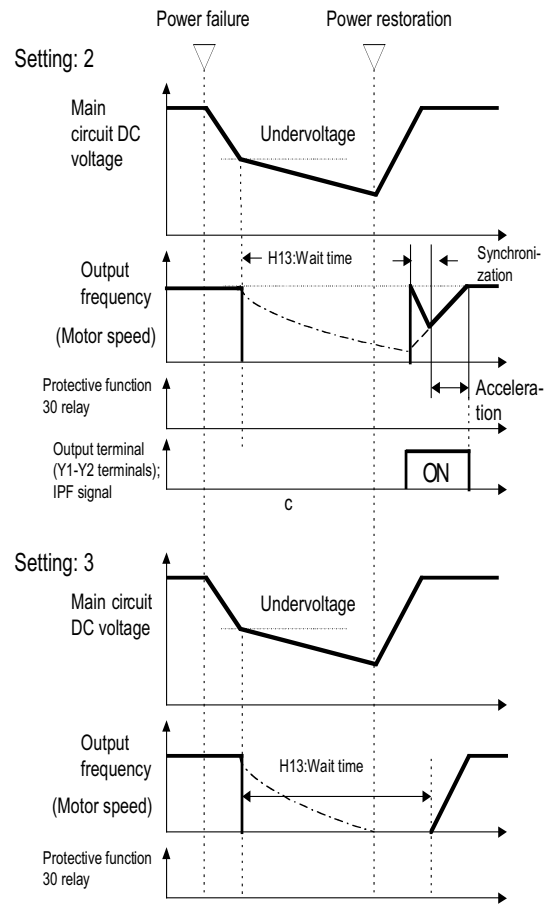
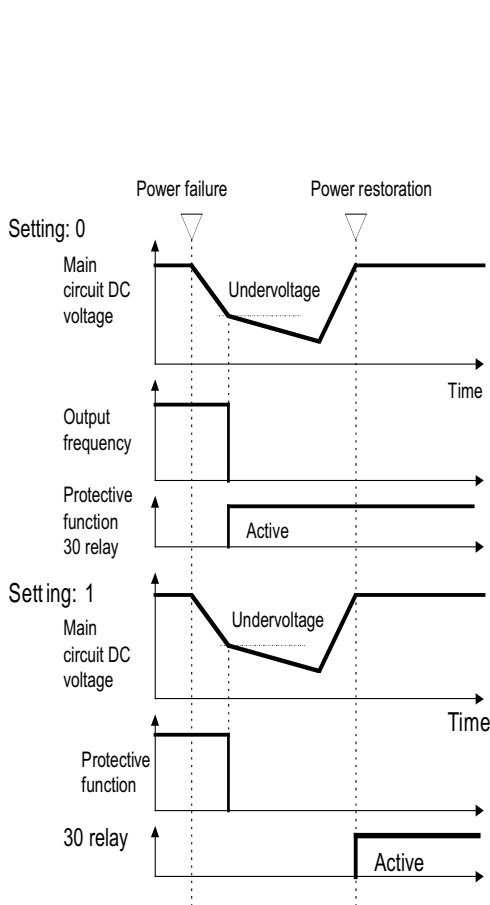

Set the upper and lower limits of the frequency setting.

When the “pickup function” is used, the speed of the coasting motor is detected and the motor is started without a shock. Because a speed detection time is necessary for the pickup function, it should not be used with systems with large inertias, since the loss in speed will be small.

The effective range of the pickup function is 5 to 120 Hz. If the detected speed is out this range, the drive restarts according to the restart function selected.

Note: The dotted-dashed line indicates the motor speed.

F15 Frequency limiter (High)

F 1 5

F16 Frequency limiter (Low)

Setting range: 0 to 400 Hz

These functions are used to define the upper and lower operating limits of the set frequency.

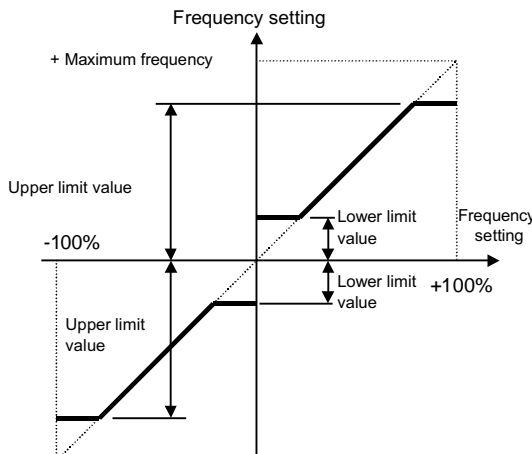

The starting frequency is output when the drive starts operation, and the stopping frequency is output when it stops operation.

Note: Lowlimit > High limit ... Priority is given to the High limit value.

F17 Gain (Frequency setting signal)



This function sets the ratio of the set frequency to the analog input.

The operation is as shown in the figure.

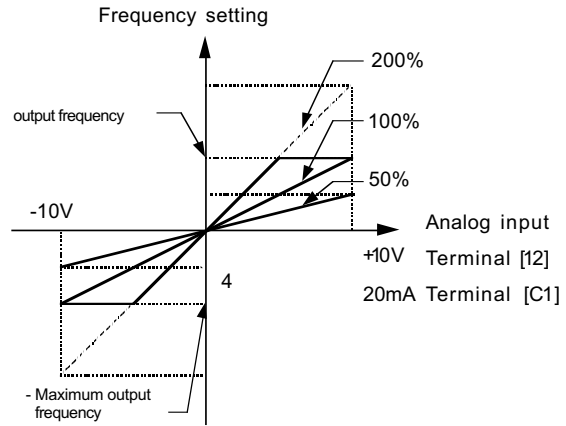

F18 Bias frequency

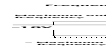

This function determines the set frequency from addition of the analog input and a bias frequency. The operation is as shown in the figure below.

If the bias frequency is larger than the maximum frequency, the limit is set at the maximum output frequency. The same is true for bias frequency in the negative direction.

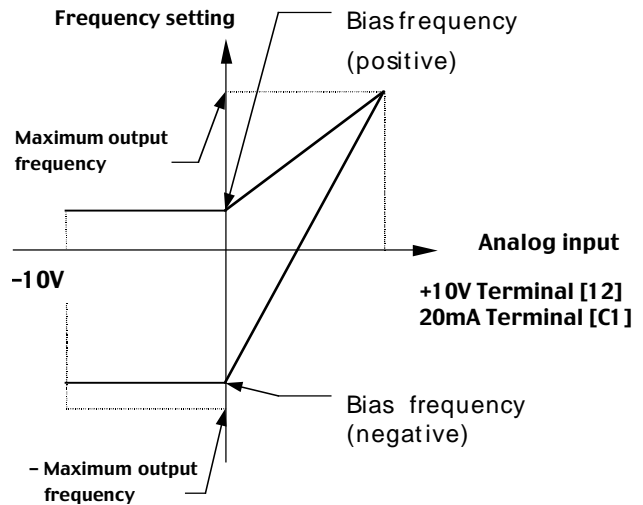

F20 DC brake (Starting frequency)

F21 DC brake (Braking level)

F22 DC brake (Braking time)

F 2 0

Setting range: 0.0 to 60.0 Hz

Starting frequency: Sets the frequency at which the DC braking starts during deceleration.

F 2 1

Setting range: 0 to 100%

Braking level: Sets the output current level during DC braking. The level can be set in increments of 1% of the rated drive output current.

F 2 2

Setting range: 0.0 Inactive
0.1 to 30.0 s

Braking time: Sets the operation time of DC braking.

CAUTION

The brake function of the drive is not a substitute for a mechanical brake. **Injuries could occur.**

F23 Starting frequency(Frequency)

F24 Starting frequency (Holding time)

F25 Stop frequency

The starting frequency can be used to help insure torque during starting. Holding time at the start frequency can be used to wait for the establishment of the magnetizing flux of the motor.

F 2 3

Setting range: 0.1 to 60.0 Hz

Frequency: Sets the starting frequency.

F 2 4

Setting range: 0.0 to 10.0 s

Holding time: Sets the time for maintaining the starting frequency before acceleration occurs.

- * The Holding time is not used during continuous operation between forward and reverse directions.
- * The Holding time is not included in the acceleration time.
- * The function is effective even when C21, Timer operation, is selected; the time is included in the timer value.

F 2 5

Setting range: 0.1 to 6.0 Hz

Sets the stop frequency.

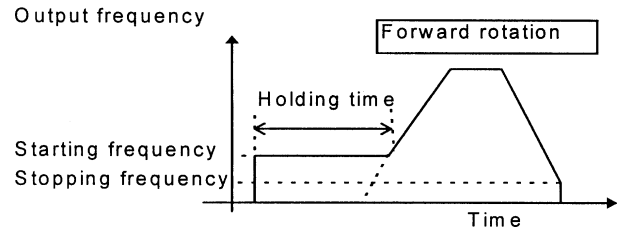

When the starting frequency is less than the stop frequency, or the set frequency is smaller than the stop frequency, this function is not utilized.

F26 Motor sound (Carrier frequency)

F 2 6

Setting range: 0.75 to 15 (0.75 to 15 kHz)

This function adjusts the drive's carrier frequency. It can be used for reduction of the motor noise, avoidance of resonance with the mechanical system, reduction of leakage current from the output circuit wiring, reduction of drive noise and other performance issues.

Carrier frequency	Lower		Higher
Motor noise	Larger	to	Smaller
Output current waveform	Worse	to	Better
Leakage current	Less	to	More
Noise generation	Less	to	More

Note: Lower settings cause distorted output current waveform with high harmonic content which causes an increase in the motor losses, resulting in slightly higher motor temperatures.

For example, when 0.75 kHz is set, reduce the motor rated torque by about 15%. When a large value is set, the drive losses increase, raising the drive temperature.

F27 Motor sound (Sound tone)

F 2 7

Setting range: 0, 1, 2, 3

The sound tone of the motor noise can be changed when the carrier frequency is 7 kHz or lower. The function can be used according to preference. It acts as a sweep frequency.

F29 FMA and FMP terminals (Select)

F 2 9

Selects the operation method of the FM terminal.

- 0: Analog output (FMA function)
- 1: Pulse output (FMP function)

F30 FMA (Voltage adjust)

F31 FMA (Function)

The output frequency, current and other monitored parameters can be output to the FM terminal in a DC voltage. The amplitude can be adjusted to match customer needs.

Note: To use the FM terminal for analog outputs, set F29 at "0" and set SW1 on the control board to FMA.

F 3 0

Setting range: 0 to 200 [%]

This parameter adjusts the voltage corresponding to 100 [%] of the monitored parameter selected in F31. The range is from 0 to 200% in increments of 1%.

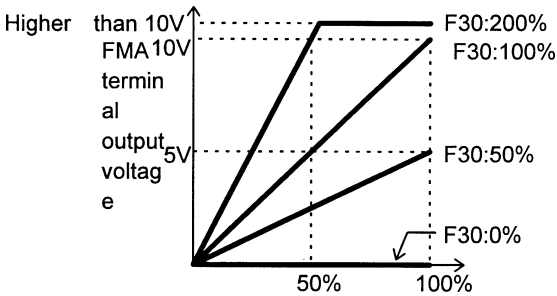

F 3 1

Select the monitored item for the FM terminal output.

Setting	Target of monitoring	Definition of 100% of monitoring amount
0	Output frequency 1 (before slip compensation)	Maximum output frequency
1	Output frequency 2 (after slip compensation)	Maximum output frequency
2	Output current	2 times rated drive output current
3	Output voltage	250V (230V class) 500V (460V class)
4	Output torque	2 times rated motor torque
5	Load factor	2 times rated motor load
6	Input power	2 times rated drive output
7	PID feedback value	100% feedback value
8	DC link circuit voltage	500V (230V class) 1000V (460V class)

F33 FMP (Pulse rate)

F34 FMP (Voltage adjust)

F35 FMP (Function)

The output frequency, output current and other monitored data can be output at the FM terminal in pulse voltages. The output can be connected to an analog meter.

To configure the pulse output, set the F33 pulse rate to a desired value, and set the F34 voltage to 0%.

To configure the average voltage, set the F34 voltage to determine the average voltage; the F33 pulse rate is fixed at 2670 [p/s].

Note: To use the FM terminal for the pulse output, set F29 to "1" and set SW1 on the control board to the FMP.

F 3 3

Setting range: 300 to 6000 [p/s]

This function sets the pulse rate corresponding to 100 [%] of the monitored parameters selected by F35.

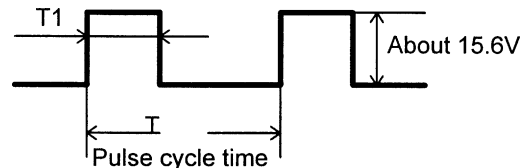

$$\text{Pulse period [p/s]} = 1/T$$

$$\text{Duty [\%]} = T1/T \times 100$$

$$\text{Average voltage [V]} = 15.6 \times T1/T$$

F 3 4

Setting range: 0 to 200 [%]

Sets the average voltage of the pulse output at the FM terminal.

If "0" is set, the pulse frequency varies according to the monitored item selected in F35 (with the maximum value being the F33 setting). If a value between 1 and 200 is set, the pulse frequency is fixed at 2670 p/s. The average voltage corresponding to 100% of the monitored item selected at F35 can be adjusted in a range between 1 and 200% (in an increment of 1%). (The duty cycle of the pulse changes.)

Note : FMP has approx. 0.2V offset voltage even if FMP outputs zero value.

F 3 5

Select the monitored item for the FM terminal output. The selected options are the same as F31.

F36 30Ry operation mode

H 3 6

This function determines whether the alarm output relay (30Ry) is activated (picked up) during normal operation or picked up during a trip.

Setting	Operation
0	Drive no power 30A – 30C: OFF, 30B – 30C: ON
	At normal 30A – 30C: OFF, 30B – 30C: ON
	At alarm 30A – 30C: ON, 30B – 30C: OFF
1	Drive no power 30A – 30C: OFF, 30B – 30C: ON
	At normal 30A – 30C: ON, 30B – 30C: OFF
	At alarm 30A – 30C: ON, 30B – 30C: ON

Note: Because the contact between 30A and 30C is closed after the drive is turned on (about 1 second) care must be taken in the logic sequence design. This occurs if the setting is “1”.

F40 Torque limiter 1 (Driving)

F41 Torque limiter 1 (Braking)

F 4 0 F 4 1

Setting range: 20 to 200,999%

The torque limit operation calculates the motor torque from the output voltage, current, resistance of the primary winding of the motor and other data to control the frequency so that the calculated value does not exceed the control value. This insures drive operation without tripping upon abrupt changes in the load torque while the limit value is still maintained.

Select the limit values of the driving torque and braking torque.

The acceleration/deceleration times may be extended during activation of this function. When the driving torque is limited during constant speed operation, the frequency is lowered to reduce the load torque. (When the braking torque is limited, the opposite occurs.)

Set “999” to deactivate the torque limiter.

Set the braking torque to “0” to automatically avoid OU tripping caused by power regeneration of high inertia loads.

DANGER

If the torque limiter has been selected, the drive may operate at an acceleration/deceleration time or speed different from the set ones. Design the machine and select the drive so that safety is ensured even in such cases.

F42 Torque vector control 1- sensorless

F 4 2

The torque vector control calculates the torque suitable for the load to make the best use of the motor torque. It controls the voltage and current vectors to optimize motor operation.

Setting	State of operation
0	Inactive
1	Active

When “1” (active) is selected, the settings of the following function codes are changed to the following:

1. F09 “Torque boost 1” Operates as “0” value (automatic torque boost).
2. P09 “Slip compensation control” Slip compensation is automatically activated.
3. When “0” is set, the slip compensation for a standard three-phase motor is assumed. When the setting is other than “0”, the programmed setting is used.

Use the torque vector control function under the following conditions.

1. A single motor
Note: If two or more motors are connected, cannot maintain accurate control.
2. The data in motor 1’s function codes (P03 “Rated current”, P06 “No-load current”, P07 “%R1” and P08 “%X”) must be accurate.
Note: If the standard three-phase motor is used, the above data is automatically input when function code P02 “Capacity” is set. When another motor is used, execute auto tuning (P04).
3. The rated motor current must not be significantly smaller than the rated drive current. Though it depends on the motor design, one or two sizes smaller than the drive rating is the smallest motor rating allowed.
4. The wiring distance between the drive and motor must not be greater than 165 ft. (50 m). Long cable runs make accurate control difficult due to the leakage current flowing between the cable and the ground.
5. When a reactor is connected between the drive and the motor or when the wiring impedance is large enough not to be overlooked, change the data using P04 “Auto tuning”.
If these conditions cannot be satisfied, this function should not be used.

- E01 X1 terminal function
- E02 X2 terminal function
- E03 X3 terminal function
- E04 X4 terminal function
- E05 X5 terminal function

E	0	1
E	0	2
E	0	3
E	0	4
E	0	5

The function of each digital input terminal X1 to X5 can be set per the following table:

Setting	Function
0,1,2,3	Multistep frequency selection (1 to 15 steps)
4	Acceleration/deceleration selection (1 step)
5	Self holding selection [HLD]
6	Coast-to-stop command [BX]
7	Alarm reset [RST]
8	External alarm [THR]
9	Frequency setting 2 / frequency setting 1 [Hz2 / Hz1]
10	Motor 2 / motor 1 [M2 / M1]
11	DC injection brake command [DCBRK]
12	Torque limit 2 / torque limit 1 [TL2 / TL1]
13	UP command [UP]
14	DOWN command [DOWN]
15	Editing permission command (data change allowed) [WE-KP]
16	PID control cancel [Hz / PID]
17	Normal/Inverse switching (Terminals 12 and C1) (IVS)
18	Link operation selection (RS485 standard, BUS Option) [LE]

Note: The data numbers not in the above table assigned to E01 through E05 will be inactive.

Multistep frequency

Frequencies set in function codes C05 through C19 can be selected according to external digital inputs. Set digital inputs per the following table to select the desired running frequency.

Multistep frequency selection

Value: 0-3

Combination of input signals				Selected frequency
3	2	1	0	
*[SS8]	[SS4]	[SS2]	[SS1]	
off	off	off	on	C05 Multistep frequency 1
off	off	on	off	C06 Multistep frequency 2
off	off	on	on	C07 Multistep frequency 3
off	on	off	off	C08 Multistep frequency 4
off	on	off	on	C09 Multistep frequency 5
off	on	on	off	C10 Multistep frequency 6
off	on	on	on	C11 Multistep frequency 7
on	off	off	off	C12 Multistep frequency 8
on	off	off	on	C13 Multistep frequency 9
on	off	on	off	C14 Multistep frequency 10
on	off	on	on	C15 Multistep frequency 11
on	on	off	off	C16 Multistep frequency 12
on	on	off	on	C17 Multistep frequency 13
on	on	on	off	C18 Multistep frequency 14
on	on	on	on	C19 Multistep frequency 15

* BCD code designation

Acceleration/deceleration time selection

Value: 4

Acceleration/deceleration times set to function codes E10 and E11 can be selected according to the following external digital inputs.

Input signal	Selected acceleration/deceleration time
4[RT1]	
off	F07 Acceleration time 1 F08 Deceleration time 1
on	E10 Acceleration time 2 E11 Deceleration time 2

3-wire operation start/stop command [HLD]

Value: 5

Used for three-wire operation. When HLD-CM is ON, the FWD or REV signal is maintained, and when it is OFF, the signal is reset.

Note: The drive operates while FWD-CM or REV-CM is on even if HLD-CM is off. An external interlock sequence, which makes FWD-CM and REV-CM off when HLD-CM is off, is required.

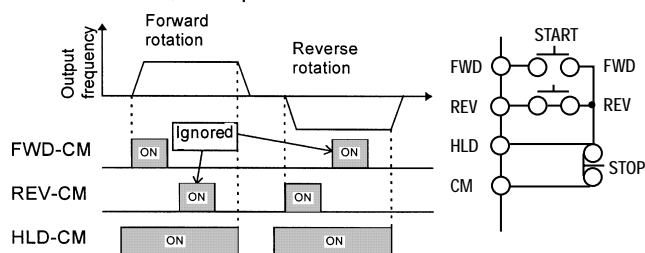

Coast-to-stop command [BX]

Value: 6

When the BX terminal is connected to the CM terminal, the drive output is immediately shut off and the motor coasts to stop. No alarm signal is output nor is the signal maintained.

When the operation command (FWD or REV) is ON and the BX terminal is disconnected from the CM terminal, the motor starts at the starting frequency.

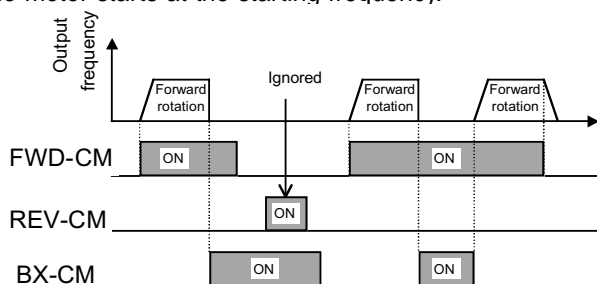

Alarm reset [RST]

Value: 7

When the connection between the RST and CM terminals is made, the alarm output is removed. When the connection is turned off, the trip display is removed and drive is reset.

Trip command (External alarm) [THR]

Value: 8

When the connection between the THR and CM terminals is open, the drive output is shut off (causing the motor to coast to a stop), and an alarm [OH2] is output. This signal is maintained until a RST (reset) input is triggered. This function is used to protect the external braking resistor from being overheated and other external fault condition inputs. When this terminal function is not set, an ON input is assumed.

Frequency setting 2/1 [Hz2 / Hz1]

Value: 9

An external digital input signal switches the frequency setting method defined by function codes F01 and C30. The signal operation is also changed under PID control. (Refer to H20 through H25.)

Input signal	Selected frequency setting
9[Hz2/Hz1]	
off	F01 Frequency setting 1
on	C30 Frequency setting 2

Motor 2/1 [M2 / M1]

Value: 10

An external digital input signal switches between two sets of motor constants. This input is effective only

when the operation command to the drive is turned off and the drive is stopped. Note operation at 0 Hz reference setpoint is not included.

Input signal	Selected motor
10[M2/M1]	
off	Motor 1
on	Motor 2

DC injection brake command (DCBRK)

Value: 11

This function is used for DC braking operation during stopping as well as starting into a rotating load. When the external digital input signal is on and a stop command is given, DC injection braking starts when the drive's output frequency drops below the frequency preset in function code F20. (The operation command goes off when the STOP key is pressed during keypad panel operation or when both terminals FWD and REV go off during terminal block operation.) The DC injection braking continues while the digital input signal is on. In this case, the longer of the following times is selected:

- The time set with function code F22
- The time during which the input signal is set ON

Input signal	Selected Operation
13	
off	DC injection brake command not given
on	DC injection brake command given

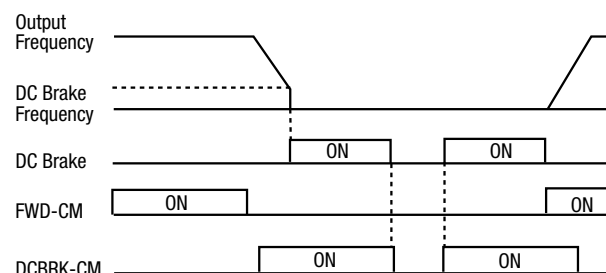

Torque limiter 2/Torque limiter 1 [TL2 / TL1]

Value: 12

An external digital input signal switches between the torque limiter values set in function codes F40 and F41 or E16 and E17.

Input signal	Selected torque limit value
12[TL2/TL1]	
off	F40 Torque limiter 1 (Driving) F41 Torque limiter 1 (Braking)
on	E16 Torque limiter 2 (Driving) E17 Torque limiter 2 (Braking)

UP command [UP] / DOWN command [DOWN]**Value: 13, 14**

The output frequency can be increased or decreased according to the external digital input signal while the run command is present. The range is 0 to the maximum output frequency and operation in a reverse direction to that of the operation command is not allowed.

Input signal		Selected function (when operation command is ON)
13 UP	14 DOWN	
off	off	The output frequency is maintained.
off	on	The output frequency decreases at the deceleration time.
on	off	The output frequency increases at the acceleration time.
on	on	The output frequency is maintained.

Edit Permission for KEYPAD [WE-KP]**Value: 15**

This function allows program changes only while the external signal is input; this protects the program from inadvertent changes.

Input signal	Selected function
15[WE-KP]	
off	Data change disabled
on	Data change enabled

Note: If data 15 is set to a terminal erroneously, turn that "X" terminal ON, then change to another number.

PID control cancel [Hz/PID]**Value: 16**

An external digital input signal can disable the PID control.

Input signal	Selected function
16 [Hz/PID]	
off	PID control valid
on	PID control invalid (frequency setting through keypad panel)

Inverse mode changeover**(Terminal 12 and C1) [IVS]****Value: 17**

An external digital input signal switches between the forward and reverse operations of analog inputs (terminals 12 and C1).

Input signal	Selected function
17[IVS]	
off	When forward operation is set > forward operation When reverse operation is set > reverse operation
on	When forward operation is set > reverse operation When reverse operation is set > forward operation

Link enable (RS485) [LE]**Value: 18**

An external digital input signal is used to enable or disable operation commands from the communications link. The source of the command can be set at H30, Link function.

Input signal	Selected function
18[LE]	
off	Link command invalid
on	Link command valid

E10 Acceleration time 2**E11 Deceleration time 2**

E	1	0
E	1	1

Additional acceleration and deceleration times can be selected besides F07 and F08. The operation and setting range are the same as those for F07 and F08. Refer to these functions.

To switch between the acceleration and deceleration parameters, select any terminal from E01 "X1 terminal (Function selection)" through E05 "X5 terminal (Function selection)" as the switching signal input terminal. Set the selected terminal to "4" (acceleration/deceleration 2 time selection) and supply a signal to the terminal. Switching is effective during acceleration, deceleration or during constant speed operation.

E16 Torque limiter 2 (Driving)

E17 Torque limiter 2 (Braking)

E 1 6
E 1 7

These functions are to switch to the torque limiter levels set in F40 and F41. The external signal is supplied to a control input terminal X1 through X5. The “X” input must be set to torque control 2/torque control 1 (Value = 12).

E20 Y1 terminal function

E21 Y2 terminal function

E 2 0
E 2 1

Selected control and monitor signals can be output at the Y1 and Y2 terminals. They are as follows:

Setting	Digital Output signal
0	Drive running [RUN]
1	Frequency arrival [FAR]
2	Frequency level detection [FDT]
3	Undervoltage detection signal [LV]
4	Torque polarity [B/D]
5	Torque limiting [TL]
6	Restart after momentary power failure [IPF]
7	Overload early warning [OL]
8	Life time alarm [LIFE]
9	Frequency level detection 2 [FAR2]

Drive running [RUN]

Value: 0

“Drive running” means that the drive is outputting a running frequency, as an ON signal. However, if the DC braking function is active, the signal is turned off.

Frequency arrival [FAR]

Value: 1

Refer to the description for function code E30, up-to-speed function Frequency equivalence (detection width).

Frequency level detection [FDT]

Value: 2

Refer to the description for function codes E31 and E32, Frequency level detection.

Undervoltage detection signal [LV]

Value: 3

When the undervoltage protection function is active, that is, when DC bus voltage is below the undervoltage

detection level, an ON signal is output. After the voltage is restored and becomes higher than the undervoltage detection level, the signal is turned off. The ON signal is output also during activation of the undervoltage protection function.

Undervoltage detection level: About 200 Vdc

Torque polarity [B/D]

Value: 4

The polarity of the torque is calculated inside the drive and output.

When the calculated torque is driving torque, an OFF signal is output, and when it is braking torque, an ON signal is output.

Torque limiting [TL]

Value: 5

When the torque limit function is set a torque limiting signal is output to indicate an excessive load.

The ON signal is output during torque limit, regeneration avoidance operation and current limit.

A stall prevention function automatically operates to change the output frequency at this time.

Restart after momentary power failure [IPF]

Value: 6

Momentary power failure, start-up of restart mode after momentary power failure, and automatic synchronization and recovery are reported through this function.

When the power is recovered and synchronization starts after a momentary power failure, an ON signal is output. The signal changes to an OFF signal after the previous running frequency is achieved.

Completion of restart is assumed at the time of power recovery, and the signal is turned off after this timing. (Refer to the description for F14.)

Overload early warning [OL]

Value: 7

An overload early warning level before the thermal protection trip (electronic thermal overload relay) of the motor energizes.

Either the electronic thermal overload forecast or output current overload forecast can be selected for this overload signal.

For setting refer to Overload early warning (Operation selection) (E33) and Overload early warning (Operation level) (E34).

Note: This function is effective only for motor 1.

Life time alarm [LIFE]

Value: 8

Main bus capacitors life judgement output.

Refer to section 8-2 (1) "Capacity measurement of main circuit capacitor" for description.

Frequency level detection 2 [FAR2]

Value: 9

This is a frequency level detection (detection width) signal where function code E29 "Frequency level detection delay" takes effect. Detection level of the frequency is at the output and before the torque limiter.

E29 Frequency level detection delay

Setting range: 0.01 to 10.0 s

The delay is valid only for FAR2 and it can be adjusted between 0.01 and 10.0 seconds. The hysteresis can be adjusted in a range of 0 to +/-10 Hz of the output frequency.

E30 FAR function signal (Hysteresis)

Setting range: 0.0 to 10.0 Hz

Adjust the hysteresis and signal output delay for the output frequency.

The output frequency changes according to the torque limiting operation. When the frequency exceeds the setting range (width), the signal is turned off in a mode (FAR: E20, 21 set to "1") or it is not turned off in another mode (FAR2: E20, 21 set to "9").

An ON signal can be output from the terminal within the detection range (width).

E31 FDT function signal (Level)

E32 FDT function signal (Hysteresis)

E 3 1
E 3 2

Setting range: (Operation level): 0 to 400 Hz
(Hysteresis width): 0.0 to 30.0 Hz

Determines the operation (detection) level of the output frequency and the hysteresis width for operation. When the output frequency exceeds the set FTD operation level, an ON signal can be output from the terminal.

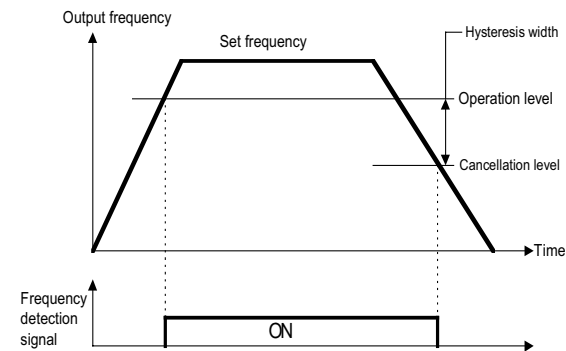

E33 OL function signal (Mode select)

E 3 3

Setting: 0 Electronic thermal overload relay
1 Output current

The OL function signal includes two variations: "overload forecast by means of the electronic thermal overload relay" and "overload forecast by means of output current".

Setting	Function	Outline
0	Electronic thermal overload relay	Overload forecast using the characteristics of the electronic thermal overload relay which show inverse time limit characteristics against the output current. The operation selection of the inverse time limit characteristics and the thermal time constant are the same characteristics as those of the electronic thermal overload relay (F10, F12) for motor protection. To use for a forecast, set at a lower level than the electronic thermal overload relay for motor protection.
1	Output current	When the output current exceeds the set current for a period longer than the set time, an overload forecast is issued.

E34 OL function signal (Level)

E 3 4

Setting range:

Rated drive output current x (20 to 200%)

Determines the level of the electronic thermal overload relay or output current. The operation cancellation level is 90% of the set value.

E35 OL function signal (Timer)

E 3 5

Setting range: 0.1 to 60.0 s

When E33 “OL function signal (Mode select)” is set at “1” (output current), this sets the time taken until the output is initiated.

E40 Display coefficient A

E41 Display coefficient B

E 4 0 E 4 1

Setting range

Display coefficient A: 0.00 to 200.0

Display coefficient B: 0.00 to 200.0

Use these functions as conversion coefficients for determining the displayed value (process amount) of the load speed, line speed and target value and feedback amount of the PID loop.

Load speed and line speed. Use E40 “Display coefficient A”.

- (Displayed value) = (Output frequency) x (0.01 to 200.0)
The effective value of the display data is 0.01 to 200.0. Therefore the display is limited by the minimum value of 0.01 and the maximum value of 200.0 even if the value exceeds the range.
- Target value and feedback amount of PID loop:
Set the maximum value of the displayed data at E40 “Display coefficient A” and set the minimum value at E41 “Display coefficient B”.
Display value = (Target value or feedback amount) x (Display coefficient A - B) - B

Displayed value

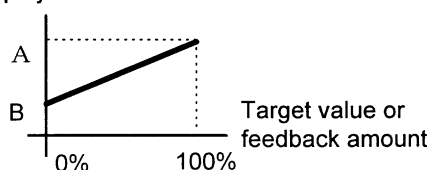

E42 LED display filter

E 4 2

Setting range: 0.0 to 5.0 s

The data available to the “LED monitor” includes data that changes rapidly. This type of data can be displayed with a filter to suppress.

The target display items are the output current and output voltage.

C: Control Functions of Frequency

C01 Jump frequency 1

C02 Jump frequency 2

C03 Jump frequency 3

C04 Jump frequency hysteresis

These functions jump the output frequency to avoid the loads mechanical resonance points.

- Three jump frequencies can be set.
- This function is inactive when all the jump frequencies 1 through 3 are set at 0 Hz.
- The frequencies are not jumped during acceleration or deceleration.

If the setting ranges of jump frequencies overlap, the sum of the setting ranges is jumped.

C01 C02 C03 (Jump Frequencies)

C 0 1
C 0 2
C 0 3

Setting range: 0 to 400 Hz

Minimum unit: 1 Hz

C04 (Hysteresis)

C 0 4

Setting range: 0 to 30 Hz

Minimum unit: 1 Hz

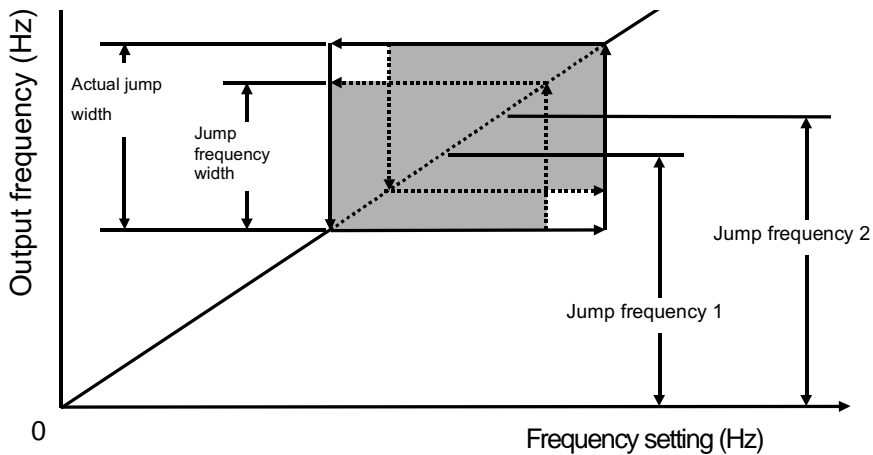
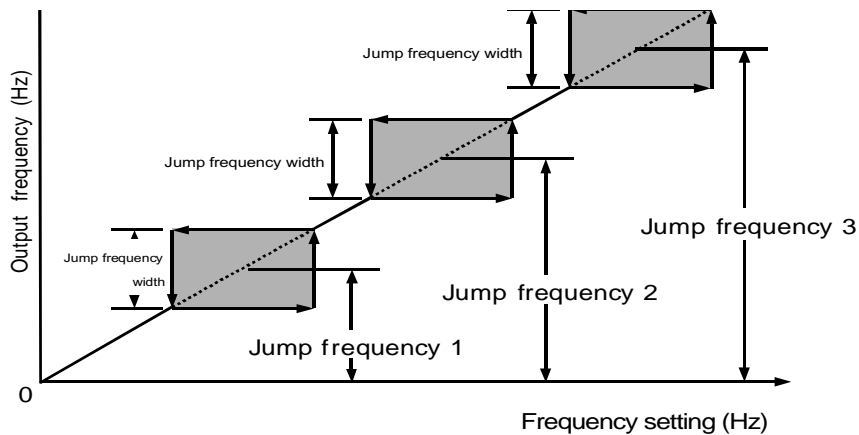

C05-C19 Multistep frequency 1 through 15

C	0	5
C	0	6
C	0	7
C	0	8
C	0	9
C	1	0
C	1	1
C	1	2
C	1	3
C	1	4
C	1	5
C	1	6
C	1	7
C	1	8
C	1	9

Terminal functions SS1, SS2, SS4 and SS8 are turned on or off to switch multistep frequencies 1 through 15. (Refer to E01 through E05 for the definition of the terminal function.)

Undefined terminals among terminal functions SS1, SS2, SS4 and SS8 are assumed to be turned off.

Setting range: 0.00 to 400.0 Hz

Minimum unit: 0.01 Hz

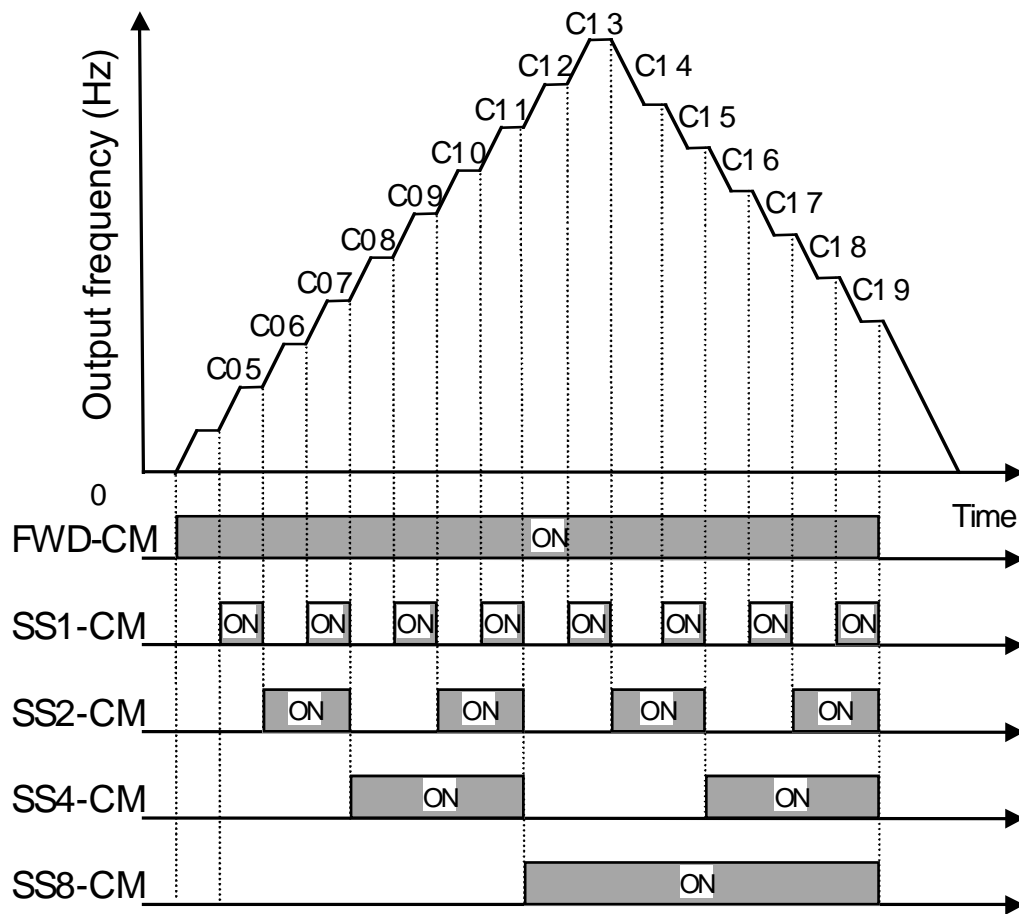

C21 Timer operation

C 2 1

Select active or inactive timer operation.

0: Inactive timer operation

1: Active timer operation

C22 Timer duration

C 2 2

Setting range: 0.00 to 3600 s

A timer operation from the start of operation to automatic stop can be created.

Set the time from the start of operation to automatic stop.

Note: If the power is turned off or the drive is stopped or trips during timer operation, the counted time is reset.

C30 Frequency command 2

C 3 0

Select the frequency setting method.

For the selectable frequency setting methods, refer to the description of F01.

C31 Analog signal offset adjustment (Terminal 12)

C32 Analog signal offset adjustment (Terminal C1)

C 3 1 C 3 2

Sets the offset on the analog input (terminal [12], or terminal [C1]).

The offset can be set in the range between -5.0% and + 5.0% of the maximum output frequency (in 0.1% step).

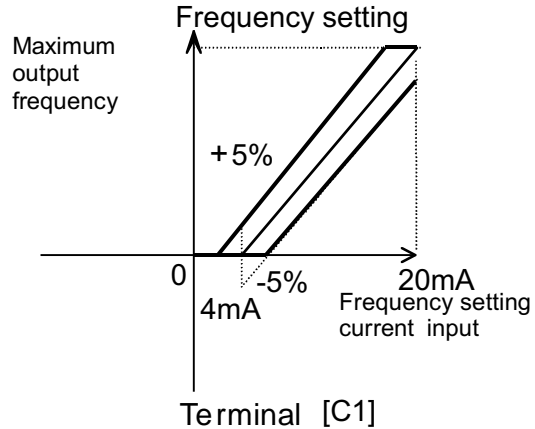
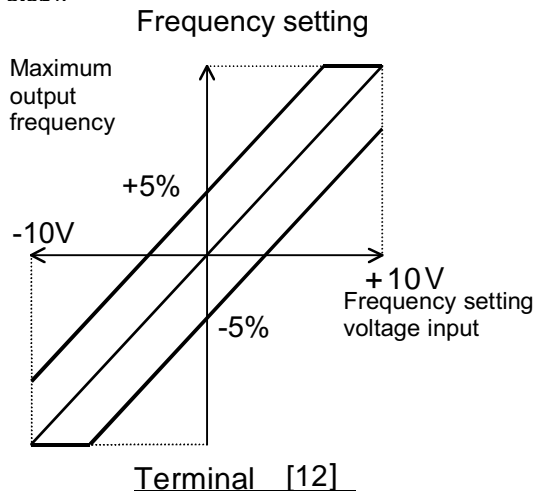

C33 Analog signal filter

C 3 3

Setting range: 0.00 to 5.00 s

The analog signal supplied to control terminal 12 or C1 sometimes includes electric noise. Electric noise may make the control unstable. Adjust the time constant of the input filter to remove the effects of electrical noise.

With a large time constant (setting), the drive becomes stable but there is a delay in the drive response. With a small time constant, the response is quicker, but if the signal has electrical noise, the drive's output varies and can become unstable.

If the adjustment has been determined change the setting when the drive is unstable, or the response is slow.

Note) The function applies to both terminals [12] and [C1] (in common). However, when a PID feedback signal is input, H25 "PID control feedback filter" is applied.

P: Motor parameters

P01 Number of motor 1 poles

P 0 1

Setting range: 2, 4, 6, 8, 10, 12 or 14

This function sets the number of poles in Motor 1. A correct value is needed to display correct motor speeds (synchronous speeds) on the keypad LED.

P02 Motor 1 (Capacity)

P 0 2

Setting range: 0.01 to 7.5 Hp (5 Hp or smaller)
0.1 to 15 Hp (7.5 to 10 Hp)

A standard motor capacity is set before shipment from the factory. Change the setting when running a motor that is rated other than the standard default motor capacity.

Set the standard motor capacity specified in section 9-1 "Standard Specifications". The setting range should be between one rating higher or two ratings lower from the standard motor capacity. If this range is exceeded, accurate motor speed control may not be possible. If a value between the standard applicable motor capacity and the capacity of another rating is set, the data of the lower capacity is automatically used.

P03 Motor 1 (Rated current)

P 0 3

Setting range: 0.00 to 99.9 A

This parameter sets the rated current of motor 1.

P04 Motor 1 (Tuning)

P 0 4

This function measures and automatically stores motor data.

Setting	State of operation
0	Inactive
1	The primary resistance (%R1) of the motor and the leakage reactance (%X) at the base frequency are measured while the motor is stopped and the data is automatically written to P07 and P08.
2	The primary resistance (%R1) of the motor and the leakage reactance (%X) at base frequency are measured while the motor is stopped, then the no-load current (I _o) is measured while the motor turns and P06, P07 and P08 are automatically re-programmed.

Perform an auto tuning if the P06, P07 and P08 data written in the inverter differs from the actual motor data. For example:

- When additional impedance on the output cannot be ignored, such as a long wire runs between the inverter and the motor or connection of a output reactor.
- When %R1 or %X is unknown due to a nonstandard or special motor.

Tuning Procedure:

1. Adjust the voltage and frequency according to the characteristics of the motor. Adjust "F03", "F04", "F05" and "F06".
2. Enter the motor constants which cannot be tuned; P02 "Capacity", P03 "Rated current", P06 "No-load current" (The no-load current is not necessary in tuning mode 2, that is P04 = 2)
3. To tune for no-load current, disconnect the motor from the machine. Check that no danger occurs when the motor turns.
4. Set P04 "Tuning" to "1" (no motor rotation) or "2" (motor rotation) and press the FUNC/DATA key, then issue an operation command (press the RUN key or turn the FWD or REV terminal on) to start tuning. Tuning takes several seconds to several minutes. When "Tune -2" is used, the motor accelerates to half of base frequency in the set acceleration time then decelerates. The time necessary for tuning varies according to the set acceleration/deceleration time.

- During tuning, the tuning parameter (“1” or “2”) blinks rapidly. When tuning is complete the next function code (P05) is displayed. If the FWD or REV terminal board input is used to start tuning, disconnect them at the end of the tune.

Note: Turn the BX and RST terminals off if used, before starting the tuning.

WARNING

If auto tuning is set at “2”, the motor turns at half of the base speed. Make sure that the motor is disconnected from the mechanical machine and that no danger results from the rotation. **Injuries may result.**

P05 Motor 1 (Online tuning)

P 0 5

The motor temperature changes after long operation, which changes the motor speed. Use online tuning to reduce the speed fluctuation caused by temperature changes of the motor.

Setting	State of operation
0	Inactive
1	Active

P06 Motor 1 (No-load current)

P 0 6

Setting range: 0.00 to 99.9 A

This parameter is the no-load current (magnitizing current) of motor 1.

P07 Motor 1 (%R1 setting)

P08 Motor 1 (%X setting)

P 0 7 P 0 8

Use these parameters when the impedance between the drive and motor and the motor itself are known.

Calculate %R1 in the following formula.

$$\%R1 = \frac{R1 + \text{Cable R}}{V / (\sqrt{3} \cdot I)} \times 100 [\%]$$

Where R1: Resistance of the single phase, primary coil of the motor [ohm].

Cable R: Resistance of the single phase output cable. [ohm]

V: Rated voltage [V]

I: Rated motor current [A]

Calculate %X in the following formula.

$$\%X = \frac{X1 + X2 \cdot XM / (X2 + XM) + \text{cable X}}{V / (\sqrt{3} \cdot I)} \times 100 [\%]$$

where

X1: Primary leakage reactance of the motor [ohm]

X2: Secondary leakage reactance of the motor (converted to primary reactance) [ohm]

XM: Motor excitation reactance [ohm]

Cable X: Reactance of the output cable [ohm]

V: Rated voltage [V]

I: Rated motor current [A]

Note: Use the reactance specified at F04 “Base frequency 1”.

Add the value for a reactor and filter connected to the output of the drive. If the cable value can be ignored, the cable value should be “0”.

P09 Motor 1 (Slip compensation control 1)

P 0 9

Setting range: 0.00 to 15.00 Hz

When the load torque changes, the motor slip changes and the motor speed fluctuates. With the slip compensation control, a frequency proportional to the motor load is added to the output frequency of the drive. This minimizes the fluctuation of the motor speed caused by this torque change.

Calculate the slip compensation data in the following formula.

Slip compensation amount =

$$\text{Base frequency} \times \frac{\text{Slip r/min}}{\text{Synchronous speed [r/min]}} \quad [\text{Hz}]$$

P10 Motor 1 (Slip compensation response time 1)



This function sets the response time for slip compensation.











Note: With a low setting, the response time becomes shorter, but regeneration may cause overvoltage tripping with some loads.

H01 Total operation time

The total power-on time of the drive is displayed. A number between 0 and 6500 is displayed, indicating 0 to 65000 hours. (The time is displayed in tens of hours, though the drive counts each hour. Time shorter than one hour is not counted.)

H02 Trip history

A history of the latest four faults is stored in memory. To call up each event, press the  or  key.

	Call up	Display example	Remarks
1	H 02	H 02	
2	 ↓ ↑ 	1.0U2	The latest protective operation is displayed.
3	↓  ↓ ↑ 	2.0H1	The protective operation before the previous one is displayed.
4	↓  ↓ ↑ 	3.0C1	The protective operation before the two previous ones is displayed.
5	↓  ↓ ↑ 	4.-- --	The protective operation before the three previous ones is displayed.
6	↓  ↘ ↑ 	END	

A new fault is stored in the latest location, and the previous records are shifted up, one by one. Oldest faults are deleted.



H03 Data initializing(Data reset)

H 0 3

Setting 0: Function stop

1: Initialize to factory defaults

This function restores (initializes) the factory data settings and writes over changes made by the user.

Press the  and  keys simultaneously to change the setting to "1", then press the  key to initialize the settings. After initialization is completed, parameter setting automatically returns to "0".

H04 Auto-reset(Times)

H05 Auto-reset (Reset interval)

When a fault is activated, operation of the drive protective function is canceled and the drive automatically restarts and no alarm occurs.

H 0 4

Setting range: 0 to 10 (0: retry inactive)
number of fault resets attempted.

Setting range: 2 to 20 s

Sets the wait time from activation of a fault to resetting.

Drive faults that can be "auto-reset" are:

OC1, OC2, OC3	Overcurrent
OU1, OU2, OU3	Overvoltage
OH1	Overheated heat sink
dbH	Overheated damping resistor
OL1	Overloaded motor 1
OL2	Overloaded motor 2
OLU	Overloaded inverter

When the value of H04, Auto-reset (Times) is set from 1 to 10, retry operation starts and the time set in H05, "Reset interval" elapses, the drive start command is automatically input. If the cause of the alarm has been removed, the drive starts without entering the alarm mode. If the cause of the alarm remains, the fault is activated again to wait for the time set at H05 "Retry (Times)". If the cause of the alarm is not removed after the number of repetition cycles set at H04 "Retry (Reset interval)", the drive enters the alarm mode.

WARNING

If the Auto-restart function has been selected, the drive may automatically restart. (The machine should be designed so that human safety is ensured after restarting. **Otherwise an accident could occur.**)

Upon success of retry

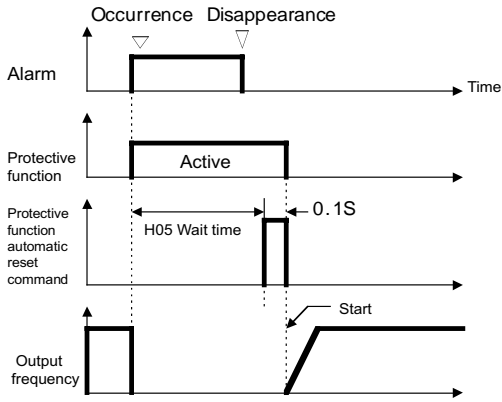

Upon failure of retry

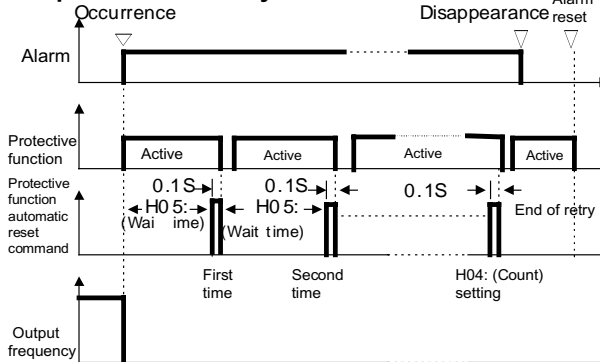

H06 Fan stop operation

H06

Setting 0: On/off control not enabled

1: On/off control

With this function, the temperature of the heat sink is monitored while the drive is turned on, and the cooling fan is automatically turned on and off. If this function is not selected, the cooling fan operates continuously.

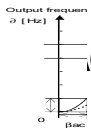

CC/DEC pattern (Mode select)

- Setting 0: Inactive (linear acceleration/deceleration)
 1: S-curve acceleration/deceleration (Weak)
 2: S-curve acceleration/deceleration (Strong)
 3: Non-linear (for variable torque)

Selects the acceleration/deceleration ramp shape.

When the function is set at "1", "2" or "3", a change in the acceleration or deceleration time is not reflected immediately. The setting becomes effective only after a constant speed is reached or the drive is stopped.

Note: 1 and 2 [S-curve acceleration/deceleration]

To reduce shock to the mechanical system, the change in the output frequency is made smooth when the reference is changed.

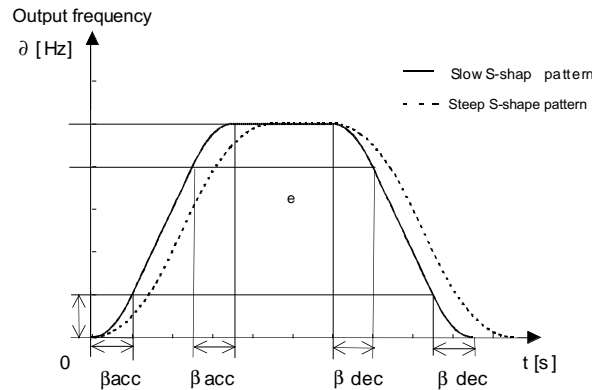

<Constant of each pattern>

	H07=1 (slow S-curve pattern)	H07=2 (steep S-curve pattern)
Range of S-curve(Δ)	0.05 x (Maximum output frequency [Hz])	0.10 x (Maximum output frequency [Hz])
S-curve time during acceleration (β acc)	0.10 x (Acceleration time [s])	0.20 x (Acceleration time [s])
S-curve time during deceleration (β dec)	0.10 x (Deceleration time [s])	0.20 x (Deceleration time [s])

When the acceleration/deceleration time is extremely long or short, the result is linear acceleration/deceleration.

3. [Curved acceleration/deceleration]

This function is used to modify the acceleration/deceleration curve for motor operating above base frequency.

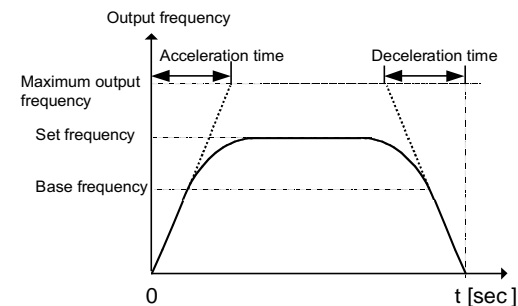

H09 Start mode (Rotating motor pickup)

H 0 9

This function smoothly starts a motor coasting after a momentary power failure.

The speed of the motor is detected upon power recovery and that same frequency is applied to the motor. Therefore the motor starts smoothly without a shock. However, when the coasting speed of the motor exceeds the setting of F03 "Maximum frequency 1" or of F15 "Frequency limiter (High)", the normal starting method is used.

Setting	Regular starting	Restarting after momentary power failure
0	Inactive	Inactive
1	Inactive	Active
2	Active	Active

Description of setting

- 1: This function is effective when the value of F14 "Restart after momentary power failure (Operation selection)" is "2" or "3".

Starting is attempted at the same frequency as the rotating motor.

- 2: Upon restart, after momentary power failure, the speed of the coasting motor is detected and starting is made at the same frequency as that for the coasting motor.

Note: When this function is used, use the following settings to determine the speed of the motor.

1. Set F09 Torque boost to "0" (automatic torque boost).
2. Perform autotune (P04).

H10 Energy-saving operation

H 1 0

Setting 0: Inactive
1: Active

When the output frequency is constant (constant speed operation) and the load is light, and the setting of F09 "Torque boost 1" is other than "0", the output voltage is automatically lowered to minimize the power output.

Notes:

1. Use this function for fans or pumps only. If this function is applied to a constant torque load or to an application with a rapidly changing load, there will be a delay in the control response.

2. The energy-saving operation is automatically canceled during acceleration or deceleration or when the torque limiter function is activated.

H11 Dec mode

H 1 1

Setting 0: Normal
(Deceleration to stop based on the value of H07 "ACC/DEC pattern")
1: Coast-to-stop

This function determines the stopping method of the drive after a stop command is entered.

Note: This function is not activated when the set frequency is set to zero. The function is activated only when a stop command is entered.

H12 Instantaneous overcurrent limiting

H 1 2

Setting 0: Inactive
1: Active

An overcurrent trip generally occurs when current flows above the drive protective level, following a rapid change in motor load. The instantaneous overcurrent limiting function controls drive output and prohibits the flow of a current exceeding the protective level, even if the load changes.

Since the operation level of the instantaneous overcurrent limiting function cannot be adjusted, the torque limiting function must be used.

Motor generation torque may be reduced when instantaneous overcurrent limiting is applied. Set this function to be inactive for equipment such as elevators, which are adversely affected by reduced motor generation torque, in which case an overcurrent trip occurs when the current flow exceeds the drive protective level. A mechanical brake should be used to ensure safety.

H13 Auto-restart (Restart time)

H 1 3

Setting range: 0.1 to 5 seconds

Instantaneous switching to another power line (when the power of an operating motor is cut off or power failure occurs) creates a large phase difference between the line voltage and the voltage remaining in the motor, which may cause electrical or mechanical failure. To rapidly switch power lines, set the voltage attenuation time to wait for the voltage remaining in the

motor to decay. This function operates at restart after a momentary power failure.

If the momentary power failure time is shorter than the wait time value, a restart occurs following the wait time. If the power failure time is longer than the wait time value, a restart occurs when the drive is ready to operate (after about 0.2 to 0.5 seconds).

H14 Auto-restart (freq. fall rate)

H 1 4

Setting range: 0.00, 0.01 to 100.00 Hz/s

If H14 = 0.00, the frequency is reduced according to the set deceleration time.

This function determines the reduction rate of the output frequency for synchronizing the drive output frequency with the motor speed. This function is also used to reduce the frequency and thereby prevent stalling under a heavy load during normal operation.

Note: A frequency reduction rate that is set too large may temporarily increase the regeneration energy from the load and invoke the overvoltage protective function. Conversely, a rate that is too small extends the operation time of the current limiting function and may invoke the drive overload protective function.

H20 PID control (mode select)

- Set value
- 0: No operation
 - 1: Normal operation
 - 2: Inverse operation

PID control detects the amount of feedback from a sensor and compares it with the target value (e.g., reference temperature). If the values differ, this function produces an output to eliminate the deviation. In other words, this control matches the feedback amount with the target value.

This function can be used for flow control, pressure control, temperature control, and other process controls.

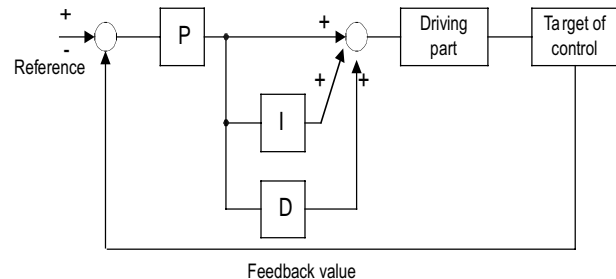

Forward or reverse operations can be selected for PID controller output. This enables motor revolutions to be faster or slower according to PID controller output.

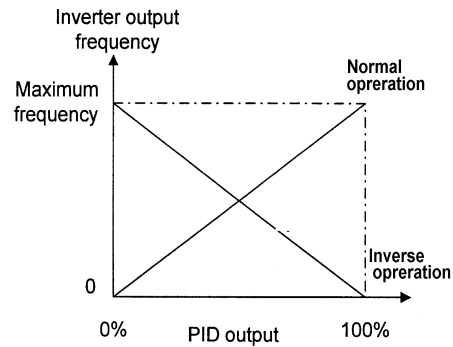

The target value can be entered using F01, Frequency setting 1, or directly from the keypad panel.

For entry from F01, Frequency setting 1, input a signal to the selected terminal. For direct entry from the keypad panel, turn on keypad operation. Select any of the digital Terminals X1 (E01) to X9 (E09) and assign a value of 11 (frequency setting switching).

Note: For the target value and feedback amount, the process amount can be displayed according to the values set in E40 Display coefficient A, and E41 Display coefficient B.

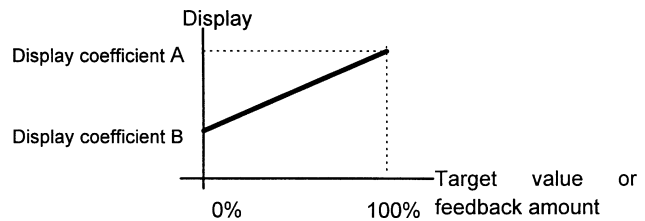

H21 PID control (feedback signal)

H 2 1

This function selects the terminal, direction of operation, and feedback input. Select a value from the table below according to sensor specifications.

Value	Description
0	Terminal 12, forward operation, 0 to 10V voltage input
1	Terminal C1, forward operation, 4 to 20mA current input
2	Terminal 12, reverse operation, 10 to 0V voltage input
3	Terminal C1, reverse operation, 20 to 4mA current input

Only positive values can be input for this feedback amount of PID control. Negative values (e.g., 0 to -10V, -10 to 0V) cannot be input, thereby the function cannot be used for a reverse operation by an analog signal.

Feedback signal setting (H21) must be different from the type of setpoint value.

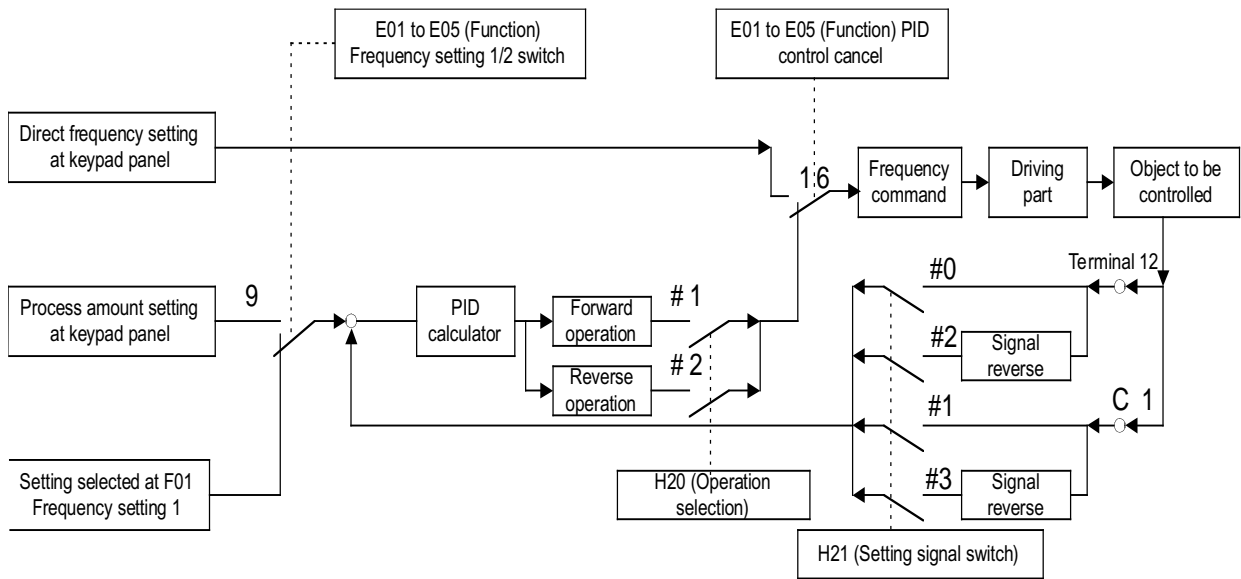
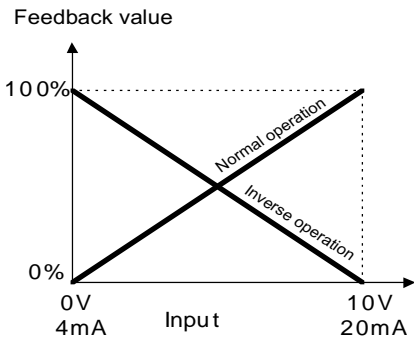

Note: Numbers marked # indicate the the feedback options of H21

H22 PID control (P-gain)

These functions are not generally used alone but are combined like **P** control, **PI** control, **PD** control, and **PID** control.

P operation

An operation using an output frequency proportional to deviation is called **P** operation, which outputs an operation amount proportional to deviation, though it cannot eliminate deviation alone.

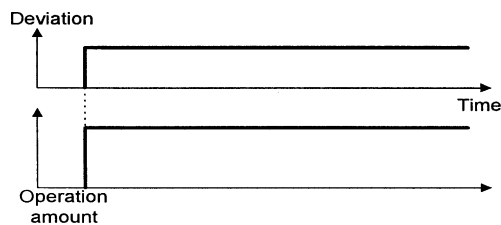

H 2 2

Setting range: 0.01 to 10.0 times

P (gain) is the parameter that determines the response

level for the deviation of **P** operation. Although an increase in gain speeds up response, an excessive gain

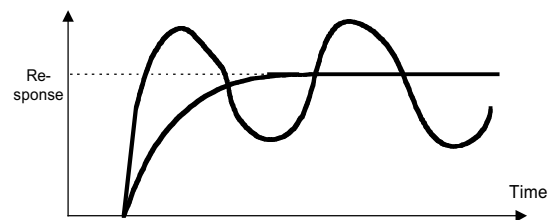

H23 PID control I (integral time)

I operation

An operation where the change speed of the output frequency is proportional to the deviation is called an **I** operation. An **I** operation outputs an operation amount as the integral of deviation and, therefore, has the effect of matching the feedback control amount to the target value (e.g., set frequency), though it deteriorates response for significant changes in deviation.

H 2 3

Setting range: 0.0 (Inactive), 0.1 to 3600 seconds
H23 I-gain is used as a parameter to determine the effect of I operation. A longer integration time delays response and weakens resistance to external elements. A shorter integration time speeds up response, but an integration time that is too short causes vibration.

H24 PID control (D (Differential time))

D operation

An operation where the output frequency is proportional to the deviation differential is called a D operation. It outputs an operation amount as the deviation differential and, therefore, is capable of responding to sudden changes.

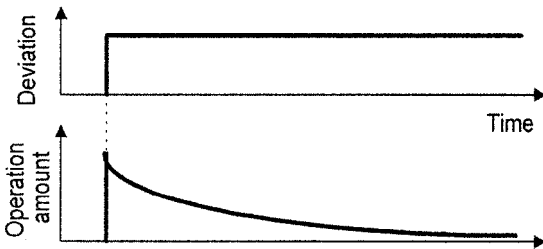

H 2 4

Setting range: 0.00 (Inactive), 0.01 to 10.0 seconds
H24 D-gain is used as a parameter to determine the effect of a D operation. A longer differentiation time causes vibration by P operation quickly attenuating at the occurrence of deviation. Excessive differentiation time could cause vibration. Shortening the differentiation time reduces attenuation at the occurrence of deviation.

PI control

P operation alone does not remove deviation completely. P + I control (where I operation is added to P operation) is normally used to remove the remaining deviation. PI control always operates to eliminate deviation, even when the target value is changed or there is a constant disturbance. When I operation is strengthened, however, the response for rapidly changing deviation deteriorates. P operation can also be used individually for loads containing an integral element.

PD control

If deviation occurs under PD control, an output frequency larger than that of D operation alone occurs

rapidly and prevents the deviation from expanding. For a small deviation, P operation is restricted. When the load contains an integral element, P operation alone may allow responses to vibrate due to the effect of the integral element, in which case PD control is used to attenuate the vibration of P operation and stabilize responses. In other words, this control is applied to loads in processes without a braking function.

PID control

PID control combines the P operation, the I operation which removes deviation, and the D operation which suppresses vibration. This control achieves deviation-free, accurate, and stable responses.

H 2 5 PID control (Feedback filter)

Setting range: 0.0 to 60.0 s

This function provides a filter for the feedback signal input at terminal 12 or C1. The filter makes the operation of the PID control system stable. However, an excessively large setting causes a poor response.

H 2 6 PTC thermistor (Mode select)

Setting 0: Inactive
1: Active

This function is used for a motor equipped with a PTC thermistor for overtemperature protection. Connect the PTC thermistor as shown in the figure. The protective operation is common with the external alarm input. Therefore this protective function operates as the "external alarm".

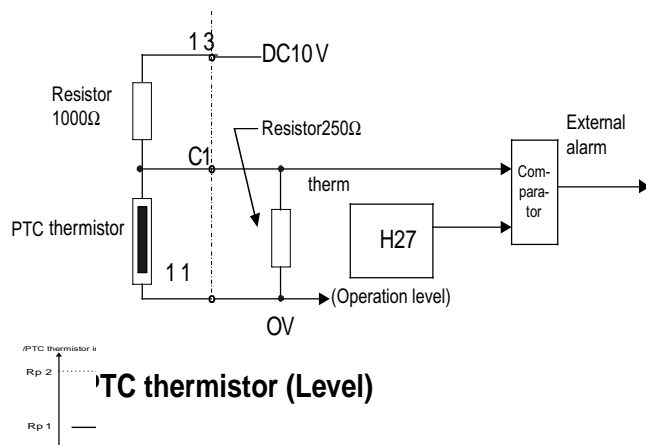

The voltage input at terminal [C1] is compared with the set voltage and, when the input voltage at terminal [C1] is larger than the set voltage (operation level), H26 “PTC thermistor (Operation selection)” is activated. Setting range: 0.00 to 5.00 V (The set values lower than 0.10 are handled as 0.10.)

The alarm temperature is determined by the PTC thermistor and its internal resistance. The thermistor resistance changes greatly at the alarm temperature. Use this characteristic to set the voltage level to be used.

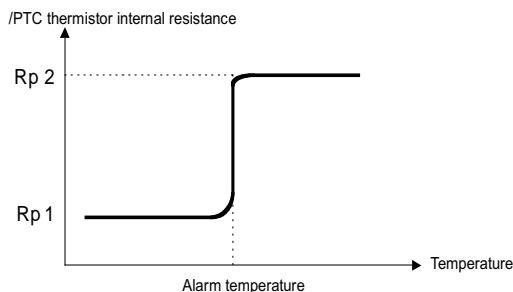

The figure for H26 PTC thermistor (Mode select) shows that a 250W resistor and the thermistor (resistance value Rp) are connected in parallel. Hence, voltage Vc1 at Terminal C1 can be calculated using the following formula:

$$V_{c1} = \frac{250 \cdot R_p}{250 + R_p} \times 10 \text{ [V]}$$

$$1000 + \frac{250 \cdot R_p}{250 + R_p}$$

The operation level can be set by bringing Rp in the Vc1 calculation formula into the following range.

$$R_{p1} < R_p < R_{p2}$$

To calculate Rp, use the following formula:

$$R_p = \frac{R_{p1} + R_{p2}}{2} \text{ [Ohm]}$$

H28 Droop operation

H 2 8

Set value : -9.9Hz to 0.0Hz

When two or more drive motors operate a single machine, a higher load is placed on the motor that is rotating the fastest. Droop operation achieves a good load balance by applying drooping characteristics to speed against load variations.

Calculate the droop amount using the following formula:

$$\text{Droop amount} = \text{Base frequency} \times \frac{\text{Speed droop at rated torque [r/min.]} \text{ [Hz]}}{\text{Synchronous speed [r/min.]}}$$

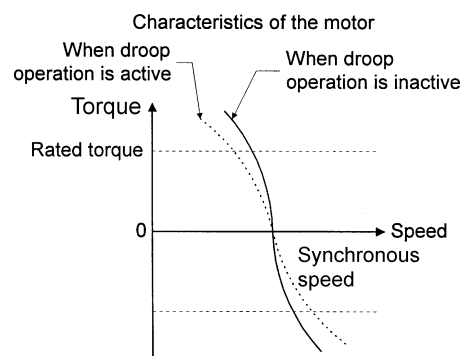

H30 Serial link (Function select)

Setting range: 0 to 3

RS485 Modbus RTU (standard accessory) can be connected as a field bus connection (communication function).

As a field bus function, the following items are possible.

- 1) Monitoring (monitoring of various data, confirmation of function code data)
- 2) Frequency setting
- 3) Operation command (FWD, REV and other commands set for digital input)
- 4) Function code data writing

The monitor function and function code data writing function are always valid. When the communication is disabled by means of a digital input, a state similar to setting “0” is obtained.

H31 RS485 (address) through

This function sets the various conditions of RS485 communication. It must be set according to the specifications of the host unit. Refer to section 9-4 for protocol and other specifications.

The mode of communication can be switched by a digital input. Mode settings are available through the communications link.

Setting	Frequency setting	Operation command
0	Invalid	Invalid
1	Valid	Invalid
2	Invalid	Valid
3	Valid	Valid

H 3 1

This function sets the station address of RS485.
Setting range: 0 to 247 (0: Broadcast, 1 to 247 Query)

H32 RS485 (Mode select on no response error)

H 3 2

This function sets the communication error handling process and the error handling timer value.
Setting range: 0 to 3

Setting	Communication error handling process
0	Immediate Er 8 trip (forced stop)
1	Operation continues until the timer elapses, then Er 8 trip.
2	Operation continues and retry is made until the timer elapses, then Er 8 trip upon a communication error or continued operation if no communication error.
3	Operation continues.

H33 RS485 (Timer)

H 3 3

This function sets the error handling timer value.
Setting range: 0.0 to 60.0 s

H34 RS485 (Baud rate)

H 3 4

This function sets the transmission speed.

Setting	Transmission speed
0	1 9 2 0 0 bit/s
1	9 6 0 0 bit/s
2	4 8 0 0 bit/s
3	2 4 0 0 bit/s

H35 RS485 (Data length)

H 3 5

This function sets the data length.

Setting	Data length
0	8 bits

H36 RS485 (Parity check)

H 3 6

This function sets the parity bit.

Setting	Parity bit
0	None
1	Even
2	Odd

H37 RS485 (Stop bits)

H 3 7

This function sets the stop bit.

Setting	Stop bit
0	2bits
1	1bit

H38 RS485 (No response error detection time)

H 3 8

Setting range: 0 (no detection)
1 to 60 seconds

In a system where there is always an access to the station at certain intervals, no access caused by broken wire or other errors is detected and the drive trips in Er8.

H39 RS485 (Response interval)

H 3 9

Setting range: 0.00 to 1.00 s

This function sets the time taken until a response is sent back to the host unit after a request.

H40 Maximum temperature of heat sink

The maximum value in each hour is displayed.

H41 Maximum effective current

The maximum value in each hour is displayed.

H42 Main circuit capacitor life

The capacity of the capacitors in the DC Bus is displayed in %. For the measuring conditions, refer to section 8-2 (1) "Measurement of capacitance of capacitor in main circuit".

H43 Cooling fan operation time

Integral hours is displayed. The displayed time is 0 to 6500, indicating 0 to 65000 hours. (Though the displayed value is in ten hours, the drive adds each hour. Operation shorter than one hour is not counted.)

H44 Drive ROM version

The revision of the software in the drive is displayed.

H45 Keypad panel ROM version

The revision of the software in the keypad panel is displayed.

H46 Option ROM version

For drives with optional equipment, the revision of the optional software is displayed.

A: Alternative motor parameters

A01 Maximum frequency 2

A 0 1

The maximum frequency allowed by the drive for motor 2. This parameter functions in the same way as F03 "Maximum output frequency 1". For the description, refer to F03 "Maximum output frequency 1".

A02 Base frequency 2

A 0 2

The output frequency in the constant torque zone of motor 2, that is, the output frequency at the rated output voltage. This parameter functions in the same way as F04 "Base frequency 1". For the description, refer to F04 "Base frequency 1".

A03 Rated voltage 2 (at base frequency 2)

A 0 3

The rated output voltage supplied to motor 2. This parameter functions in the same way as F04 "Rated voltage 1". For the description, refer to F05 "Rated voltage 1".

A04 Maximum voltage 2 (at maximum frequency 2)

A 0 4

The maximum output voltage of the drive for motor 2. This parameter functions in the same way as F06 "Maximum voltage 1". For the description, refer to F06 "Maximum voltage 1".

A05 Torque boost 2

A 0 5

The torque boost function of motor 2. This parameter functions in the same way as F09 "Torque boost 1". For the description, refer to F09 "Torque boost 1".

A06 Electronic thermal overload relay for motor 2 (Select)

A07 Electronic thermal overload relay for motor 2 (Level)

A08 Electronic thermal overload relay for motor 2 (Thermal time constant)

A 0 6
A 0 7
A 0 8

These are the electronic thermal overload relay functions of motor 2. These parameters function in the same way as F10 through F12 Electronic thermal overload relay for motor 1. For the description, refer to F10 through F12.

A09 Torque vector control 2

A 0 9

The torque vector function of motor 2. This parameter functions in the same way as F42 "Torque vector control 1". For the description, refer to F42 "Torque vector control 1".

A10 Number of motor 2 poles

A 1 0

The number of poles of motor 2. This parameter functions in the same way as P01 "Number of motor 1 poles". For the description, refer to P01 "Number of motor 1 poles".

A11 Motor 2 (Capacity)

A 1 1

The capacity of motor 2. This parameter functions in the same way as P02 "Motor 1 (Capacity)". For the description, refer to P02 "Motor 1 (Capacity)". However, the motor data functions are A12 "Motor 2 (Rated current)", A15 "Motor 2 (No-load current)", A16 "Motor 2 (%R1 setting)" and A17 "Motor 2 (%X setting)".

A12 Motor 2 (Rated current)

A 1 2 M 2 - L R

The rated current of motor 2. This parameter functions in the same way as P03 "Motor 1 (Rated current)". For the description, refer to P03 "Motor 1 (Rated current)".

A13 Motor 2 (Tuning)

A 1 3

Tuning of motor 2. This parameter functions in the same way as P04 “Motor 1 (Tuning)”. For the description, refer to P04 “Motor 1 (Tuning)”.

A14 Motor 2 (Online tuning)

A 1 4

Online tuning of motor 2. This parameter functions in the same way as P05 “Motor 1 (Online tuning)”. For the description, refer to P05 “Motor 1 (Online tuning)”.

A15 Motor 2 (No-load current)

A 1 5

The no-load current of motor 2. This parameter functions in the same way as P06 “Motor 1 (No-load current)”. For the description, refer to P06 “Motor 1 (No-load current)”.

A16 Motor 2 (%R1 setting)

A17 Motor 2 (%X setting)

A 1 6 **A 1 7**

%R1 and %X of motor 2. These parameters function in the same way as P07 “Motor 1 (%R1 setting)” and P08 “Motor 1 (%X setting)”. For the description, refer to P07 and P08.

A18 Motor 2 (Slip compensation control 2)

A 1 8

This function sets the slip compensation control of motor 2. This parameter functions in the same way as P09 “Motor 1 (Slip compensation control 1)”. For the description, refer to P09 “Motor 1 (Slip compensation control 1)”.

A19 Motor 2 (Slip compensation response time 2)

A 1 9

This function sets the response time for slip compensation of motor 2. This parameter functions in the same way as P10 “Motor 1 (Slip compensation response time)”. For the description, refer to P10 “Motor 1 (Slip compensation response time)”.

6. Protective Operation

6-1 List of Protective Operations

When an error occurs to the drive, a protective function is activated to trip the drive immediately, displaying the name of the alarm at the LED and allowing the motor to coast to stop.

Table 6-1-1 List of alarm display and protective operations

Name of alarm	Display	Description of operation
Overcurrent protection	OC1	During acceleration
	OC2	During deceleration
	OC3	During constant speed operation
		The protective function is activated when an overcurrent flowing in the motor or a short circuit or ground fault in the output circuit causes the instantaneous drive output current to exceed the overcurrent detection level.
Overvoltage protection	OU1	During acceleration
	OU2	During deceleration
	OU3	During constant speed operation
		The protective function is activated when the regenerative power from the motor increases to cause the DC link voltage of the main circuit to exceed the overvoltage detection level (400 VDC for 230V input, 800 VDC for 460V input). When an excessive voltage is added to the source voltage, the drive trips due to the overvoltage, but drive protection against the overvoltage is impossible.
Undervoltage protection	LU	The protective function is activated when the source voltage drops to cause the DC link voltage in the main circuit to become lower than the undervoltage detection level (200 VDC for 230V input, 400 VDC for 460V input). If F14 Restart after momentary power failure has been selected, no alarm display is given. If the voltage drops below the control power maintenance level, no alarm is displayed.
Input phase loss protection	Lin	If Input power L1/R, L2/S, L3/T has any phase of the 3 phase power "OPEN" or if there is a significant disparity between the phases, the rectifying diodes or smoothing capacitors may be damaged. An alarm is displayed and the protective function is activated.
Heat sink overheat	OH1	The protective function is activated when the temperature of the heat sink of the drive is high because of a broken cooling fan or for other reasons.
External alarm input	OH2	The protective function is activated by a contact signal from an alarm contact of the external device such as the braking unit, braking resistor, and external thermal overload relay connected to the control circuit terminal (THR). Or an overheat protective function is activated by the PTC thermistor.
Braking resistor overheat	dbH	If the electronic thermal overload relay (for braking resistor) has been selected for function code F13, the protective function is activated upon a high operation frequency of the braking resistor to prevent the resistor from being burned due to the temperature rise.
Motor 1 overload	OL1	If electronic thermal overload relay 1 has been selected for function code F10, the protective function is activated by a motor current exceeding the set operation level.
Motor 2 overload	OL2	If motor 2 has been selected and driven and electronic thermal overload relay 2 has been selected for function code A06, the protective function is activated by the current in motor 2 exceeding the set operation level.
Drive overload	OLU	The protective function is activated by an output current exceeding the overload current rating to protect the semiconductor elements in the main circuit of the drive from high temperatures.
Memory error	Er1	The protective function is activated by a data writing error or other errors in the memory.
Keypad panel communication error	Er2	The protective function is activated when a data transmission error or transmission stoppage is detected between the keypad panel and the control section in the keypad panel operation mode.
CPU error	Er3	The protective function is activated by electric noise or other errors developed in the CPU.
Option error	Er4	Error during operation of option
	Er5	
Operating error	Er6	Detects drive operating procedure error during drive startup. FWD or REV connected to terminal CM when Main power is applied to drive (F02 setting 3 or 4). Stop key on keypad is pressed in terminal operation (F02 setting 1 or 3).
Output phase loss	Er7	The protective function is activated during auto tuning when there is a broken wire or no connection in the drive output circuit.
RS485 communication error	Er8	The protective function is activated when a communication error occurs during communication through RS485.

6-2 Alarm Reset

When the drive trips, remove the cause then press the PRG/RESET key on the keypad panel or input a reset command from the RST control terminal to reset the tripping state. Because the reset command is activated by an edge, supply the command in an OFF - ON - OFF sequence as shown in Fig. 6-2-1.

When resetting the tripping state, deactivate the operation command. If the operation command is left turned on, the drive starts operation immediately after the error is reset.

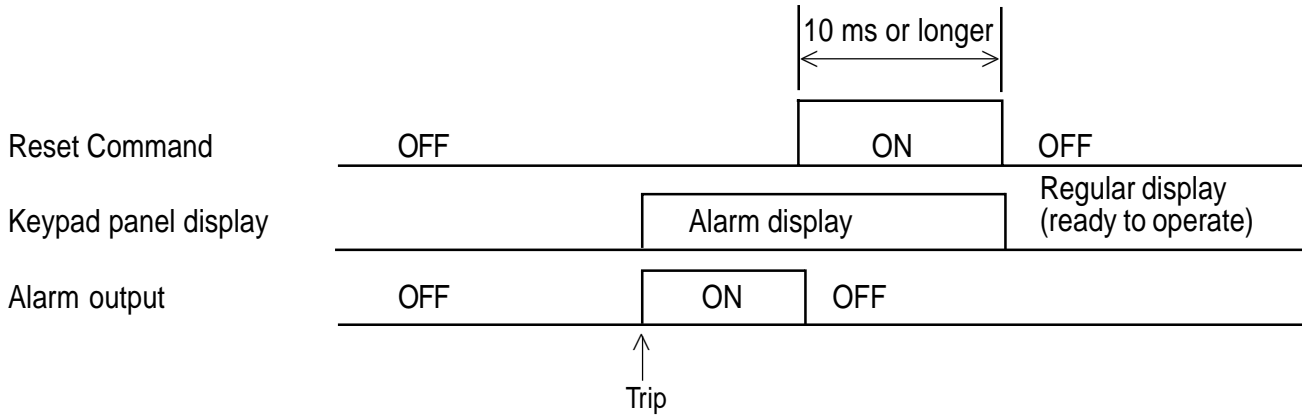

Figure 6-2-1

DANGER

If an alarm reset is made with the operation signal turned on, a sudden start will occur. Check that the operation signal is turned off in advance. **Otherwise an accident could occur.**

7. Troubleshooting

7.1 Protective function activation

(1) Overcurrent

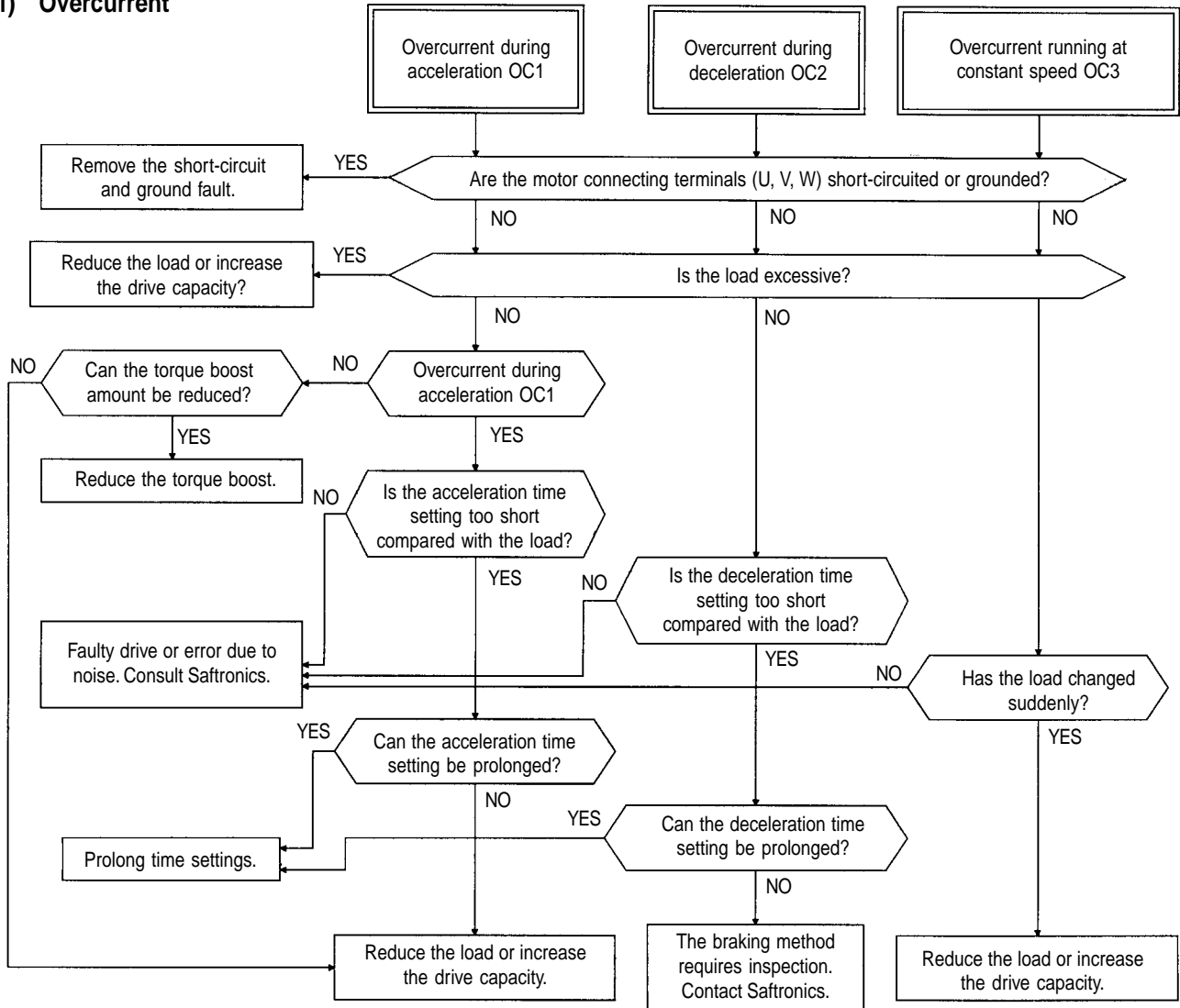

(2) Overvoltage

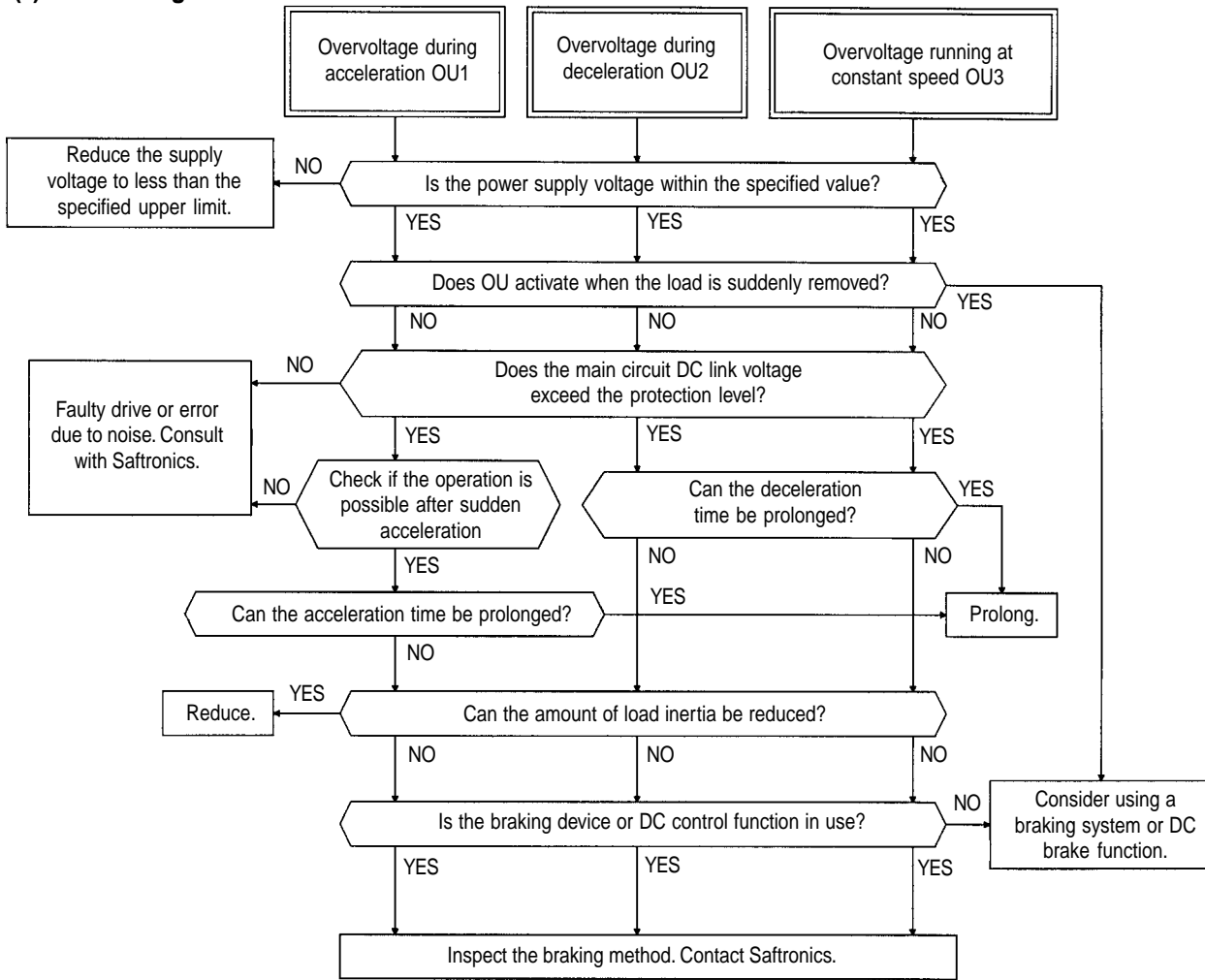

(3) Undervoltage

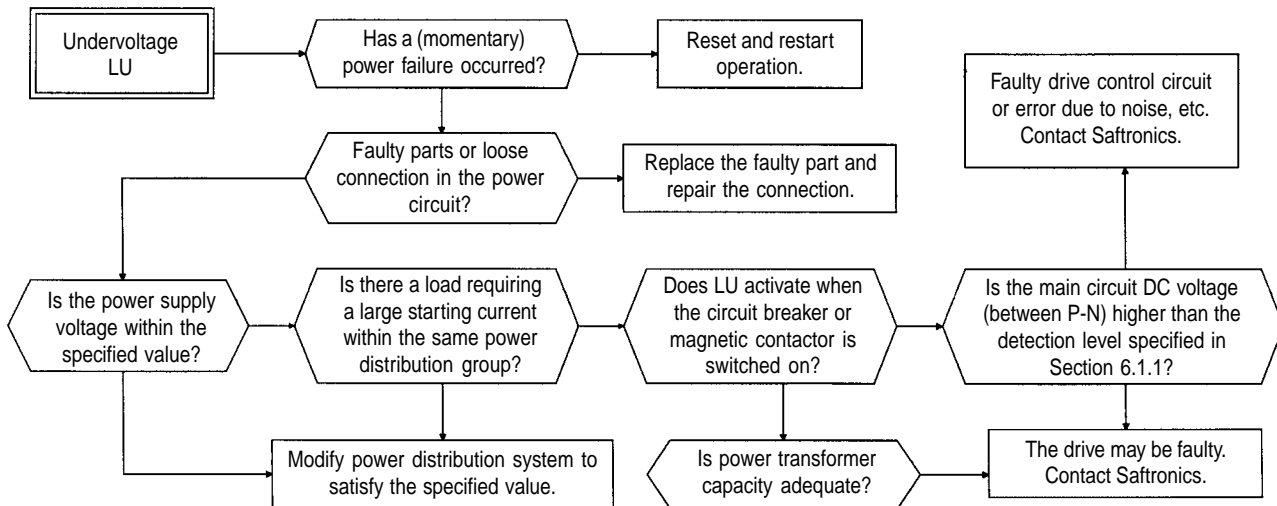

(4) Overheating of heat sink

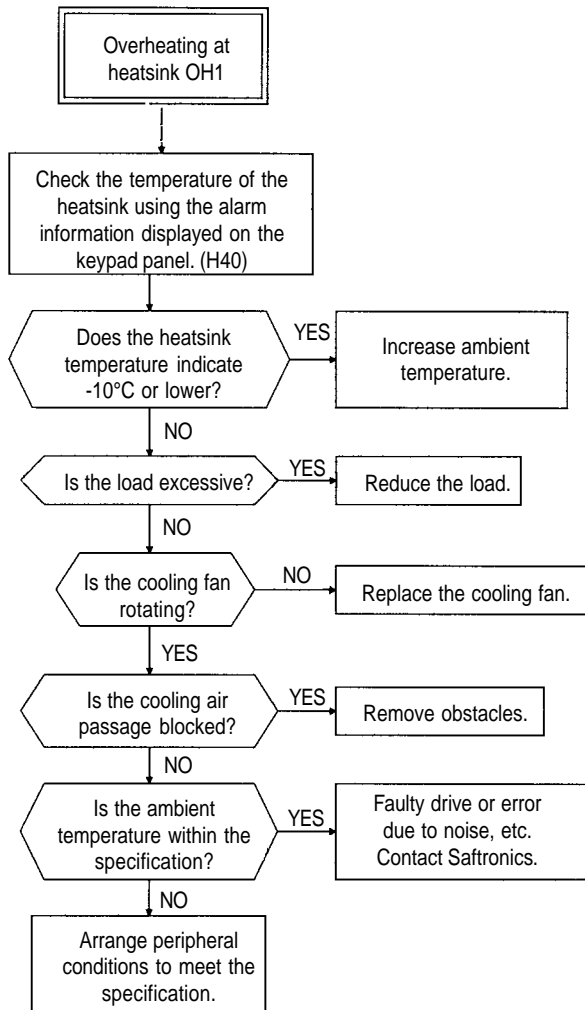

(5) Drive overload and motor overload

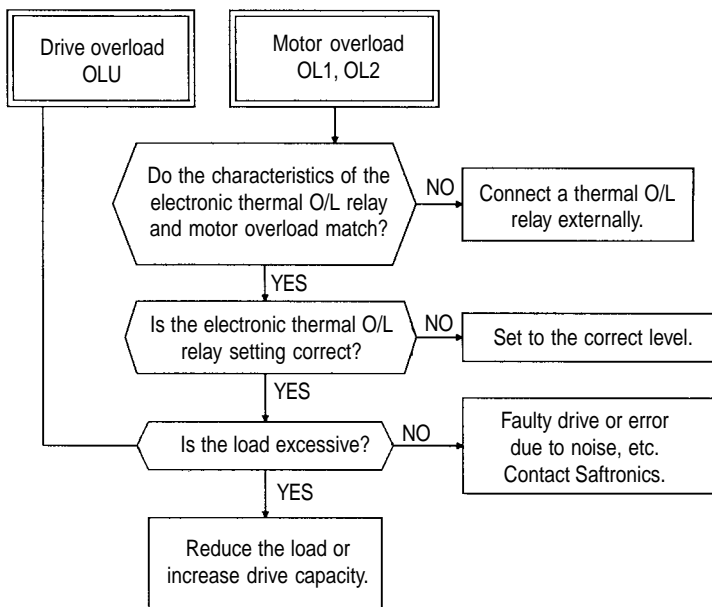

(6) External thermal relay tripped

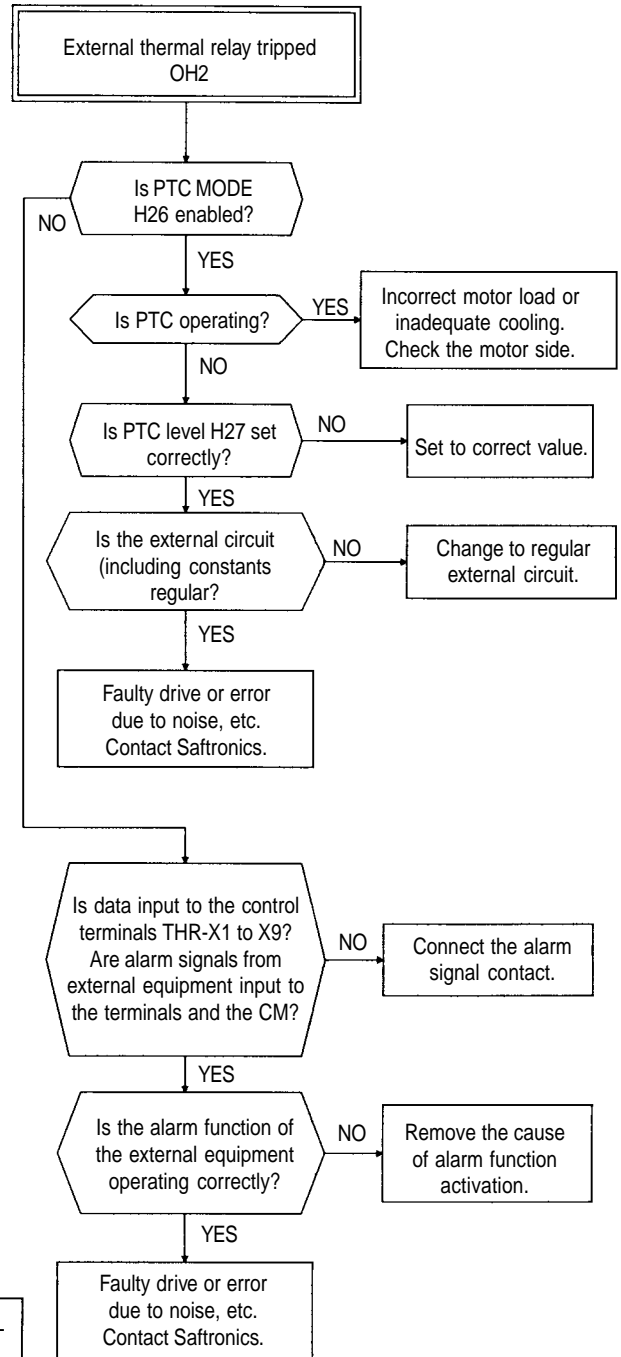

**(7) Memory error Er1,
Keypad panel communication error Er2,
CPU error Er3**

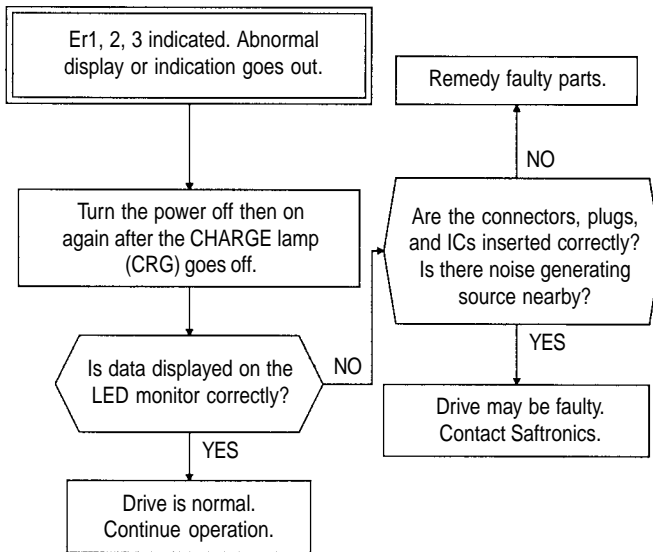

(8) Output wiring error

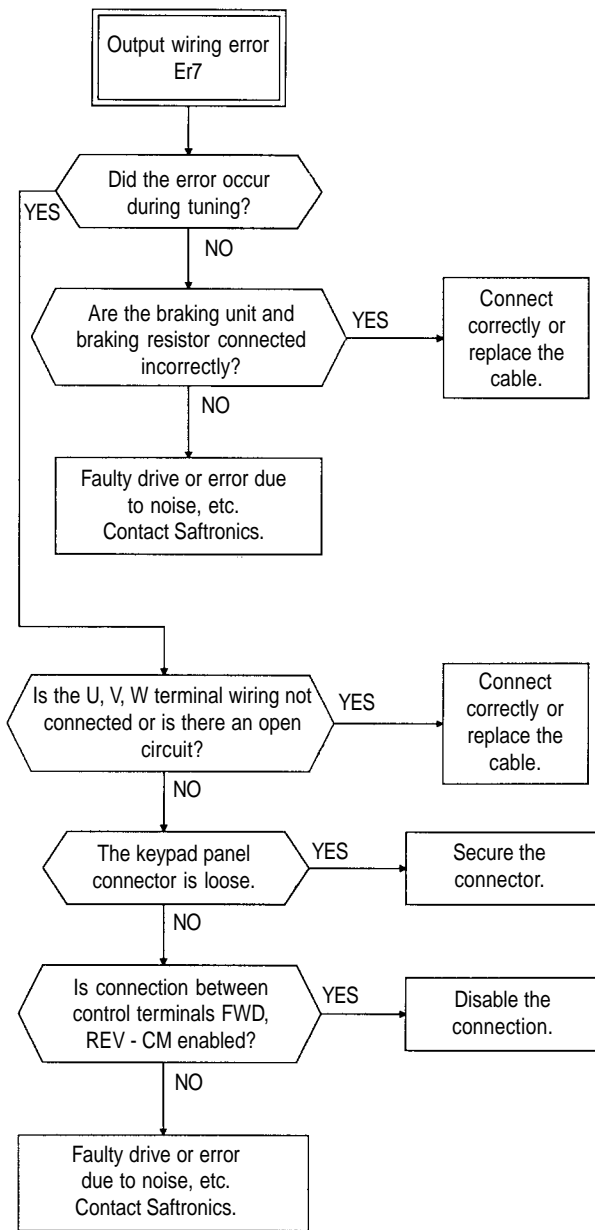

(9) Input PhaseLoss

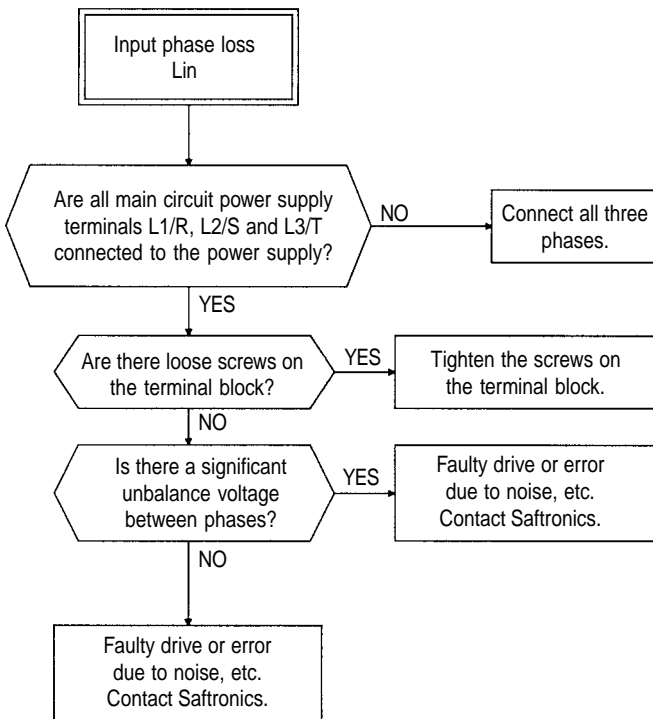

7.2 Abnormal motor rotation

(1) If motor does not rotate

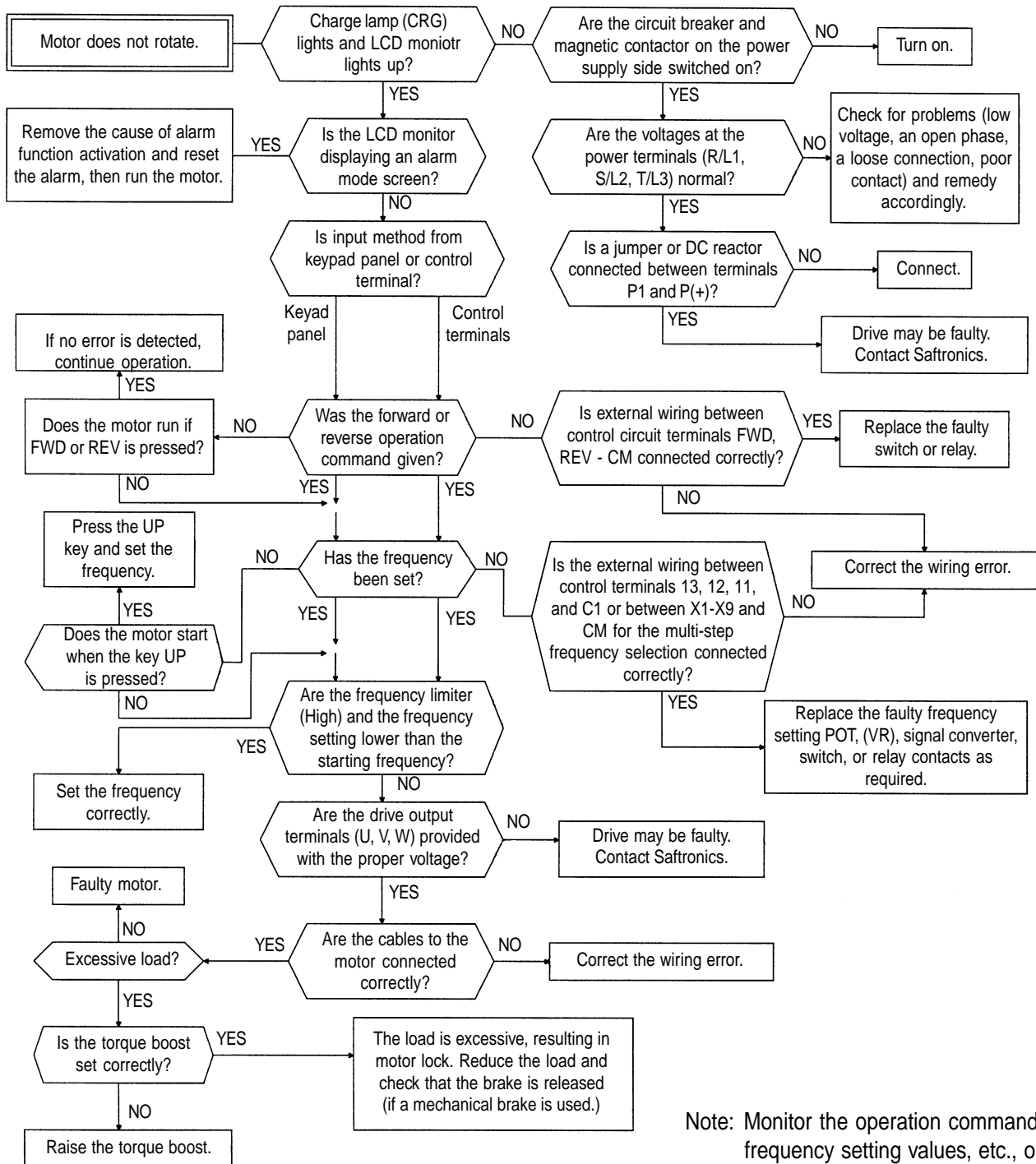

Note: Monitor the operation command or frequency setting values, etc., on the LED or LCD monitor after selecting the respective functions.

The motor does not rotate if the following commands are issued.

- An operation command is issued while the coast-to-stop or DC braking command is being input.

(2) If the motor rotates but the speed does not change

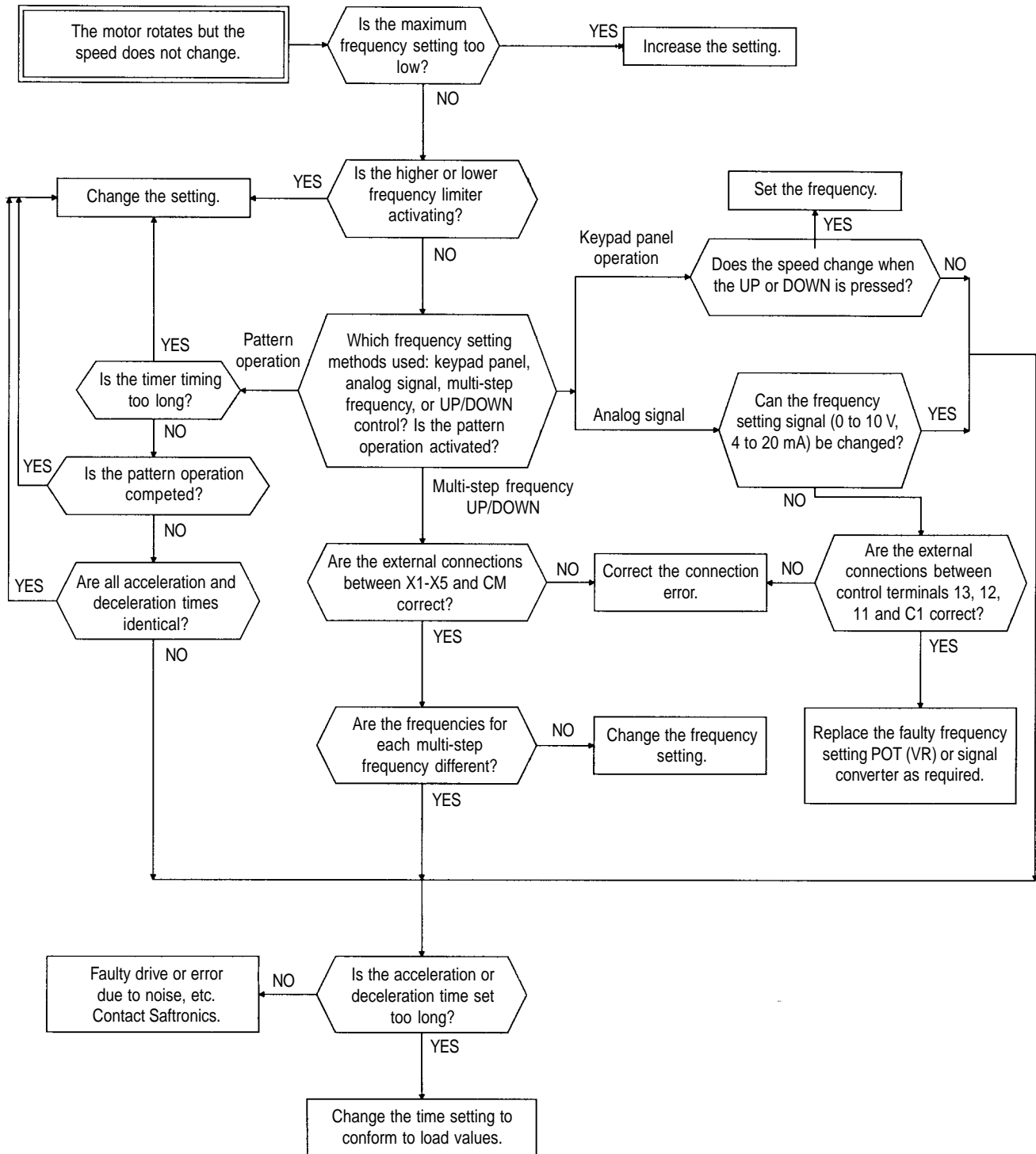

In the following cases, changing the motor speed is also restricted.

- Signals are input from control terminals both 12 and C1 when “F01 Frequency command 1” and “C30 Frequency command 2” are set to 3, and there is no significant change in the added value.
- The load is excessive, and the torque limiting and current limiting functions are activated.

(3) If the motor stalls during acceleration

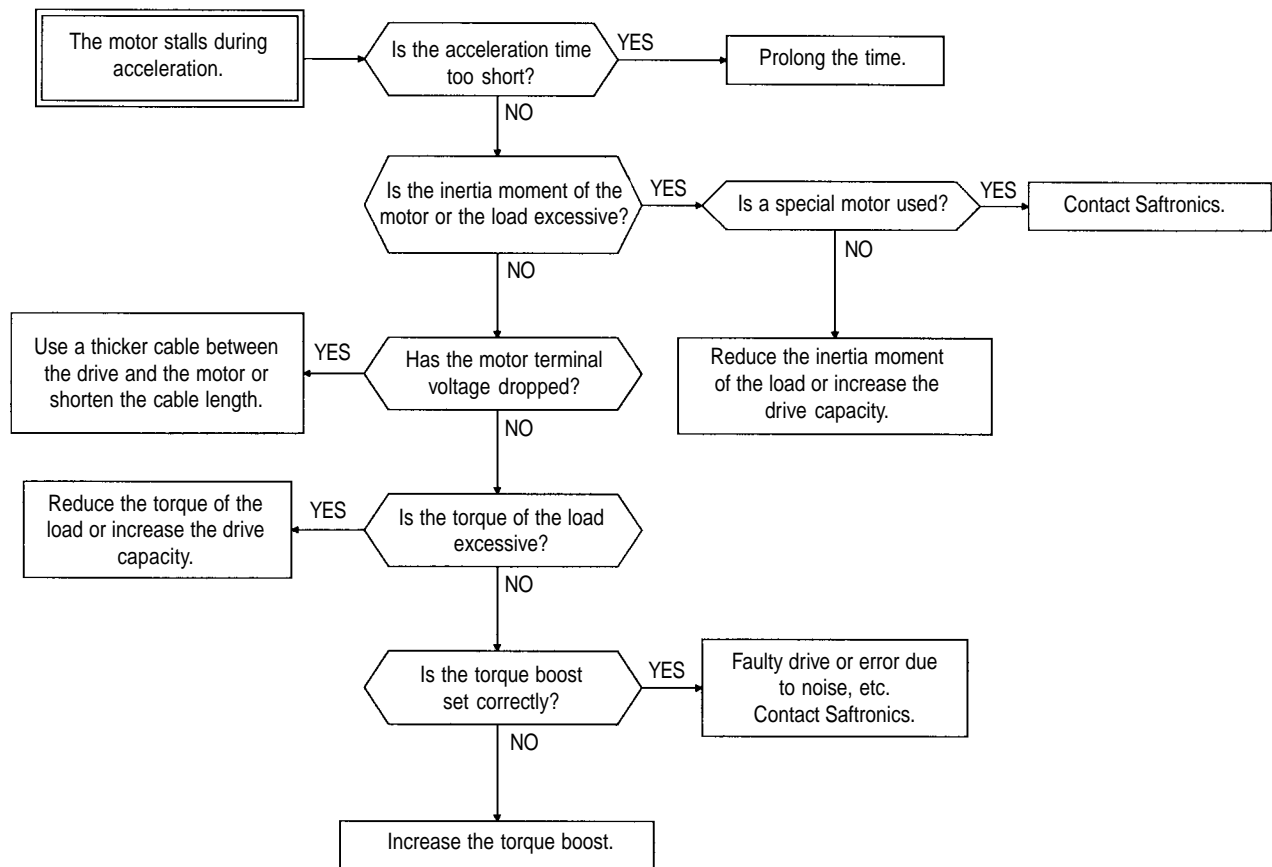

(4) Excessive heat generation from motor

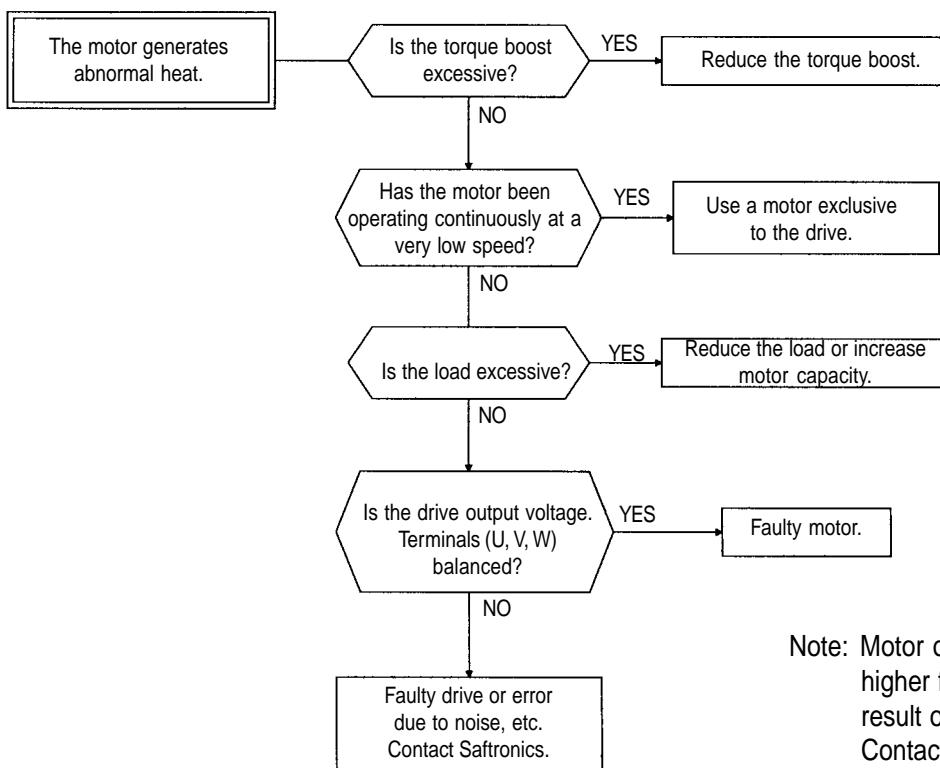

Note: Motor overheating following a higher frequency setting is likely the result of the current wave form. Contact Safronics.

8. Maintenance and Inspection

Perform daily and periodic inspection to avoid trouble and keep reliable operation for a long time. Take care of the following items during work.

8.1 Daily Inspection

Visually inspect errors in the state of operation from the outside without removing covers while the drive operates or while it is turned on.

1. Check if the expected performance (satisfying the standard specification) is obtained.
2. Check if the surrounding environment satisfies the standard specification.
3. Check that the display of the keypad panel is free from errors.
4. Check for abnormal noise, excessive vibration and bad smell.
5. Check for traces of overheat, discoloration and other defects.

8.2 Periodic Inspection

After stopping the operation, turn the power off and remove the front cover to perform periodic inspection.

The smoothing capacitor at the DC section of the main circuit takes time to be discharged after the power is turned off. After checking that the charge lamp (CRG) is unlit, check that the DC voltage is lower than the safety level (25 VDC) using a multimeter or the like before starting work.

DANGER

Turn the power off and wait for at least five minutes before starting inspection. (Further, check that the charge lamp is unlit and measure the DC voltage across the P (+) and N (-) terminals to check that it is lower than 25V.) **Otherwise electric shock could occur.**

Maintenance and inspection and parts replacement should be made only by appointed persons. Take off the watch, rings and other metallic matter before starting work. Use insulated tools.

Never remodel. **Otherwise electric shock or injuries could occur.**

Table 8-2-1 List of periodic inspection

Check part	Check item	How to inspect	Evaluation criteria
Environment	1) Check the ambient temperature, humidity, vibration and atmosphere (dust, gas, oil mist, water drops).	1) Check visually or measure using apparatus.	1) The standard specification must be satisfied.
	2) Check if tools or other foreign matter or dangerous objects are left around the equipment.	2) Visual inspection	2) No foreign or dangerous objects are left.
Voltage	Check if the voltages of the main circuit and control circuit are correct.	Measure using a multimeter or the like.	The standard specification must be satisfied.
Keypad panel	1) Check if the display is clear. 2) Check if there is missing parts in the characters.	1), 2) Visual inspection	1, 2) The display can be read and there is no fault.
Structure such as frame and cover	1) Abnormal noise and excessive vibration 2) Loose bolts (tightened parts) 3) Deformation and breakage 4) Discoloration and deformation caused by overheat 5) Stains and dust	1) Visual or hearing inspection 2) Retighten. 3), 4), 5) Visual inspection	1),2),3),4),5) No abnormalities

Main Circuit	Common	1) Check if bolts and screws are tight and not missing. 2) Check the devices and insulators for deformation, cracks, breakage and discoloration caused by overheat and deterioration. 3) Check for foulness and dust.	1) Retighten. 2), 3) Visual inspection	1), 2), 3) No abnormalities
	Conductor and wire	1) Check the conductor for discoloration and distortion caused by overheat. 2) Check the sheath of the cable for cracks and discoloration.	1), 2) Visual inspection	1), 2) No abnormalities
	Terminal block	Damage	Visual inspection	No abnormalities
	Smoothing capacitor	1) Check for electrolyte leakage, discoloration, cracks and swelling of the case. 2) Check for safety valve protrusion and remarkably protruding valve 3) Measure the capacitance.	1), 2) Visual inspection 3) Monitor H42 Life judgement and measure with capacitance probe.	1), 2) No abnormalities 3) Capacitance ΔU (Initial value) x 0.85
Main Circuit	Resistor	1) Check for odor caused by overheat and cracked insulator. 2) Check for broken wire.	1) Smelling and visual inspection 2) Visual inspection or measurement with multimeter under disconnection of one lead	1) No abnormalities 2) Within $\pm 10\%$ of displayed resistance
	Transformer	Check for abnormal roaring noise and odor.	Hearing, visual and smelling inspection	No abnormalities
	Relay	1) Check for chatters during operation. 2) Check for rough contacts.	1) Hearing inspection 2) Visual inspection	1),2) No abnormalities
Control circuit	Control printed circuit board, connector	1) Check for loose screws and connectors. 2) Check for odor and discoloration. 3) Check for cracks, breakage, deformation and remarkable rust. 4) Check the capacitors for electrolyte leaks and deformation.	1) Retighten. 2) Smelling and visual inspection 3), 4) Visual inspection	1),2),3),4) No abnormalities
Cooling system	Cooling fan	1) Check for abnormal noise and excessive vibration. 2) Check for loose bolts. 3) Check for discoloration caused by overheat.	1) Hearing and visual inspection, or turn manually (be sure to turn the power off) 2) Retighten. 3) Visual inspection 4) Life judgement based on maintenance data*	1) Smooth rotation 2),3) No abnormalities
	Ventilation path	Check the heat sink, intake and exhaust ports for clogging and foreign matter.	Visual inspection	No abnormalities

Remarks: Remove foulness using cleaning cloth which is chemically neutral. Use a vacuum cleaner to remove dust.

Judgement of life using maintenance data

The maintenance data of function codes H42 and H43 can be used to display data for the judgement of the capacitance of the capacitor in the main circuit and the life of the cooling fan to obtain a measure for the judgement of parts replacement. The capacitor life forecast signal is issued at the Y1 and Y2 terminals according to the measured capacitance after the capacitance of the capacity reaches 85%.

(1) Measurement of capacitance of capacitor in main circuit

This drive is provided with a function where the capacitance of the main circuit capacitor is automatically measured upon shutoff of the drive under certain conditions and it is displayed on the keypad panel upon power-up.

The capacitance of the capacitor is displayed in the reduction ratio (% display) of the initial value stored inside the drive before shipment.

Procedure of measurement of capacitor capacitance

1. Remove the optional card from the drive if it is mounted. Disconnect the braking unit or direct current bus to another drive from the P (+) and N (-) terminals of the main circuit if there is any. The power factor improving reactor (DC reactor) may not be disconnected.
2. Turn the digital inputs (FWD, REV, X1-X5) at the control terminals off. Disconnect the RS 485 communication terminal if it is connected.
3. Turn the main power supply on. Check that the cooling fan rotates. Check that the drive is stopped. (The "OH2 external alarm" caused by deactivated digital input terminals does not cause a problem.)
4. Turn the main power supply off.
5. After the charge lamp is unlit completely, turn the main power supply on again.
6. Monitor function code H42 to check the capacitor capacitance (%).

(2) Life of cooling fan

Function code H43 indicates the total operation time of the cooling fan. The time is integrated in units of an hour and fractions shorter than an hour are ignored.

The actual life of the fan is largely effected by the temperature. Take the time as a measure.

Table 8-2-2 Measure for judgement of life based on maintenance data

Part	Judgement level
Main Circuit capacitor	85% or lower of the initial value
Cooling fan	30,000 hours (5 Hp or less), 25,000 hours (7.5 Hp or more)*1

*1: Assumed life of cooling fan at ambient drive temperature of 40°C

8.3 Measurement of Electrical Amounts in Main Circuit

Because the voltage and current of the power supply (input) of the main circuit of the drive and the output (motor) include harmonic components, the indicated value varies according to the type of the meter. Use meters indicated in Table 8-3-1 when measuring with meters for commercial frequencies.

Marketed power factor meters measuring phase difference between the voltage and current cannot measure the power factor. To obtain the power factor, measure the power, voltage and current on each of the input and output sides and calculate in the following formula.

Three-phase input:

$$\text{Power factor} = \frac{\text{Electric power [W]}}{\sqrt{3} \times \text{Voltage [V]} \times \text{Current [A]}} \times 100 [\%]$$

Single-phase input:

$$\text{Power factor} = \frac{\text{Electric power [W]}}{\text{Voltage [V]} \times \text{Current [A]}} \times 100 [\%]$$

8.4 Insulation Test

Because an insulation test is made in the factory before shipment, avoid a Megger test. If a Megger test is unavoidable, follow the procedure below. Because a wrong test procedure will cause breakage of the drive, take sufficient care.

A withstand voltage test will cause breakage of the inverter similarly to the Megger test if the test procedure is wrong. When the withstand voltage test is necessary, contact your distributor or Safronics.

(1) Megger test of main circuit

1. Use a 500 VDC Megger and shut off the main power supply without fail during measurement.
2. If the test voltage leaks to the control circuit due to the wiring, disconnect all the control wiring.
3. Connect the main circuit terminals with a common cable as shown in Fig. 8-4-1.
4. The Megger test must be limited to across the common line of the main circuit and the ground terminal (⚡G).
5. 5M Ω or a larger value displayed at the Megger indicates a correct state. (The value is for a discrete drive.)

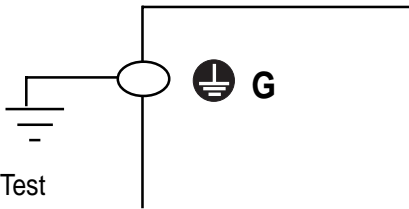

Fig. 8-4-1 Megger Test

(2) Do not perform a Megger test or withstand voltage test to the insulation test control circuit of the control circuit. Prepare a high resistance range tester for the control circuit.

1. Disconnect all the external wiring from the control circuit terminals.
2. Perform a continuity test to the ground. 1 M or a larger measurement indicates a correct state.

(3) External main circuit and sequence control circuit

Disconnect all the drive terminals so that the test voltage is not applied.

8.5 Replacement Parts

The life of the part is determined by the type of the part. The life of the part varies according to the environment and operating conditions, and replacement according to Table 8-5-1 is recommended.

Name of Part	Standard replacement years	Replacement method and others
Cooling fan	3 years	Replace with a new part
Smoothing capacitor	5 years	Replace with a new part (replace after inspection)
Electrolytic capacitors on printed circuit board	7 years	Replace with a new circuit board (replace after inspection)
Other parts	—	Determine after inspection

Table 8-5-1 Replacement parts

9. Warranty Parts and Service

The purpose of this section is to provide specific instructions to the user of the standard drive referenced in this book regarding warranty administration and how to obtain assistance on both in-warranty and out-of-warranty equipment.

For all warranty procedures, refer to section 10 of this instruction manual to identify the part or assembly.

If assistance is required to determine warranty status, identify defective parts, or obtain the name of your local distributor, call:

Saftronics, Inc

Technical Support

5580 Enterprise Parkway

Ft. Myers, FL 33905

Phone: 941-693-7200

Fax: 941-693-2431

Before calling the number above to determine warranty status, the drive serial number will be required. This is located on the drive nameplate. If the drive is still under warranty, further information will be required per the "In-Warranty Failure Checklist" shown on page 9-2 of this instruction manual. Please complete and return warranty registration card located inside back cover.

OUT-OF-WARRANTY PROCEDURES

When the defective part has been identified, contact your local authorized drives distributor to order replacement parts.

IN-WARRANTY FAILURE CHECKLIST

To assist with warranty troubleshooting, the following information is required. This data is needed to evaluate the cause in an effort to eliminate any further failures.

Model No.: _____

Serial No.: _____

Start-Up Date: _____

Failure Date: _____

Status When Failure Occurred (check one):

Power-Up _____ Running _____ Accel _____ Decel _____

Explanation of Failure _____

Application Information (check Yes or No)

Input Transformer: Yes _____ No _____

If Yes: KVA _____

L1 Volts _____ L2 Volts _____ L3 Volts _____

Power Factor Correction Capacitors: Yes _____ No _____

If Yes: Microfarrad _____

Other Equipment on Same Power Yes _____ No _____

If Yes, what?

Line Reactor on Input Yes _____ No _____

Input Starter Yes _____ No _____

Output Starter Yes _____ No _____

Motor Overloads Yes _____ No _____

Control Terminals Used (circle if used)

30A	30B	Y1	C1	FM	X1	X2	X3	X4	X5	PLC
30C	Y2	CME	11	12	13	CM	FWD	REV	CM	P24

Function Codes Different From Factory Settings

Function Code	Setting

Function Code	Setting

Failure Message (see Section 4)

Latest Fault _____ Previous Faults: No Message _____

Hz _____ 1. _____

A _____ 2. _____

V _____ 3. _____

After all of the Checklist information is acquired, contact the following number for technical Support: (941) 693-7200

When returning failed parts, reference the RMA# on the shipping documents that came with the replacement parts and ship failed parts to: Saftronics. Mark RMA# on shipping carton.

10. Replacement Parts

Catalog No.	Note	Drive HP & Quantity per drive								
		1/8	1/4	1/2	1	2	3	5	7.5	10

PC10 230VAC Three phase

Main Control Card

SE11-C2PCB		1	1	1	1	1	1	1		
SE11-C3PCB									1	1

CPU PCB

SE11-C1PCB		1	1	1	1	1	1	1		
------------	--	---	---	---	---	---	---	---	--	--

TRANSFORMER PCB

SE11-T1PCB		1	1	1	1	1	1	1		
------------	--	---	---	---	---	---	---	---	--	--

POWER PCB

SE11-PPCB-5.5-2									1	
SE11-PPCB-7.5-2										1

POWER MODULE

SE11PM0.1-2		1								
SE11PM0.2-2			1							
SE11PM0.4-2				1						
SE11PM0.8-2					1					
SE11PM1.5-2						1				
SE11PM2.2-2							1			
SE11PM3.7-2								1		
SPVC76-8-A	Converter								1	1
S6MBP75RS060	IGBT								1	
S6MBP100RS060	IGBT									1

KEYPAD

STP-E11S		1	1	1	1	1	1	1	1	1
----------	--	---	---	---	---	---	---	---	---	---

DC CAPACITOR UNIT

SE11-CU-5.5									1	
SE11-CU-7.5										1

FAN

SE11-FAN2.2						1	1			
SE11-FAN3.7								1		
SE11-FAN-7.5									1	1

Replacement Parts (cont.)

Catalog No.	Note	Drive HP & Quantity per drive					
		1/8	1/4	1/2	1	2	3

PC10 230VAC Single phase

Main Control Card

SE11-C2PCB		1	1	1	1	1	1
------------	--	---	---	---	---	---	---

CPU PCB

SE11-C1PCB		1	1	1	1	1	1
------------	--	---	---	---	---	---	---

TRANSFORMER PCB

SE11-T1PCB		1	1	1	1	1	1
------------	--	---	---	---	---	---	---

POWER MODULE

SE11PM0.1-7		1					
SE11PM0.2-7			1				
SE11PM0.4-7				1			
SE11PM0.8-7					1		
SE11PM1.5-7						1	
SE11PM2.2-7							1

KEYPAD

STP-E11S		1	1	1	1	1	1
----------	--	---	---	---	---	---	---

FAN

SE11-FAN3.7						1	1
-------------	--	--	--	--	--	---	---

Replacement Parts (cont.)

Catalog No.	Note	Drive HP & Quantity per drive						
		1/2	1	2	3	5	7.5	10

PC10 460VAC Three phase

Main Control Card

SE11-C3PCB							1	1
SE11-C4PCB		1	1	1	1	1		

CPU PCB

SE11-C1PCB		1	1			1		
SE11-C6PCB				1	1			

TRANSFORMER PCB

SE11-T2PCB-0.75		1	1	1	1	1		
SE11-T2PCB-2.2								

POWER PCB

SE11-PPCB-5.5-4							1	
SE11-PPCB-7.5-4								1

POWER MODULE

SE11PM0.4-4		1						
SE11PM0.8-4			1					
SE11PM1.5-4				1				
SE11PM2.2-4					1			
SE11PM3.7-4						1		
SPVC76-16-A	Converter						1	1
S6MBP50RS120	IGBT						1	1

KEYPAD

STP-E11S		1	1	1	1	1	1	1
----------	--	---	---	---	---	---	---	---

DC CAPACITOR UNIT

SE11-CU-5.5							1	
SE11-CU-7.5								1

FAN

SE11-FAN2.2				1	1			
SE11-FAN3.7						1		
SE11-FAN-7.5							1	1

11. Specifications

11.1 Standard Specifications

(1) Three-phase 230V input

Item		Detail specifications								
Drive Hp		1/8	1/4	1/2	1	2	3	5	7.5	10
Motor Hp		1/8	1/4	1/2	1	2	3	5	7.5	10
Output ratings	Rated capacity ¹ [kVA]	0.3	0.6	1.2	2.0	3.2	4.4	6.8	9.9	13.1
	Rated Voltage ² [V]	Three-phase 200V / 50 Hz, 200V, 220V, 230V / 60 Hz (with AVR ¹¹ function)								
	Rated current ³ [A]	0.7	1.4	2.5	4.0	7.0	10.0	16.5	23.5	31.0
		(0.8)	(1.5)	(3)	(5)	(8)	(11)	(17)	(25)	(33)
	Overload current rating	150% of rated output current for 1 min. 200% of rated output current for 0.5 s								
Rated frequency [Hz]	50, 60Hz									
Input ratings	Number of phases, voltage, frequency	Three-phase 200 to 230 V / 50 to 60 Hz ¹⁰								
	Voltage and frequency fluctuation	Voltage:	+10 to -15%, Voltage unbalance 2% or less ⁹							
		Frequency:	+5 to -5%							
	Resistance to instantaneous voltage drop ⁴	Operation continues at 165V or higher voltage. When the input voltage drops below 165V, operation continues for 15 ms.								
	Rated input current [A] (With DCR)	0.59	0.94	1.6	3.1	5.7	8.3	14	19.7	26.9
Rated input current [A] (Without DCR) ⁸	1.1	1.8	3.4	6.4	11.1	16.1	25.5	40.8	52.6	
Power requirement ⁵ [kVA]	0.3	0.4	0.6	1.1	2.0	2.9	4.9	6.9	9.4	
Braking	Braking torque ⁶ [%]	100		70			40		20	
	Braking torque ⁷ [%]	150								
	DC braking	Starting frequency: 0.2 to 60.0 Hz, braking current (0 to 100% in 1% increment), braking time (0.0 to 30.0 s)								
Enclosure (IEC60529)	IP20									
Cooling method	Self-cooling				Fan cooled					
Weight (lbs)	1.3	1.3	1.5	1.8	2.9	2.9	4.4	9.9	9.9	

*1 The rated capacity indicates a 230V input rating.

*2 Voltages greater than the source voltage cannot be output.

*3 Amperage values in parentheses () are applicable to operation with 3 kHz or lower carrier frequencies (F26 = 3 or less). These values also apply when the ambient temperature is below 40°C.

*4 Tests are performed under standard load conditions (load equivalent of 85% with an applicable standard motor) defined by JEMA.

*5 Data is with DC reactor (DCR) installed.

*6 Indicates the average braking torque for decelerating and stopping one motor from 60 Hz. (Varies according to the efficiency of the motor.)

*7 Indicates the value with an external braking resistor (option).

*8 Calculated on assumption that the drive is connected to 500 kVA power supply.

*9 Refer to IEC61800-3 5.2.3.

*10 Safe separation for control interface of this drive is provided when this drive is installed in overvoltage category II (CE Standard). Basic insulation for control interface of this drive is provided when this drive is installed in overvoltage category III (CE Standard).

*11 Automatic voltage regulator. (FO5)

(2) Single-phase 230V input

Item		Detail specifications					
Drive Hp		1/8	1/4	1/2	1	2	3
Motor Hp		1/8	1/4	1/2	1	2	3
Output ratings	Rated capacity ¹ [kVA]	0.3	0.6	1.2	2.0	3.2	4.4
	Rated Voltage ² [V]	Three-phase 200V / 50 Hz, 220V, 220V, 230V / 60 Hz (with AVR ¹⁰ function)					
	Rated current ³ [A]	0.7	1.4	2.5	4.0	7.0	10
		(0.8)	(1.5)	(3.0)	(5.0)	(8.0)	(11)
	Overload capability	150% of rated output current for 1 min. 200% of rated output current for 0.5 s					
Rated frequency [Hz]	50, 60Hz						
Input ratings	Phases, Voltage, Frequency	Single-phase 200 to 240 V / 50 to 60 Hz ⁹					
	Voltage/frequency fluctuation	Voltage: +10 to -15%, Voltage unbalance 2% or less Frequency: +5 to -5%					
	Momentary voltage dip capability ⁴	Operation continues at 165V or a higher voltage. When the input voltage drops below 165V, operation continues for 15 ms.					
	Rated current [A] (With DCR)	1.2	2.0	3.5	6.5	11.8	17.7
	Rated current [A] (Without DCR) ⁸	2.3	3.9	6.4	11.4	19.8	28.5
	Required power supply capacity ⁴ [kVA]	0.3	0.4	0.7	1.3	2.4	3.6
Braking	Braking torque ⁶ [%]	100		70		40	
	Braking torque ⁷ [%]	150					
	DC braking	Starting frequency: 0.2 to 60.0 Hz, braking current (0 to 100% in 1% increment), braking time (0.0 to 30.0 s)					
Enclosure(IEC60529)		IP20					
Cooling method		Natural cooling			Fan cooling		
Weight (lbs)		1.3	1.5	1.5	2.6	4	4.2

*1 The rated capacity indicates a 230V input voltage.

*2 Voltages greater than the source voltage cannot be output.

*3 Amperage values in parentheses () are applicable to operation with 3 kHz or lower carrier frequencies (F26 = 3 or less). These values also apply when the ambient temperature is below 40°C.

*4 Tests at standard load condition (85% load)

*5 Data is with DC reactor (DCR) installed.

*6 Indicates the average braking torque for decelerating and stopping one motor from 60 Hz. (Varies according to the efficiency of the motor.)

*7 Indicates the value with an external braking resistor (option).

*8 Calculated on assumption that the drive is connected to a 500kVA power supply.

*9 Safe separation for control interface of this drive is provided when this drive is installed in overvoltage category II (CE Standard). Basic insulation for control interface of this drive is provided when this drive is installed in overvoltage category III (CE Standard).

*10 Automatic voltage regulator (FO5).

(3) Three-phase 460V input

Item		Detail specifications						
Drive Hp		1/2	1	2	3	5	7.5	10
Motor Hp		1/2	1	2	3	5	7.5	10
Output ratings	Rated capacity ¹ [kVA]	1.2	2.0	2.9	4.4	7.2	10.3	14.3
	Rated Voltage ² [V]	Three-phase 380,400, 415V / 50 Hz; 380, 400, 440 / 60 Hz (with AVR ¹¹ function)						
	Rated current ³ [A]	1.4	2.1	3.7	5.3	8.7	12	16
		(1.5)	(2.5)	(3.7)	(5.5)	(9)	(13)	(18)
	Overload current rating	150% of rated output current for 1 min. 200% of rated output current for 0.5 s						
Rated frequency [Hz]	50, 60Hz							
Input ratings	Number of phases, voltage, frequency	Three-phase 380 to 480 V / 50 to 60 Hz ¹⁰						
	Voltage and frequency fluctuation	Voltage:		+10 to -15% Voltage unbalance 2% or less ⁹				
		Frequency:		+5 to -5%				
	Resistance to instantaneous voltage drop ⁴	Operation continues at 300V or a higher voltage. When the input voltage drops below 300V from the rated voltage, operation continues for 15 ms.						
	Rated input current [A] (With DCR)	0.82	1.5	2.9	4.2	7.1	10	13.5
		(Without DCR) ⁸	1.8	3.5	6.2	9.2	14.9	21.5
Power requirement ⁵ [kVA]	0.3	0.4	0.6	1.1	2.0	2.9	4.9	
Braking	Braking torque ⁶ [%]	70			40		20	
	Braking torque ⁷ [%]	150						
	DC braking	Starting frequency: 0.2 to 60.0 Hz, braking current (0 to 100% in 1% increment), braking time (0.0 to 30.0 s)						
Protective structure (IEC60529)	IP20							
Cooling method	Self-cooling			Fan cooled				
Weight (lbs)	2.4	2.6	2.9	3.1	4.2	9.9	9.9	

*1 The applicable standard motor refers to a 4 pole standard motor.

*2 The rated capacity indicates a 460V input voltage.

*3 Voltages greater than the source voltage cannot be output.

*4 Amperage values in parentheses () are applicable to operation with 3 kHz or lower carrier frequencies (F26 = 3 or less). These values also apply when the ambient temperature is below 40°C.

*5 Tests at standard load conditions (85% load)

*6 Indicates the value when using a DC reactor (DCR).

*7 Indicates the average braking torque for decelerating and stopping a discrete motor from 60 Hz. (Varies according to the efficiency of the motor.)

*8 Indicates the value with an external braking resistor (option).

*9 Calculated on assumption that the drive is connected to a 500kVA power supply.

*10 Refer to IEC61800-3 5.2.3.

*11 Safe separation for control interface of this inverter is provided when this inverter is installed in overvoltage category II (CE Standard). Basic insulation for control interface of this inverter is provided when this inverter is installed in overvoltage category III (CE Standard).

*12 Automatic voltage regulator (FO5).

9.2 Common Specifications

Item		Detail specifications	
Output frequency	Adjustment	Maximum frequency	50 to 400 Hz adjustable
		Base frequency	25 to 400 Hz adjustable
		Starting frequency	0.1 to 60.0 Hz adjustable, Holding time : 0.0 to 10.0s.
		Carrier frequency	0.75 to 15 kHz (The carrier frequency may automatically drop to 0.75 kHz to protect the drive.)
	Accuracy	Analog reference: Within $\pm 0.2\%$ ($25^{\circ} \pm 10^{\circ}\text{C}$) Digital reference: Within 0.01% (-10° to $+50^{\circ}\text{C}$)	
Reference resolution	Analog reference: 1/3000 of maximum output frequency Keypad panel reference: 0.01 Hz (99.99 Hz or lower), 0.1 Hz (100.0 to 400.0 Hz) LAN reference : 1/20000 of Maximum frequency (0.003Hz at 60Hz,0.006Hz at 120Hz,0.02Hz at 400Hz), or 0.01Hz (Fixed)		
Control	Voltage/freq. Characteristics	Adjustable at base and maximum frequency, with AVR control : 80 to 240 V(200V rating),160 to 480V(400V rating)	
	Torque boost	Automatic: Automatic torque boost can be selected with a function code setting. Manual: Setting by codes 1 to 31 (Boost for Variable torque available)	
	Starting torque	Starting torque 200% or above (with dynamic torque vector turned on, during 0.5 Hz operation)	
	DC braking	Braking time (0.0 to 30.0 s), braking current (0 to 100%), braking starting frequency (0.0 to 60.0 Hz) adjustable	
	Control method	Sinusoidal PWM (Dynamic torque vector control) with "current vibration suppression function" and "dead time compensation function"	
	Operation method	Keypad operation: starting and stopping with RUN and STOP keys. (Keypad panel) Digital input signal: forward (reverse) operation, stop command (3-wire operation possible), coast-to-stop command, external alarm, error reset, etc. Link operation: RS485 Modbus RTU (Standard) Profibus-DP,Interbus-S,DeviceNet,Modbus Plus, CAN open (Options)	

*1 Automatic voltage regulator (FO5).

Item	Detail Specifications
Frequency reference (UP/DOWN control) (Multistep frequency) (Link operation)	Keypad operation: UP key and DOWN key. Potentiometer (external potentiometer: 1 to 5 k ohm 1/2 W) 0 to ± 5 Vdc. 0 to ± 10 Vdc. 4 to 20 mAdc. 0 to +10 Vdc / 0 to 100% speed can be switched externally to +10 to 0 Vdc / 0 to 100% speed. 4 to 20 mAdc / 0 to 100% speed can be switched externally to 20 to 4 mAdc / 0 to 100% speed. An external signal can be used to control the UP or DOWN command. Up to 16 different frequencies can be selected by digital input signals. Link operation: RS485 (Standard) Profibus-DP, Interbus-S, DeviceNet, Modbus Plus, CAN open (Options)
Acceleration / deceleration time (Mode select)	Adjustable in 0.01 to 3600s range. (2 sets of time parameters can be set internally for each acceleration and deceleration.) Linear, S-curve (weak, strong), Non-linear available.
Frequency limiter	The high and low frequency limits can be set in Hz.
Bias frequency	Can be set in -400 to 400 Hz range.
Gain (frequency setting)	Can be set in a 0 to 200% range.
Jump frequency control	Three jump frequencies and jump width (0 to 30 Hz) can be set.
Rotating motor pickup (Flying start)	Operation without shock is possible.
Auto-restart after momentary power failure	The motor speed can be detected after power recovery so that the drive is started at that speed.
Slip compensation control	The load can be detected for the control of the output frequency. The compensation value can be set in a 0.00 to +15.00 Hz range of the rated frequency.
Droop operation	The load can be detected for the control of the frequency. The compensation value can be set in a -9.9 to 0.0 Hz range of the rated frequency. (Speed droop characteristics)
Torque limiter	When the load torque in the driving or braking mode exceeds the setting, the output frequency is adjusted to control the load torque to an almost constant level. The limiting torque can be set between 20 to 200% and the driving and braking torque values can be set independently. The second torque limits can also be set.

	Item	Detail specifications
Control	PID control This function can control flowrate, pressure, etc. with analog feedback signal. The reference and feedback values are displayed in %. Reference signal Keypad operation UP key and DOWN key. : 0.0 to 100% Voltage input (Terminal 12) : 0 to 10Vdc Current input (Terminal C1) : 4 to 20mAdc Multistep frequency setting : Setting freq./Max. freq.x100% RS485 : Setting freq./Max. freq.x100% Feedback signal Terminal 12 (0 to +10Vdc or +10 to 0Vdc) Terminal C1(4 to 20mAdc or 20 to 4mAdc)	
	Second motor's setting The V/f pattern of the second motor can be selected by means of an external signal. The motor constants of the second motor can be set by means of an external signal. The electronic thermal overload relay of the second motor can be internally set for selection by means of an external signal.	
	Energy saving operation Weak magnetic flux can be set for light loads which allows operation with an increased motor efficiency.	
Display	During operation/stop The keypad panel can be extended. (Optional 5m extension cable is available.) 7-segment LED display items <ul style="list-style-type: none"> • Set frequency • Output current • Output voltage • Output frequency • Motor r/min • Line speed • PID setting/feedback values (A soft filter is provided to attenuate the fluctuation in the displayed value.) A charge lamp indicates power supply is energized.	
	When setting When tripped The function code and data code are displayed. [The cause of trip is displayed.] <ul style="list-style-type: none"> • OC1 (overcurrent: during acceleration) • OC2 (overcurrent: during deceleration) • OC3 (overcurrent: during constant speed operation) • OU1 (overvoltage: during acceleration) • OU2 (overvoltage: during deceleration) • OU3 (overvoltage: during constant speed operation) • LU (undervoltage) • Lin (input phase loss) • dbH (external braking resistor overheated (thermal overload relay)) • OH1 (overheat: heat sink) • OH2 (overheat: external thermal overload relay) • OL1 (overload: motor 1) • OL2 (overload: motor 2) • OLU (overload: drive) • Er1 (memory error) • Er2 (keypad panel communication error) • Er3 (CPU error) • Er4 (option error) • Er5 (option error) • Er6 (operating error) • Er7 (output wiring error) (impedance imbalance) • Er8 (RS485 communication error) 	
	During operation, when tripped The last four records of trip history are stored and displayed.	

Overload protection	Drive electronic thermal overload relay								
Overvoltage protection	A high voltage in the DC link circuit (approx. 400 Vdc for 230V class, approx. 800Vdc for 460V class) is detected.								
Overcurrent protection	The drive is protected against an overcurrent on the output.								
Surge protection	The drive is protected against a surge voltage between the power cable of the main line and ground.								
Undervoltage protection	Voltage level (approx. 200 Vdc for 230V class, approx. 400Vdc for 460V class) in the DC link circuit is detected.								
Overheat protection	The drive is protected against failure and overload of the cooling fan.								
Short-circuit protection	The drive is protected against an overcurrent caused by a short-circuit on the output.								
Ground fault protection	The drive is protected against an overcurrent caused by ground fault in the output wiring. * Detection when starting								
Motor protection	Electronic thermal overload relays protect general purpose motors and forced air motors. The thermal time constant can be adjusted from 0.5 to 10.0 min. Second electronic thermal overload relay can be provided. (Switched with external signal)								
Braking resistor protection	Upon overheating of the braking resistor (external unit),the drive operation stops.								
Stall prevention (simple torque limit)	<ul style="list-style-type: none"> • When the output current exceeds the setting during acceleration, the speed change is stopped to avoid an overcurrent fault. • When the output current exceeds the setting during constant speed operation, the frequency is decreased to maintain constant torque. • When the DC voltage exceeds the limit during deceleration, the speed change is stopped to avoid an overvoltage fault. 								
Input phase loss protection	The drive is protected against input voltage phase loss.								
Output phase loss protection	An unbalance in the impedance of the output circuit is detected and outputs an alarm. (Error during tuning only)								
Auto reset	The number of retries and wait time can be set before an alarm stop.								
Installation location	<ul style="list-style-type: none"> • Indoors • Locations without corrosive gases, flammable gases or dust (degree of pollution: 2) • Locations without direct sunlight 								
Ambient temperature	-10 to +50 °C								
Relative humidity	5 to 95% RH (without condensation)								
Altitude	1000 m Max. (Atmospheric pressure 86 to 106 kPa)								
Vibration	<table border="0"> <tr> <td>3mm</td> <td>2 to 9 Hz</td> </tr> <tr> <td>9.8m/s²</td> <td>9 to 20 Hz</td> </tr> <tr> <td>2m/s²</td> <td>20 to 55 Hz</td> </tr> <tr> <td>1m/s²</td> <td>55 to 200 Hz</td> </tr> </table>	3mm	2 to 9 Hz	9.8m/s ²	9 to 20 Hz	2m/s ²	20 to 55 Hz	1m/s ²	55 to 200 Hz
3mm	2 to 9 Hz								
9.8m/s ²	9 to 20 Hz								
2m/s ²	20 to 55 Hz								
1m/s ²	55 to 200 Hz								
Storage temperature	-25 to +65 °C								
Storage humidity	5 to 95% RH (without condensation)								

9.3 External Dimensions

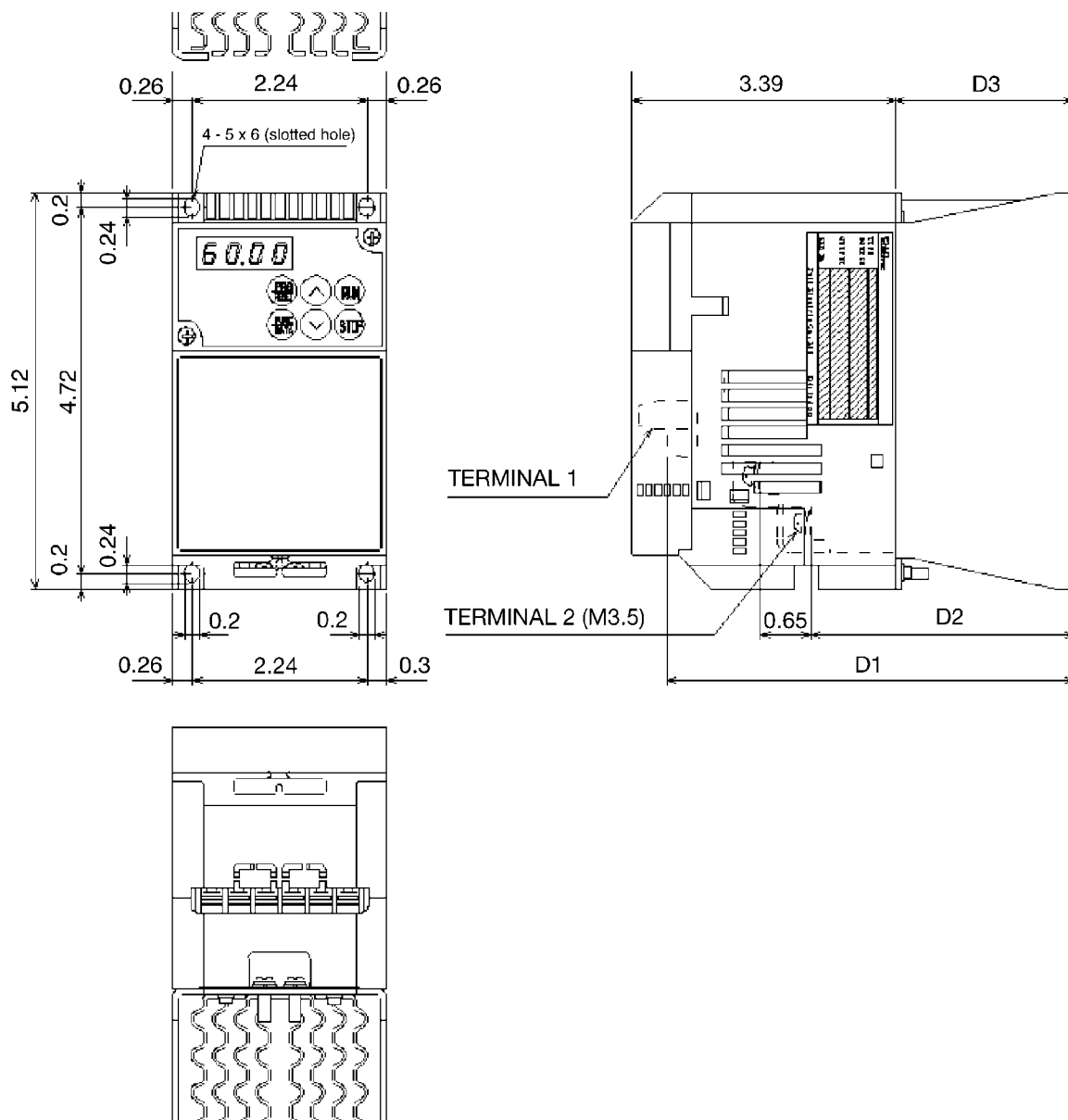

Model No.	Part No.	Nominal applicable motor [Hp]	External dimensions (inches)			
			D	D1	D2	D3
PC10E1ST32F12 **	PC102F12-9	1/8	3.78	3.35	1.5	0.39
PC10E1ST12F12 **	PC102F12-91					
PC10E1ST32F25 **	PC102F25-9	1/4	3.98	3.55	1.7	0.59
PC10E1ST12F25 **	PC102F25-91					
PC10E1ST32F50 **	PC102F50-9	1/2	4.65	4.22	2.37	1.26
PC10E1ST12F50 **	PC102F50-91					
PC10E1ST32001 **	PC102001-9	1	5.67	5.24	3.39	2.28

** Indicates factory use.

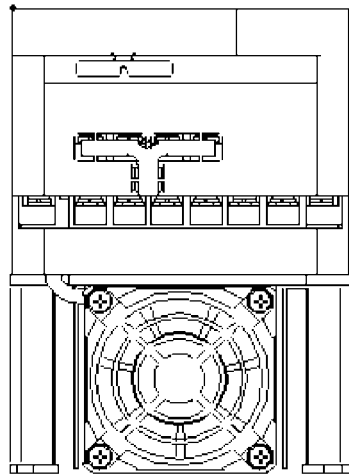
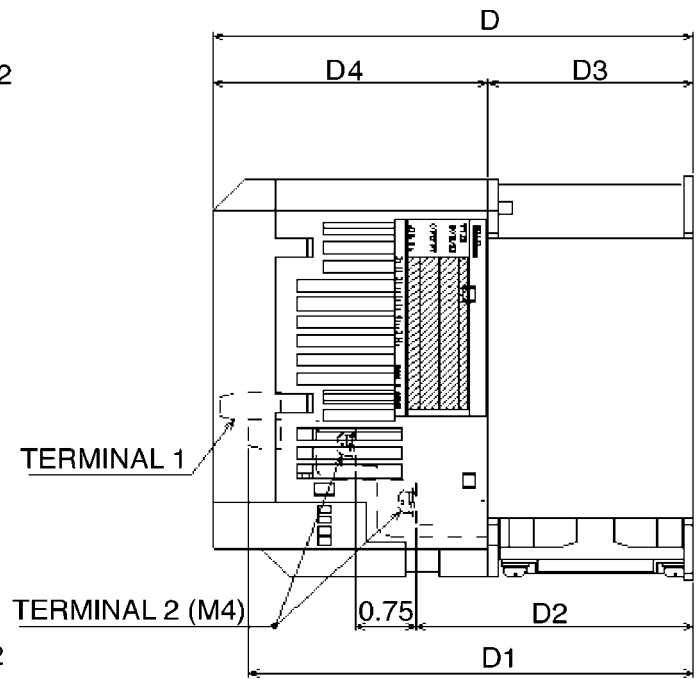
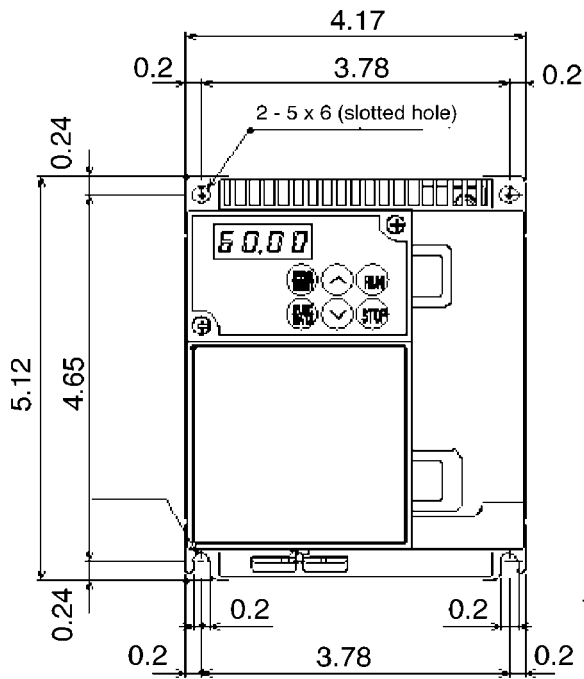

Model No.	Part No.	Nominal applicable motor [Hp]	External dimensions (inches)			
			D	D1	D2	D3
PC10E1ST32002 **	PC102002-9	2	5.91	5.46	3.41	2.52
PC10E1ST32003 **	PC102003-9	3	5.91	5.46	3.41	2.52
PC10E1ST12001 **	PC102001-91	1	4.96	4.51	2.46	1.57
PC10E1ST34F50 **	PC104F50-9	1/2	4.96	4.51	2.46	1.57
PC10E1ST34001 **	PC104001-91	1	5.91	5.46	3.41	2.52
PC10E1ST34002 **	PC104002-91	2	6.69	6.24	3.41	2.52
PC10E1ST34003 **	PC104003-91	3	6.69	6.24	3.41	2.52

**Indicates factory use

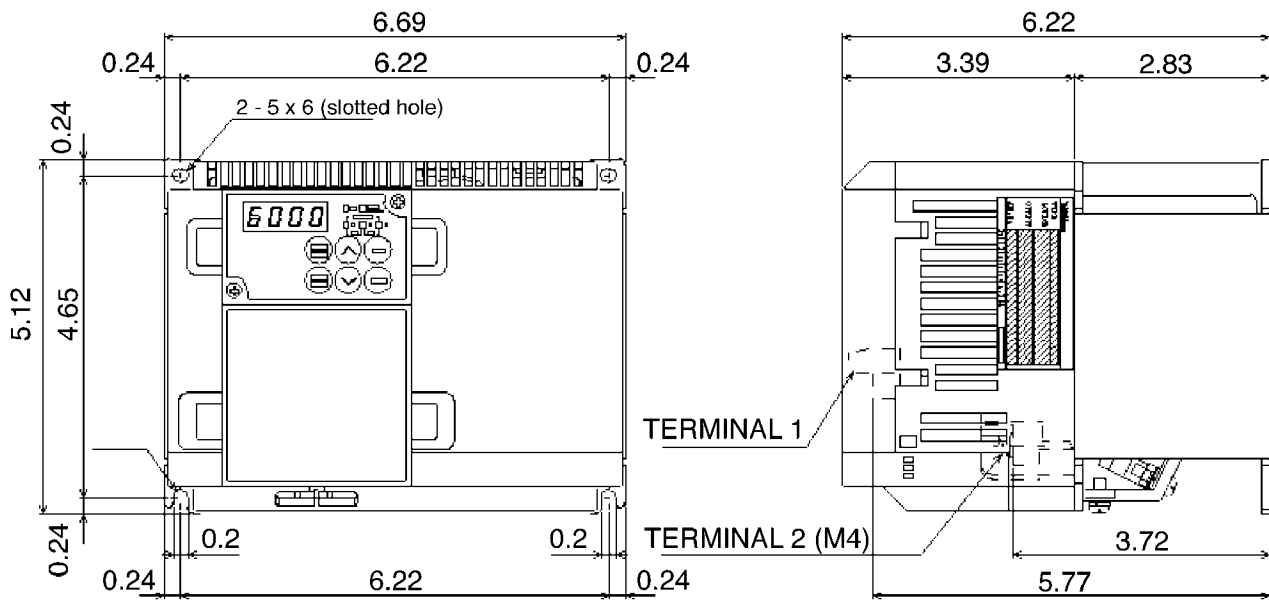

Model No.	Part No.	Nominal applicable motor [Hp]
PC10E1ST32005 **	PC102005-9	5
PC10E1ST12002 **	PC102001-91	2
PC10E1ST12003 **	PC102003-91	3
PC10E1ST34005 **	PC104005-9	5

** Indicates factory use.

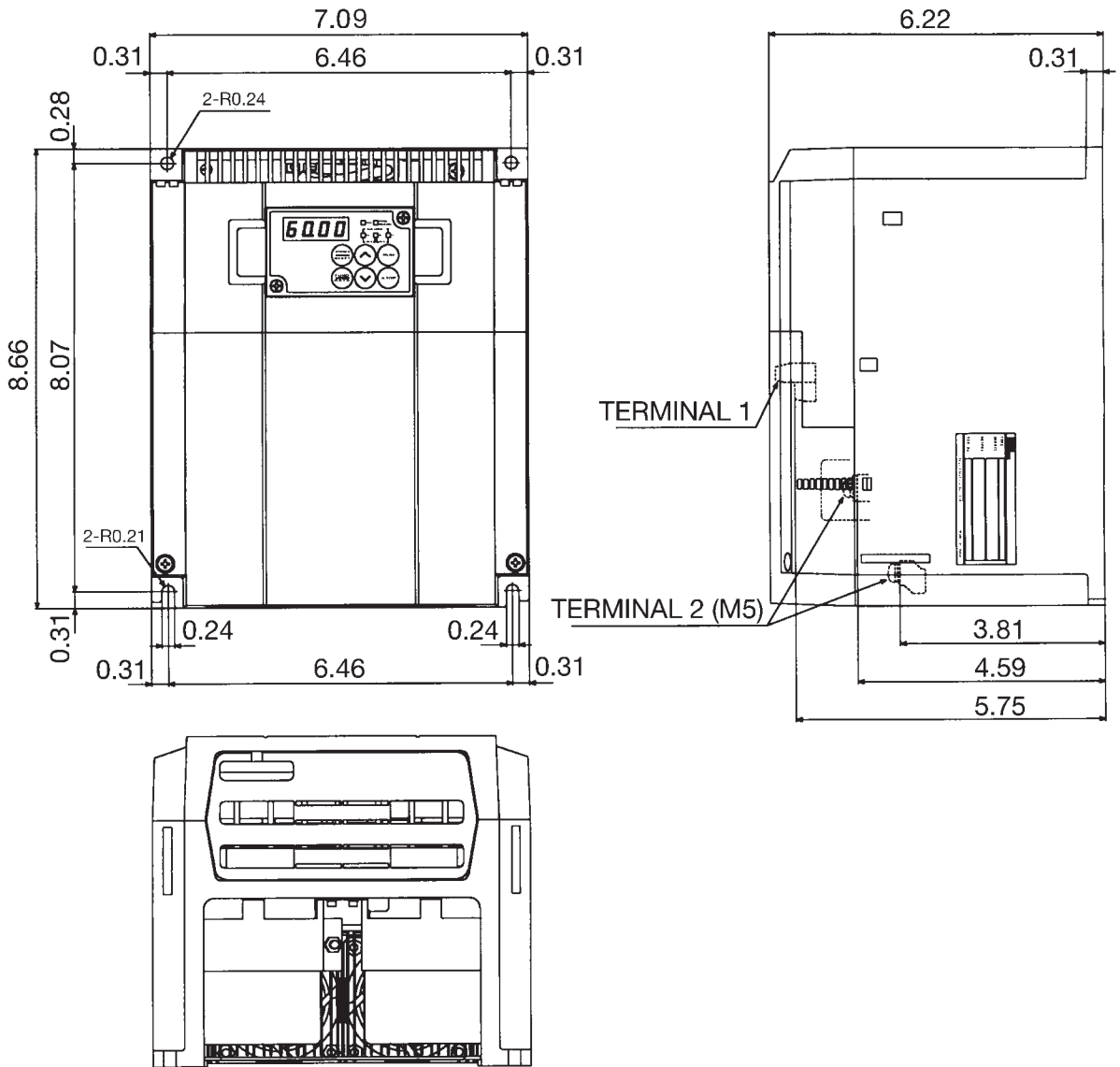

Model No.	Part No.	Nominal applicable motor [Hp]
PC10E1ST32007 **	PC102007-9	7.5
PC10E1ST32010 **	PC102010-9	10
VG10E1ST34007 **	PC104007-9	7.5
VG10E1ST34010 **	PC104010-9	10

** Indicates factory use

12 RS485 RTU Serial Communication

1. Outline

Modbus RTU protocol is a communication specification established to allow PLC to PLC communication or PLC to slave stations an inverter using a Modicon PLC.

- Broadcast and Query-Response type of messages are supported.
- A host computer (master) will transmit a query message to the inverter (E11). The inverter will transmit a response message back to the master that transmitted the query.
- The PC10 supports RTU – High Density Transmission . The PC10 does not support RTU – ASCII mode (a standard Modbus protocol transmission mode).
- CRC (Cyclic Redundancy Check) error check is performed in order to secure data transmission.

2. Communication specification

	Item	Specifications	Remarks
Communication (PC side)			
	Electrical specification	EIA RS485	Corresponds to RS232C with communication level converter
	Transmission distance	500m max.	
	Communication speed	2400, 4800, 9600, 19200bps	
	Synchronization method	Start - stop synchronization (UART)	
	Transmission mode	Half duplex	
	Communication configuration	Direct connection to inverters 1 : N (1≤N≤31)	
	Station address	0 : Broadcast 1-247 : Slave stations	Maximum number of stations is 31
	Transmission mode	Supports RTU mode (ASCII mode is not supported)	RTU has a high transmission density. ASCII has a one second timeout before an error occurs.
	Data length	8 bits	Fixed
	Parity/stop bit	No parity Stop bit 2 bits Even number parity Stop bit 1 bit Odd number parity	Stop bit is automatically set according to the selection of parity bit
	Error check method	CRC - 16 method (software)	Created polynomial : X16+X15+X2+1
	Transmission protocol	Based on Modicon's Modbus protocol	
	Wire breaking detection time	No response time (time-out) x (# of retries)	Timeout time is software settable.(H39)
	Retry times	Software setting for both physical layer error (parity, framing, overrun) and software error (processing status, check sum)	
Protocol			
	Function code	3 Reading of function	
		6 Writing to single function	
		8 Maintenance code	
		16 Writing to continuous function	
	Data length	2 bytes per register	
	Number of register (preset Multiple registers)	16 max.	

3. Connection

3.1 Connection method

Connect the wires between the control terminals (DX+, DX-) of the inverter and the host unit so as to surely become drawing in one stroke.

Note :

- 1) Keep all communication cable lengths to a minimum in order to reduce the effects of emi noise.
- 2) An RS485/RS232 converter must be used when attaching to a PLC/Computer that has an RS232C port.
- 3) Each Modbus RTU station, connected to the wire, must be assigned a unique station address.

Control terminals (only for communication)

Terminal marking	Terminal name	Function description
DX+	RS485 communication data (+)	Input/output terminals for RS485 communication. A maximum number of 31 stations can be connected to the multi-drop network.
DX -	RS485 communication data (-)	

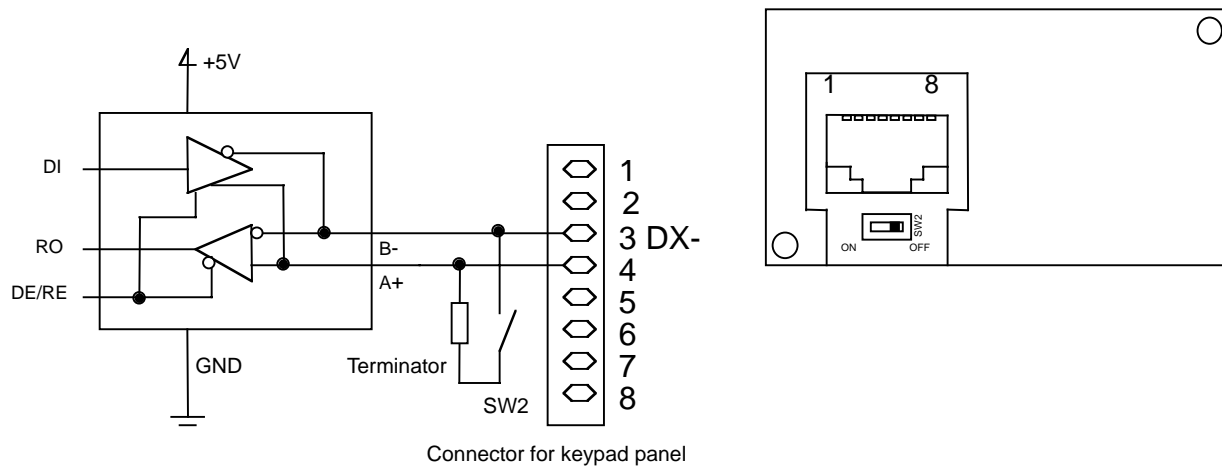

Equivalent circuit of RS485 interface

3.2 RS485 (Host unit interface)

RS485 interface is used when performing multi-drop bidirectional communication. The input/output terminals of the interface only allow a 2 wire connection.

Sort	Description	Example of terminals
2 - wire connection	Input and output (driver and receiver) are internally connected.	TRD+ Differential input terminal (hot side)
		TRD- Differential output terminal (common side)
		FG Frame ground

3.3 Connector and Communication Cable

Use marketed products for the connector, the communication cable and branch adapter. The following table shows the specification of each of them.

Item	Specification
Connector	RJ45 connector
Cable	Cable complying with EIA568 (for 10BASE-T Straight connection) (Max. wiring length: 500m)
Branch adapter	MS8-BA-JJJ (SK KOHKI CO., LTD. or equivalent.)

3.4 Example of connection

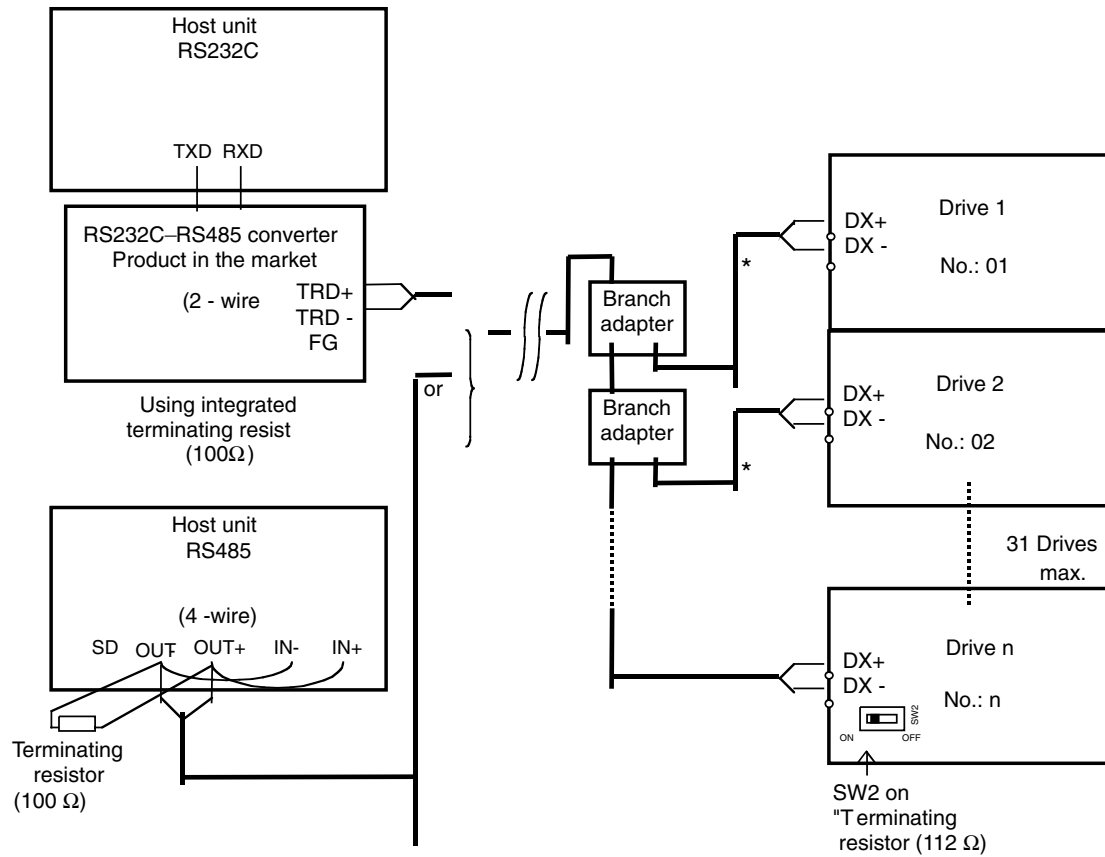

*: As short as possible (3 feet or less)

3.5 Communication level converter

An RS485/RS232 converter must be used when attaching to an RS232C serial interface port.

Use a converter that meets the following criteria.

® Specifications of recommended communication level converter

- Change over method of sending/receiving.....Automatic changeover by monitoring the sending data on host side (RS232C).
- Isolate Shall be isolated from RS485 side.
- Fail safe With fail safe function
- Others High noise immunity.

4. Message format

The normal formats to send RTU message are as follows.

1. Query processing
2. Broadcast processing

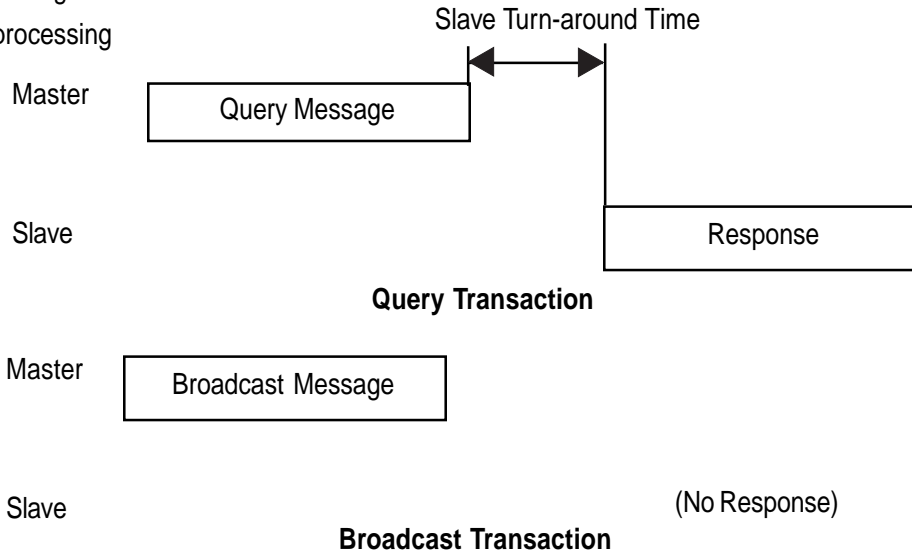

5. Message type

RTU protocol message types consist of the query, normal response, error response and broadcast.

- 1) Query

The master transmits a request to a single slave.

- 2) Normal Response

The slave will perform the requested processing and return a normal response RTU protocol message to the master in response to the query.

- 3) Error Response

The error response is returned to the master if the required function, from the master's query, can not be performed because of the reasons mentioned later. A message showing the reason why the request can not be performed is attached to the error message. Note: an error response is not returned when the error is caused by either a CRC error or physical transmission error.

- 4) Broadcast

The master sends the message to all slaves using address 0. All slaves will receive the broadcast message and perform the requested function. Because there will be no normal response messages, this process will terminate at the time-out time of the master. The master may then transmit the next outgoing message.

6. Message frame

The following are typical message frames. The details vary with the function code.

1 byte	1 byte	37 bytes max.	2 bytes
Station address	Function code	Information	Error check

6.1 Message field

Station address

0 is reserved for broadcast messages.

1–247 valid station addresses (1 byte in length).

Function Code (FC)

The Function Code is a single byte parameter. The following table with the shadowed background shows the function codes used by the PC10 drive.

FC: There are two function codes mentioned in this document. One is the Modbus RTU message function code which will be referred to as "FC". The second is the PC10 parameter function codes.

FC	Description
0_2	Not yet used
3	Reading of function
4_5	Not yet used
6	Writing to single function
7	Not yet used
8	Maintenance code
9_15	Not yet used
16	Writing to continuous function (max. 16data)
17_127	Not yet used
128_255	Reserved for exception response

Information

Refer to section "8. Sort of Messages" for detailed specification of the information field for each message type (broadcast, query, normal response and error response).

Error Check

The error check field is 2 bytes length data of CRC - 16 check system. As for details of CRC - 16 calculation or algorithm, refer to the following documents or "7. CRC - 16" (Fanuc Automation - Programmable Control Products - AC Users Manual)

Since the information field length is variable, the frame length necessary to calculate CRC - 16 code from FC and byte count data. As for byte count, refer to "Sort of Message".

Error Check

The error check field is a 2 byte CRC-16 checksum. For details of CRC-16 calculation or algorithm, refer to section "CRC - 16" or the Fanuc Automation - Programmable Control Products - Users Manual.

Since the information field length is variable, the frame length necessary to calculate CRC-16 code from FC and byte count data. For byte count, refer to section "8. Sort of Messages"

6.2 Character format

Each byte of a message is called a character. The character formats are shown below.

A character is configured with a start bit (logic 0), 8-data bits, addition of parity bit (selection) and stop bit (logic1).

Without parity

LSB								MSB		
0	1	2	3	4	5	6	7	8	9	10
Start	Data							Stop		

With Parity

LSB								MSB		
0	1	2	3	4	5	6	7	8	9	10
Start	Data							Parity (optional)	Stop	

7. CRC - 16

CRC (Cyclic Redundancy Check) is one of the most effective checksum algorithms used today to verify message data integrity. The transmitting station calculates a CRC and adds the CRC (2 bytes in length) to the last frame. The receiving station also calculates a CRC for the received data and compares the calculated to the received CRC. If the two CRC's agree, then the message is accepted.

The short description of calculating a CRC is as follows.

- The data is converted to polynomial form (for example, 1100 0000 0010 0001 $\Rightarrow X^{15}+X^{14}+X^5+1$) is divided by a created polynomial (17bit $X^{16}+X^{15}+X^2+1$). CRC is the remainder (16 bits) of this division.
- The quotient is neglected. The remainder is sent as the CRC-16.
- The receiving side divides this message (added CRC) by the created polynomial, and considers the transmission complete and correct when the remainder is 0.

The created polynomial represents the data algebraically with exponent of X such as X^3+X^2+X , instead of description such as a binary code 1101. The created polynomial is allowed any length and any bit patterns, but several standard created polynomials are defined to optimize the error detection. In RTU protocol, the created polynomial ($X^{16}+X^{15}+X^2+1$) that is binary 1 1000 0000 0000 0101 is used. In this case the created CRC is known as CRC-16.

7.1 CRC algorithm

- CRC data: This is a single word memory location. Updated during the calculation process and included in the transmission frame as a message checksum.
- The CRC is calculated after the entire message has been loaded into the transmit/sending buffer. The CRC may be calculated as each word of the message is loaded into the transmit/sending buffer to reduce processor overhead and timing.
- The receiving process is the same algorithm as above. But a code used to compare the CRC of sent data and the CRC calculated on receiving side is added.

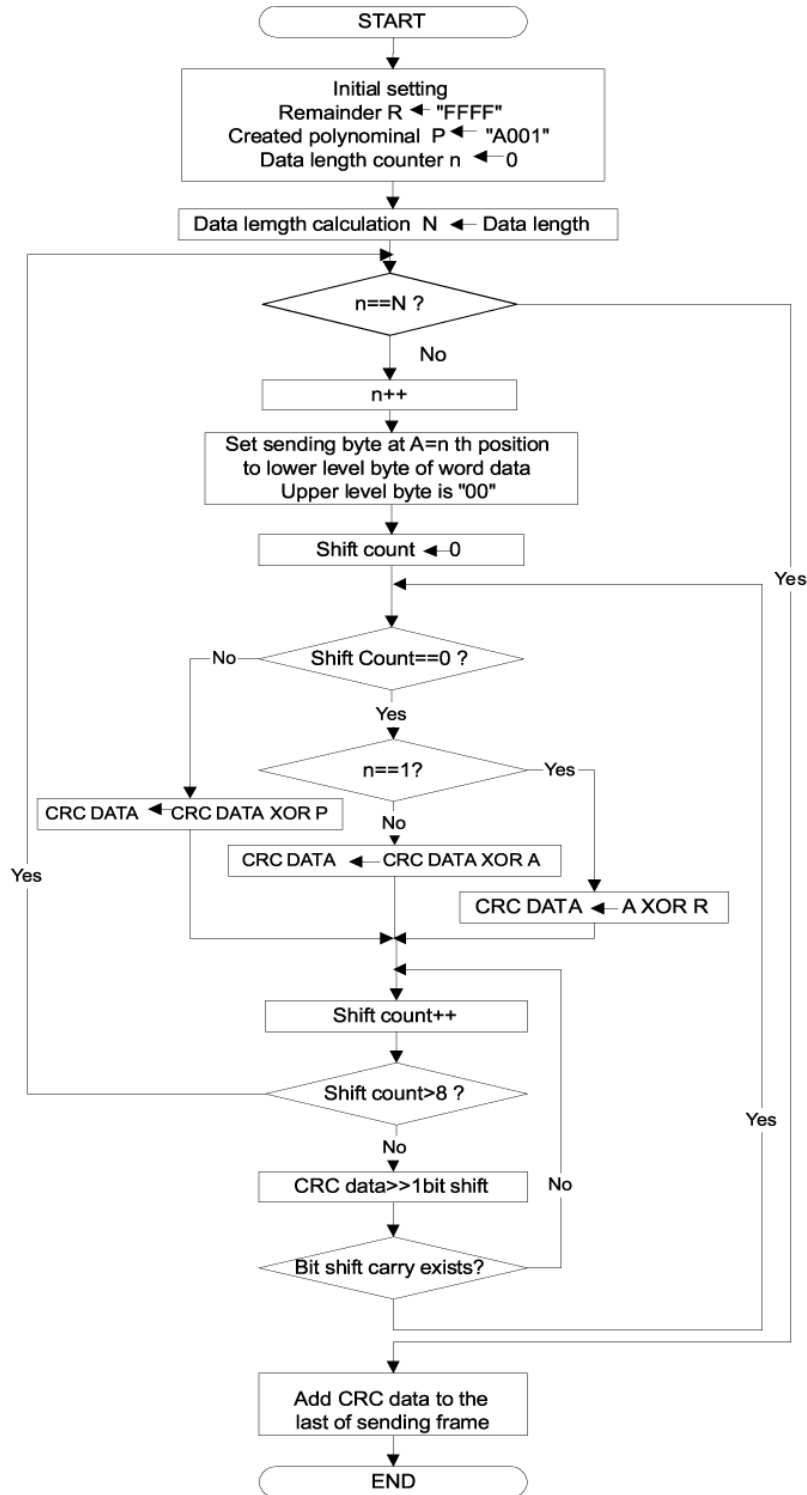

7.2 Calculation example of CRC - 16

Here is an example of a function code = Reading message.

Station address=1_C FC=3_C function code=P49 (0331H = 0817 decimal)_C number of variables to read=20 (Note: max.16 for E11)_C G.P is created polynomial (1010 0000 0000 0001 = A001h)

Note: A variable is a word data type (2 bytes).

Station address	FC	Function code								Number of variables to read								
		03H				31H				00H				14H				
N	Process	15	14	13	12	11	10	9	8	7	6	5	4	3	2	1	0	Flag
1	Initial data R="FFFF"	1	1	1	1	1	1	1	1	1	1	1	1	1	1	1	1	
2	1st data byte	0	0	0	0	0	0	0	0	0	0	0	0	0	0	0	1	
3	CRC=No.1 Xor No.2	1	1	1	1	1	1	1	1	1	1	1	1	1	1	1	0	
4	Shift>>2 (up to Flag=1)	0	0	1	1	1	1	1	1	1	1	1	1	1	1	1	1	1
5	CRC=No.4 Xor G.P	1	0	0	1	1	1	1	1	1	1	1	1	1	1	1	0	
6	Shift>>2	0	0	1	0	0	1	1	1	1	1	1	1	1	1	1	1	1
7	CRC= o.6 Xor G.P	1	0	0	0	0	1	1	1	1	1	1	1	1	1	1	0	
8	Shift>>2	0	0	1	0	0	0	0	1	1	1	1	1	1	1	1	1	1
9	CRC=No.8 Xor G.P	1	0	0	0	0	0	0	1	1	1	1	1	1	1	1	0	
10	Shift>>2 (8shift finish)	0	0	1	0	0	0	0	0	0	1	1	1	1	1	1	1	1
11	CRC=No.10 Xor G.P	1	0	0	0	0	0	0	0	0	1	1	1	1	1	1	0	
12	2nd data byte	0	0	0	0	0	0	0	0	0	0	0	0	0	0	1	1	
13	CRC=No.11 Xor No.12	1	0	0	0	0	0	0	0	0	1	1	1	1	1	0	1	
14	Shift>>1	0	1	0	0	0	0	0	0	0	0	1	1	1	1	1	0	1
15	CRC=No.14 Xor G.P	1	1	1	0	0	0	0	0	0	0	1	1	1	1	1	1	
16	Shift>>1	0	0	1	1	0	0	0	0	0	0	0	1	1	1	1	1	1
17	CRC=No.16 Xor G.P	1	1	0	1	0	0	0	0	0	0	0	1	1	1	1	0	
18	Shift>>2	0	0	1	1	0	1	0	0	0	0	0	0	0	1	1	1	1
19	CRC=No.18 Xor G.P	1	0	0	1	0	1	0	0	0	0	0	0	0	1	1	0	
20	Shift>>2	0	0	1	0	0	1	0	1	0	0	0	0	0	0	0	1	1
21	CRC=No.20 Xor G.P	1	0	0	0	0	1	0	1	0	0	0	0	0	0	0	0	
22	Shift>>2 (8shift finish)	0	0	1	0	0	0	0	1	0	1	0	0	0	0	0	0	0
23	3rd data byte	0	0	0	0	0	0	0	0	0	0	0	0	0	0	1	1	
24	CRC=No.22 Xor No.23	0	0	1	0	0	0	0	1	0	1	0	0	0	0	1	1	
25	Shift>>	0	0	0	1	0	0	0	0	1	0	1	0	0	0	0	1	1
26	CRC=No.25 Xor G.P	1	0	1	1	0	0	0	0	1	0	1	0	0	0	0	0	
27	Shift>>6	0	0	0	0	0	0	1	0	1	1	0	0	0	0	1	0	1
28	CRC=No.27 Xor G.P	1	0	1	0	0	0	1	0	1	1	0	0	0	0	1	1	
29	Shift>>1	0	1	0	1	0	0	0	1	0	1	1	0	0	0	0	1	1
30	CRC=No.29 Xor G.P	1	1	1	1	0	0	0	1	0	1	1	0	0	0	0	0	
31	4th data byte	0	0	0	0	0	0	0	0	0	0	1	1	0	0	0	1	
32	CRC=No.30 Xor No.31	1	1	1	1	0	0	0	1	0	1	0	1	0	0	0	1	
33	Shift>>1	0	1	1	1	1	0	0	0	1	0	1	0	1	0	0	0	1
34	CRC=No.33 Xor G.P	1	1	0	1	1	0	0	0	1	0	1	0	1	0	0	1	
35	Shift>>1	0	1	1	0	1	1	0	0	0	1	0	1	0	1	0	0	1
36	CRC=No.35 Xor G.P	1	1	0	0	1	1	0	0	0	1	0	1	0	1	0	1	
37	Shift>>1	0	1	1	0	0	1	1	0	0	0	1	0	1	0	1	0	1
38	CRC=No.37 Xor G.P	1	1	0	0	0	1	1	0	0	0	1	0	1	0	1	1	
39	Shift>>1	0	1	1	0	0	0	1	1	0	0	0	1	0	1	0	1	1
40	CRC=No.37 Xor G.P	1	1	0	0	0	0	1	1	0	0	0	1	0	1	0	0	
41	Shift>>3	0	0	0	1	1	0	0	0	0	1	1	0	0	0	1	0	1
42	CRC=No.41 Xor G.P	1	0	1	1	1	0	0	0	0	1	1	0	0	0	1	1	
43	Shift>>1	0	1	0	1	1	1	0	0	0	0	1	1	0	0	0	1	1
44	CRC=No.43 Xor G.P	1	1	1	1	1	1	0	0	0	0	1	1	0	0	0	0	
45	5th data byte	0	0	0	0	0	0	0	0	0	0	0	0	0	0	0	0	
46	CRC=No.44 Xor No.45	1	1	1	1	1	1	0	0	0	0	1	1	0	0	0	0	
47	Shift>>5	0	0	0	0	0	1	1	1	1	1	1	0	0	0	0	1	1
48	CRC=No.47 Xor G.P	1	0	1	0	0	1	1	1	1	1	1	0	0	0	0	0	
49	Shift>>3	0	0	0	1	0	1	0	0	1	1	1	1	1	1	0	0	0
50	6th data byte	0	0	0	0	0	0	0	0	0	0	0	1	0	1	0	0	
51	CRC=No.49 Xor No.50	0	0	0	1	0	1	0	0	1	1	1	0	1	0	0	0	
52	Shift>>4	0	0	0	0	0	0	0	1	0	1	0	0	1	1	1	0	1
53	CRC=No.52 Xor G.P	1	0	1	0	0	0	0	1	0	1	0	0	1	1	1	1	
54	Shift>>1	0	1	0	1	0	0	0	0	1	0	1	0	0	1	1	1	1
55	CRC=No.54 Xor G.P	1	1	1	1	0	0	0	0	1	0	1	0	0	1	1	0	
56	Shift>>2	0	0	1	1	1	1	0	0	0	0	1	0	1	0	0	1	1
57	CRC=No.56 Xor G.P	1	0	0	1	1	1	0	0	0	0	1	0	1	0	0	0	
58	Shift>>1	0	1	0	0	1	1	1	0	0	0	0	1	0	1	0	0	0
Transmission CRC		4				E				1				4				

The complete message to be sent by the Master to the drive is given below. (The inverter should respond to this query with the appropriate error response message)

Station address	FC	Function code		Number of variables to read		CRC check	
01H	03H	03H	31H	00H	14H	14H	4EH

NOTE: In this example, a length of 20 bytes of read data was requested. The E11 has a maximum limitation of 16 bytes of read data.

7.3 Calculation of frame length

It is necessary to determine the length of a variable length message in order to calculate the CRC-16 for the message. The length of any message type can be calculated using the table below.

FC	Description	Message length of query and broadcast (except CRC code)	Response message length (except CRC code)
3	Reading of function	6 bytes	3+(3rd) byte
6	Writing to single function	6 bytes	6 bytes
8	Maintenance code	6 bytes	6 bytes
16	Writing to continuous function	7+(7th) byte	6 bytes
128_255	Exception Function	Not yet used	3byte

* 7th, 3rd: Shows the data field length stored bytes-count which is at 7th and 3rd characters in the frame

8. Sort of messages

This section defines the RTU message formats and the field information. For the error responses, refer to "9. Transmission error"Ah

8.1 Reading of functions

8.2 Reading of data

Query

1 byte	1 byte	2 bytes	2 bytes	2 bytes
Station address	03H	Function code	Number of variables to read	Error check
		Hi Lo Hi	Lo	

Normal Response

1 byte	1 byte	1	2-32 bytes	2bytes
Station address	03H	Byte count	Variables Read data	Error check
		Hi, Lo (data 0), Hi, Lo (data 1), Hi, Lo (data 2)...		

Query

- Broadcast of address 0 can not be used (No response if it is used).
- The PC10 inverter will not respond to a broadcasted ("Station address"=0) Read (FC=03) query.
- FC=3 (03H)
- The inverter's parameter function code is 2 bytes in length. The high byte corresponds to the sort of functions (F, E, C, P, H, A, O, S, M). The low byte corresponds to the function numbers (0-99). Consequently, the setting data range of function sort is 0-8, 250-252 (F-M, u-t) and the function numbers are 0-99. However, the function numbers shall be set to the number subtracted 1 from the address.

For example, address 001FH shows F30 and the communication function code becomes 001EH.

Code	Sort	Name	Code	Sort	Name
0	F	Basic function	6	o	Option function
1	E	Terminal function	7	S	Command/function data
2	C	Control function	8	M	Monitor data
3	P	Motor 1 function	250		
4	H	High level function	251		
5	A	Motor 2 function	252		

- "Number of variables to read" is a 2 byte length(word). The range is 1-16 (01h-10h).
The "Function code" + "Number of variables to read" shall not exceed the upper limit of that particular function code. (example: up to 42 for F). If the data exceeds this range a transmission error will occur (Refer to "9. Transmission error").
- If you request a read from a function code that is "not yet used", the inverter will return a zero for data. No error will be generated.

Response

- The "byte count" range is 2-32. The "bytes count" (in the response) is equal to double the "number of variables read" (in the query) value (1-16).
- The variables being read are loaded high byte first.
- The requested function code address (in the query) is read and loaded first into the message, then the proceeding addresses contents follows. (When reading plural functions, if function code not yet used is included in and after the second functions, the reading data become unsettled).

8.3 Writing to single function

Query

1 byte	1 byte	2 bytes	2 bytes	2 bytes
Station address	06H	Function code	Write data	Error check
			Hi Lo	

Normal Response

1 byte	1 byte	2 bytes	2 bytes	2 bytes
Station address	06H	Function code	Write data	Error check

Query

- This message may be broadcasted (transmitting to address 0). A broadcast message will result in all slave stations executing the command but not returning a response.
- FC=6 (06H)
- The "Function code" is 2 bytes in length. See section "8.1 Reading of functions " for the "Function code" definitions.
- The "Write data" is 2 bytes in length. The write data is the data that will be written to the specified function address in the "Function code".

Response

- The "Normal response" message is the same as the query message.

8.4 Writing to continuous function

Query

1 byte	1 byte	2 bytes	2 bytes	1 byte	2_32 bytes	2 bytes
Station address	10H	Function code	No. of write data	Byte count	Write data	Error check
		Hi Lo Hi	Lo		Hi, Lo (data 0), Hi, Lo (data 1), Hi, Lo (data 2)	

Normal Response

1 byte	1 byte	2 bytes	2 bytes	2 bytes
Station address	10H	Function code	No. of write data	Error check

Query

- This message may be broadcasted (transmitting to address 0). A broadcast message will result in all slave stations executing the command but not returning a response.
- FC=16 (10H)
- The "Function code" is 2 bytes in length. See section "8.1 Reading of functions" for the "Function code" definitions.
- The "Number of write data" is 2 bytes in length and is the number of inverter variables to be written. The "Write data" range is 1-16.
The "Function code" + "Number of write data" shall not exceed the upper limit of that particular function code. (example: up to 42 for F). If the data exceeds this range a transmission error will occur (Refer to "9. Transmission error").
- The "Byte count" is 1 byte in length. The "Byte count" range is 2-32. The "Byte count" should be double the "Write data" value.
- The write data is the data that will be written starting at the specified function address in the "Function code". The "Write data" is word wide data with the high byte (Most Significant Byte) first. The first word of data corresponds with the address given in the "Function code".
- If a function code that is not yet used is included in the continuous write, that function code (address) is neglected and no error is generated.

Response

- The "Function code" and "Number of write data" is the same as that in the query.

8.5 Maintenance code

Query

1 byte	1 byte	2 bytes	2 bytes	2 bytes
Station address	08H	Diagnostic code 0000H	Data	Error check
	Hi Lo Hi	Lo		

Normal Response

1 byte	1 byte	2 bytes	2 bytes	2 bytes
Station address	08H	Diagnostic code 0000H	Data	Error check

Query

- The PC10 inverter will not respond to a broadcasted ("Station address"=0) "Maintenance code" (FC=08h) query.
- FC=8 (08H)
- The "Diagnostic code" is 2 bytes (1 word) in length and fixed to 0000H.
- The "Data" field is 2 bytes (1 word) in length.

Response

- The normal response message is the same as the query message.

9. Transmission error

9.1 Sort of transmission error

The Modbus RTU serial link transmission errors are categorized into the following 3 groups.

- Illegal query message
- Time out of serial link.
- Illegal processing

9.1.1 Illegal query message

When an illegal message is received, the query can not be performed and the following error response is returned.

Response format for illegal query

1 byte	1 byte	1 byte	2 bytes
Station address	Exception function	Subcode	Error check

- The station address is the same value as that in the query.
- The exception function of the response message = ("FC"(of the query)+128).
For example, if FC of the query equals 3, then the exception function of the response equals 131 (83H). [Exception Function = FC+128 = 3+128 =131].
- The following table defines the various "Subcode".

Subcode	Item		Remarks
1	Illegal FC		Received FC other than 3, 6, 8, 16.
2	Illegal address	Illegal function code	Received function code not yet used or a function code out of the range. <u>When an unused function code is included</u> - Function reading: 0 is read - Function writing: writing is neglected
		Illegal number of data	- "Number of variables to read"/"Number of write data" is not 1-16. - In the case of number of "Function code"+data exceeds the range of particular function code (example: up to 42 for F)
		The diagnostic code error in maintenance code	-The "Diagnostic code" was not 0.
3	Illegal data	Data range error	The "Write data" exceeds the writing range.
7	NAK	Link prior	If a link/LAN option card is installed, then writing to the "Command data" or "Operation command data" of the inverter is not allowed over the serial link RTU. Inverter control/operation is only allowed via the link/LAN option card.
		No write access	The link/LAN option card is writing to a function code. A function code write over the serial link RTU is not allowed until the write from the link/LAN option card is completed.
		Forbidden writing	Attempting to write to functions that are not allowed to be written over the serial link RTU, or not allowed to be written during inverter operation.

9.1.2 Serial link time out

- The RTU communication time out protocol is defined as three missing characters in a data flow. An example would be when the slave station does not return a response message. However, since PC10 can set the communication interruption time with a function code, this rule is neglected.
- There is a 500ms time out that starts when the Master completes transmitting a query message until a response is given by the slave station. If the slave does not respond within 500ms, then a communication retry action is performed with a longer time interval than 500ms. However, since the completion of writing to continuous functions may take more than 500ms, depending on the number and sort of the functions to be written, this time must be extended.

(Refer to "14.1 Response interval time" for details).

9.1.3 Illegal processing

Communication errors other than those mentioned in “9.1.1” and “9.1.2” above, are defined as illegal processing. The inverter will not return a response message.

- Physical errors (Parity, framing, overrun)
- CRC errors
- When a message length exceeds 41 bytes.

9.2 Action at transmission error

The inverter can be configured to take the appropriate actions once a transmission error or serial link time out error has occurred (See the table below).

To perform the appropriate error action it is necessary that normal character receiving has been performed once or more, and other means of operation (keypad, terminal, link/LAN option card) is performing correctly.

9.2.1 Action at occurring transmission error

Function code H32 can be used to select the desired inverter operation upon recognition of a transmission error.

H32	Action at occurring error		Remarks
0	Immediately force stop	Er8	
1	Continue operation until timer time (H33) has elapsed and then force stop	Er8	Continue operation until the timer times out, then either force a stop, or continue listening to the communications if re-established.
2	Continue operation until timer time (H33) has elapsed and then force stop, unless the communications has been re-established prior to the timer timing out.	Er8	
3	Continue operation. (Ride through) Listen to communications if re-established	Ride through (do not error)	

H33 is the error timer value used for time out (see H32): 0.0–60.0s

9.2.2 Factors of transmission error action

(1) Transmission error

The inverter performs the error action when detects the transmission errors 8 times continuously.

1) Condition of transmission errors

- In the case of the frame for own station become CRC error
- In the case of occurring receiving error (parity, framing, overrun)

(Because the receiving error is restricted once a frame, if an error occurred once, the errors occurred during the period till the first normal character will be received are not counted by the frame size amount. But when FC was abnormal, by 8 bytes are not counted because the frame length is not clear).

2) Clearing condition of transmission error counter

In the case wher CRC check of frame for own station or other stations is normal .

(2) Serial link time out error

The drive takes error action when the interruption of the communication through this protocol is detected.

1) Setting of communication interruption time (H38)

0s (no detection), 1–60s

2) Clearing condition for communication interruption detecting timer

In the case of CRC check of frame for own station or other stations are normal.

9.2.3 Description of action at occurring transmission error

In a case of H32=0 (Mode of immediate forced stop at occurring transmission error)

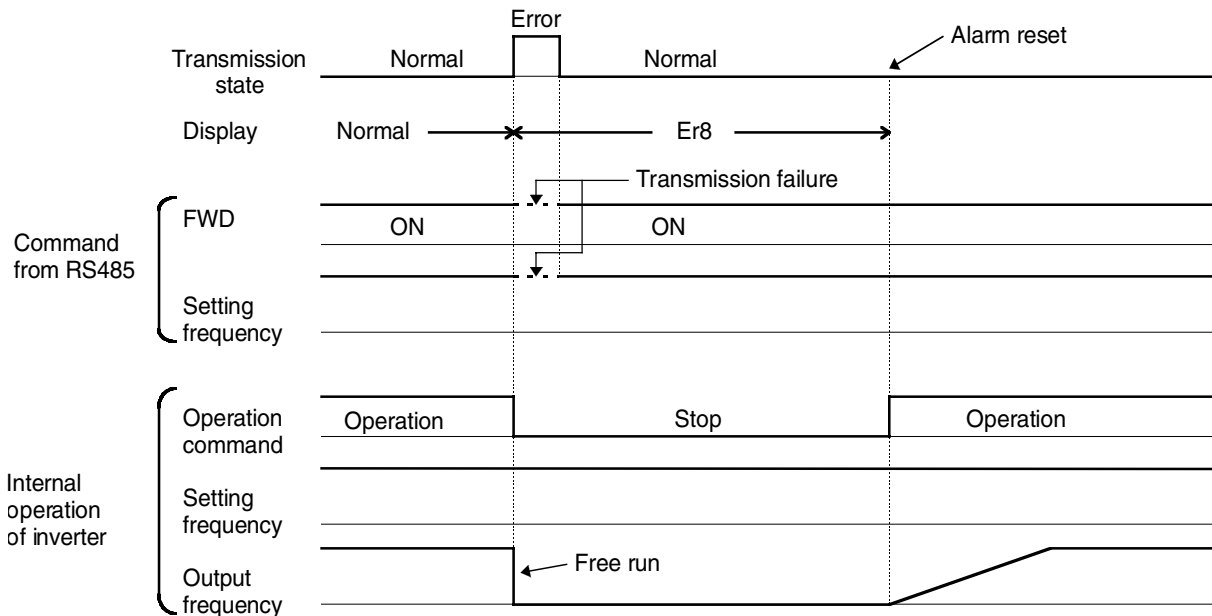

In a case of H32=1, H33=5.0s (Mode of immediate forced stop after 5 s at occurring transmission error)

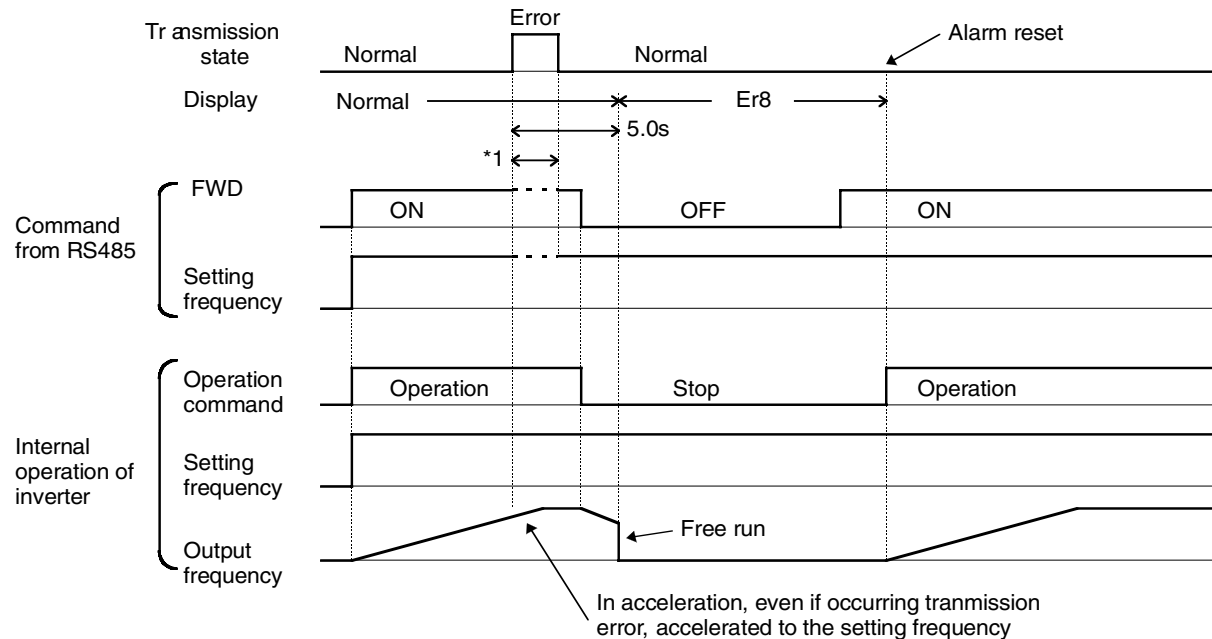

1) In a period until restoring the communication, the commands (command data and operation data) just before the error are kept.

In a case of H32=2, H33=5.0 s (The communication does not restore after elapsing 5 s from occurring transmission error, and inverter trips Er8)

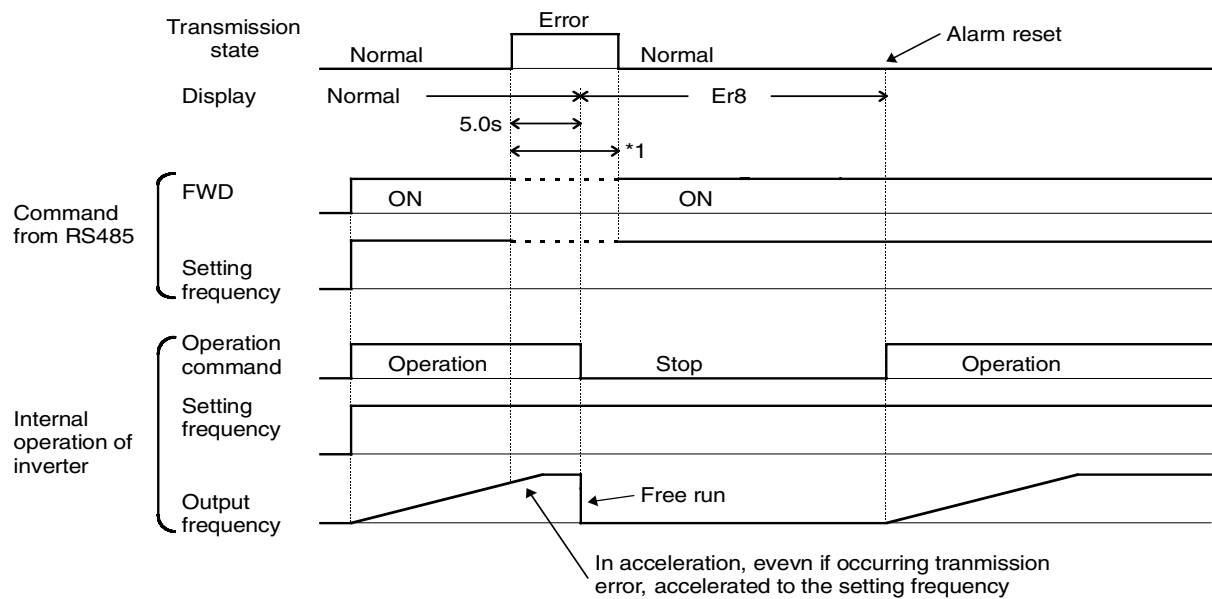

In a case of H32=2, H33=5.0 s (A transmission error occurs, but restored within 5 s)

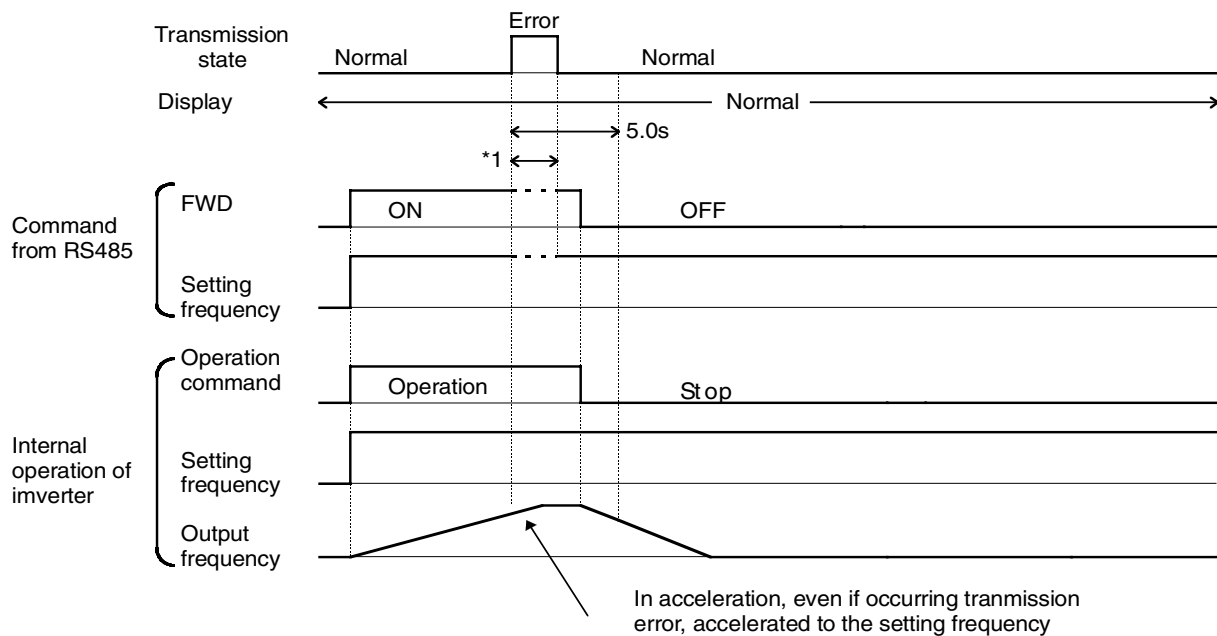

*1) In a period until restoring the communication, the commands (command data and operation data) just before the transmission error are kept.

In a case of H32=3 (Mode of operation continuation at occurring transmission error)

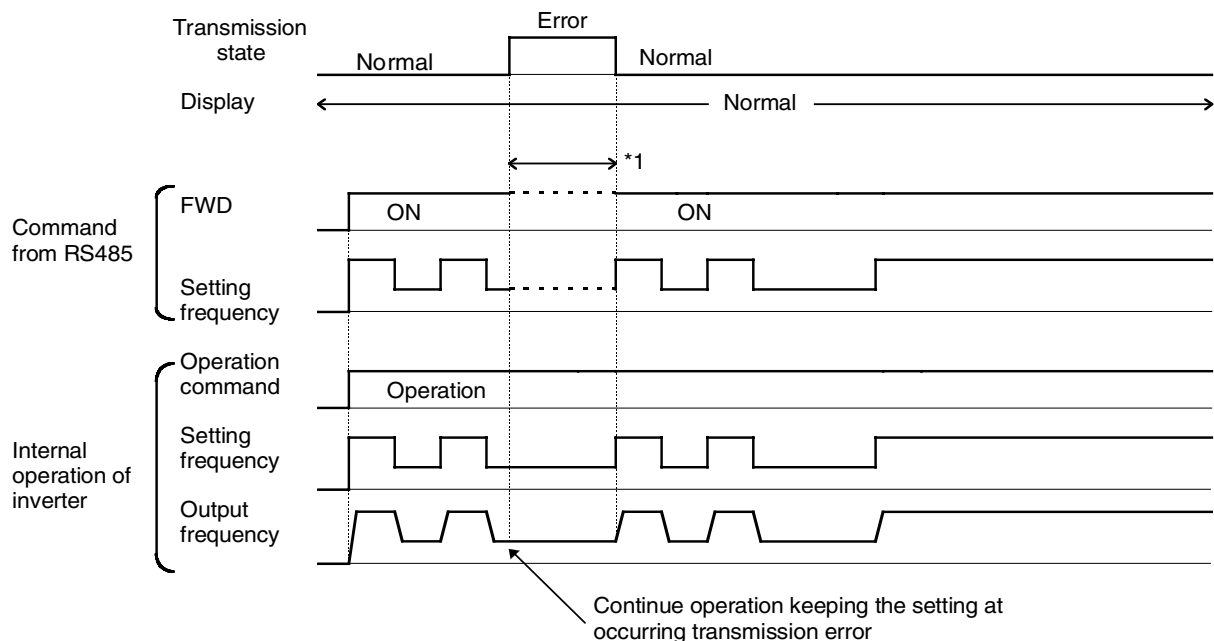

10. Functions specific for communication

To operate the inverters or to monitor the state via communication, the following functions are specifically available for communication in addition to the functions for parameter change of the inverters. These functions are adopted the common data format applicable to the types on and after 11 series, so that it is possible to access to the different type by the same program of the host side.

1.1. Command data1. Functions specific for communication

To operate the inverters or to monitor the state via communication, the following functions are specifically available for communication in addition to the functions for parameter change of the inverters. These functions are adopted the common data format applicable to the types on and after 11 series, so that it is possible to access to the different type by the same program of the host side.

10.1 Command data

Code	Name	Unit	Variable range	Min. unit	Read/Write
S01	Frequency command	-	- 20000_20000 (max. frequency at ±20000)	1	R/W
S05	Frequency command	Hz	0.00_400.00	0.01	R/W

R: Reading
W:Writing

Note:

- 1) The frequency command is handled as the synchronous frequency when provides a .speed regulator. .
- 2) If both S01 and S05 are set (data writing except 0), command of S01 become valid.
- 3) The data writing exceeding the setting range is impossible, and PC10 return "Data range error" response.
- 4) When the command data shown here are read, it is not the command data of actual action but the command data communicated before (The final command data can be obtained by reading of the monitoring data described later).

1) During the period until the communication restoring, the commands transmitted just before occurring of the transmission error (command data, operation data) are kept.

10.2 Operation command data

Code	Name	Unit	Variable range	Min. unit	Read/Write
S06	Operation command	-	Refer to the data format [14]	-	R/W

Note:

- 1) The frequency command is handled as the synchronous frequency when provides a .speed regulator. .
- 2) If both S01 and S05 are set (data writing except 0), command of S01 become valid.
- 3) The data writing exceeding the setting range is impossible, and PC10 return “Data range error” response.
- 4) When the command data shown here are read, it is not the command data of actual action but the command data communicated before (The final command data can be obtained by reading of the monitoring data described later).

Classification	Symbol	Name	Transmission	Terminal block	
Operation command	FWD/REV	FWD/REV command	Valid	Invalid	
Multi-function command	0_3	SS1, 2, 4, 8			Multi - step frequency
	4	RT1	Changeover of ACC/DEC time		
	5	HLD	Self hold signal	Invalid	
	6	BX	Free run command	Valid	
	7	RST	Alarm reset		
	8	THR	External alarm	Invalid	Valid
	9	Hz2/Hz1	Frequency setting 2/1	Valid	
	10	M2/M1	Motor 2/1	Invalid	Invalid
	11	DCBRK	DC braking command		
	12	TL2/TL1	Torque limit 2/1		
	13, 14	UP, DOWN	UP, DOWN command		
	15	WE-KP	Edit permission command	Valid	Valid
	16	Hz/PID	PID control cancel		
	17	IVS	Forward/reverse switching	Invalid	Invalid
18	LE	Link operation selection			

10.3 Function data

Code	Name	Unit	Variable range	Min. unit	Read/Write
S08	Acceleration time F07	s	0.1_3600.0	0.1	R/W
S09	Deceleration time F08	s	0.1_3600.0	0.1	R/W
S10	Torque limit level 1 (driving) F40	%	20.00_200.00 (P11S: 20.00_150.00), 999	1	R/W
S11	Torque limit level 2 (braking) F41	%	0.00, 20.00_200.00 (P11S: 20.00_150.00), 999	1	R/W

Note:

- 1) Writing to “out of range” is treated as an out of range error.
- 2) The acceleration and deceleration time S08 and S09 are assigned to “F07: Acceleration time ÇP” and “F08: Deceleration time ÇP” respectively.
- 3) The acceleration and deceleration time S08 and S09 are rounded down by four digits or more by the inverter itself. (ex: When 123.4s is written, it is rounded down to 123s.)
- 4) The torque limit level 1 and 2 of S10 and S11 are assigned to “F40: Torque limit ÇP (driving)” and “F41: Torque limit 1 (braking)” respectively.

10.4 Monitoring data

Code	Description	Unit	Range	Min. unit
M01	Frequency command (final command)	-	- 20000_20000 (max. frequency at ± 20000)	1
M05	Frequency command (final command)	Hz	0_400.00	0.01
M06	Actual frequency	-	- 20000_20000 (max. frequency at ± 20000)	1
M07	Actual torque value	%	- 200.00_200.00	0.01
M08	Torque current	%	- 200.00_200.00	0.01
M09	Output frequency	Hz	0.00_400.00	0.01
M10	Motor output (input electric power)	%	0.00_200.00	0.01
M11	Output current r. m. s.	%	0.00_200.00 (inverter rating at	0.01
M12	Output voltage r. m. s.	V	0.0_600.0	1
M13	Operation command (final command)	-	Refer to the data format [14]	-
M14	Operating state	-	Refer to the data format [16]	-
M15	Universal output terminal data	-	Refer to the data format [15]	-
M16	Fault memory 0	-		-
M17	Fault memory (1st prior)	-		
M18	Fault memory (2nd prior)	-		
M19	Fault memory (3rd prior)	-		
M20	Integrated operating time	h	0_65535	1
M21	DC link voltage	V	0_1000	1
M23	Type code	-	Refer to the data format [17]	-
M24	Drive capacity code	-	Refer to the data format [11]	-
M25	ROM version	-	0_64999	1
M26	Transmission error processing code	-	Refer to the data format [20]	-
M27	-	-	-	-
M31	-	-	-	-
M32	-	-	-	-
M33	-	-	-	-
M34	-	-	-	-
M35	-	-	-	-
M36	-	-	-	-
M37	-	-	-	-
M38	-	-	-	-
M39	-	-	-	-
M40	-	-	-	-
M41	-	-	-	-
M42	-	-	-	-
M43	-	-	-	-
M44	-	-	-	-
M45	-	-	-	-
M46	Life of main circuit capacitor.	%	0.0_100.0	0.1
M47	-	-	-	-
M48	Life of cooling fan.	h	0_65535	1

Note:

- 1) The frequency command with speed regulator is treated as the synchronous frequency..
- 2) The actual torque without speed regulator is treated as the calculated result of torque.

11. Function data format

The table below defines the data formats for various inverter function data. The data shall be prepared according to the following data format specifications. The inverter's instruction manual should be referred to for the data units and range.

11.1 List of function data format

Code	Name	Data format	Code	Name	Data format
F00	Data protection	[1]	E01	X1 terminal function	[1]
F01	Frequency command 1	[1]	E02	X2 terminal function	[1]
F02	Operation method	[1]	E03	X3 terminal function	[1]
F03	Maximum output frequency 1	[1]	E04	X4 terminal function	[1]
F04	Base frequency 1	[1]	E05	X5 terminal function	[1]
F05	Rated voltage 1	[1]	E06	-	-
F06	Maximum output voltage 1	[1]	E07	-	-
F07	Acceleration time 1	[12]	E08	-	-
F08	Deceleration time 1	[12]	E09	-	-
F09	Torque boost 1	[1]	E10	Acceleration time 2	[12]
F10	Electronics thermal overload relay 1 (selection)	[1]	E11	Deceleration time 2	[12]
F11	Electronics thermal overload relay 1 (level)	[19]	E12	-	-
F12	Electronics thermal overload relay 1 (thermal time constant)	[3]	E13	-	-
F13	Electronics thermal overload relay (braking resistor)	[1]	E14	-	-
F14	Restart after momentary power failure (selection)	[1]	E15	-	-
F15	Frequency limit (upper)	[1]	E16	Torque limit 2 (driving)	[1]
F16	Frequency limit (lower)	[1]	E17	Torque limit 2 (braking)	[1]
F17	Gain (frequency setting signal)	[3]	E20	Y1 terminal function	[1]
F18	Bias frequency	[2]	E21	Y2 terminal function	[1]
F20	DC braking (starting frequency)	[3]	E22	-	-
F21	DC braking (braking level)	[1]	E23	-	-
F22	DC braking (braking time)	[3]	E24	-	-
F23	Starting frequency	[3]	E25	-	-
F24	Starting frequency (holding time)	[3]	E29	Frequency level detection delay	[12]
F25	Stopping frequency	[3]	E30	Frequency arrival (FAR) (detecting width)	[3]
F26	Motor sound (carrier frequency)	[1] *1	E31	Frequency detection (operation level)	[1]
F27	Motor sound (sound tone)	[1]	E32	Frequency detection (FDT) (hysteresis width)	[3]
F29	FMA and FMP terminals	[1]	E33	Overload early warning (selection)	[1]
F30	FMA terminal (voltage adjust)	[1]	E34	Overload early warning 1 (level)	[19]
F31	FMA terminal (function selection)	[1]	E35	Overload early warning (timer time)	[3]
F33	FMP terminal (pulse rate multiplier)	[1]	E36	-	-
F34	FMP terminal (voltage adjust)	[1]	E37	-	-
F35	FMP terminal (function selection)	[1]	E40	Display coefficient A	[12]
F36	30Ry action mode	[1]	E41	Display coefficient B	[12]
F40	Torque limit 1 (driving)	[1]	E42	Display filter	[3]
F41	Torque limit 1 (braking)	[1]	E43	-	-
F42	Torque vector control 1	[1]	E44	-	-
			E45	-	-
			E46	-	-
			E47	-	-

*1) 0.75 Hz are treated as 0.

Code	Name	Data format	Code	Name	Data format
C01	Jump frequency 1	[1]	H11	Deceleration mode	[1]
C02	Jump frequency 2	[1]	H12	Instantaneous overcurrent limit	[1]
C03	Jump frequency 3	[1]	H13	Auto-restart (restart time)	[3]
C04	Jump frequency (width)	[1]	H14	Auto-restart (frequency fall rate)	[5]
C05	Multi-step frequency 1	[5]	H15	-	-
C06	Multi-step frequency 2	[5]	H16	-	-
C07	Multi-step frequency 3	[5]	H18	-	-
C08	Multi-step frequency 4	[5]	H19	-	-
C09	Multi-step frequency 5	[5]	H20	PID control (mode selection)	[1]
C10	Multi-step frequency 6	[5]	H21	PID control (feedback signal selection)	[1]
C11	Multi-step frequency 7	[5]	H22	PID control (P-gain)	[5]
C12	Multi-step frequency 8	[5]	H23	PID control (I-time)	[3]
C13	Multi-step frequency 9	[5]	H24	PID control (D-time)	[5]
C14	Multi-step frequency 10	[5]	H25	PID control (feedback filter)	[3]
C15	Multi-step frequency 11	[5]	H26	PTC thermistor (mode selection)	[1]
C16	Multi-step frequency 12	[5]	H27	PTC thermistor (level)	[5]
C17	Multi-step frequency 13	[5]	H28	Droop control	[4]
C18	Multi-step frequency 14	[5]	H30	Serial link operation (function selection)	[1]
C19	Multi-step frequency 15	[5]	H31	Modbus-RTU (address)	[1] *2
C20	-	-	H32	Modbus-RTU (selection on error)	[1] *2
C21	Pattern operation	[1]	H33	Modbus-RTU (timer)	[3] *2
C22	Stage 1	[12]	H34	Modbus-RTU (baud rate)	[1] *2
C23	-	-	H35	Modbus-RTU (data length)	[1] *2
C24	-	-	H36	Modbus-RTU (parity check)	[1] *2
C25	-	-	H37	Modbus-RTU (stop bit)	[1] *2
C26	-	-	H38	Modbus-RTU (no response error detection time)	[1] *2
C27	-	-	H39	Modbus-RTU (response interval)	[5] *2
C28	-	-	H40	Maximum temperature of heat sink	[1]
C30	Frequency setting	[1]	H41	Maximum effective current	[19]
C31	Analog input offset (terminal 12)	[4]	H42	Main circuit capacitor life	[3]
C32	Analog input offset (terminal C1)	[4]	H43	Cooling fan operation time	[1]
C33	Analog setting signal filter	[5]	H44	Inverter ROM version	[1]
P01	Motor 1 (number of poles)	[9]	H45	Keypad panel ROM version	[1]
P02	Motor 1 (capacity)	[5]	H46	Option ROM version	[1]
P03	Motor 1 (rated current)	[19]	A01	Maximum output frequency 2	[1]
P04	Motor 1 (auto-tuning)	[21] *3	A02	Base frequency 2	[1]
P05	Motor 1 (on-line tuning)	[1]	A03	Rated voltage 2	[1]
P06	Motor 1 (no-load current)	[19]	A04	Maximum output voltage 2	[1]
P07	Motor 1 (%R1)	[5]	A05	Torque boost 2	[1]
P08	Motor 1 (%X)	[5]	A06	Electronics thermal 2 (selection)	[1]
P09	Motor 1 (slip compensation control)	[5]	A07	Electronics thermal 2 (level)	[19]
P10	Motor 1 (Slip compensation response time 1)	[5]	A08	Electronics thermal 2 (thermal time constant)	[3]
			A09	Torque vector control 2	[1]
H01	Total operation time	[1]	A10	Motor 2 (number of poles)	[9]
H02	Trip history	-	A11	Motor 2 (capacity)	[5]
H03	Data initializing	[1] *3 *4	A12	Motor 2 (rated current)	[19]
H04	Retry (times)	[1]	A13	Motor 2 (tuning)	[21] *3
H05	Retry(reset interval)	[1]	A14	Motor 2 (on-line tuning)	[1]
H06	Fan stop operation	[1]	A15	Motor 2 (no-load current)	[19]
H07	ACC/DCC pattern (mode select)	[1]	A16	Motor 2 (%R1 setting)	[5]
H08	-	-	A17	Motor 2 (%X setting)	[5]
H09	Start mode	[1]	A18	Motor 2 (slip compensation amount)	[5]
H10	Energy-saving operation	[1]	A19	Motor 2 (Slip compensation response time 2)	[5]

*1) 999 is treated as 03E7H (99.9).

*2) The writing from the transmission is impossible.

*3) In the case of the continuous function writing of FC=16, if number of the writing data are 2 or more, it is impossible to write the data other than 0.

*4) When the data are initialized, the transmission may not be continued because the data of the H31_H39 related to communication are also returned to the initial value

Code	Name	Data format	Code	Name	Data format
o01	-	-	M01	Frequency command (final command)	[2]
o02	-	-	M05	Frequency command (final command)	[5]
o03	-	-	M06	Actual frequency	[2]
o04	-	-	M07	Actual torque value	[6]
o05	-	-	M08	Torque current	[6]
o06	-	-	M09	Output frequency	[5]
o07	-	-	M10	Motor output	[5]
o08	-	-	M11	Output current effective value	[5]
o09	-	-	M12	Output voltage effective value	[3]
o10	-	-	M13	Operation command (final command)	[14]
o11	-	-	M14	Operating state	[16]
o12	-	-	M15	Universal output terminal data	[15]
o13	-	-	M16	Fault memory 0	[10]
o14	-	-	M17	Fault memory (1st prior)	[10]
o15	-	-	M18	Fault memory (2nd prior)	[10]
o16	-	-	M19	Fault memory (3rd prior)	[10]
o17	-	-	M20	Integrated operating time	[1]
o18	-	-	M21	DC link voltage	[1]
o19	-	-	M23	Type code	[17]
o20	-	-	M24	Capacity code	[11]
o21	-	-	M25	ROM version	[1]
o22	-	-	M26	Transmission error processing code	[20]
o23	-	-	M27	-	-
o24	-	-	M31	-	-
o25	-	-	M32	-	-
o26	-	-	M33	-	-
o27	-	-	M34	-	-
o28	-	-	M35	-	-
o29	-	-	M36	-	-
			M37	-	-
			M38	-	-
			M39	-	-
S01	Frequency command	[2]	M40	-	-
S05	Frequency command	[5]	M41	-	-
S06	Operation command	[14]	M42	-	-
S07	-	-	M43	-	-
S08	Acceleration time	[3]	M44	-	-
S09	Deceleration time	[3]	M45	-	-
S10	Torque limiter level 1	[5] *1	M46	Life of main circuit capacitor	[3]
S11	Torque limiter level 2	[5] *1	M47	-	-
S12	-	-	M48	Life of cooling fan	[1]

*1) 999 is handled as 7FFF_H

12. Data format specification

All data within the data field of communication frame shall be represented by 16 bits length.

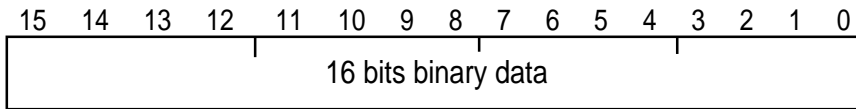

Data format [1] Integer data (Positive): Min. unit 1

Example) If F15 (Frequency limiter, upper limit)= 60Hz

Since $60 = 003C_H$

00H	3CH
-----	-----

Data format [2] Integer data (Positive, negative): Min. unit 1

Example) If being -20

Since $-20 = FFEC_H$

FFH	ECH
-----	-----

Data format [3] Decimal data (Positive): Min. unit 0.1

Example) If F17 (gain frequency setting signal) = 100.0%

Since $100.0 \times 10 = 1000 = 03E8_H$

03H	E8H
-----	-----

Data format [4] Decimal data (Positive, negative): Min. unit 0.1

Example) If C31 (Analog input offset adjust, terminal12) = - 5.0%

Since $- 5.0 \times 10 = - 50 = FFCE_H$

FFH	CEH
-----	-----

Data format [5] Decimal data (Positive): Min. unit 0.01

Example) If C05 (multi-step frequency 1) = 50.25Hz

Since $50.25 \times 100 = 5025 = 13A1$

13H	A1H
-----	-----

Data format [6] Decimal data (Positive, negative): Min. unit 0.01

Example) If M07 (actual torque value)= - 85.38%

Since $- 85.38 \times 100 = - 8538 = DEA6_H$

DEH	A6H
-----	-----

Data format [7] Decimal data (Positive): Min. unit 0.001

Example) If o05 (follow - up side ASR 1 constant) = 0.105s

Since $0.105 \times 1000 = 105 = 0069_H$

00H	69H
-----	-----

Data format [8] Decimal data (Positive, negative): Min. unit 0.001

Example) If being -1.234

Since $- 1.234 \times 1000 = - 1234 = FB2E_H$

FBH	2EH
-----	-----

Data format [9] Integral data (Positive): Min. unit 2

Example) If P01 (Motor 1 number of poles) = 2pole

Since $2 = 0002_H$

00H	02H
-----	-----

Data format [10] Alarm code

Code	Description	Code	Description
0	No alarm	---	-
1	Overcurrent, during acceleration (INV output)	OC1	31 Memory error
2	Overcurrent, during deceleration (INV output)	OC2	32 Keypad panel transmission error
3	Overcurrent, during steady state operation (INV output)	OC3	33 CPU error
-	-	-	34 Option communication error
6	Overvoltage, during acceleration	OU1	35 Option error
7	Over voltage, during deceleration	OU2	36 PL error
8	Overvoltage, during steady state operation	OU3	37 Output wiring error
10	DC undervoltage	LU	38 RS485 communication error
11	Power supply open phase	Lin	
-	-	-	
16	Output wiring error	Er7	
17	Overheat, heat sink, inverter	OH1	
18	Overheat, outside thermal	OH2	
-	-	-	
22	Overheat, DB resistor	dbH	
23	Overload, motor 1	OL1	
24	Overload, motor 2	OL2	
25	Overload, inverter	OLU	
-	-	-	

Example) If overvoltage, during acceleration (OU1)

Since $6 = 0006_H$

00H	06H
------------	------------

Data format [11] Capacity code

Code	Capacity (HP)	Code	Capacity (HP)	Code	Capacity (HP)
12	0.125				
25	0.25				
50	0.5				
100	1				
200	2				
300	3				
500	5				
750	7.5				
1000	10				

Example) If being 10 Hp

Since $10 \times 100 = 1000 = 03E8_H$

03H	E8H
------------	------------

Data format [12] Index data (ACC/DEC time, display coefficient)

15	14	13	12	11	10	9	8	7	6	5	4	3	2	1	0
Polarity	0	0	0	Index portion			Data portion								
	Not yet used			0: 0.01		x	001 999			(0.00 9.99)					
				1: 0.1		x	100 999			(10.0 99.9)					
				2: 1		x	100 999			(100 999)					
				3:10		x	100 999			(1000 9990)					

0: Positive (+)
1: Negative (-)

Example) If F07 (acceleration time 1) = 20.0 s

Since $20.0 = 0.1 \times 200 > 0400_H + 00C8_H = 04C8_H$

04H	C8H
------------	------------

Data format [13] Pattern operation

15	14	13	12	11	10	9	8	7	6	5	4	3	2	1	0
Direction of rotation	0	Time		Index portion			Data portion								
	Not yet used			0: 0.01		x	001 999			(0.00 9.99)					
				1: 0.1		x	100 999			(10.0 99.9)					
				2: 1		x	100 999			(100 999)					
				3:10		x	100 999			(1000 9990)					

0: Forward rotation
1: Reverse rotation

0: 1st ACC/DEC time
2: 2nd ACC/DEC time
3: 3rd ACC/DEC time
4: 4th ACC/DEC time

Example) If C22 (Stage 1) = 10.0s R2 (10s, reverse rotation, acceleration time 2/deceleration time 2)

Since $10.0 = 0.1 \times 100 > 9000_H + 0400_H + 0064_H = 9466_H$

94H	64H
------------	------------

Data format [14] Operation Command

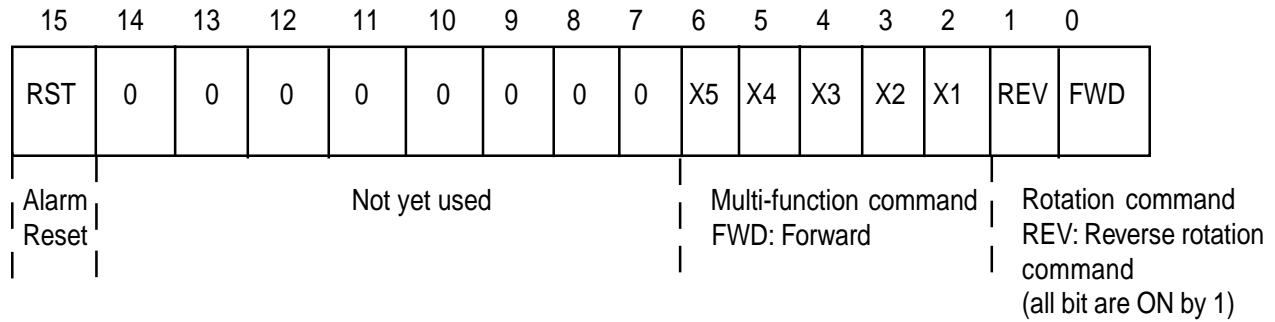

Example) If S06 (operation command) = FWD, X1 and X5 = ON
 Since $0000\ 0000\ 0100\ 0101_b = 0045_H$

00H	45H
------------	------------

Data format [15] Universal output terminal

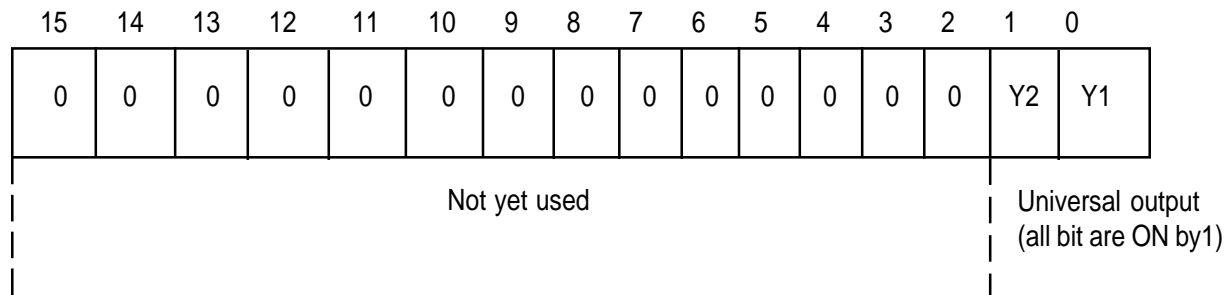

Example) If M15 (Universal output terminal) = Y1 and Y2 = ON
 Since $0000\ 0000\ 0000\ 0011_b = 0011_H$

00H	03H
------------	------------

Data format [15] Operation Command

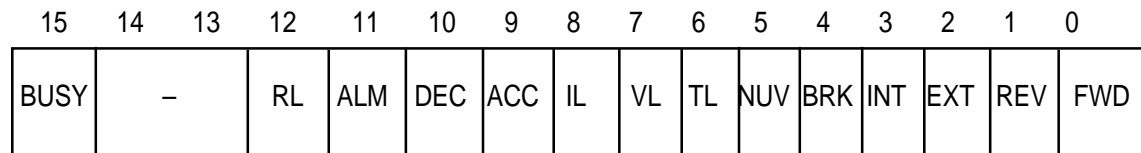

(All bit are ON or active by 1)

- | | |
|---|---------------------------------------|
| FWD: Under forward operation | IL: Under current limiting |
| REV: Under reverse operation | ACC: Under acceleration |
| EXT: Under DC braking (or under pre-excitation) | DEC: Under deceleration |
| | ALM: Lump alarm |
| INT: Drive trip | RL: Transmission valid |
| BRK: Under braking | |
| NUV: DC link voltage is established (undervoltage at 0) | BUSY: Under data writing (processing) |
| TL: Under torque limiting | |
| VL: Under voltage limiting | |

Example) Omission (Monitoring method is similar as in the formats [14] and [15].)

Data format [16] Type Code

15 14 13 12 11 10 9 8 7 6 5 4 3 2 1 0

Type	Generation	Series	Voltage series
------	------------	--------	----------------

Code	Type	Generation	Series	Voltage series
1	-	11	-	-
2	-	-	-	200V single phase
3	-	-	-	200V three phase
4	E	-	-	400V three phase
5	-	-	For USA	-
6	-	-	-	-

Data format [17] Code setting (1 4 figures)

15 14 13 12 11 10 9 8 7 6 5 4 3 2 1 0

Data 4	Data 3	Data 2	Data 1
--------	--------	--------	--------

Example) If o22 (Ai function selection)=123

Since $123 = 0123_H$

01H	23H
------------	------------

Data format [18] Current value [Decimal data (positive): Min unit 1.01.]

Note 1) It is impossible to write the value which exceeds 99.99A in 10 Hp or less.

Example) If F11 (electronics thermal overload relay 1 level) = 3.60A (1 Hp)

Since $3.60 \times 100 = 360 = 0168_H$

01H	68H
------------	------------

Data format [19] Transmission error code

Code	Description	Code	Description
1	FC (function code) error	71	CRC error (no response)
2	Illegal address	72	Parity error (no response)
3	Illegal data (Data range error)	73	Other errors (no response) - Framing error - Overrun error - Bufferfull error
7	NAK - Priority for link - No right for writing error - Forbidden writing error		

Example) If illegal address

Since 2 = 0002_H

00H	02H
------------	------------

Data format [20] Auto Tuning

15	14	13	12	11	10	9	8	7	6	5	4	3	2	1	0
0	0	0	0	0	0	REV	FWD	0	0	0	0	0	0	0	Data portion

Not yet used

0 2

0: Without forward rotation command.

1: With forward rotation command.

0: Without reverse rotation command.

1: With reverse rotation command.

NOTE1) when the host reads it, 0 is read always.

NOTE2) When only one of bits either are set in "1", the operation becomes effective.

Example) If P04 (motor 1 auto - tuning)=1: Forward rotation

Since 0000 0001 0000 0001_b=0101_H

01H	01H
------------	------------

13. Changeover of communication

In order to perform the drive operation through the communication (by command data/operation data) the communication shall be switched to valid under the condition that 1–3 of ÅH30ÅFLink function (selection)Åh has being selected (The reading and writing of function data/functions are possible at any time regardless valid or invalid of the communication).

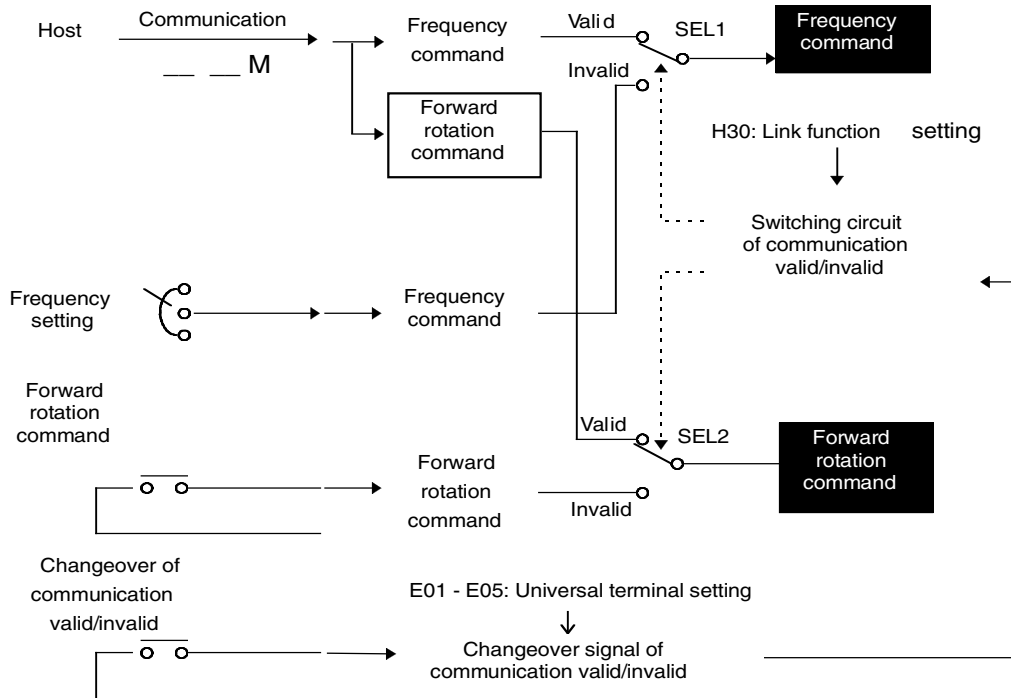

13.1 Changeover method for valid/invalid of communication

The change over for of the communication valid/invalid can be performed by universal input terminals (X1-X5 terminals) on the inverter. However, it is necessary to set the inverter’s universal input terminals (E01–E05: X1–X5 terminals) to link operation selection (data 18). If universal input terminals have not being set to the link operation selection, the communication becomes valid automatically.

Input terminals	State
OFF	Communication invalid mode
ON	Communication valid mode

Note:

- Since all memories are initialized when power is switched on, the command data/operation data transmitted through communication must be write again from the upstream units.
- Even when the communication is invalid, the writing of command data/operation data are valid, but they are not reflected by SEL1/SEL2. The changing over without shock is possible by the way where the data is set during the communication invalid mode at first, then the mode is changed over to the communication valid mode.

13.2 Link function (function selection)

The setting (valid/invalid) during the communication valid period is possible individually for command data/operation data, by the setting of "H30: Link function". (Making the communication always valid in all time by no setting of universal input terminals, and changing over the H30 data valid/invalid, changeover of the communication valid/invalid is possible similarly to the changeover by universal input terminals).

Link function	During communication is valid		During communication is invalid
	SEL1 (Command data)	SEL2 (Operation data)	SEL1, SEL2
0	Invalid	Invalid	Invalid
1	Valid	Invalid	
2	Invalid	Valid	
3	Valid	Valid	

14. Response time

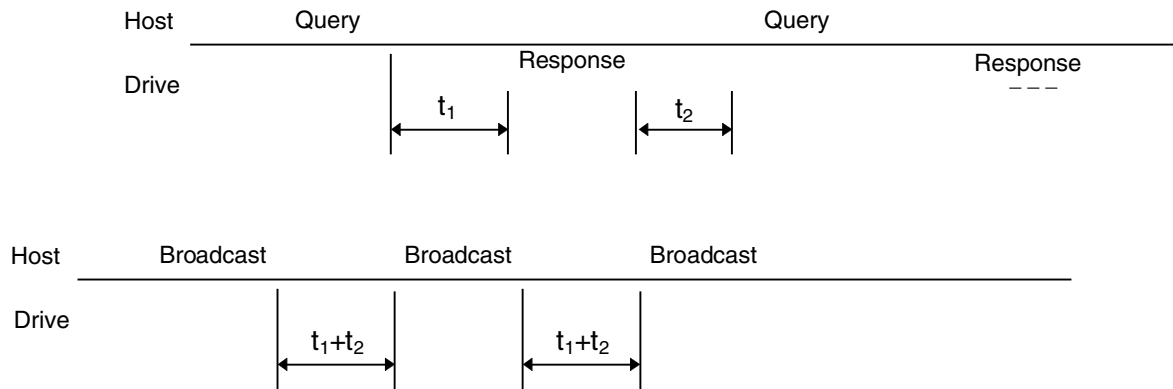

14.1 Response interval time

The time interval from receiving a query of the host such as PC to commencement of response sending can be set. By means of the response interval time setting, it is possible to match the sending timing even with the host having slow processing speed.

- Response interval time (t_1)

t_1 : Response interval time setting (H39)+ t_d

t_d : Processing time of drive

t_d	FC	Processing	Remarks
$\leq 30\text{ms}$	3	Reading of function	
$\leq 10\text{ms}$	6	Writing to single function	S01_S06: Command
$\leq 100\text{ms}$			Except S01_S06, H03, P02, A11
$\leq 500\text{ms}$			P02, A11: Motor capacity
$\leq 5\text{s}$			H03: Data initializing
$\leq 10\text{ms}$	8	Maintenance code	
$\leq 1.6\text{s}$	16	Writing to continuous function	When the data is 16 pieces (100ms \times 16) Refer to the above if S01_S06, H03, P02, A11 are included.

Note:

- 1) In the case of broadcast, the setting of response interval is invalid (0 s) because the inverter does not return the response.
- 2) If auto-tuning of P04 and A13 is written by single/continuous functions, no response returns till completion of the tuning or occurring of Er7. If tuning starting is commanded by the terminal blocks or FWD/REV on the keypad panel during the invalid state of communication, take care that the waiting state continues till receiving

14.2 Receiving preparation completion time

The time from returning of response by the inverter to the completion of receiving preparation of input port is defined as the receiving preparation completion time.

t_2 : Receiving preparation completion time $\leq 10\text{ms}$
(of the starting command).

13. Compliance with standards

13.1 UL/cUL standards

13.1.1 General

The UL standards stand for Underwriters Laboratories Inc. and they are safety standards aiming at prevention of fire and other accidents in the United States, thereby providing protection for operators, service personnel and other persons.

The cUL standards are established by UL to be in compliance with the CSA standards. The effect on products certified for the cUL standards is equal to that of products certified for the CSA standards.

13.1.2 Precautions

When using UL/cUL certified products, refer to “Compliance with UL/cUL standards” on page vi and vii in the introduction.

13.2 Electromagnetic Compatibility (EMC) [Available only for products with CE mark]

13.2.1 General

The CE mark indicated on the PC10 series refers to the European minister directorate directive 89/336/EEC concerning the environmental electromagnetic compatibility, EMC. Other directives are not included.

The CE mark on the drive does not attest that the entire machine or system housing complies with the EMC directive. Therefore application of the CE mark to the entire machine or system will be done at the responsibility of the manufacturer of the machine. This is because:

- 1) The CE mark attached on our product supposes operation of the product under “certain conditions”. Satisfaction of the conditions is up to the manufacturer of the machine.
- 2) Generally speaking, various devices are used in a machine or system in addition to the drive. Therefore consideration of the entire machine or system must be addressed by the manufacturer of the machine.

The EMC directive includes immunity to incoming noise and emission of outgoing noise. The general purpose inverter houses an internal element switching at high speed which generates electrical noise.

EMC product standard EN61800-3/1996

Immunity : **Second environment** [Industrial environment]

Emission : **First environment** [Domestic environment for 230V Single phase, 460V Three phase]

Emission : **Second environment** [Industrial environment for 230V Three phase]

Above-mentioned “certain conditions” include installation of a dedicated RFI filter in a metallic control panel.

13.2.2 RFI filter

Please contact the drive distributor for the recommended RFI filter.

Remark : Refer to the RFI filter manual for details.

To minimize the conducted radio disturbance in the power distribution system, the length of the motor cables should be as short as possible. And it is user's responsibility to confirm that the apparatus, into which the drive is installed, conforms to the EMC directive when longer motor cables are used or other installation conditions are different from those described in the recommended RFI filter manual.

13.2.3 Recommended Installation Instructions

These instructions must be followed to conformed to the EMC Directive.

Follow the usual safety procedures when working with electrical equipment. All electrical connections to the filter, Inverter and motor must be made by a qualified electrical technician.

(Refer to Fig. 13-2-1)

- 1) Use the correct recommended filter .
- 2) The back panel of the cabinet should be prepared for the mounting dimensions of the filter. Care should be taken to remove any paint etc. from the mounting holes and face area of the panel. This will ensure the best possible grounding of the filter.

- 3) Fix the RFI filter to the cabinet and securely mount the drive on it with screws.
(230V Three phase filter is separated type)
- 4) Connect the supply mains to the RFI filter input terminal (LINE) and the ground terminal on the filter to ground. Then connect the filter output (LOAD) to the drive input terminal with shortest possible cable. Cover the hole in the cabinet with the shield of the cable and verify that the shield is electrically connected to the cabinet.
- 5) Connect the drive output to motor with the shielded cable.
- 6) Use shielded cable for the control circuit wiring. This shield also has to be securely grounded. It is important that all wire lengths are kept as short as possible and that incoming mains and outgoing motor cables are kept well separated.

Three-phase power supply

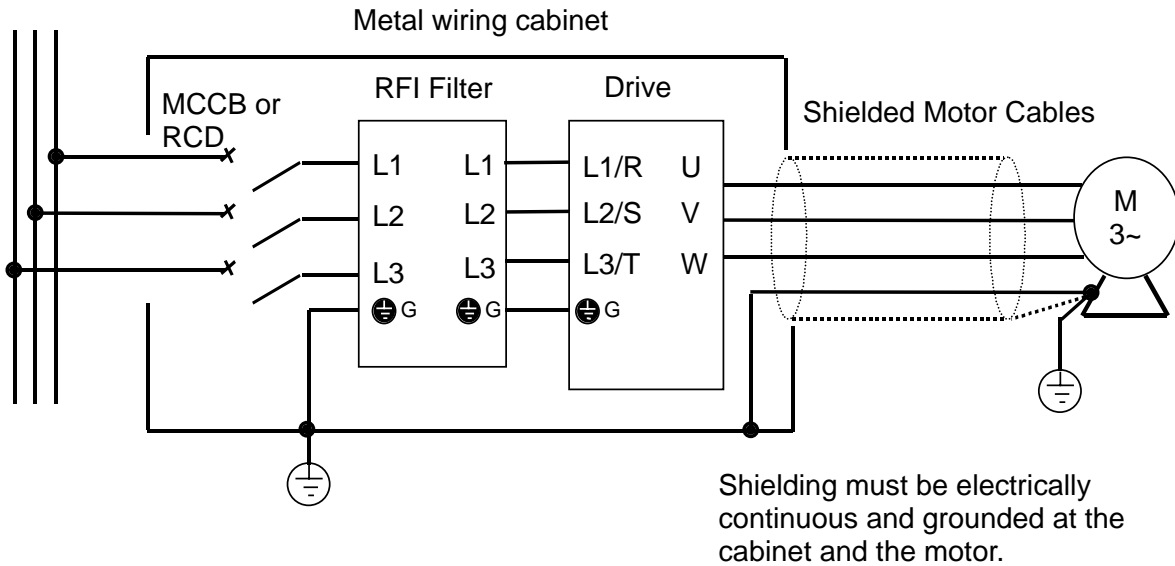

Single-phase power supply

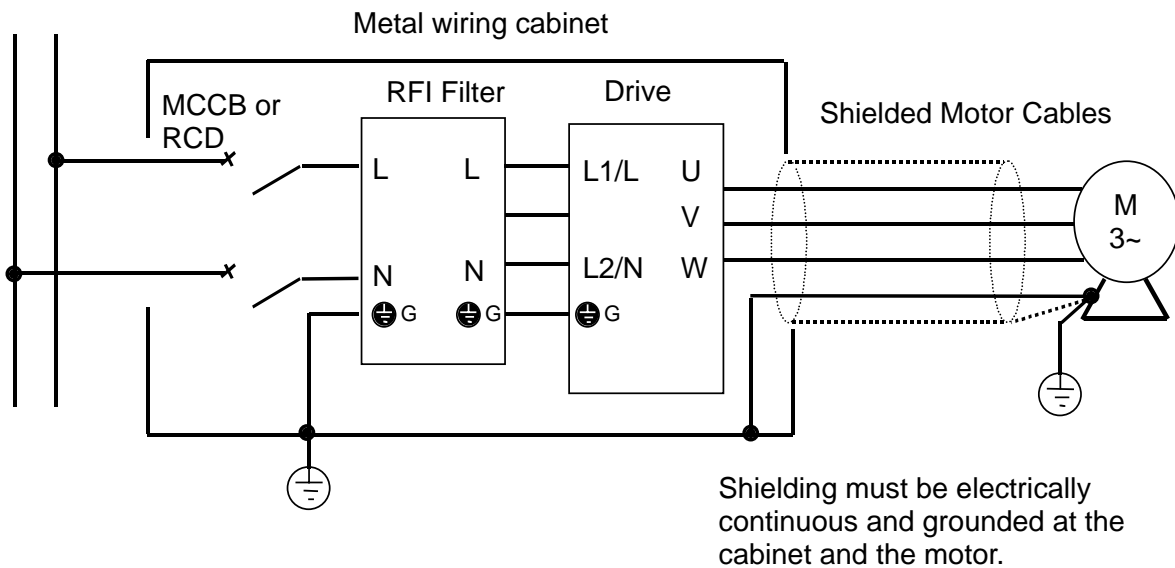

Table 12-2-1 RFI filter

Filter Part No.	EFL040E117 (EFL-0.4E11-7)	EFL075E117 (EFL-0.75E11-7)	EFL220E117 (EFL-2.2E11-7)
230V Single Phase Input Drive [HP]	1/8, 1/4, 1/2 HP	1 HP	2, 3 HP
Rated Current	6.5A	18A	29A
Rated Voltage	AC200 - 240V 50/60Hz		
Dimensions L,W,H (mm)	7.44x2.8x1.42 (189x71x36)	7.52x4.33x1.42 (191x110x36)	7.52x6.85x1.61 (191x174x41)
Mount Dims X,Y(mm)	2.17x7.01 (55x178)	3.15x6.5 (80x165)	5.71x6.5 (145x165)
Wire Length Lw (mm)	5.91 (150)	7.09 (180)	7.48 (190)
Inverter Fixings	M4		
Filter Fixings	M4	M5	
Weight [lb]	1.1	1.8	2.6
Fig.	Fig. 13-2-2		

Filter Part No.	EFL075E114 (EFL-0.75E11-2)	EFL220E114 (EFL-2.2E11-4)	EFL400E114 (EFL-4.0E11-4)	EFL750E114 (EFL-7.5E11-4)
460V Three Phase Input Drive [HP]	1/2, 1 HP	2, 3 HP	5HP	7.5 10HP
Rated Current	5A	10A	15A	30A
Max. Rated Voltage	AC380 - 480V 50/60 Hz			
Dimensions L,W,H (mm)	7.52x4.33x1.61 (191x110x41)		7.52x6.85x1.81 (191x174x46)	10.9x7.17x1.97 (278x182x50)
Mount Dims X,Y (mm)	3.15x6.5 (80x165)		5.71x6.5 (145x165)	5.71x9.92 (145x252)
Wire Length Lw (mm)	7.09 (180)	7.48 (190)		10.63 (270)
Inverter Fixings	M4			M5
Filter Fixings	M5			
Weight [lb]	1.8	2.2	3.1	4.2
Fig.	Fig. 13-2-3			

Filter Part No.	EFL075E112 (EFL-0.75E11-2)	EFL400E112 (EFL-4.0E11-2)	EFL750E112 (EFL-7.5E11-2)
230V Three Phase Input Drive [HP]	1/8, 1/4, 1/2, 1HP	2, 3, 5 HP	7.5, 10 HP
Rated Current	6.5A	26A	53A
Max. Rated Voltage	AC200 - 240V 50/60Hz		
Dimensions L,W,H (mm)	5.31x2.95x2.36 (135x75x60)	6.3x3.94x3.15 (160x100x80)	8.11x5.39x4.53 (206x137x115)
Mount Dims X,Y(mm)	2.36x4.82 (60x122.5)	3.15x5.71 (80x145)	3.94x7.28 (100x185)
Earth terminal	M4	M5	M6
Filter Fixings	M4		M5
Weight [lb]	1.1	2.4	5.9
Fig.	Fig. 13-2-4		

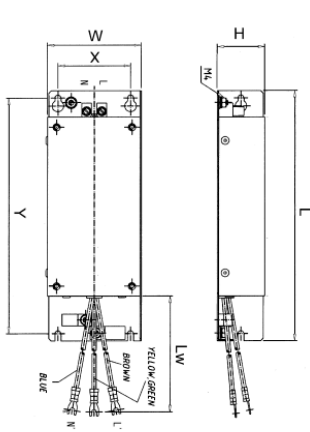

Fig. 13-2-2

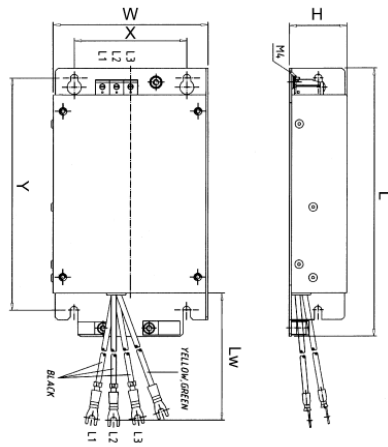

Fig. 13-2-3

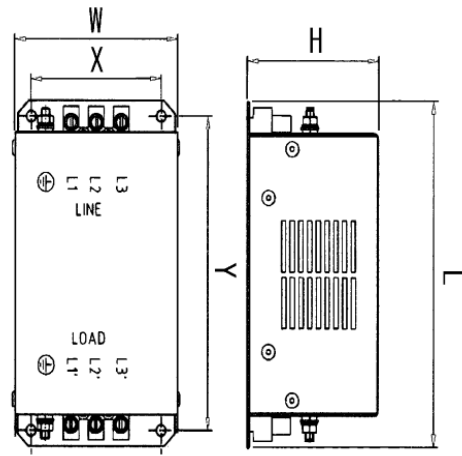

Fig. 13-2-4

13.3 Compliance with low voltage directive in EU [Available only for products with TÜV or CE mark]

13.3.1 General

The general purpose inverter is applicable for the low voltage directive in EU. Compliance of the PC10 series with EN 50178/1997 has been obtained from a testing organization in EU and compliance with the low voltage directive is assured.

13.3.2 Precautions

Refer to “Compliance with low voltage directive in EU” on pages iv and v in the introduction when using this product as one complying with the low voltage directive in EU.

5580 Enterprise Parkway, Fort Myers, Florida 33905 • Telephone (941) 693-7200 • Fax (941) 693-2431

REV: 0401
P/N: 027-PC1001
(INR-S147-0684-E)
© 2001 Saftronics