

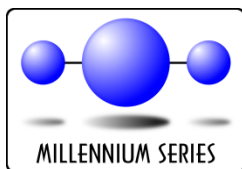

INDUSTRIAL CONTROL COMMUNICATIONS, INC.

ETH-1000 Multiprotocol Ethernet / RS-485 Gateway





ETH-1000 User's Manual

Part Number 10724

Printed in U.S.A.

©2016 Industrial Control Communications, Inc.

All rights reserved

NOTICE TO USERS

Industrial Control Communications, Inc. reserves the right to make changes and improvements to its products without providing notice.

Industrial Control Communications, Inc. shall not be liable for technical or editorial omissions or mistakes in this manual, nor shall it be liable for incidental or consequential damages resulting from the use of information contained in this manual.

INDUSTRIAL CONTROL COMMUNICATIONS, INC.'S PRODUCTS ARE NOT AUTHORIZED FOR USE AS CRITICAL COMPONENTS IN LIFE-SUPPORT DEVICES OR SYSTEMS. Life-support devices or systems are devices or systems intended to sustain life, and whose failure to perform, when properly used in accordance with instructions for use provided in the labeling and user's manual, can be reasonably expected to result in significant injury.

No complex software or hardware system is perfect. Bugs may always be present in a system of any size. In order to prevent danger to life or property, it is the responsibility of the system designer to incorporate redundant protective mechanisms appropriate to the risk involved.

This user's manual may not cover all of the variations of interface applications, nor may it provide information on every possible contingency concerning installation, programming, operation, or maintenance.

The contents of this user's manual shall not become a part of or modify any prior agreement, commitment, or relationship between the customer and Industrial Control Communications, Inc. The sales contract contains the entire obligation of Industrial Control Communications, Inc. The warranty contained in the contract between the parties is the sole warranty of Industrial Control Communications, Inc., and any statements contained herein do not create new warranties or modify the existing warranty.

Any electrical or mechanical modifications to this equipment without prior written consent of Industrial Control Communications, Inc. will void all warranties and may void any UL/cUL listing or other safety certifications. Unauthorized modifications may also result in equipment damage or personal injury.

Usage Precautions

Operating Environment

- Please use the interface only when the ambient temperature of the environment into which the unit is installed is within the following specified temperature limits:
Operation: -10 ~ +60°C (+14 ~ +140°F)
Storage: -40 ~ +85°C (-40 ~ +185°F)
- Avoid installation locations that may be subjected to large shocks or vibrations.
- Avoid installation locations that may be subjected to rapid changes in temperature or humidity.

Installation and Wiring

- Proper ground connections are vital for both safety and signal reliability reasons. Ensure that all electrical equipment is properly grounded.
- Route all communication cables separate from high-voltage or noise-emitting cabling (such as ASD input/output power wiring).

TABLE OF CONTENTS

1. Introduction	5
2. Features	6
3. Gateway Concepts	8
4. Precautions and Specifications	10
4.1 Installation Precautions.....	10
4.2 Maintenance Precautions.....	11
4.3 Inspection.....	11
4.4 Maintenance and Inspection Procedure.....	11
4.5 Storage	12
4.6 Warranty	12
4.7 Disposal	12
4.8 Environmental Specifications	12
5. Gateway Overview	13
5.1 Power Supply Electrical Interface	14
5.2 Ethernet Port.....	14
5.3 Power over Ethernet (PoE)	15
5.4 RS-485 Port Electrical Interface.....	15
6. Installation	17
6.1 Mounting the Gateway	17
6.1.1 <i>Panel / Wall Mounting</i>	17
6.1.2 <i>DIN Rail Mounting</i>	18
6.2 Wiring Connections.....	19
6.3 Grounding.....	19
7. LED Indicators	20
7.1 Module/Network Status	20
7.2 RS-485 Network Status	21
7.3 Ethernet Status	21
8. Configuration Concepts	22
8.1 ICC Configuration Studio	22
8.2 General Object Editing Activities.....	25
8.2.1 <i>Device Settings</i>	26
8.2.2 <i>USB Virtual COM Port Settings</i>	27
8.2.3 <i>USB Serial Capture Window</i>	28
8.2.4 <i>Batch Update Mode</i>	30
8.3 Ethernet Settings	31
8.3.1 <i>Authentication</i>	31

8.3.2	<i>Network Configuration</i>	32
8.4	Internal Logic Settings	32
8.4.1	<i>Alarms</i>	32
8.4.2	<i>Fail-safe Values</i>	34
8.4.3	<i>Database Logic</i>	35
8.5	Service Objects and Diagnostics Objects	39
9.	Interacting With the Filesystem	41
9.1	Using FTP with Windows Explorer.....	42
9.2	Using FTP with a Windows Command Prompt	43
9.3	Using FTP with Core FTP LE.....	46
10.	Embedded Web Server	48
10.1	Overview	48
10.2	Authentication	49
10.3	Activity Panel	49
10.4	Navigation Menu Tree.....	50
10.5	Monitor Menu	51
10.5.1	<i>Activity Indicator</i>	51
10.5.2	<i>Database</i>	51
10.6	INCON Client Menu	52
10.7	BBMD Server Menu	53
10.7.1	<i>BBMD Status</i>	53
10.7.2	<i>Broadcast Distribution Table (BDT)</i>	53
10.7.3	<i>Foreign Device Table (FDT)</i>	54
10.8	Dashboard Menu	55
10.8.1	<i>Gauge Panel Navigation</i>	55
10.8.2	<i>Gauge Panel Configuration</i>	56
10.8.3	<i>Activity Indicator</i>	59
10.8.4	<i>Submitting Changes</i>	59
11.	RS-485 Drivers	60
12.	Ethernet Drivers	61
13.	Troubleshooting	62
14.	Appendix A: Database Endianness	64
14.1	Modbus - PROFIBUS Example.....	66
14.2	Modbus - DeviceNet Example.....	67
14.3	BACnet - DeviceNet Example.....	68
14.4	BACnet - Modbus Analog Element Example.....	70
14.5	BACnet - Modbus Binary Element Example.....	71
15.	Appendix B: Diagnostics Objects	73
16.	Appendix C: BACnet PICS	75

1. Introduction

Congratulations on your purchase of the ICC ETH-1000 Multiprotocol Ethernet Communications Gateway. This gateway allows information to be transferred seamlessly between various industrial Ethernet networks and one of several RS-485-based networks. In addition to the supported fieldbus protocols, the gateway hosts a USB interface for configuring the gateway via a PC.

Before using the gateway, please familiarize yourself with the product and be sure to thoroughly read the instructions and precautions contained in this manual. In addition, please make sure that this instruction manual is delivered to the end user of the gateway, and keep this instruction manual in a safe place for future reference or unit inspection.

For the latest information, support software and firmware releases, please visit <http://www.iccdesigns.com>.

Before continuing, please take a moment to ensure that you have received all materials shipped with your kit. These items are:

- ETH-1000 Gateway in plastic housing
- Documentation CD-ROM
- DIN rail adapter with two pre-mounted screws
- Four black rubber feet
- USB cable

Note that different gateway firmware versions may provide varying levels of support for the various protocols. For optimal performance, always ensure that you are using the latest version of the ICC Configuration Studio and included firmware.

This manual will primarily be concerned with the gateway's hardware specifications, installation, wiring, configuration and operational characteristics.

To maximize the abilities of your new gateway, a working familiarity with this manual will be required. This manual has been prepared for the gateway installer, user, and maintenance personnel. With this in mind, use this manual to develop a system familiarity before attempting to install or operate the gateway.

2. Features

Supported Protocols

The gateway provides support for a variety of Ethernet and RS-485 based fieldbus protocols. Refer to section 11 and section 12 for detailed information on each specific supported driver.

Supported Baud Rates

The gateway supports the following baud rates on the RS-485 port:

- 300
- 600
- 1200
- 2400
- 4800
- 9600
- 19200
- 38400
- 57600
- 76800
- 115200

Note that not all protocols support every baud rate listed above. Refer to section 11 for more information.

Field-Upgradeable

As new firmware becomes available, the gateway can be upgraded in the field by the end-user. Refer to section 8.1 for more information.

USB Interface

The gateway can be connected to a PC via a USB mini type-B cable. This simultaneously supplies power while providing the ability to configure the gateway, monitor data, and update firmware on the device using the ICC Configuration Studio. Refer to section 8.1 for more information.

USB Virtual COM Port Interface

The gateway can be configured to enumerate as a USB virtual COM port, allowing a PC to directly communicate to the gateway using any supported serial protocol, tunnel through the gateway to communicate on the connected RS-485 bus, or capture network traffic on the RS-485 port without impacting communications. Refer to section 8.2.2 for more information.

Power over Ethernet (PoE) Enabled

The gateway can be externally powered according to the PoE specification (IEEE 802.3af). Refer to section 5.2 for more information.

Alarm Evaluation with Email Notification

The gateway can autonomously monitor any database address and send emails to up to four recipients when a certain condition is detected. Alarm conditions have both value and time constraints, and can be configured to retrigger at a fixed interval as long as the alarm condition continues to be satisfied. Twenty individually-configurable alarms are available. Refer to section 8.4.1 for more information.

Embedded Web Server

The gateway supports real-time web browser-based interaction via an Adobe® Flash Player plug-in. This includes support for configuration, database interaction, and a dashboard GUI with multiple panels, each of which can be configured to display data in a variety of meter/graph/gauge formats. Refer to section 10 for more information.

User-Configurable Network Timeouts

The gateway can be configured to perform a specific set of actions when network communications are lost. This allows each address in the database to have its own unique “fail-safe” condition in the event of network interruption (support for this feature varies depending on the protocol). Refer to section 8.4.2 for more information.

PLC-Style Database Manipulation Operations

A variety of database logic operations are included which provide PLC-style manipulation of database values. Categories such as logical, arithmetic and filtering operations allow for autonomous control over value modification and data movement within the database. High-level signal conditioning is also realizable via the construction of compound formulas derived from the elemental building block operations provided. Refer to section 8.4.3 for more information.

Flexible Mounting Capabilities

The gateway includes all hardware for desktop, panel/wall and DIN-rail mounting capabilities. Refer to section 6.1 for more information.

3. Gateway Concepts

The ETH-1000 is a member of the Millennium Series communication gateways. Members of this family are designed to provide a uniform interface, configuration and application experience. This commonality reduces the user's learning curve, reducing commissioning time while simplifying support. All Millennium Series gateways are configured using the ICC Configuration Studio. The ETH-1000 provides simultaneous support for many different communication protocols, allowing complex interchanges of data between otherwise incompatible networks.

The heart of the Millennium Series concept is its internal database. The database is a 4 KB, byte-wise addressable data array. This provides a total size of 4096 bytes for the entire database, referred to as DB_{Size} in the protocol driver manuals. The database allows data to be routed from any supported network to any other supported network. Data may be stored into the database in either big-endian style (meaning that if a 16-bit or 32-bit value is stored in the database, the most significant byte will start at the lowest address) or little-endian style (meaning that if a 16-bit or 32-bit value is stored in the database, the least significant byte will start at the lowest address).

The other fundamental aspect of the Millennium Series is the concept of a configurable "service object". A service object is used for any master/client protocol to describe what service (read or write) is to be requested on the network. The gateway will cycle through the defined service objects in a round-robin fashion; however, the gateway does implement a "write first" approach. This means that the gateway will perform any outstanding write services before resuming its round-robin, read request cycle.

Additionally, the database and service objects provide the added benefit of "data mirroring", whereby current copies of data values (populated by a service object) are maintained locally within the gateway itself. This greatly reduces the request-to-response latency times on the various networks, as requests (read or write) can be entirely serviced locally, thereby eliminating the time required to execute a secondary transaction on a different network.

In order to facilitate the free scaling and conversion of native data values, a user-configurable "multiplier" and "data type" exist for some network configurations. All network values are scaled by a multiplier prior to being stored into the database or after being retrieved from the database. The data type is used to determine how many bytes are allocated for the value in the database, whether the value should be treated as signed or unsigned, and whether the value should be interpreted as an integer or a floating point number upon retrieval from the database.

A typical use of the multiplier feature is to preserve the fractional components of a network value for insertion into the database. For example, if the floating-point value "3.19" is read by the gateway from a remote BACnet device, then we could use a multiplier value of 0.01 to preserve all of the significant digits of this value: the network representation (3.19) will be divided by the multiplier value (0.01) to

obtain a resultant value of 319, which will then be inserted into the database. Similarly, when a value in the database corresponding to a specific service object is changed (which therefore requires that this updated value be written to the associated remote device on the network), the service object's multiplier value will first be multiplied by the database value in order to obtain the resultant network value. For example, if 3000 is written to the database at a location corresponding to a certain service object on the other port, and that service object's multiplier value is 0.1, then the database value (3000) will be multiplied by the multiplier value (0.1) to obtain the resultant network value of 300.0, which will then be written to the network as a native floating point value.

An appropriate data type should be selected based on the range of the network data values. For example, if the value of an Analog Output on a remote BACnet device can vary from -500 to 500, a 16-bit signed data type should be used. If the value can only vary from 0 to 150, for example, an 8-bit unsigned data type may be used. Care must be taken so that a signed data type is selected if network data values can be negative. For example, if 0xFF is written to the database at a location corresponding to a service object with an 8-bit unsigned data type, the resultant network value will be 255₁₀ (assuming a multiplier of 1). However, if 0xFF is written to the database at a location corresponding to a service object with an 8-bit signed data type, the resultant network value will be -1₁₀ (again, assuming a multiplier of 1). It is also important to select a data type large enough to represent the network data values. For example, if a value of 257 is read by the gateway from a remote device and the data type corresponding to that service object is 8-bit unsigned, the value that actually will be stored is 1 (assuming a multiplier of 1). This is because the maximum value that can be stored in 8-bits is 255. Any value higher than this therefore results in overflow.

The Millennium Series gateways also provide a powerful data-monitoring feature that allows the user to view and edit the database in real time, as well as view the status of service objects via the *ICC Configuration Studio's* Database panel when connected via USB to a PC. The ability to interact with the database is also available via the embedded web server.

When properly configured, the gateway will become essentially "transparent" on the networks, and the various network devices can engage in seamless dialogs with each other.

4. Precautions and Specifications



Rotating shafts and electrical equipment can be hazardous. Installation, operation, and maintenance of the gateway shall be performed by **Qualified Personnel** only.

Qualified Personnel shall be:

- Familiar with the construction and function of the gateway, the equipment being driven, and the hazards involved.
- Trained and authorized to safely clear faults, ground and tag circuits, energize and de-energize circuits in accordance with established safety practices.
- Trained in the proper care and use of protective equipment in accordance with established safety practices.

Installation of the gateway should conform to all applicable **National Electrical Code (NEC) Requirements For Electrical Installations**, all regulations of the **Occupational Safety and Health Administration**, and any other applicable national, regional, or industry codes and standards.

DO NOT install, operate, perform maintenance, or dispose of this equipment until you have read and understood all of the following product warnings and user directions. Failure to do so may result in equipment damage, operator injury, or death.

4.1 Installation Precautions



- Avoid installation in areas where vibration, heat, humidity, dust, metal particles, or high levels of electrical noise (EMI) are present.
- Do not install the gateway where it may be exposed to flammable chemicals or gasses, water, solvents, or other fluids.
- Where applicable, always ground the gateway to prevent electrical shock to personnel and to help reduce electrical noise.

Note: *Conduit is not an acceptable ground.*

- Follow all warnings and precautions and do not exceed equipment ratings.

4.2 Maintenance Precautions



- **Do Not** attempt to disassemble, modify, or repair the gateway. Contact your ICC sales representative for repair or service information.
- If the gateway should emit smoke or an unusual odor or sound, turn the power off immediately.
- The system should be inspected periodically for damaged or improperly functioning parts, cleanliness, and to determine that all connectors are tightened securely.

4.3 Inspection

Upon receipt, perform the following checks:

- Inspect the unit for shipping damage.
- Check for loose, broken, damaged or missing parts.

Report any discrepancies to your ICC sales representative.

4.4 Maintenance and Inspection Procedure

Preventive maintenance and inspection is required to maintain the gateway in its optimal condition, and to ensure a long operational lifetime. Depending on usage and operating conditions, perform a periodic inspection once every three to six months.

Inspection Points

- Check that there are no defects in any attached wire terminal crimp points. Visually check that the crimp points are not scarred by overheating.
- Visually check all wiring and cables for damage. Replace as necessary.
- Clean off any accumulated dust and dirt.
- If use of the interface is discontinued for extended periods of time, apply power at least once every two years and confirm that the unit still functions properly.
- Do not perform hi-pot tests on the interface, as they may damage the unit.

Please pay close attention to all periodic inspection points and maintain a good operating environment.

4.5 Storage

- Store the device in a well-ventilated location (in its shipping carton, if possible).
- Avoid storage locations with extreme temperatures, high humidity, dust, or metal particles.

4.6 Warranty

This gateway is covered under warranty by ICC, Inc. for a period of 12 months from the date of installation, but not to exceed 18 months from the date of shipment from the factory. For further warranty or service information, please contact Industrial Control Communications, Inc. or your local distributor.

4.7 Disposal

- Contact the local or state environmental agency in your area for details on the proper disposal of electrical components and packaging.
- Do not dispose of the unit via incineration.

4.8 Environmental Specifications

Item	Specification
Operating Environment	Indoors, less than 1000m above sea level, do not expose to direct sunlight or corrosive / explosive gasses
Operating Temperature	-10 ~ +60°C (+14 ~ +140°F)
Storage Temperature	-40 ~ +85°C (-40 ~ +185°F)
Relative Humidity	20% ~ 90% (without condensation)
Vibration	5.9m/s ² (0.6G) or less (10 ~ 55Hz)
Grounding	Non-isolated, referenced to power ground
Cooling Method	Self-cooled



This device is lead-free / RoHS-compliant.

5. Gateway Overview

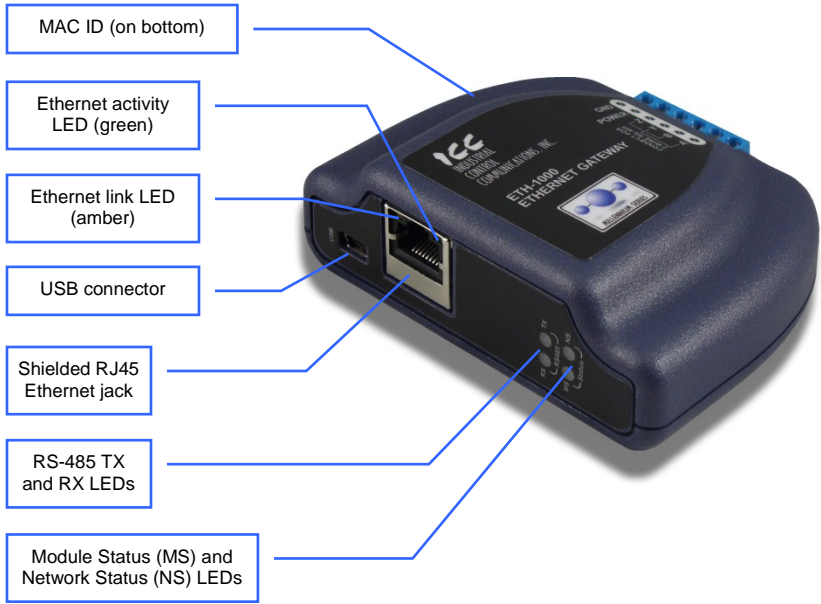

Gateway Overview (Front)



Gateway Overview (Back)

5.1 Power Supply Electrical Interface

When the gateway is not plugged into a PC via the USB cable, it must be powered by an external power source or via Power over Ethernet (PoE: refer to section 5.2). When using an external power source connected to the gateway's power and ground terminals, ensure that the power supply adheres to the following specifications:

Voltage rating 7 - 24VDC
Minimum Current rating 150mA (@24VDC)

- ICC offers an optional 120VAC/12VDC power supply (ICC part number 10755) that can be used to power the gateway from a standard wall outlet.
- The power supply must be connected to the gateway's terminal block at terminals TB:5 (POWER) and TB:6 (GND) as highlighted in Figure 1.



Figure 1: Terminal Block Power Supply Connections

5.2 Ethernet Port

The gateway supports an IEEE 802.3 10BASE-T/100BASE-TX Ethernet port. The Ethernet port accepts standard CAT5-type 8-conductor unshielded twisted-pair (UTP) patch cables. The single Ethernet port supports multiple simultaneous protocols. The port is set for auto-negotiation to automatically select the network speed and duplex.

5.3 Power over Ethernet (PoE)

The gateway supports the IEEE 802.3af Power over Ethernet (PoE) standard as a mode A or mode B powered device (PD). In mode A, the Ethernet jack pins 1-2 (pair #2 in T568B wiring) form one side of the DC supply and pins 3-6 (pair #3 in T568B) form the other side. These are the same two pairs used for data transmission in 10Base-T and 100Base-TX, allowing the provision of both power and data over only two pairs in such networks.

In mode B, the Ethernet jack pins 4-5 (pair #1 in both T568A and T568B cabling standards) form one side of the DC supply and pins 7-8 (pair #4 in both T568A and T568B) provide the return; these are the "spare" pairs in 10BASE-T and 100BASE-TX. Mode B power transmission, therefore, requires the use of a full 4-pair Ethernet cable.

The gateway enumerates itself as a power level class 0 device (12.95W max. indicated consumption). The use of PoE endspan ("PoE switch") or midspan ("power injector") power sourcing equipment (PSE) provides for the ability to power the gateway without the necessity of connecting a dedicated power supply to the power supply terminal block.

5.4 RS-485 Port Electrical Interface

In order to ensure appropriate network conditions (signal voltage levels, etc.) when using the gateway's RS-485 port, some knowledge of the network interface circuitry is required. Refer to Figure 2 for a simplified network schematic of the gateway's internal RS-485 interface circuitry. The port has 4 terminals for four-wire communication. For two-wire communication, connect a jumper wire between TB:1 (A / RXD+) and TB:3 (Y / TXD+) and a wire between TB:2 (B / RXD-) and TB:4 (Z / TXD-).

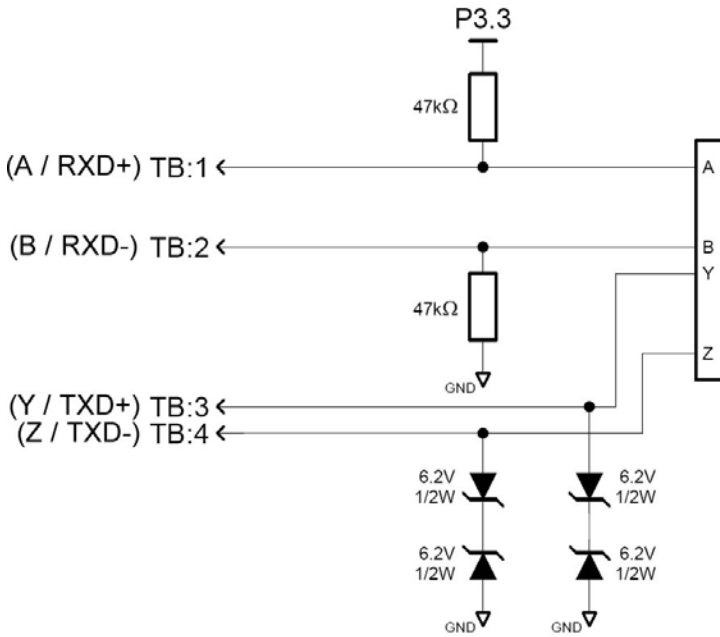

Figure 2: RS-485 Interface Circuitry Schematic

Figure 3 highlights the terminals on the gateway's terminal block that are specific to RS-485 connections.



Figure 3: Terminal Block RS-485 Connections

6. Installation

The gateway's installation procedure will vary slightly depending on the mounting method used. Before mounting the gateway, install the 4 black rubber feet (Figure 4) onto the bottom of the enclosure.



Figure 4: Rubber Feet

6.1 Mounting the Gateway

The gateway may be mounted on a panel, a wall or a DIN rail. In all cases, the gateway is mounted using the two keyhole-shaped screw holes on the bottom of the enclosure. A DIN rail adapter with two pre-mounted screws is provided for mounting the gateway on a DIN rail. The user must choose the appropriate hardware for mounting the gateway on a panel or wall. When choosing screws for panel or wall mounting, ensure the head size matches the keyhole screw holes on the back of the enclosure. The following describes the method for the two mounting options.

6.1.1 Panel / Wall Mounting

To mount the gateway on a panel or wall, drill two holes 25mm apart vertically. Screw two screws into the holes and mount the gateway on the screws.

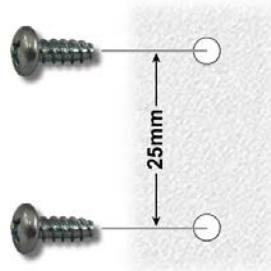

Figure 5: Panel / Wall Mounting Diagram

6.1.2 DIN Rail Mounting

The DIN rail adapter (Figure 6) can clip onto 35mm and G-type rails. To mount the gateway to a DIN rail, clip the DIN rail adapter onto the DIN rail and mount the gateway on the screws (the screws should already be seated into the adapter at the proper height). Refer to Figure 7, Figure 8, and Figure 9.



Figure 6: DIN Rail Adapter

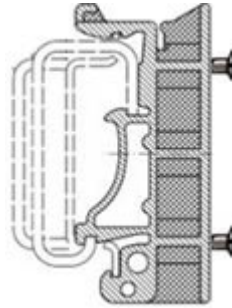

Figure 7: DIN Rail Adapter Attachment



Figure 8: Unit with Attached
DIN Rail Adapter



Figure 9: Example Installation

6.2 Wiring Connections

Note that in order to power the unit, a power supply must also be installed. Refer to sections 5.1 and 5.2 for more information.

1. Mount the unit via the desired method (refer to section 6.1).
2. Connect the various networks to their respective plugs/terminal blocks. Ensure that any wires are fully seated into their respective terminal blocks, and route the network cables such that they are located well away from any electrical noise sources, such as adjustable-speed drive input power or motor wiring. Also take care to route all cables away from any sharp edges or positions where they may be pinched.
3. Take a moment to verify that the gateway and all network cables have sufficient clearance from electrical noise sources such as drives, motors, or power-carrying electrical wiring.
4. If not using PoE, connect an external power supply to the gateway's RS-485 terminal block on the terminals labeled POWER and GND. Pay particular attention to the proper polarity.

6.3 Grounding

Grounding is of particular importance for reliable, stable operation. Communication system characteristics may vary from system to system, depending on the system environment and grounding method used.

The gateway has one logic ground located on the RS-485 terminal block, which serves as the ground reference for both power and RS-485 communication signals.

CAUTION:

Note that there is a single chassis ground terminal adjacent to the RS-485 terminal block. This chassis ground terminal is NOT internally connected to the "GND" terminal on the RS-485 terminal block. Do not make any logic grounding connections to the chassis ground terminal.

Please be sure to consider the following general points for making proper ground connections:

Grounding method checkpoints

1. Make all ground connections such that no ground current flows through the case or heatsink of a connected electrical device.
2. Do not connect the gateway's GND terminal to a power ground or any other potential noise-producing ground connection (such as an adjustable-speed drive's "E" terminal).
3. Do not make connections to unstable grounds (paint-coated screw heads, grounds that are subjected to inductive noise, etc.)

7. LED Indicators

The gateway contains several different LED indicators, each of which conveys important information about the status of the unit and connected networks. These LEDs and their functions are summarized here.

7.1 Module/Network Status

The gateway has two dichromatic, stacked LEDs to indicate the status of the module (MS) and the status of the network driver (NS). On startup, the LEDs blink a startup sequence: green-red-green-red. Always confirm this sequence upon powering the gateway to ensure the device is functioning properly. Refer to Table 1 and Table 2 for further details.

Table 1: Module Status LED

LED State	Indication
Off	No power
Green	Gateway has power and is functioning normally
Flashing Green	The gateway has established a USB connection
Flashing Red	A fatal error has occurred. The number of sequential blinks (followed by 2 seconds of OFF time) indicates the error code.
Alternating Red/Green	Startup sequence

Table 2: Network Status LED

LED State	Indication
Off	No power / no IP address / no PROFINET IO connection
Green	Gateway has an IP address and one or more EtherNet/IP or PROFINET IO server connections have been established with a client
Flashing Green	Gateway has an IP address but no EtherNet/IP connections have been established with a client
Red	Critical link failure / duplicate IP address
Flashing Red	One or more EtherNet/IP connections timed-out
Alternating Red/Green	Startup sequence

7.2 RS-485 Network Status

The gateway has one red and one green LED to indicate the status of the RS-485 network.

Green (TX) LED Lights when the gateway is transmitting data on the RS-485 port.

Red (RX) LED Lights when the gateway is receiving data on the RS-485 port. Note that this does not indicate the validity of the data with respect to a particular protocol: only that data exists and is being detected. Also note that if a 2-wire RS-485 network is in use, that the gateway's RX LED will light in conjunction with the TX LED (as transmitting devices on 2-wire RS-485 networks also receive their own transmissions).

7.3 Ethernet Status

The Ethernet jack contains two embedded LEDs which indicate the status of the Ethernet physical layer

Amber LED Ethernet link: lit whenever a viable Ethernet network is connected to the port. The LED must be lit for any Ethernet communication to occur.

Green LED Ethernet Activity: blinks briefly when Ethernet packets are sent or received. The LED may appear solid green if there is a large amount of network traffic.

8. Configuration Concepts

8.1 ICC Configuration Studio

The gateway can be configured by a PC via a USB mini type-B cable. This connection provides power to the device, so there is no need for any external power supply while the gateway is attached to the PC.

The gateway is configured by the *ICC Configuration Studio* PC application, and this section will provide only a brief introduction to the configuration concepts. For more detailed information on how to install and use the Configuration Studio, refer to the separately-available training resources.

Creating a Device Configuration

A device can be added to the **Project** panel for configuration by first selecting the **Device Configurations** list heading and then:

- Double-clicking on it in the **Available Devices** panel.
- Right-clicking on it in the **Available Devices** panel and choosing **Add** from the context-sensitive menu.
- Hitting the <ENTER> key on the keyboard when the device is selected in the **Available Devices** panel.
- Dragging it from the **Available Devices** panel into the **Project** panel.
- Selecting it and selecting **Add Selected Device** from the **Edit** menu.
- Selecting it and clicking the **Add** button in the toolbar.

The device will then be added to the list of **Device Configurations**.

Going Online with a Device

All connected devices are automatically added to the **Discovered Devices** panel. This panel is shown by selecting the **Online Devices** list heading in the **Project** panel. To go online with a device:

- Double-click on it in the **Discovered Devices** panel.
- Right-click on it in the **Discovered Devices** panel and choose **Go Online** from the context-sensitive menu.
- Hit the <ENTER> key on the keyboard when the device is selected in the **Discovered Devices** panel.
- Drag it from the **Discovered Devices** panel into the **Project** panel.
- Select it and select **Go Online with Device** from the **Edit** menu.
- Select it and click the **Go Online** button in the toolbar.

When the studio goes online with a device, its configuration is automatically read. While the studio is online with a device, it will appear in green text in the **Discovered Devices** panel. The studio may be online with multiple devices simultaneously.

Uploading a Device's Configuration into a Project

The current configuration of an online device can be uploaded into the **Project** panel by selecting a device under the **Online Devices** list heading and then:

- Right-clicking on it and choosing **Upload Configuration** from the context-sensitive menu.
- Dragging it from the **Online Devices** heading into the **Device Configurations** heading.
- Selecting it and selecting **Upload Configuration to Project** from the **Device** menu.
- Selecting it and clicking the **Upload Configuration** button in the toolbar.

The device's configuration will then be added to the list of **Device Configurations**. Once the configuration is uploaded into the project, it may be modified.

Removing a Device Configuration from a Project

A configuration can be removed from a project by:

- Selecting the device in the **Project** panel and dragging it. A trash can icon will appear at the bottom of the **Project** panel, and dragging and dropping the device in the trash will remove it from the project.
- Hitting the <DELETE> key on the keyboard when the device is selected in the **Project** panel.
- Right-clicking on the device in the **Project** panel and choosing **Remove** from the context-sensitive menu.
- Selecting **Remove Selected Item** from the **Edit** menu when the device is selected.
- Clicking on the **Remove** button in the toolbar when the device is selected.

Going Offline with a Device

To go offline with a device:

- Select the device in the **Project** panel and drag it. A trash can icon will appear at the bottom of the **Project** panel, and dragging and dropping the device in the trash will go offline with it.
- Hit the <DELETE> key on the keyboard when the device is selected in the **Project** panel.
- Right-click on the device in the **Project** panel and choose **Go Offline** from the context-sensitive menu.
- Select **Go Offline with Device** from the **Edit** menu when the device is selected.
- Click on the **Go Offline** button in the toolbar when the device is selected.

Importing a Configuration from a Project File

An existing project file can be imported into the currently-active project. Click **File...Import Project**, and then select the desired *.icsproj file. The contents of the imported file will be merged with the active project.

Downloading a Configuration to a Device

To download a configuration to an online device, first select the device under the **Device Configurations** heading in the **Project** panel, and then navigate to **Device...Download Configuration to Device**. If the studio is currently online with only one compatible device, then the configuration will be downloaded to the online device. Otherwise, a device selection prompt is displayed to select which device to download the configuration to.

Updating Firmware

The studio automatically manages firmware updates when going online with a device and downloading a configuration to a device. Do not power off the device once the update is in progress as this may corrupt the firmware and/or the configuration.

Resetting an Online Device

To reset an online device, first select the device in the **Project** panel and then navigate to **Device...Reset Device**.

Interacting with the Database

To interact with a device's database, select the device in the **Project** panel and then select the **Database** panel. If the **Database** panel is not visible, it can be enabled via **View...Database**. When an online device is selected, data values are updated from the device in real-time, and values can be edited by double-clicking the desired location in the database.

Diagnostics

To monitor the status of service objects, select the device in the **Project** panel and then select the **Diagnostics** panel. If the **Diagnostics** panel is not visible, it can be enabled via **View...Diagnostics**. When an online device is selected, diagnostics information is updated from the device in real-time. Individual diagnostics entries can be selected by clicking on them in the list, and multiple entries can be selected by either <CTRL>+clicking on them (to select them individually) or <SHIFT>+clicking on them (to select a range of entries). Counter values of all currently-selected diagnostics entries can be reset by clicking the **Reset Selected Counters** button.

General Configuration Process

To configure a device, add the desired protocols for the various ports, configure the communication settings (baud rate, parity, address, timeout, and scan rate/response delay etc.), and configure any objects associated with the respective protocols. Any changes will take effect once the configuration is downloaded to a device.

Note that numeric values can be entered not only in decimal but also in hexadecimal by including "0x" before the hexadecimal number.

8.2 General Object Editing Activities

The following editing activities apply for all types of configuration objects and project elements.

Adding an Object

To add an object, click on an item (protocol driver or Node, for example) in the **Project** panel. Any available objects for that item will be listed in the **Available Objects** panel (the panel title depends on the currently-selected item). An object can then be added to the item by:

- Double-clicking on it.
- Right-clicking on it and choosing **Add** from the context-sensitive menu.
- Hitting the <ENTER> key on the keyboard when the object is selected.
- Dragging it into the **Project** panel.
- Selecting it and selecting **Add Selected Device** from the **Edit** menu.
- Selecting it and clicking the **Add** button in the toolbar.

The object's configurable fields can then be populated with valid values (where applicable).

Viewing an Object

In the **Project** panel, select a parent object to display a summary of all its child objects. For example, selecting a protocol driver will display the driver's configuration in the **Summary** panel and list of current objects in the **Object List** panel.

Updating an Object

To update an object, select the object in the **Project** panel and make any required changes in the **Settings** panel.

Deleting an Object

An object can be deleted by performing one of the following actions:

- Selecting the object in the **Project** panel and dragging it. A trash can icon will appear at the bottom of the **Project** panel, and dragging the object to the trash will then delete it from the project.
- Hitting the <DELETE> key on the keyboard when the object is selected in the **Project** panel.
- Right-clicking on the object in the **Project** panel and choosing **Remove** from the context-sensitive menu.
- Selecting **Remove Selected Item** from the **Edit** menu when the object is selected.
- Clicking on the **Remove** button in the toolbar when the object is selected.

Note that this action cannot be undone. Deleting an object will also delete all of its child objects.

Copying and Pasting an Object

To copy an object, first click on an item in the **Project** panel. An object can then be copied by:

- Right-clicking on it and choosing **Copy** from the context-sensitive menu.
- Pressing the <CTRL+C> keys on the keyboard.
- Holding the <CTRL> key and dragging the item to the desired location in the **Project** panel.
- Dragging the item to a new location under a different parent object in the **Project** panel.
- Selecting **Copy Selected Item** from the **Edit** menu.
- Clicking on the **Copy** button in the toolbar.

To paste an object, first click on an item at the desired location in the **Project** panel. An object can then be pasted by:

- Right-clicking on it and choosing **Paste** from the context-sensitive menu.
- Pressing the <CTRL+V> keys on the keyboard.
- Dropping an item onto the desired location in the **Project** panel after holding the <CTRL> key and dragging the item.
- Dropping an item onto a new location under a different parent object in the **Project** panel after dragging the item.
- Selecting **Paste Item** from the **Edit** menu.
- Clicking on the **Paste** button in the toolbar.

After pasting an object, the object's configurable fields can then be modified with valid values (where applicable).

Note that the studio allows you to copy and paste items between different locations, including different devices. This is useful for copying partial configurations from one device to another.

Reordering Objects

Objects can be reordered in the **Project** panel by dragging the item to the desired location. If the item is dragged outside of the items in the project tree, it will be moved to the end.

8.2.1 Device Settings

The following fields can be configured for a device. To view or edit device settings, click on the device in the **Project** panel. The settings are then available in the **Settings** panel.

Device Description

Each device added to a project can be individually tagged with a unique description string of up to 32 characters in length. This allows the devices within a project or an automation system to be clearly identifiable with their location or functional purpose.

Database Endianness Selection

Select the desired endianness for how data will be stored in the device's internal database for multi-byte data types. For more information on database endianness, refer to Appendix A: Database Endianness.

8.2.2 USB Virtual COM Port Settings

The device can be configured to enumerate as a USB virtual COM port, providing direct serial communications between the device and a PC through the USB connection. The COM port can be used for various tasks, depending on the selected mode. This section details the different functions of the virtual COM port.

Mode

Select the desired mode for how the USB virtual COM port will be used. The available options are detailed below.

Serial Pass-Through

Select this option to cause the device to behave as a USB-to-serial converter. Any data sent to the USB virtual COM port will be forwarded to the physical serial port and any data received by the physical serial port will be forwarded to the USB virtual COM port. Note that while the device is in this mode all other functionality of the device is disabled, regardless of other configuration settings.

Serial Redirect

Select this option to redirect communications from the selected serial port on the device to the USB virtual COM port. By selecting this option, the device will communicate with the PC over the virtual COM port using the settings configured on the associated serial port. This allows the device to communicate with the PC using any of the supported serial port protocols. Note that the physical serial port is disabled when the device is configured in this mode.

Serial Sniffer

Select this option to sniff the received and transmitted packets on the selected serial port and output the data to the virtual COM port. When this mode is selected, the device will attempt to output every packet that the protocol driver configured on the serial port receives and transmits.

Because the sniffer operates independently from the physical serial port (so as not to impact communications), there may be times when the sniffer cannot output a received or transmitted packet due to the USB connection being unable to process characters faster than they are exchanged on the physical serial port. When this occurs, the sniffer will output the characters "ERR: Sniffer Packet Overflow" or "ERR: Sniffer Buffer Overflow". Additionally, the sniffer is able to detect receive errors on the serial port such as parity, overrun, and framing errors. If a

receive error occurs on one or more characters of a packet, the sniffer will output the characters “ERR: Receive Error”.

Note that because the serial sniffer mode captures packets at the protocol driver level, a protocol must be configured on the selected serial port to provide data to the USB virtual COM port. For convenience, there is a special “USB Serial Sniffer Settings” protocol selection to configure the serial port for sniffing only.

Serial Port

Select the desired serial port to use with the USB virtual COM port.

Sniffer Output Format

Select the desired output format of the serial sniffer data. The formatted data option outputs the captured data as ASCII text characters and includes annotations for whether the packet was received or transmitted, as well as a relative timestamp of when the packet was received or transmitted. The raw data option outputs the captured data as unmodified, binary characters.

8.2.3 USB Serial Capture Window

The USB Serial Capture Window allows connection to a device's USB Virtual COM port to view and save network packets captured by the device. The device's USB Virtual COM port must be configured for Serial Sniffer mode and the Sniffer Output Format must be set to Formatted Data.

When connected, the capture window will display the device's most recent received and transmitted packets. All packets captured during the duration of the session may be saved once the session has ended, even though they all may not be displayed in the window. The status bar at the bottom of the window tracks the duration of the connection as well as the total number of packets the device has received and transmitted.

To open the USB Serial Capture Window, select **USB Serial Capture Window...** from the **Tools** menu.

Capturing Packets

To begin capturing packets, the device must first be configured with the appropriate USB Virtual COM port settings as described above. Once configured, the device will appear in the **COM Port** selection box. Select the desired device from this drop down and connect to the device. To connect to the device, perform one of the following actions:

- Select **Connect** from the **Connection** menu.
- Click on the **Connect** button in the toolbar.

Note that connecting to a device will clear the capture log automatically.

Clearing the Capture Log

All captured data may be cleared at any time while connected to a device or after disconnecting from a device. This will also reset the connection time duration and all counters. To reset all captured data, perform one of the following actions:

- Select **Clear Log** from the **Edit** menu.
- Click on the **Clear Log** button in the toolbar.
- Hit the <DELETE> key on the keyboard.
- Right click on the capture output and select **Clear Log**.

Pausing the Display

While capturing, the output window will display only the most recent packets. Therefore, as new packets are captured and displayed in the window, old packets are removed from the display. At any time during capturing, the display updating may be paused so that no packets are added or removed. To pause the display, perform one of the following actions:

- Select **Pause Display** from the **Display** menu.
- Click on the **Pause Display** button in the toolbar.
- Right click on the capture output and select **Pause Display**.

Note that even though the display does not update when paused, packets are still being captured in the background.

Ending a Capture Session

The capture session is ended by disconnecting from the selected device. To disconnect from the device, perform one of the following actions:

- Select **Disconnect** from the **Connection** menu.
- Click on the **Disconnect** button in the toolbar.

Saving the Captured Data

Once a capture session has ended, the entire captured data may be saved. The data can be saved either as a Wireshark capture file or as a plain text document.

Wireshark Capture File

The captured data can be saved as a file which can be opened, decoded, and analyzed by Wireshark. Wireshark is a free network protocol analyzer and is available at <http://www.wireshark.org/>.

Any protocol capture may be viewed with Wireshark. However, Wireshark currently only supports decoding BACnet MS/TP packets and has limited support for Modbus RTU.

To save the captured data as a Wireshark capture file, perform one of the following actions:

- Select **Save As Wireshark Capture...** from the **File** menu.
- Click on the **Save As Wireshark Capture...** button in the toolbar.

- Hit the <CTRL+S> keys on the keyboard.

Text Document

The captured data can also be saved as a plain text document. To save the captured data as a text document, perform one of the following actions:

- Select **Save As Text...** from the **File** menu.
- Click on the **Save As Text...** button in the toolbar.
- Hit the <CTRL+SHIFT+S> keys on the keyboard.

8.2.4 Batch Update Mode

The ICC Configuration Studio supports a batch update mode for quickly updating firmware, and optionally, the configuration on all discovered devices without user interaction. While in batch update mode, the studio will automatically go online with a device, update the firmware, update the configuration if a matching configuration is found in the project, and then go offline with the device. It will do this for all discovered devices while in this mode. For each discovered device, the studio creates a log entry in the batch update log detailing the actions performed on the device.

Entering Batch Update Mode from within the Studio

To start batch update mode when the studio is open, select **Start Batch Update Mode** from the **Tools** menu. After the studio has entered batch update mode, pressing the ESC key will exit batch update mode. If any devices were discovered while in batch update mode, the studio will display a prompt to view the batch update log.

Launching the Studio in Batch Update Mode

The batch update mode can also be started when the studio is launched by using the “-b” or “-B” command line switch, and optionally, specifying a project file path to load. For example, the command line options “-b MyProject.icsproj” will load the project titled “MyProject” and start batch update mode. When batch update mode is entered using this method, the user cannot exit batch update mode using the ESC key.

Note that the command line options can also be used with a custom shortcut by appending them to the executable path in the **Target** field of the shortcut. This would allow a user to double click on the shortcut to launch the studio in batch update mode.

Viewing the Batch Update Log

After the studio has updated a device while in batch update mode, a log is available that can be accessed by selecting **Open Batch Update Log** from the **Help** menu. The log details the actions that the studio performed on discovered devices during the last batch update session.



At the end of the log, the studio records statistics for the batch update session. The statistics include the following information:

Devices Discovered

The total number of devices discovered while in batch update mode.

Successful

The total number of devices that were updated successfully.

Failed

The total number of devices that the studio failed to update.

Not Updated

The total number of devices that were not updated. This can occur if a device is already up to date, or if a device has limited network connectivity and cannot be updated.

Firmware Updated

The total number of firmware updates performed.

Configuration Updated

The total number of configuration updates performed.

Errors

The total number of devices that encountered an error while being updated. Note that this does not necessarily imply that the device failed to update.

8.3 Ethernet Settings

The **Ethernet Settings** panel contains Ethernet-related items that are not specific to any given protocol. These settings must be appropriately configured regardless of any Ethernet control protocols that may be enabled. To access the **Ethernet Settings** panel, select the device in the **Project** panel, and then add **Ethernet** from the **Available Ports** panel. The **Ethernet Settings** panel is then available whenever the **Ethernet** port is selected in the **Project** panel.

8.3.1 Authentication

Be sure to make a note of the new settings whenever authentication credentials are changed, as they must be entered whenever the web page is accessed or an FTP session is initiated.

User Name

The username is case-sensitive and can contain letters (“a...z” and “A...Z”) and numbers (“0...9”). It can be up to 80 characters in length.

Password

The password is case-sensitive and can contain letters (“a...z” and “A...Z”) and numbers (“0...9”). It can be up to 80 characters in length.

8.3.2 Network Configuration

The gateway supports IP address acquisition via both static assignment as well as DHCP. When static IP assignment is selected, the IP Address, Subnet Mask and Default Gateway fields can be configured. Please consult with your network administrator for the proper settings of these fields.

8.4 Internal Logic Settings

8.4.1 Alarms

8.4.1.1 Overview

Alarms provide a configurable mechanism by which the gateway can autonomously monitor any database address and send emails to up to four recipients when a certain condition is detected. The alarm conditions have both value and time constraints, and can be configured to retrigger at a fixed interval as long as the alarm condition continues to be satisfied. Twenty individually-configurable alarms are available. To add alarms to a device, select the device in the **Project** panel, then add **Internal Logic...Alarms**.

8.4.1.2 Alarm SMTP Settings

SMTP Authentication

Some email servers require that clients wishing to send emails first authenticate themselves. If the email server in use requires authentication, then enter the appropriate User Name and Password. If the email server in use does not require authentication, then these entries can be disregarded.

DNS Servers

Enter the dotted-decimal IP addresses of the Primary Address and Secondary Address of the DNS servers which will be used to resolve the configured SMTP server name. The secondary DNS server will be used if the primary server is inaccessible.

Mail Server

Enter the SMTP Server address as a name or as a dotted-decimal IP address, and the SMTP Port (default=25) on which the SMTP server listens for incoming emails.

“From” Address

Enter the “From” Email address that will appear as the sender’s email address in the email headers.

“To” Addresses

Up to four “To” Email recipients can be designated to receive alarm emails. At least one recipient must be entered. Blank entries will not be processed by the gateway.

8.4.1.3 Alarm Individual Settings

The gateway supports twenty independently-configurable alarms. Individual alarms can be added from the **Available Objects** panel when **Alarms** is selected in the **Project** panel.

Email Subject

Enter a string of up to 128 characters in length which will appear in the “subject” line of the alarm email. The body of the alarm email is empty.

Database Address

Enter the database address that this alarm will continuously monitor. If the Data Type is set to anything other than 8-bit, then this address designates the starting database location for the multi-byte element to be evaluated. For multi-byte elements, whether this designated address represents the element’s high byte or low byte depends upon the current database endianness setting.

Data Type

The data type of the value to be evaluated.

Logical Comparison

Choose a comparison operator which will be used to compare the current database value with the reference comparison Value.

Value, Use Bitmask, Bitmask

The reference comparison Value is comprised of three subcomponents: the above-mentioned Data Type field, a Use Bitmask checkbox and its associated Bitmask field, and a Value field. Each time the alarm is evaluated, the current value at the indicated Database Address is first bit-wise “AND”ed with the Bitmask field (if enabled). The resulting derived value is then compared with the Value field by way of the Logical Comparison operator.

Database values that correspond to “analog” process variables (e.g. frequencies, voltages, counters etc.) should typically uncheck the Use Bitmask checkbox to disable bitmask application. For values that correspond to “enumerated” process variables (e.g. status words where each bit of the database value indicates a different item), however, Use Bitmask can be enabled and an appropriate Bitmask can be specified to isolate one or more bits of the data value.

Note that alarms evaluate the designated database location regardless of the context of the value contained there. What this means is that alarms can react to not only process values that are being read and/or written via the various connected networks, but also to ancillary items such as diagnostics object counters or error indicators.

Minimum Time Condition Must Be True

Alarm analysis processing is performed by the gateway once per second. Enter the number of seconds that the condition must be continuously evaluated as “true” for the alarm to be triggered. A time of 0 seconds means that just a single evaluation of “true” will immediately trigger the alarm.

Periodic Reminder Emails

If the “Send Reminder Emails While Condition Is True” checkbox is unchecked, then only one email transmission will occur when an alarm condition is triggered: further email transmissions will not be attempted for this alarm unless the alarm condition is first evaluated as “false” (which resets the alarm), and then is again triggered by a subsequent event.

If the “Send Reminder Emails While Condition Is True” checkbox is checked, then subsequent email transmissions will be automatically retriggered every “Interval” for a “Maximum Number of Reminder Emails” as long as the alarm condition continues to be evaluated as “true”. If at any time during the subsequent transmission cycle the alarm condition is evaluated as “false”, then the alarm will be reset and email transmissions for this alarm will stop (until the next time the alarm is triggered, of course).

8.4.2 Fail-safe Values

8.4.2.1 Overview

The gateway can be configured to perform a specific set of actions when network communications are lost. This allows each address in the database to have its own unique “fail-safe” condition in the event of network interruption. Support for this feature varies depending on the protocol: refer to the protocol-specific section of this manual for further information.

Note that this timeout feature is only used with slave/server protocols: this is not the same as the Timeout time used for service objects in master/client protocols.

There are two separate elements that comprise the timeout configuration:

- The timeout time
- Timeout Object configuration

8.4.2.2 Timeout Time

The timeout time is the maximum number of milliseconds for a break in network communications before a timeout will be triggered. This timeout setting is configured at the protocol level as part of a driver’s configuration, and used by the protocol drivers themselves to determine abnormal loss-of-communications conditions. These conditions then trigger gateway-wide timeout processing events. If it is not desired to have a certain protocol trigger timeout processing events, then the protocol’s timeout time may be set to 0 (the default value) to disable this feature.

For some protocols, the timeout time is set by the master device (PLC, scanner, etc.), and a timeout time setting is therefore not provided in the Configuration Studio's driver configuration. Additionally, not all protocols support timeout detection: refer to the protocol-specific sections of this manual for more information.

8.4.2.3 Timeout Object Configuration

A timeout object is used by the gateway as part of the timeout processing to set certain addresses of the database to "fail-safe" values. When a timeout event is triggered by a protocol, the timeout objects are parsed and the designated 8-bit, 16-bit, or 32-bit value is written to the corresponding database address(es). To add a timeout object to a device, select the device in the **Project** panel, then add **Internal Logic...Fail-safe Values...Timeout Object**. The following paragraphs describe the configurable fields of a timeout object:

Database Address

Enter the starting address in the database where the first data element of this timeout object will begin. The maximum allowable database address depends on the designated Data Type.

Data Type

The size and range of valid values for each data element in this timeout object. For instance, selecting "16-Bit Unsigned" allows for a range of timeout values between 0 and 65535, each occupying 2 bytes in the database. Similarly, selecting "16-Bit Signed" allows for a range of values between -32768 and 32767, also occupying 2 bytes in the database. Select the desired data type from this dropdown.

Value

Enter the "fail-safe" timeout value that each database address encompassed by this timeout object will be automatically written with upon processing a timeout event triggered by a protocol.

Length

Enter the number of data elements for this timeout object. The total number of database bytes modified by a timeout object is determined by the Length multiplied by the number of bytes in the selected Data Type (1, 2 or 4 for 8-bit, 16-bit and 32-bit, respectively).

8.4.3 Database Logic

8.4.3.1 Overview

A variety of database logic operations are included which provide PLC-style manipulation of database values. Categories such as logical, arithmetic and filtering operations allow for autonomous control over value modification and data movement within the database. High-level signal conditioning is also realizable

via the construction of compound formulas derived from the elemental building block operations provided. To add database logic operations to a device, select the device in the **Project** panel, then add **Internal Logic...Database Logic**.

Database logic operations are executed in sequential order, according to the ordinal position in which the operations are listed in the **Project** panel under the **Database Logic** heading.

Some notes of interest for the database logic operations are as follows:

All Database Logic Operations

- All inputs to an operation may either be a value located in the internal database or a constant value.
- A floating-point “Multiplier” field is available on each database-sourced input and on the output which allows the inputs to be scaled prior to operation execution, and the result to be scaled after operation execution. The input is multiplied by the input multiplier, and the result is divided by the output multiplier.
- All operations can be dynamically enabled/disabled using an optional “Enable Trigger” element (refer to section 8.4.3.3 for more information on Enable Trigger behavior.)
- The outputs of all operations must be stored in the internal database.
- The number of bytes taken from the database (for non-constant inputs) is determined by the corresponding “Data Type” selection, starting at the designated “Database Address”.
- The number of bytes written to the database (for outputs) is determined by the corresponding “Data Type” selection, starting at the designated “Database Address”.

Logical Operations

- *Not*, *And*, *Or*, and *Exclusive Or* operations can be performed on either a bitwise or logical basis, depending on the selection of the “Operation Type”. When a logical operation type is chosen, non-zero input values are considered to be “true” and zero input values are considered to be “false”. The output value of the logical operation will then be written to the database as “1” for true and “0” for false.
- The *Copy* operation outputs the input value.
- The *Bit Copy* operation outputs the value of a single bit from the input database location to a single bit in the output database location. No other bits in the output database location are modified by this operation.
- The *Indirect Copy* operation outputs the value at the database location specified by the input source to the database location specified by the output destination. This operation can be used to access different database locations dynamically. It could also be used to create reusable database logic subroutines by selecting a different input and output location for the subroutine during each execution cycle.
- The *Shift* operation outputs the input value bit-shifted by the shift amount.

- The *Compare* operation outputs a “1” if the comparison evaluates to true, otherwise it outputs a “0”.
- The *Flag Test & Set* operation tests if the bit flags specified in the input mask are set in the input value and sets the bit flags specified in the output mask in the output value. This operation can test for ALL flags set/cleared or ANY flags set/cleared. If the flag test evaluates as true, all bit flags specified in the output mask in the output value are set, otherwise the flags are cleared. Only the bits specified in the output mask in the output value are modified by this operation.
- The *Value Change Detection* operation outputs a “1” if a change is detected in the input value between the last execution cycle and the current execution cycle, otherwise it outputs a “0”.
- The *Multiplexer* operation outputs one of its two inputs, depending on the selection. If *Selection* is zero, *Input 1* is output. If *Selection* is non-zero, *Input 2* is output.
- The *Byte Reverse* operation reverses the byte order of the input value and outputs the result.

Arithmetic Operations

- The *Add* operation calculates the expression $[Input\ 1] + [Input\ 2]$.
- The *Subtract* operation calculates the expression $[Input\ 1] - [Input\ 2]$.
- The *Multiply* operation calculates the expression $[Input\ 1] \times [Input\ 2]$.
- The *Divide* operation calculates the expression $[Input\ 1] / [Input\ 2]$.
- The *Modulo* operation calculates the expression $[Input\ 1] \bmod [Input\ 2]$.
- The *Exponential* operation calculates the expression $[Input\ 1]^{Exponent}$. “Input 1” can be a database value, a constant value, or e (exponential function).
- The *Nth Root* operation calculates the expression $\sqrt[Degree]{Input\ 1}$.
- The *Logarithm* operation calculates the expression $\log_{Base}(Input\ 1)$. “Base” can be a database value, a constant value or e (natural logarithm).
- The *Random* operation outputs a random number between *Input 1* and *Input 2*. Note that the operation is limited to producing only 32,768 unique values.
- The *Divide*, *Exponential*, *Nth Root* and *Logarithm* operations output an integer-rounded value when an integer data type is used.

Trigonometric Operations

- The *Sine* operation calculates the expression $\sin(Input\ 1)$, where *Input1* is in radians.
- The *Cosine* operation calculates the expression $\cos(Input\ 1)$, where *Input1* is in radians.
- The *Tangent* operation calculates the expression $\tan(Input\ 1)$, where *Input1* is in radians.
- The *Arc Sine* operation calculates the expression $\sin^{-1}(Input\ 1)$, where the output is in radians.

- The *Arc Cosine* operation calculates the expression $\cos^{-1}(\text{Input } 1)$, where the output is in radians.
- The *Arc Tangent* operation calculates the expression $\tan^{-1}(\text{Input } 1)$, where the output is in radians.

Filtering Operations

- The *Debounce Filter* and *Hysteresis Filter* operations are functionally identical with the single exception that the *Debounce Filter* does not use a “Value Tolerance” (it is fixed at 0).
- In order for the output of the *Debounce Filter* or *Hysteresis Filter* to change (i.e. reflect the input value), “Input 1” must first change to a value outside of the “Value Tolerance” range and then must remain within the “Value Tolerance” range of the new value for the entire “Stable Time”.

8.4.3.2 Database Logic Settings

Scan Rate

Defines the scan cycle time in milliseconds (50ms minimum) of the database logic processing task. All operations are evaluated for execution in sequential order at this frequency. Note that this does not necessarily mean that each operation is guaranteed to execute every scan cycle: only that it will be evaluated as to whether or not it should execute. Namely, if an “Enable Trigger” element is added to an operation, then the trigger must evaluate to “true” for the operation to execute during that scan cycle. Refer to section 8.4.3.3 for more information on Enable Trigger behavior.

8.4.3.3 Enable Trigger

Each database logic operation can optionally include an “Enable Trigger” element, which provides dynamic conditional execution capabilities. By default (i.e. if an enable trigger element is not added to the operation), each operation is automatically triggered to execute every scan cycle. If it is desired for an operation to execute conditionally, however, then an enable trigger element can be added to it. The enable trigger element defines an “Enable Value”, which specifies a byte-size trigger value that can reside at any location in the internal database. When implemented, the enable value is evaluated every scan cycle: if this value is non-zero (or zero when the “Inverted” Trigger Option is used), the operation will execute.

The enable value itself can be modified by any communication driver currently running on the device, which enables networked devices to dynamically control the execution of database logic operations. The enable value can also be the output result of other database logic operations. While the output of any database operation can be used for this purpose, such a scenario may most typically use the output of a “compare” operation in order to control whether or not other operations should execute (e.g. execute a certain operation only when some process variable is greater than a certain value, etc.) Allowing the conditional execution of database logic operations to be based on data values obtained via communications or as a result of other database logic operations



enables the construction of flexible, hierarchical and dynamic data evaluation and manipulation engines.

Enable Value Database Address

Enter the database address which specifies the byte-size trigger value.

8.4.3.3.1 Trigger Options

The enable trigger can perform basic logic on the enable value to determine if an operation should execute using a variety of trigger options. These settings determine what logic should be applied to the enable value when evaluating whether or not the operation should execute.

Inverted

Specifies whether the enable logic should be inverted. This applies to both the evaluation of whether or not the operation should execute as well as resetting the enable value when the auto reset option is used.

Auto Reset

Allows the enable value to be automatically reset upon completion of the operation. The actual value written to the enable value depends on the other trigger options selected. If no options are selected, a value of 0 is written to the enable value. If the inverted option is used, a value of 1 is written to the enable value. If the bitmask option is used, each bit selected in the bitmask is written to a 0 (or a 1 if the inverted option is used) in the enable value.

Bitmask

If this option is used, it selects which bits in the enable value to evaluate. Every selected bit in the enable value must be 1 (or 0 when the inverted option is used) for the operation to execute.

8.5 Service Objects and Diagnostics Objects

A service object is used by the gateway to make requests on a network when a master/client protocol is enabled. Each service object defines the services (read and/or write) that should be performed on a range of network objects of a common type. The data from read requests is mirrored in the database starting at a user-defined address (if a read function is enabled). When a value within that address range in the database changes, a write request is generated on the network (if a write function is enabled). Specific service object configuration depends on the protocol selected: refer to the protocol-specific section of this manual for further details.

Master/client drivers commonly also provide the ability to debug configured service objects while the driver is running by way of optional diagnostics objects. Where supported, diagnostics objects can be added to each service object, and a database address can be designated at which to store the status information. The diagnostics object is a 16-byte structure containing elements such as a

transmission counter, receive counter, receive error counter, current status, and the last error of the defined service object. This information is detailed in Appendix B: Diagnostics Objects. Because the diagnostics object resides in the database alongside the service object's process data, it can also be accessed over any supported network by mapping appropriate network elements to the corresponding database addresses.

Alternatively, the diagnostics objects can be viewed within the Configuration Studio by selecting a device in the **Project** panel and then either clicking on or hovering over the **Diagnostics** panel. Diagnostics objects are automatically added to the **Diagnostics** panel, and are disseminated and displayed in plain text for easy interpretation. For online devices, diagnostics objects are updated in real-time and all counters can be reset by selecting one or more entries in the list and clicking the **Reset Selected Counters** button.

9. Interacting With the Filesystem

The gateway's on-board filesystem is used to store files for use by the application firmware. Currently, the application firmware's main use of the filesystem is to store XML-encoded configuration files that dictate the characteristics of the various protocols. Each protocol that requires configuration will have its own XML file stored on the filesystem. For easy identification, the filename will begin with the corresponding protocol which it configures. For example, a BACnet configuration file's filename will begin with "bacnet", and an EtherNet/IP file will begin with "eip".

Whenever the configuration for a specific protocol is completed, it is suggested that a backup copy of the configuration file be downloaded from the unit to a PC. One reason for this is in case it becomes necessary to restore a previous configuration at a later time. Another reason is that it may be desirable to load multiple units with the same configuration, as a downloaded configuration file can be uploaded again to any compatible unit, allowing the user to easily clone multiple units with the same configuration. While the majority of the configuration files that are available via FTP are recreated whenever a configuration is downloaded via USB from the configuration studio, some of the files are available solely over Ethernet. For example, the dashboard and alarm configuration can only be configured via the embedded web server, and therefore these specific configuration files are only available via FTP.

Each time the gateway boots up, it will interrogate the filesystem for the configuration files required by the protocols currently operating in the unit. If it does not find a required file, it will create one and initialize it with factory-default values. Therefore, if it is ever desired to reset a protocol's configuration to factory-default values, this can be easily accomplished by simply deleting the appropriate configuration file from the filesystem and rebooting the unit.

Note that the application firmware uses specific filenames for the configuration files. This means that if a file with a different filename is loaded onto the unit, it will be stored correctly, but will not be used by the application firmware. Similarly, if an existing configuration file's filename is changed, then the unit will again create a default configuration file at next boot-up, which will be stored in the filesystem alongside the file with the changed name.

Configuration files are only read by the protocol drivers at unit boot-up. Therefore, if a new configuration file is loaded onto a unit's filesystem, that unit must be rebooted for the configuration file's settings to take effect. Rebooting a unit can be performed by:

- power-cycling the gateway,
- selecting "Reset Device" from the configuration studio, or
- selecting the "Reboot Device" button in the Finder tab of the configuration studio

Interacting with the filesystem is performed by use of the File Transfer Protocol (FTP). Using FTP allows the user to interact with the files on the gateway's filesystem in the same manner as though they were traditional files stored on a

local or remote PC. While there are many different FTP applications available, the following sections will provide general examples of using some of the most commonly-available ones.

9.1 Using FTP with Windows Explorer

To use FTP with Microsoft Windows Explorer, first open either “Windows Explorer” or “My Computer”. Refer to Figure 10. Please note that the indicated procedure, prompts and capabilities outlined here can vary depending on such factors as the installed operating system, firewalls and service packs.

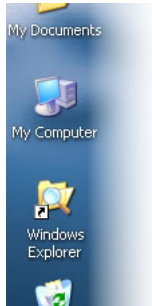

Figure 10: Accessing Windows Explorer

In the “Address” field, type in “ftp://root@” and then the IP address of the target gateway (if the user name has been changed from its default, then replace “root” in “ftp://root@” with the new user name.) Refer to Figure 11.

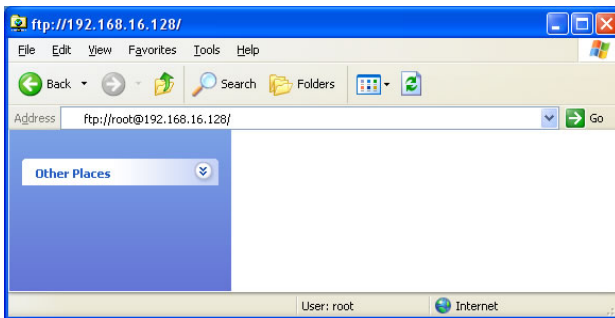

Figure 11: FTP Navigation with Windows Explorer

You will then be presented with an authentication dialog (refer to Figure 12.) The user name will already be filled-in. Enter the case-sensitive password (default is “icc”) and click “Log On.”

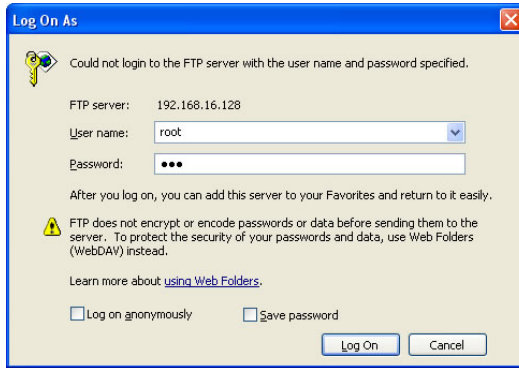

Figure 12: FTP Authentication

Windows Explorer will then display the filesystem’s contents (refer to Figure 13.) You can now perform normal file manipulation actions on the available files (cut, copy, paste, open, rename, drag-and-drop transfers etc.) in the same manner as though you were manipulating any traditional file stored on your computer’s hard drive.

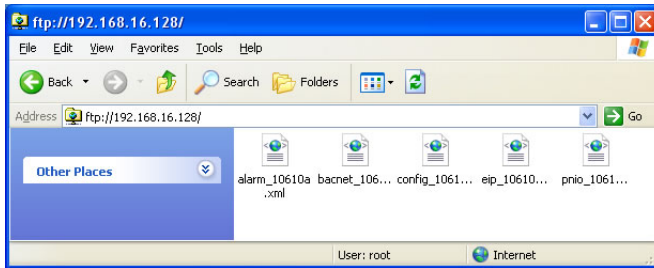

Figure 13: File Access with Windows Explorer

9.2 Using FTP with a Windows Command Prompt

To use FTP with a Windows command (DOS) prompt, first open a command prompt by either selecting *Start...All Programs...Accessories...Command Prompt*, or by selecting *Start...Run* and typing “cmd” in the “Run” dialog.

Once the command prompt opens, type “ftp” and the IP address of the target gateway. The FTP client will connect to the unit and then prompt for the username and case-sensitive password (defaults are “root” and “icc”, respectively). Upon successful entry of the authentication information, you will be presented with an “ftp>” prompt. Refer to Figure 14.

```

C:\WINDOWS\system32\cmd.exe - ftp 192.168.16.128

Z:\>ftp 192.168.16.128
Connected to 192.168.16.128.
220 NET+OS 7.3 FTP server ready.
User (192.168.16.128:(none)): root
331 User root OK, send password.
Password:
230 Password OK.
ftp>
  
```

Figure 14: FTP Initiation and Authentication

At this point, you can use standard Unix-style file and directory manipulation commands to perform such actions as listing files (Figure 15), copying files to your computer (Figure 16), and copying files to the unit (Figure 17).

```

C:\WINDOWS\system32\cmd.exe - ftp 192.168.16.128

ftp> ls
200 PORT command Ok.
150 File Listing Follows in ASCII mode
config_10610a.xml
alarm_10610a.xml
pnio_10610a.xml
bacnet_10610a.xml
sip_10610a.xml
226 Transfer complete.
ftp: 89 bytes received in 0.19Seconds 0.48Kbytes/sec.
ftp>
  
```

Figure 15: Listing Files with "ls" Command

```

C:\WINDOWS\system32\cmd.exe - ftp 192.168.16.128

ftp> get pnio_10610a.xml
200 PORT command Ok.
150 About to open data connection.
226 Transfer complete.
ftp: 1165 bytes received in 0.23Seconds 4.98Kbytes/sec.
ftp>
  
```

Figure 16: Copying a File from the Unit With "get" Command

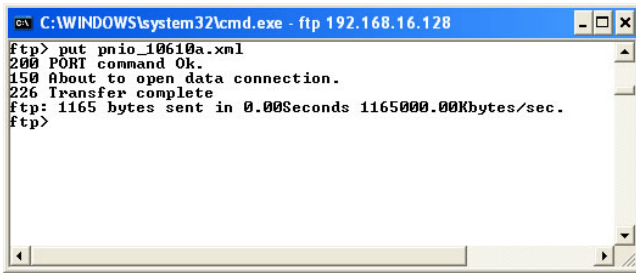

Figure 17: Copying a File to the Unit With "put" Command

9.3 Using FTP with Core FTP LE

Core FTP LE (Lite) is a 3rd-party FTP application that can be downloaded for free from <http://www.coreftp.com>. Core FTP is just one example of the various commercial and freeware FTP client applications available on the internet.

After installing Core FTP LE, run the program. If the “Site Manager” window (Figure 18) does not automatically open, open it by choosing “File...connect”.

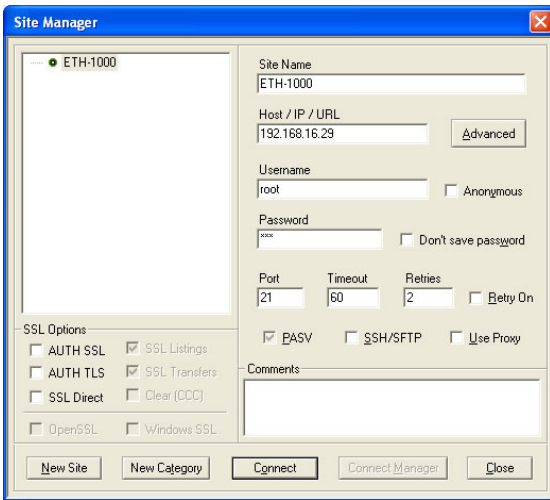



Figure 18: Core FTP Site Manager

Click on the “New Site” button, then enter a Site Name, IP Address, user name (default is “root”) and case-sensitive password (default is “icc”). The “Port”, “Timeout”, and “Retries” fields should already contain the default values. Click the “Connect” button when done.

Core FTP LE will then try to connect and authenticate to the FTP server, and if successful, will populate the right-hand side of the main page with the unit’s filesystem contents. Refer to Figure 19.

Files can be easily downloaded from the unit by choosing the appropriate destination folder on your computer in the left-hand side of the main page, choosing the file to download, and then clicking the “download”  button in the right-hand (source) side. Similarly, files can be easily uploaded to the unit by choosing the file to upload and then clicking the “upload”  button in the left-hand (source) side of the main page.

Like most 3rd-party FTP client applications, Core FTP LE has a wide array of configuration and file management capabilities, which are beyond the scope of this manual. Refer to the program’s Help file for more detailed instructions.

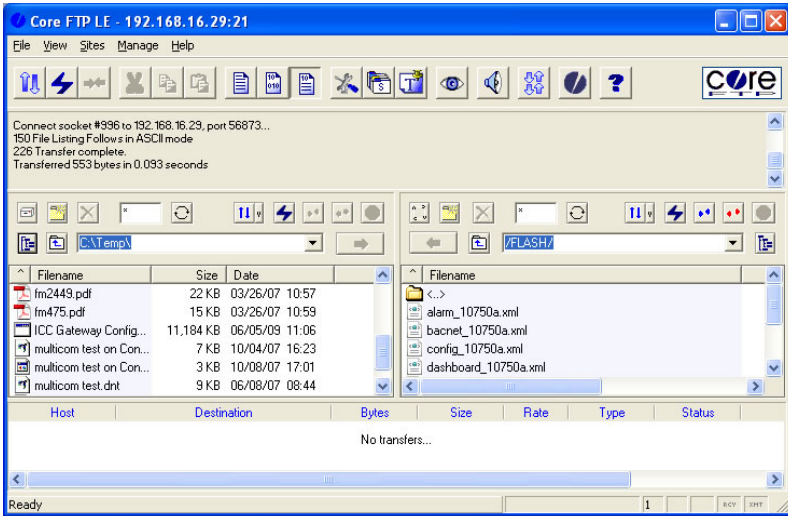

Figure 19: Core FTP in "Connected" State

10. Embedded Web Server

10.1 Overview

The gateway's embedded web server (also known as an HTTP server) provides access to the gateway's data in a graphical manner with web browsers such as Microsoft Internet Explorer or Mozilla Firefox. In this way, the gateway can be monitored from across the room or from across the globe.

In order to view the gateway's web page, the free Adobe® Flash Player browser plug-in is required. If the plug-in is not already installed on your computer, then your browser will automatically be redirected to the appropriate Adobe download web site when you initially attempt to access the gateway's web page.

Alternatively, the plug-in can be downloaded directly by going to <http://www.adobe.com>, and choosing the "get Adobe Flash Player" link. Always ensure that you have the latest version of the Flash Player installed: if some aspect of the web page does not appear to be displayed properly, installing the latest Flash Player update usually resolves the problem.

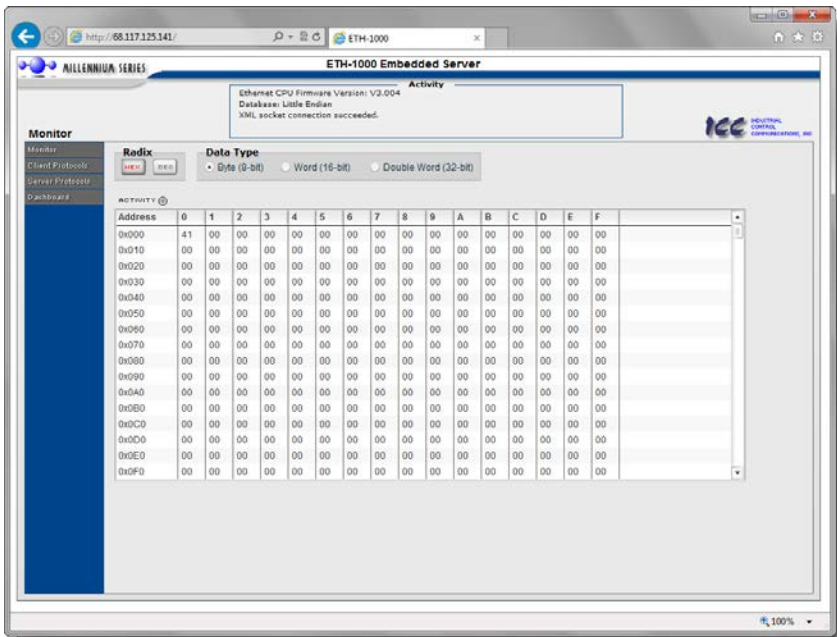

Figure 20: Embedded Web Server

To access the gateway's embedded web server, directly enter the target unit's IP address into the address (URL) field of your web browser. Refer to Figure 20 for a representative screenshot of the web server interface.

In order to access the web server and view the parameter values, destination TCP ports 80 and 2000 must be accessible from the client computer. If an “XML socket connection failed” error message is displayed in the activity window, and no database values are shown, this is typically indicative of port 2000 being blocked by a firewall or Ethernet router situated between the client computer and the gateway.

10.2 Authentication

For security, the gateway requires valid user authentication whenever the web page is accessed. The authentication request will appear as a browser popup box that will request entry of a user name and password. Refer to Figure 21.

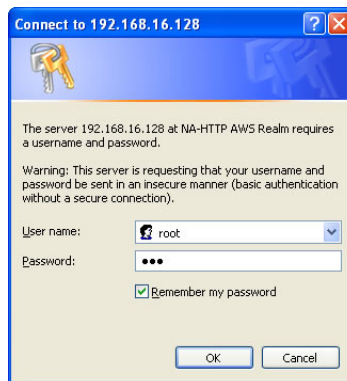

Figure 21: Web Server Authentication

The factory-default user name is “root”, and the password is “icc”. Note that the username and password are case-sensitive, and that once authenticated, the authentication will remain in effect from that point until all browser windows are closed. The authentication credentials can also be changed from their default settings (refer to section 8.3.1.)

10.3 Activity Panel

Figure 22 shows the Activity panel, which is located at the top of the web page. This panel displays various informational messages regarding the status of the gateway or web browser session.

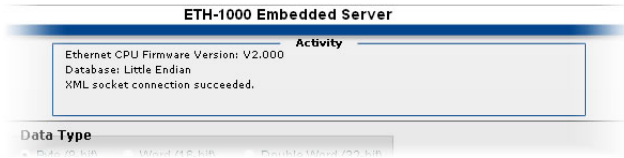

Figure 22: Activity Panel

10.4 Navigation Menu Tree

The web interface is structured as a navigation menu tree accessible on the left-hand side of the web page, where each menu contains information common to a specific feature or protocol. Refer to Figure 23. To change to a different configuration menu, just click on the title of the menu you wish to view. Some menus can be expanded to display submenus. The title of the currently-selected menu appears above the navigation menu tree.

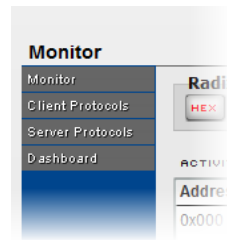

Figure 23: Navigation Menu Tree

10.5 Monitor Menu

Refer to Figure 20.

10.5.1 Activity Indicator

An “activity” indicator is located in the upper-left hand corner, which blinks periodically to show the status of data communication between the web browser and the gateway. If you do not observe the activity indicator blink at all for several seconds or more, it is possible that the web browser may have lost contact with the web server due to a device reset or a network problem: to reestablish communications, click “refresh” on your web browser.

10.5.2 Database

The database displays the live values from the associated device's internal database. The alignment (byte, word or double word) and radix (hex or decimal) of the displayed data can be adjusted via the appropriate controls in the “Radix” and “Data Type” selection groups. Database values can also be directly edited by clicking on the desired location and entering the desired value.

10.5.2.1 Radix Selection

The radix selection buttons provide the ability to change the data display and entry radix between decimal and hexadecimal formats.

When “DEC” is selected, the current values will be displayed in decimal, and modified values must be entered in decimal format.

Similarly, when “HEX” is selected, the current values will be displayed in hexadecimal, and modified values must be entered in hexadecimal format.

10.5.2.2 Data Type Selection

The alignment of the data displayed can be set to byte (8-bit), word (16-bit), or double word (32-bit). To change the data type, select the radio button of the desired type: the database columns and displayed values will be automatically readjusted according to the selection.



10.6 INCON Client Menu

Please contact Franklin Fueling or ICC for details pertaining to INCON client driver configuration.

10.7 BBMD Server Menu

The BBMD server menu allows active monitoring of the BACnet/IP BDT (Broadcast Distribution Table) and FDT (Foreign Device Table). Refer to Figure 24. For more information on BBMD configuration and usage details, refer to the separate BBMD driver documentation.

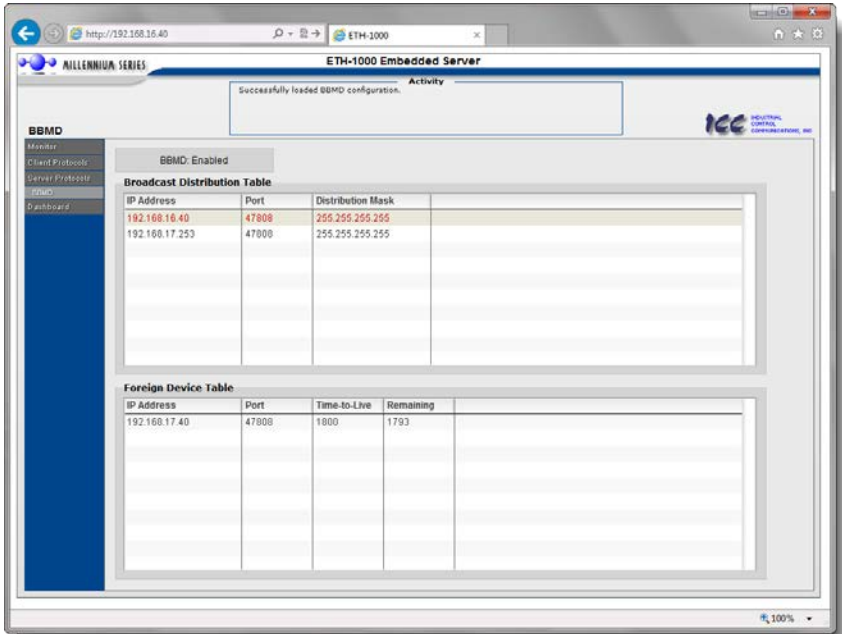

Figure 24: BBMD Server Status

10.7.1 BBMD Status

If the BBMD driver is enabled, the status will display “BBMD: Enabled”. Otherwise, the status will display “BBMD: Disabled”.

10.7.2 Broadcast Distribution Table (BDT)

In order for the BBMD to be effective, all BBMD entries must be included in the BDT. The BDT must be identical on all BBMDs.

IP Address: IP address of the BBMD.

Port: UDP port being used to receive BACnet/IP packets.

Distribution Mask: Used to determine the routing method to forward packets.

10.7.3 Foreign Device Table (FDT)

The Foreign Device Table shows the foreign devices that are currently registered with the BBMD. The web page must be refreshed to update the FDT.

IP Address: IP address of the foreign device.

Port: UDP port being used to receive BACnet/IP packets.

Time-to-Live: The time (in seconds) within which a foreign device must re-register.

Remaining: The actual remaining time (in seconds) before the foreign device entry is purged from the FDT if no re-registration occurs.

10.8 Dashboard Menu

The Dashboard Menu provides access to a variety of gauges, meters and graphs that can be configured to provide an at-a-glance graphical overview of critical application variables in real-time. A total of 10 gauge windows are available (four at a time), and each gauge panel can be configured to display any database value via one of six different gauge types. User-defined engineering units, data type, scaling and range limits are also configurable. Refer to Figure 25.

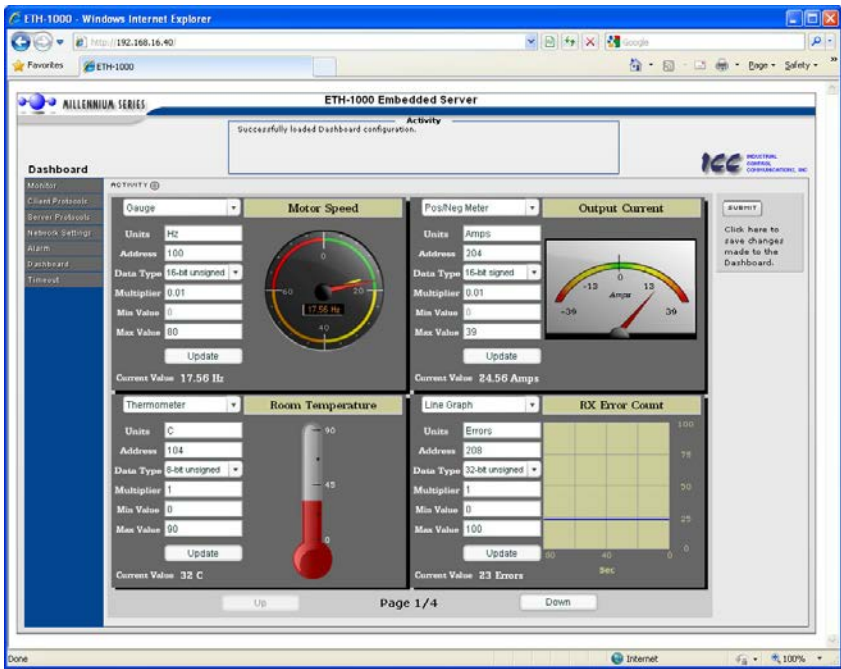

Figure 25: Dashboard Menu

10.8.1 Gauge Panel Navigation

Figure 26 shows the two buttons that provide for navigation of the gauge windows. Gauge windows are displayed four at a time in the Dashboard menu, and by clicking the “Up” or “Down” buttons, the gauge windows will scroll in the corresponding direction, two at a time.

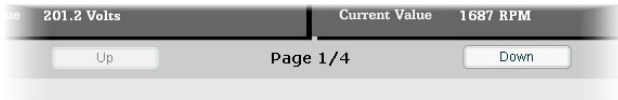

Figure 26: Gauge Panel Navigation

10.8.2 Gauge Panel Configuration

Each of the gauge windows can be independently configured to display database values with a variety of flexible configuration options. While the behavior and presentation may vary slightly depending on the specific gauge chosen, all of the gauges share the following common elements (refer to Figure 27 for an example):

Gauge Selector: A drop-down selection box in the upper left-hand corner of the gauge panel, which allows the user to select the type of gauge that will be displayed.

Title: A text entry box located above the gauge, in which the user can enter a descriptive gauge title comprised of up to 16 characters.

Units: A text entry box in which the user can enter an engineering units string comprised of up to 8 characters. This units string will be appended to all locations in the gauge panel that display the designated current value.

Address: The designated database address whose value is to be reflected on the gauge. The special address designation of “-1” disables a gauge, and is the default address setting for all gauges (i.e. all gauges are disabled by default.)

Data Type: Designates the data type (size and signed vs. unsigned) of the data read from the configured address.

Multiplier: The multiplier value is a floating-point number that is used to scale the raw value contained in the database. As its name suggests, the multiplier value is multiplied by the current raw value in order to calculate the gauge's indicated value. Negative multiplier values can also be used if desired.

Min Value: The gauge's minimum indicated value. Negative values can be used if desired (e.g. if a negative Multiplier attribute is used to generate a negative indicated value). Not all gauges allow adjustment of the min value.

Max Value: The gauge's maximum indicated value. Similar to the Min Value attribute, negative values can be used if desired. Indicated value characteristics can even be inverted by setting the Max Value attribute to a value less than the Min Value attribute.

Update Button: Clicking the update button will apply the current configuration attribute settings to the gauge. Note, however, that simply updating the gauge's current display properties does not write these settings to the gateway's filesystem. To save the current configuration of all the gauge windows to the filesystem, the Dashboard menu's “submit” button must be selected (refer to section 10.8.4).

Current Value: The current indicated value is numerically displayed with the configured Units string at the bottom of each gauge panel.

The following is a summary of the different available gauge types:

Gauge: Refer to Figure 27. This type of meter implements a rotary dial-type display format. The indicated value and units are shown numerically on the face of the gauge, and via the red indicator needle. The yellow needle shows the previous indicated value, thereby providing a simple historical reference. The “Min Value” attribute is not configurable; this gauge always starts at 0.

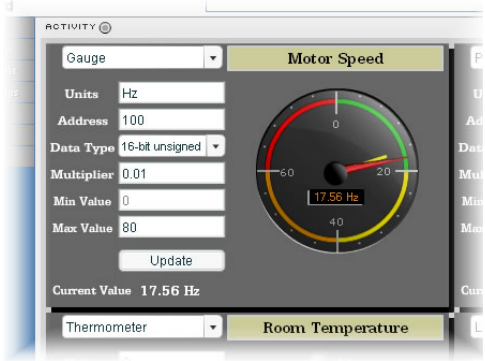

Figure 27: Gauge

BarGraph: Refer to Figure 28. This type of meter implements a linear bar graph display format. Hovering the mouse pointer over the red portion of the graph pops up a tooltip which displays the current indicated value and units.

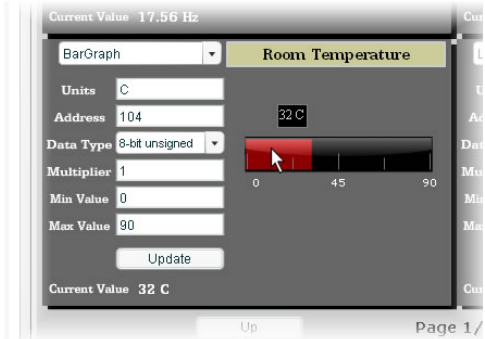

Figure 28: BarGraph

Meter: Refer to Figure 29. This type of meter implements a common panel meter-type display format. The units string is shown on the face of the meter.

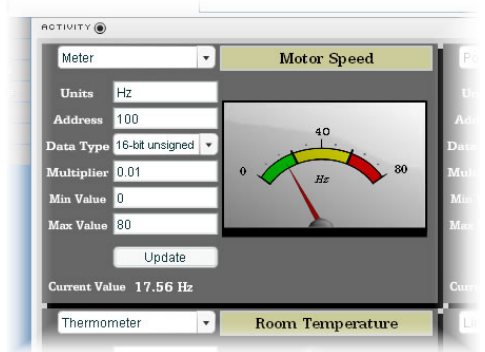

Figure 29: Meter

Pos/Neg Meter: Refer to Figure 30. Similar to the “meter” gauge, this type of meter also implements a common panel meter-type display format, but in this instance the indicated value can be positive or negative (two’s complement interpretation). Because the meter placard is always centered around zero, the “Min Value” attribute is not configurable, and the “Max Value” attribute is used for both the maximum positive indicated value as well as the maximum negative indicated value.

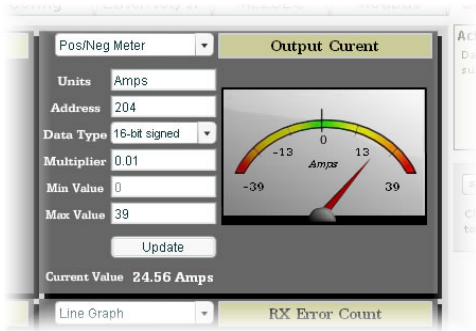

Figure 30: Pos/Neg Meter

Thermometer: Refer to Figure 31. This type of meter implements the universally-identifiable thermometer display format. Hovering the mouse pointer over the red “mercury” portion of the graph pops up a tooltip which displays the current indicated value and units.

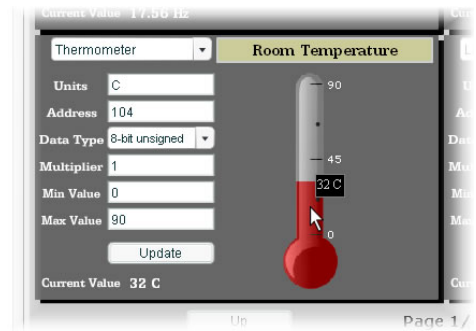

Figure 31: Thermometer

Line Graph: Refer to Figure 32. This type of graph implements a continuously-scrolling historical data logging line graph. Up to 80 seconds worth of historical data is available. Hovering the mouse pointer anywhere on the graph displays a vertical reference line at the corresponding time, and pops up a tooltip which displays the indicated value at that time.

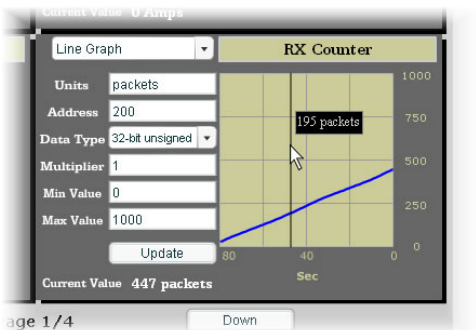

Figure 32: Line Graph

Gauge Usage Tip

At times, it may be convenient to zoom in on a particular gauge or meter in order to more clearly see the indicator, or to fill the computer screen with a particular gauge's image. This can be easily accomplished with the web browser's Flash Player plug-in by right-clicking on the gauge and selecting the desired zoom level (refer to Figure 33).

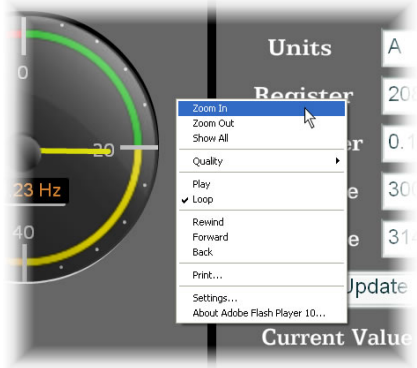

Figure 33: Zooming

10.8.3 Activity Indicator

An “activity” indicator is located in the upper-left hand corner, which blinks periodically to show the status of data communication between the web browser and the gateway. If you do not observe the activity indicator blink at all for several seconds or more, it is possible that the web browser may have lost contact with the web server due to a device reset or a network problem: to reestablish communications, click “refresh” on your web browser.

10.8.4 Submitting Changes

Whenever any of the gauge panel configuration items in the Dashboard menu have been changed, the “submit” button must be selected in order to write these settings to the gateway’s filesystem. Note that submitting the Dashboard menu configuration does not require rebooting of the gateway: the changes take effect immediately, and the gateway continues its operation without interruption.

11. RS-485 Drivers

The gateway supports a variety of serial drivers on its RS-485 port. For a list of supported protocols, refer to the *Millennium Series Supported Drivers List*. For detailed information on each protocol, refer to the specific protocol's driver manual.

12. Ethernet Drivers

The gateway supports a variety of Ethernet drivers on its Ethernet port. For a list of supported protocols, refer to the *Millennium Series Supported Drivers List*. For detailed information on each protocol, refer to the specific protocol's driver manual.

Unless otherwise noted, all Ethernet drivers operate independently, and therefore can operate simultaneously.

13. Troubleshooting

Although by no means exhaustive, the following table provides possible causes behind some of the most common errors experienced when using the gateway.

Problem	Symptom	Solution
The gateway will not turn on	All LEDs are off and the gateway shows no activity	<ul style="list-style-type: none"> • Confirm that power is connected to the correct inputs on the RS-485 terminal block. • If using Power-over-Ethernet (PoE), check that all cables are full inserted and that the Power Sourcing Equipment (PSE) is powered on. • If powering over USB, ensure the USB cable from the kit is used, and that the computer is able to supply sufficient power as a USB host device. • If firmware was being updated, it may have been corrupted. Unplug and reconnect the USB cable and run the Configuration Studio. Follow the Configuration Studio instructions to restore the firmware.
No communication between the RS-485 network and the gateway	The gateway's RS-485 TX and RX LEDs are blinking slowly, sporadically, or not at all	<ul style="list-style-type: none"> • Check connections and orientation of wiring between the network and the gateway. • Confirm that the protocol, baud rate, parity, and address settings on the RS-485 port match your network configuration.
No communication between the RS-485 network and the gateway	The gateway's RS-485 RX LED is solid ON	<ul style="list-style-type: none"> • The RS-485 signal wires are reversed. • Ensure that a network reference/ground wire is in place.

Problem	Symptom	Solution
<p>No communication between the Ethernet network and the gateway</p>	<p>Communications cannot be established, or the Ethernet “activity” LED flashes only infrequently or not at all</p>	<ul style="list-style-type: none"> • Confirm that the gateway is powered (refer to section 5.1). • Confirm that the destination IP address programmed into the controller equipment or computer matches that of the gateway, as displayed by the Finder utility. • Confirm that intermediate firewalls or routers have been configured to allow access to the interface via the applicable TCP/UDP ports. • If attempting to access the web server on a computer whose web browser is configured to use a proxy server, ensure that the proxy server is accessible to the computer, and that the gateway is accessible to the proxy server.
<p>No communication between the Ethernet network and the gateway</p>	<p>Communications cannot be established, the Ethernet “link” LED is off</p>	<ul style="list-style-type: none"> • Confirm that the gateway is powered (refer to section 5.1). • Try a different Ethernet cable. • Try a different port on the Ethernet switch.
<p>Firmware-generated error</p>	<p>The module status LED is flashing red: the number of times the LED flashes indicates an error code</p>	<ul style="list-style-type: none"> • A 6-4-2 flash code indicates the Ethernet coprocessor firmware is corrupted. Follow the instructions for “Recovering a Wired Ethernet Device’s Firmware Via TFTP” found in the Documents section at http://www.iccdesigns.com. • An 8-1-6 flash code indicates the gateway is in USB to Serial Pass-Through mode. All other functionality of the device is disabled. • Any other number of flashes indicates an internal device error. Record the blink sequence and contact ICC for further assistance.
<p>The device will not communicate to the Configuration Studio via USB</p>	<p>The USB cable is plugged into both the PC and the device, but the module status LED is not flashing green: the Configuration Studio may indicate a communication error</p>	<ul style="list-style-type: none"> • Unplug and reconnect the USB cable. • Try a different USB cable. • Try a different USB port on the computer. • Reinstall the Configuration Studio. • Reinstall the USB device drivers (contact ICC for assistance).

14. Appendix A: Database Endianness

A key feature of the Millennium Series gateways is the ability to change the byte order storage scheme for data in the database between big endian and little endian. The database endianness is the convention used to store multi-byte data to or retrieve multi-byte data from the database. The selected endianness affects the end-to-end consistency of multi-byte data between the two networks on the gateway.

To better understand how this byte-ordering scheme works, the following explains how the gateway stores and retrieves multi-byte data to and from the database. Data is stored into the database starting at the low address and filled to higher addresses. The endianness determines whether the most-significant or least-significant bytes are stored first.

Let's look at some examples that demonstrate this. Figure 34 shows how the hex value 0x12345678 is stored into the database using a big endian byte order. Since the hex value 12 is the most significant byte, it is stored at address "a", the lowest address.

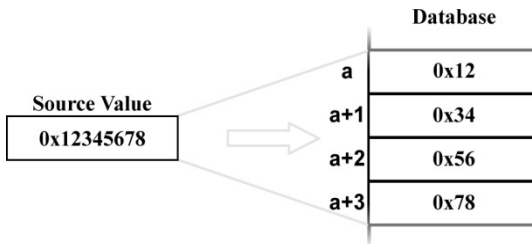

Figure 34: Big Endian Storage

Figure 35 demonstrates how the hex value 0x12345678 is stored into the database using a little endian byte order. Since the hex value 78 is the least significant byte, it is stored at the lowest address.

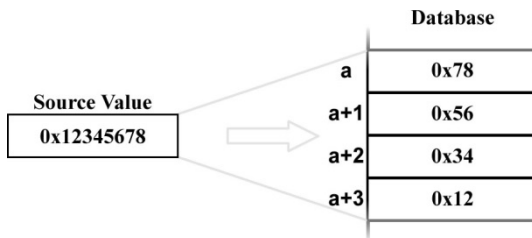

Figure 35: Little Endian Storage

Similarly, data is retrieved from the database starting at the low address. The endianness decides whether the first byte is interpreted as the least-significant byte or the most-significant byte of the multi-byte number.

Here are some examples that demonstrate this. Figure 36 shows how the hex value 0x12345678 is retrieved from the database using a big endian byte order. Since the hex value 12 is at address “a”, the lowest address, it is the most significant byte.

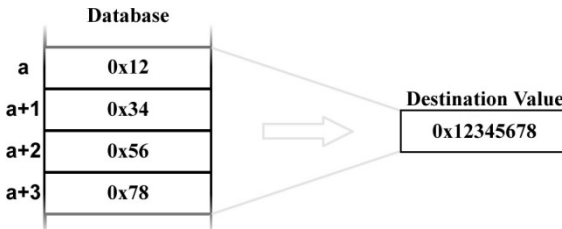

Figure 36: Big Endian Retrieval

Figure 37 demonstrates how the hex value 0x12345678 is retrieved from the database using a little endian byte order. Since the hex value 78 is at the lowest address, it is the least significant byte.

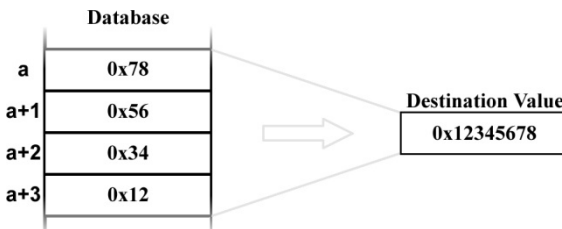

Figure 37: Little Endian Retrieval

The above examples illustrate the data movement to and from the gateway’s internal database. This idea helps explain the data movement, as a whole, from one port to the other on the gateway between two different networks. Because networks vary in the manner that they exchange data, endianness selection must be part of the gateway’s configuration in order to ensure coherent multi-byte data exchange. There are two data exchange methods used by the supported networks of the gateway.

The first method is used in those networks that define a byte order for how to interpret multi-byte data within an array of bytes. PROFIBUS, for example, defines a big-endian order for multi-byte data, while DeviceNet defines a little-endian order for multi-byte data. These networks exchange I/O data by means of a “bag of bytes” approach, whereas the gateway need not concern itself with where individual values are delimited within the array of bytes itself (as this is determined by the sending or receiving nodes on the networks). The bytes are

simply stored into the database in the order they were received. Gateway endianness selection therefore has no effect on data storage or retrieval with a “bag of bytes” protocol driver.

The other method is that used by networks that exchange data by means of an “object value” system, whereas data is exchanged by addressing a certain object to read or write data. Modbus for example, uses registers, while BACnet uses objects such as analog values to exchange data. When multi-byte values are received by the gateway, the bytes must be stored into the database in the order defined by the endianness selected. Likewise, when retrieving multi-byte values from the database for the gateway to transmit, the endianness selected will determine how the data is reconstructed when read from the database.

The selection of the correct byte ordering is crucial for coherent interaction between these two types of networks on the gateway. The following presents examples of how the database endianness affects end-to-end communication between networks and when each byte-ordering scheme should be used.

14.1 Modbus - PROFIBUS Example

This example shows the interaction between a network using an object value method (Modbus) and one using a bag of bytes method (PROFIBUS) to exchange data. The gateway reads holding registers 1 and 2 from the Modbus network, stores the data into the database, and then sends the 4 bytes of input data onto the PROFIBUS network. Figure 38 shows this data movement for the gateway’s database configured as big endian. Because the PROFIBUS specification defines multi-byte values within the byte array to be interpreted as big endian, it is recommended that the database be configured for big-endian byte order when using PROFIBUS. In the example, holding register 1 has a value of 0x1234 and holding register 2 has a value of 0x5678. When the PROFIBUS device receiving the input data from the gateway recombines the two pairs of 2-byte values, the resulting data is 0x1234 and 0x5678, thus successfully receiving the correct values for holding registers 1 and 2.

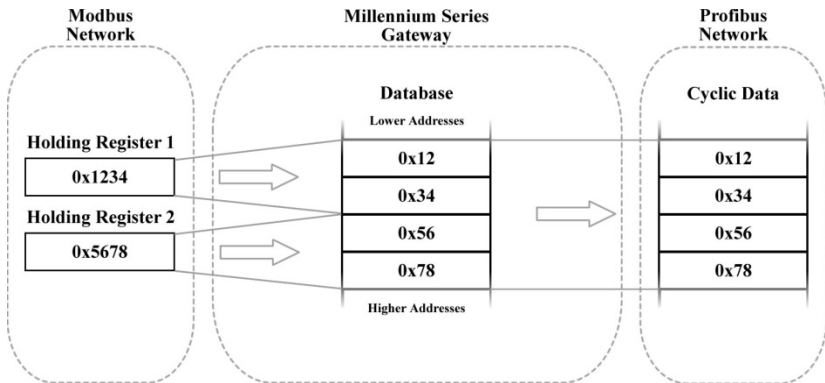

Figure 38: Modbus - PROFIBUS Big Endian

In contrast, Figure 39 shows the effects of configuring the database for little-endian byte order. Holding registers 1 and 2 again have values of 0x1234 and 0x5678, respectively. However, when the PROFIBUS device receiving the input data from the gateway interprets these values, the resulting pairs of 2-byte values become 0x3412 and 0x7856, thus receiving incorrect values for holding registers 1 and 2. Note that in both examples, the PROFIBUS network data is always identical, byte-for-byte, to the gateway's database. For this reason it is important to configure gateways that use a bag-of-bytes style network, such as the PBDP-1000, to use the same endianness as defined for that network.

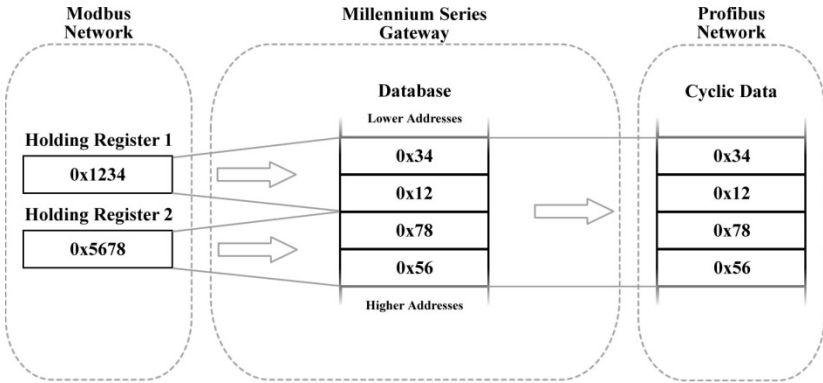

Figure 39: Modbus - PROFIBUS Little Endian

14.2 Modbus - DeviceNet Example

This example shows the interaction between a network using an object value method (Modbus) and one using a bag of bytes method (DeviceNet) to exchange data. The gateway reads holding registers 1 and 2 from the Modbus network, stores the data into the database, and then sends the 4 bytes of input data onto the DeviceNet network. Figure 40 shows this data movement for the gateway's database configured as little endian. Because the DeviceNet specification defines multi-byte values within the byte array to be interpreted as little endian, it is recommended that the database be configured for little-endian byte order when using DeviceNet. In the example, holding register 1 has a value of 0x1234 and holding register 2 has a value of 0x5678. When the DeviceNet device receiving the input data from the gateway recombines the two pairs of 2-byte values, the resulting data is 0x1234 and 0x5678, thus successfully receiving the correct values for holding registers 1 and 2.

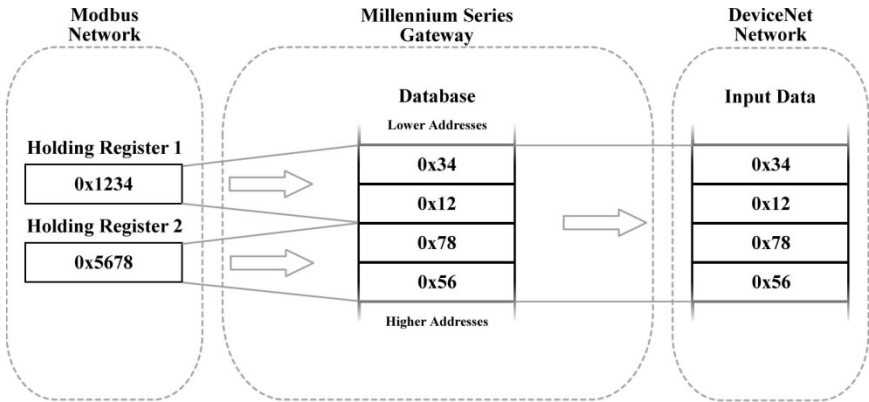

Figure 40: Modbus - DeviceNet Little Endian

In contrast, Figure 41 shows the effects of configuring the database for big-endian byte order. Holding registers 1 and 2 again have values of 0x1234 and 0x5678, respectively. However, when the DeviceNet device receiving the input data from the gateway interprets these values, the resulting pairs of 2-byte values become 0x3412 and 0x7856, thus receiving incorrect values for holding registers 1 and 2. Note that in both examples, the DeviceNet network data is always identical, byte-for-byte, to the gateway's database. For this reason it is important to configure gateways that use a bag-of-bytes style network, such as the DNET-1000, to use the same endianness as defined for that network.

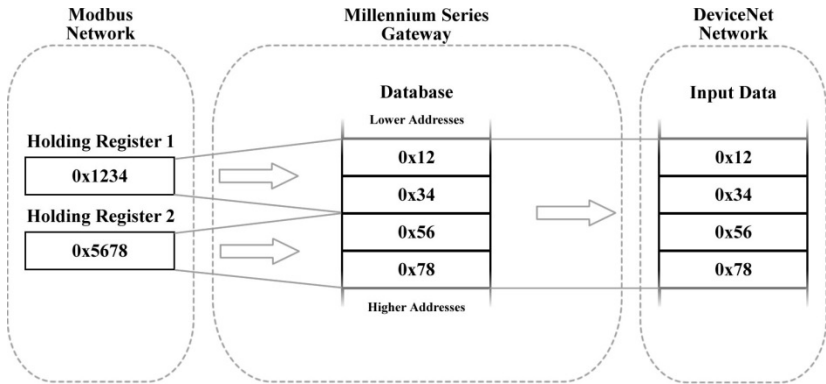

Figure 41: Modbus - DeviceNet Big Endian

14.3 BACnet - DeviceNet Example

This example is quite similar to the previous one as data is exchanged between an object-value style network (BACnet) and a bag-of-bytes style network (DeviceNet). The key difference is that in this example, BACnet Analog Value 0 is a 32-bit value, as opposed to two 16-bit Modbus registers. Here, the gateway

reads analog value 0 from the BACnet network, stores the data into the database, and sends the input data onto the DeviceNet network. Figure 42 demonstrates the data flow from the BACnet network to the DeviceNet network through a gateway configured to use a little endian database. Because the DeviceNet specification defines multi-byte values within the byte array to be interpreted as little endian, it is recommended that the database be configured for little-endian byte order when using DeviceNet. In the example, analog value 0 has a value of 0x12345678. When the DeviceNet device receiving the input data from the gateway interprets the 4 bytes, the resulting 4-byte value will be 0x12345678, thus successfully receiving the original value of the BACnet analog value object.

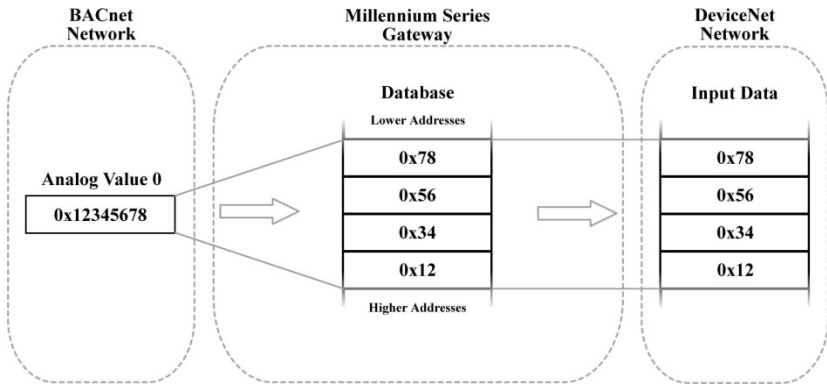

Figure 42: BACnet - DeviceNet Little Endian

Conversely, Figure 43 illustrates the consequences of configuring the database for big-endian byte order using this scenario. Once again, Analog Value 0 has a value of 0x12345678. But now, when the DeviceNet device interprets the 4 bytes of input data sent by the gateway, the resulting 4-byte value is 0x78563412, thus receiving an incorrect value for Analog Value 0. Note that in this example as well, the DeviceNet byte array is identical, byte-for-byte to the database. This example, in conjunction with the previous, demonstrates the dependence on the bag-of-bytes style networks for correct database endianness selection.

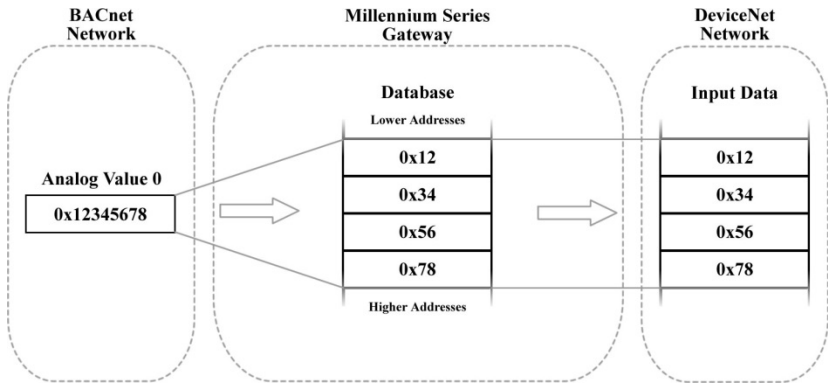

Figure 43: BACnet - DeviceNet Big Endian

14.4 BACnet - Modbus Analog Element Example

This example exhibits two networks that both use an object value scheme to exchange data. In this scenario, the database endianness is irrelevant if the data types are the same for both networks. This example shows communication between a BACnet network and a Modbus network using two 16-bit analog value BACnet objects and two 16-bit Modbus holding registers. As shown in Figure 44, the values from the BACnet network are stored into the database with big-endian byte ordering. Figure 45 shows the values from the BACnet network being stored into the database with little-endian byte ordering. Regardless of the byte-ordering scheme used, the two holding registers on the Modbus network receive the same values. Notice that in both cases, analog values 1 and 2 have values of 0x1234 and 0x5678, respectively, while holding registers 1 and 2 also have values of 0x1234 and 0x5678, respectively. The only difference between the two cases is how the data is being stored internally on the gateway itself.

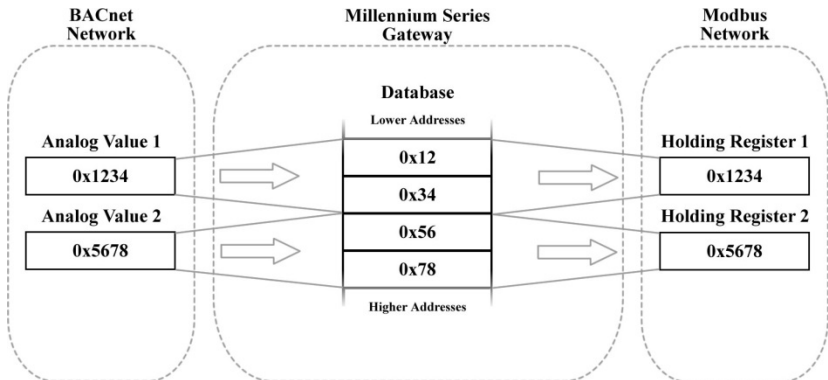

Figure 44: BACnet - Modbus (Analog Objects & Registers) Big Endian

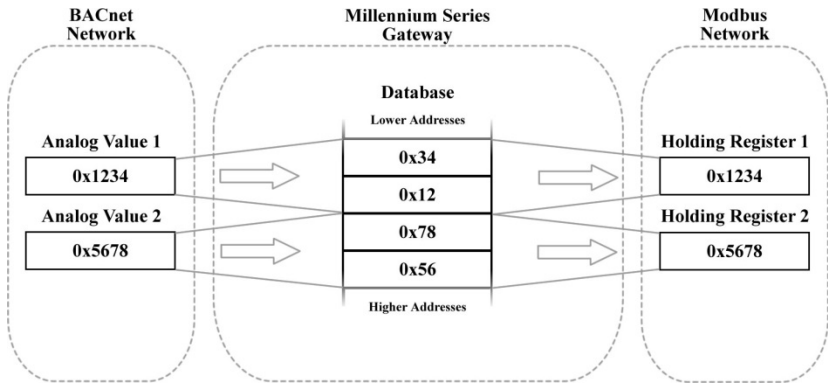

Figure 45: BACnet - Modbus (Analog Objects & Registers) Little Endian

14.5 BACnet - Modbus Binary Element Example

This example also contains two networks that both employ an object value method for exchanging data, but unlike the previous example, the database endianness does affect the end-to-end alignment of the data. In this example, communication is taking place between a BACnet network and a Modbus network using single-bit data elements. The BACnet side is using binary values 1 through 32, while the Modbus side is using coil status 1 through 32. The byte ordering of the database is significant because of the manner in which Modbus coils are mapped in the gateway. Coils (and input statuses) are mapped to registers, not addresses (refer to the Modbus driver documentation for more information). Since registers are 16-bit entities, the byte order of the registers (and by association, the coils), is affected by the endianness configured for the database. BACnet binary objects, however, are mapped on a byte-wise basis into the database.

When the database is configured for a little-endian byte order, binary values 1...8 corresponds to coils 1...8, binary values 9...16 corresponds to coils 9...16, and so on. This can be seen in Figure 46. Notice that the least significant bytes of the registers that the coils map to are placed in the lower memory addresses in the database. Because Modbus discretetes are mapped to registers in a bit-wise little-endian fashion, it is recommended that the database be little endian in this scenario so that bit-wise data will align between networks.

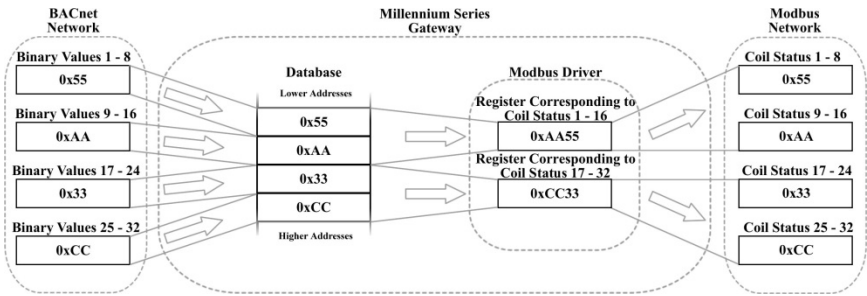

Figure 46: BACnet - Modbus (Binary Objects & Discretes) Little Endian

However, when the database is configured for a big-endian byte order, binary values 1...8 correspond to coils 9...16, binary values 9...16 correspond to coils 1...8, and so on. This can be seen in Figure 47. Since the most significant bytes of the Modbus registers that the coils map to are now mapped to lower addresses, the alignment between the two networks' bit-wise data is byte swapped. While this alignment can still be used, it is much more intuitive when the database is configured to be little endian.

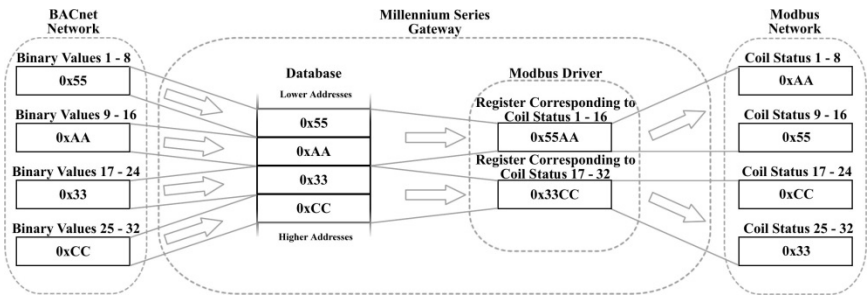

Figure 47: BACnet - Modbus (Binary Objects & Discretes) Big Endian

15. Appendix B: Diagnostics Objects

This section details the information that is enabled by adding a diagnostics object to a service object. Figure 48 diagrams the structure of this status information. Because this 16-byte structure resides in the database at a user-designated location, it can be accessed from any supported network or protocol in order to continuously determine the health and performance of the corresponding service object.

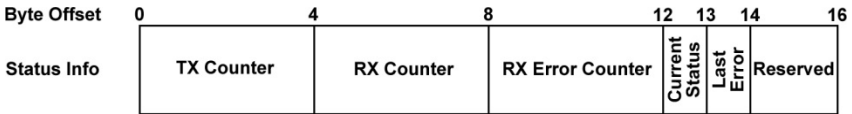

Figure 48: Diagnostics Object Format

TX Counter

A 32-bit counter that increments when the driver transmits a packet.

RX Counter

A 32-bit counter that increments when the driver receives a valid packet.

RX Error Counter

A 32-bit counter that increments when the gateway receives an error response packet, or when an error occurs upon reception of a packet.

Current Status

Indicates the status of the most-recently received packet. This field is updated each time the “RX Counter” or “RX Error Counter” increments. Refer to Table 3 for a list of supported codes.

Last Error

Indicates the last reception error that occurred. This field is updated each time the “RX Error Counter” increments. Refer to Table 3 for a list of supported codes.

Reserved

These two bytes are reserved for future use.

Table 3: Status / Error Codes

Status / Error Code (Hex)	Description
0x00	No Error
0xF0	Invalid Data Address
0xF1	Data Error
0xF2	Write To Read-Only
0xF3	Read From Write-Only
0xF4	Target Busy
0xF5	Target Error
0xF6	Cannot Execute
0xF7	Mode Error
0xF8	Other Error
0xF9	Memory Error
0xFA	Receive Error
0xFB	Invalid Function
0xFC	Invalid Packet
0xFD	Security Error
0xFE	Checksum Error
0xFF	Timeout Error



16. Appendix C: BACnet PICS

BACnet Protocol Implementation Conformance Statement (PICS)

Date: January 1, 2016
Vendor Name: ICC, Inc.
Product Name: Millennium Series Ethernet Gateway
Product Model Number: ETH-1000
Applications Software Version: V5.000
Firmware Revision: V5.000
BACnet Protocol Revision: 12
Product Description:

The ETH-1000 is an Ethernet / RS-485 multiprotocol gateway. This product supports native BACnet, connecting directly to the IP and/or MS/TP LAN using baud rates of 9600, 19200, 38400, 57600, 76800, and 115200. The device can be configured as a BACnet/IP client and/or BACnet/IP server, BBMD, and MS/TP client and/or MS/TP server.

BACnet Standard Device Profile (Annex L):

- BACnet Operator Workstation (B-OWS)
- BACnet Building Controller (B-BC)
- BACnet Advanced Application Controller (B-AAC)
- BACnet Application Specific Controller (B-ASC)
- BACnet Smart Sensor (B-SS)
- BACnet Smart Actuator (B-SA)

BACnet Interoperability Building Blocks Supported (Annex K):

- Data Sharing – ReadProperty-A (DS-RP-A)
- Data Sharing – ReadProperty-B (DS-RP-B)
- Data Sharing – ReadPropertyMultiple-B (DS-RPM-B)
- Data Sharing – WriteProperty-A (DS-WP-A)
- Data Sharing – WriteProperty-B (DS-WP-B)
- Data Sharing – WritePropertyMultiple-B (DS-WPM-B)
- Data Sharing – COV-B (DS-COV-B) (BACnet/IP only)
- Device Management – Dynamic Device Binding-A (DM-DDB-A)
- Device Management – Dynamic Device Binding-B (DM-DDB-B)
- Device Management – Dynamic Object Binding-B (DM-DOB-B)
- Device Management – DeviceCommunicationControl-B (DM-DCC-B)
- Device Management – ReinitializeDevice-B (DM-RD-B)

Segmentation Capability:

None

- Segmented requests supported Window Size _____
- Segmented responses supported Window Size _____



Standard Object Types Supported:

See "Object Types/Property Support Table" for object details.

Data Link Layer Options:

- BACnet IP, (Annex J)
- BACnet IP, (Annex J), Foreign Device
- ISO 8802-3, Ethernet (Clause 7)
- ANSI/ATA 878.1, 2.5 Mb. ARCNET (Clause 8)
- ANSI/ATA 878.1, RS-485 ARCNET (Clause 8), baud rate(s) _____
- MS/TP master (Clause 9), baud rate(s): 9600, 19200, 38400, 57600, 76800, 115200
- MS/TP slave (Clause 9), baud rate(s): _____
- Point-To-Point, EIA 232 (Clause 10), baud rate(s): _____
- Point-To-Point, modem, (Clause 10), baud rate(s): _____
- LonTalk, (Clause 11), medium: _____
- Other: _____

Device Address Binding:

Is static device binding supported? (This is currently for two-way communication with MS/TP slaves and certain other devices.) Yes No

Networking Options:

- Router, Clause 6 - List all routing configurations
- Annex H, BACnet Tunneling Router over IP
- BACnet/IP Broadcast Management Device (BBMD)
Does the BBMD support registrations by Foreign Devices? Yes No

Network Security Options:

- Non-secure Device - is capable of operating without BACnet Network Security
- Secure Device - is capable of using BACnet Network Security (NS-SD BIBB)
 - Multiple Application-Specific Keys:
 - Supports encryption (NS-ED BIBB)
 - Key Server (NS-KS BIBB)

Character Sets Supported:

Indicating support for multiple character sets does not imply that they can all be supported simultaneously.

- ANSI X3.4
- IBM™/Microsoft™ DBCS
- ISO 8859-1
- ISO 10646 (UCS-2)
- ISO 10646 (UCS-4)
- JIS C 6226

If this product is a communication gateway, describe the types of non-BACnet equipment/networks(s) that the gateway supports:

Refer to protocol-specific manuals for other supported protocols.



Object Types/Property Support Table

The following table summarizes the Object Types/Properties supported.

Property	Object Type									
	Dev	BI	BO	BV	AI	AO	AV	MSI	MSO	MSV
Object Identifier	R	R	R	R	R	R	R	R	R	R
Object Name	R	R	R	R	R	R	R	R	R	R
Object Type	R	R	R	R	R	R	R	R	R	R
System Status	R									
Vendor Name	R									
Vendor Identifier	R									
Model Name	R									
Firmware Revision	R									
App Software Revision	R									
Protocol Version	R									
Protocol Revision	R									
Services Supported	R									
Object Types Supported	R									
Object List	R									
Max APDU Length	R									
Segmentation Support	R									
APDU Timeout	W (10...65535)									
Number APDU Retries	W (0...10)									
Max Master	W (1...127)									
Max Info Frames	R									
Device Address Binding	R									
Database Revision	R									
Active COV Subscriptions ¹	R									
Present Value		R	W	W	R	W	W	R	W	W
Status Flags		R	R	R	R	R	R	R	R	R
Event State		R	R	R	R	R	R	R	R	R
Reliability		R	R	R	R	R	R	R	R	R
Out-of-Service		R	R	R	R	R	R	R	R	R
Number of States								R	R	R
Units					R	R	R			
Priority Array			R	R		R	R			
Relinquish Default			R	R		R	R			
COV Increment ¹					W	W	W			
Polarity		R	R							
Inactive Text		R	R	R						
Active Text		R	R	R						

¹ – BACnet/IP only

R – readable using BACnet services

W – readable and writable using BACnet services



INDUSTRIAL CONTROL COMMUNICATIONS, INC.

1600 Aspen Commons, Suite 210
Middleton, WI USA 53562-4720
Tel: [608] 831-1255 Fax: [608] 831-2045

<http://www.iccdesigns.com>

Printed in U.S.A